

Veritas Storage Foundation™ for Oracle® RAC 6.0.1 Installation and Configuration Guide - HP-UX

HP-UX

6.0.1

Veritas Storage Foundation™ for Oracle RAC Installation and Configuration Guide

The software described in this book is furnished under a license agreement and may be used only in accordance with the terms of the agreement.

Product version: 6.0.1

Document version: 6.0.1 Rev 4

Legal Notice

Copyright © 2015 Symantec Corporation. All rights reserved.

Symantec, the Symantec Logo, the Checkmark Logo, Veritas, Veritas Storage Foundation, CommandCentral, NetBackup, Enterprise Vault, and LiveUpdate are trademarks or registered trademarks of Symantec Corporation or its affiliates in the U.S. and other countries. Other names may be trademarks of their respective owners.

The product described in this document is distributed under licenses restricting its use, copying, distribution, and decompilation/reverse engineering. No part of this document may be reproduced in any form by any means without prior written authorization of Symantec Corporation and its licensors, if any.

THE DOCUMENTATION IS PROVIDED "AS IS" AND ALL EXPRESS OR IMPLIED CONDITIONS, REPRESENTATIONS AND WARRANTIES, INCLUDING ANY IMPLIED WARRANTY OF MERCHANTABILITY, FITNESS FOR A PARTICULAR PURPOSE OR NON-INFRINGEMENT, ARE DISCLAIMED, EXCEPT TO THE EXTENT THAT SUCH DISCLAIMERS ARE HELD TO BE LEGALLY INVALID. SYMANTEC CORPORATION SHALL NOT BE LIABLE FOR INCIDENTAL OR CONSEQUENTIAL DAMAGES IN CONNECTION WITH THE FURNISHING, PERFORMANCE, OR USE OF THIS DOCUMENTATION. THE INFORMATION CONTAINED IN THIS DOCUMENTATION IS SUBJECT TO CHANGE WITHOUT NOTICE.

The Licensed Software and Documentation are deemed to be commercial computer software as defined in FAR 12.212 and subject to restricted rights as defined in FAR Section 52.227-19 "Commercial Computer Software - Restricted Rights" and DFARS 227.7202, "Rights in Commercial Computer Software or Commercial Computer Software Documentation", as applicable, and any successor regulations. Any use, modification, reproduction release, performance, display or disclosure of the Licensed Software and Documentation by the U.S. Government shall be solely in accordance with the terms of this Agreement.

Symantec Corporation
350 Ellis Street
Mountain View, CA 94043

<http://www.symantec.com>

Technical Support

Symantec Technical Support maintains support centers globally. Technical Support's primary role is to respond to specific queries about product features and functionality. The Technical Support group also creates content for our online Knowledge Base. The Technical Support group works collaboratively with the other functional areas within Symantec to answer your questions in a timely fashion. For example, the Technical Support group works with Product Engineering and Symantec Security Response to provide alerting services and virus definition updates.

Symantec's support offerings include the following:

- A range of support options that give you the flexibility to select the right amount of service for any size organization
- Telephone and/or Web-based support that provides rapid response and up-to-the-minute information
- Upgrade assurance that delivers software upgrades
- Global support purchased on a regional business hours or 24 hours a day, 7 days a week basis
- Premium service offerings that include Account Management Services

For information about Symantec's support offerings, you can visit our website at the following URL:

www.symantec.com/business/support/index.jsp

All support services will be delivered in accordance with your support agreement and the then-current enterprise technical support policy.

Contacting Technical Support

Customers with a current support agreement may access Technical Support information at the following URL:

www.symantec.com/business/support/contact_techsupp_static.jsp

Before contacting Technical Support, make sure you have satisfied the system requirements that are listed in your product documentation. Also, you should be at the computer on which the problem occurred, in case it is necessary to replicate the problem.

When you contact Technical Support, please have the following information available:

- Product release level
- Hardware information

- Available memory, disk space, and NIC information
- Operating system
- Version and patch level
- Network topology
- Router, gateway, and IP address information
- Problem description:
 - Error messages and log files
 - Troubleshooting that was performed before contacting Symantec
 - Recent software configuration changes and network changes

Licensing and registration

If your Symantec product requires registration or a license key, access our technical support Web page at the following URL:

www.symantec.com/business/support/

Customer service

Customer service information is available at the following URL:

www.symantec.com/business/support/

Customer Service is available to assist with non-technical questions, such as the following types of issues:

- Questions regarding product licensing or serialization
- Product registration updates, such as address or name changes
- General product information (features, language availability, local dealers)
- Latest information about product updates and upgrades
- Information about upgrade assurance and support contracts
- Information about the Symantec Buying Programs
- Advice about Symantec's technical support options
- Nontechnical presales questions
- Issues that are related to CD-ROMs or manuals

Support agreement resources

If you want to contact Symantec regarding an existing support agreement, please contact the support agreement administration team for your region as follows:

Asia-Pacific and Japan customercare_apac@symantec.com

Europe, Middle-East, and Africa semea@symantec.com

North America and Latin America [supportolutions@symantec.com](mailto:supportsolutions@symantec.com)

Documentation

Product guides are available on the media in PDF format. Make sure that you are using the current version of the documentation. The document version appears on page 2 of each guide. The latest product documentation is available on the Symantec website.

<https://sort.symantec.com/documents>

Your feedback on product documentation is important to us. Send suggestions for improvements and reports on errors or omissions. Include the title and document version (located on the second page), and chapter and section titles of the text on which you are reporting. Send feedback to:

doc_feedback@symantec.com

For information regarding the latest HOWTO articles, documentation updates, or to ask a question regarding product documentation, visit the Storage and Clustering Documentation forum on Symantec Connect.

<https://www-secure.symantec.com/connect/storage-management/forums/storage-and-clustering-documentation>

About Symantec Connect

Symantec Connect is the peer-to-peer technical community site for Symantec's enterprise customers. Participants can connect and share information with other product users, including creating forum posts, articles, videos, downloads, blogs and suggesting ideas, as well as interact with Symantec product teams and Technical Support. Content is rated by the community, and members receive reward points for their contributions.

<http://www.symantec.com/connect/storage-management>

Contents

Technical Support	4
Section 1 Installation overview and planning	24
Chapter 1 Introducing Veritas Storage Foundation for Oracle RAC	25
About Veritas Storage Foundation for Oracle RAC	25
Benefits of SF Oracle RAC	26
About SF Oracle RAC components	27
About SF Oracle RAC optional features	28
About VCS notifications	29
About campus clusters	29
About global clusters	29
About Veritas Volume Replicator	30
About database management using SF Oracle RAC	30
About Cluster Manager (Java Console)	30
About Veritas Operations Manager	30
About Symantec Operations Readiness Tools	31
SF Oracle RAC cluster setup models	31
Typical configuration of four-node SF Oracle RAC cluster	32
Typical configuration of SF Oracle RAC clusters in secure mode	34
Typical configuration of VOM-managed SF Oracle RAC clusters	35
Typical configuration of SF Oracle RAC campus clusters for disaster recovery	35
Typical configuration of SF Oracle RAC global clusters for disaster recovery	38
Chapter 2 System requirements	40
Important preinstallation information	40
Hardware requirements	41
Supported operating systems	43
I/O fencing requirements	43

	Coordinator disk requirements for I/O fencing	43
	CP server requirements	43
	Supported database software	47
	Supported replication technologies for global clusters	47
	Discovering product versions and various requirement information	48
Chapter 3	Planning to install SF Oracle RAC	49
	Planning your network configuration	49
	Planning the public network configuration for Oracle RAC	50
	Planning the private network configuration for Oracle RAC	50
	Planning the storage	52
	Planning the storage for SF Oracle RAC	53
	Planning the storage for Oracle RAC	53
	Planning volume layout	57
	Planning file system design	58
	About planning to configure I/O fencing	58
	Typical SF Oracle RAC cluster configuration with disk-based I/O fencing	60
	Typical SF Oracle RAC cluster configuration with server-based I/O fencing	61
	Recommended CP server configurations	61
	Planning for cluster management	63
Chapter 4	Licensing SF Oracle RAC	65
	About Veritas product licensing	65
	About SF Oracle RAC licenses	66
	Setting or changing the product level for keyless licensing	68
	Installing Veritas product license keys	69
Section 2	Preparing to install and configure SF Oracle RAC	71
Chapter 5	Preparing to install SF Oracle RAC	72
	Preparing to configure server-based fencing for SF Oracle RAC	72
	Setting the umask before installation	73
	Synchronizing time settings on cluster nodes	73
	Mounting the product disc	73
	Setting up shared storage	74
	Setting the environment variables for SF Oracle RAC	74

	Optimizing LLT media speed settings on private NICs	75
	Guidelines for setting the media speed of the LLT interconnects	75
	Verifying the systems before installation	75
	About installation and configuration methods	76
	About the Veritas installer	77
Section 3	Installation of SF Oracle RAC using the script-based installer	80
Chapter 6	Installing SF Oracle RAC	81
	Installing SF Oracle RAC using the Veritas script-based installation program	81
Chapter 7	Configuring SF Oracle RAC	85
	Configuring the SF Oracle RAC components using the script-based installer	85
	Configuring the SF Oracle RAC cluster	87
	Creation of SF Oracle RAC configuration files	104
	Stopping and starting SF Oracle RAC processes	104
	Setting up disk-based I/O fencing using installsfrac	105
	Initializing disks as VxVM disks	105
	Identifying disks to use as coordinator disks	106
	Checking shared disks for I/O fencing	106
	Configuring disk-based I/O fencing using installsfrac	111
	Setting up server-based I/O fencing using installsfrac	114
Section 4	Installation of SF Oracle RAC using the Web-based installer	120
Chapter 8	Installing SF Oracle RAC	121
	Before using the Veritas Web-based installer	121
	Starting the Veritas Web-based installer	122
	Installing products with the Veritas Web-based installer	122

Chapter 9	Configuring SF Oracle RAC	125
	Configuring SF Oracle RAC using the Web-based installer	125
	Configuring SF Oracle RAC for data integrity using the Web-based installer	130
	Configuring disk-based fencing for data integrity using the Web-based installer	130
	Configuring server-based fencing for data integrity using the Web-based installer	132
	Online fencing migration mode using the Web-based installer	134
Section 5	Installation of SF Oracle RAC using operating system-specific methods	137
Chapter 10	Installing SF Oracle RAC	138
	Installing SF Oracle RAC using Ignite-UX	138
	Creating the Software Distributor (SD) bundle for SF Oracle RAC or the operating system and SF Oracle RAC	138
	Using Ignite-UX to perform a standalone SF Oracle RAC installation	139
	Using Ignite-UX to install SF Oracle RAC and the HP-UX operating system	141
Section 6	Post-installation and configuration tasks	142
Chapter 11	Verifying the installation	143
	Performing a postcheck on a node	143
	Verifying SF Oracle RAC installation using VCS configuration file	143
	Verifying LLT, GAB, and cluster operation	144
	Verifying LLT	144
	Verifying GAB	146
	Verifying the cluster	148
	Verifying the cluster nodes	149

Chapter 12	Performing additional post-installation and configuration tasks	153
	About enabling LDAP authentication for clusters that run in secure mode	153
	About configuring authentication for SFDB tools	154
	Configuring vxvdbd for SFDB tools authentication	154
	Configuring Veritas Volume Replicator	155
	Running SORT Data Collector to collect configuration information	155
Section 7	Upgrade of SF Oracle RAC	156
Chapter 13	Planning to upgrade SF Oracle RAC	157
	About types of upgrade	157
	Supported upgrade paths	158
Chapter 14	Performing a full upgrade of SF Oracle RAC using the product installer	160
	About full upgrades	160
	Preparing to perform a full upgrade to SF Oracle RAC 6.0.1	161
	Pre-upgrade tasks for migrating the SFDB repository database	165
	Upgrading to SF Oracle RAC 6.0.1	165
	Upgrading the HP-UX operating system	167
	Upgrading SF Oracle RAC using the Veritas script-based installation program	168
	Upgrading Veritas Storage Foundation for Oracle RAC using the Veritas Web-based installer	171
Chapter 15	Performing an automated full upgrade of SF Oracle RAC using response files	173
	Upgrading SF Oracle RAC using a response file	173
	Response file variables to upgrade Veritas Storage Foundation for Oracle RAC	174
	Sample response file for upgrading SF Oracle RAC	175
Chapter 16	Performing a phased upgrade of SF Oracle RAC	177
	About phased upgrade	177
	Performing phased upgrade of SF Oracle RAC from version 5.0 and later releases	178

	Step 1: Performing pre-upgrade tasks on the first half of the cluster	179
	Step 2: Upgrading the first half of the cluster	184
	Step 3: Performing pre-upgrade tasks on the second half of the cluster	185
	Step 4: Performing post-upgrade tasks on the first half of the cluster	188
	Step 5: Upgrading the second half of the cluster	189
	Step 6: Performing post-upgrade tasks on the second half of the cluster	190
Chapter 17	Performing a rolling upgrade of SF Oracle RAC	193
	About rolling upgrades	193
	Supported rolling upgrade paths	196
	Preparing to perform a rolling upgrade to SF Oracle RAC 6.0.1	196
	Performing a rolling upgrade using the installer	199
	Performing a rolling upgrade using the script-based installer	199
	Performing a rolling upgrade of SF Oracle RAC using the Web-based installer	202
Chapter 18	Upgrading from Storage Foundation High Availability products to SF Oracle RAC 6.0.1	206
	About upgrading from Storage Foundation High Availability products to SF Oracle RAC 6.0.1	206
	Upgrading from Storage Foundation High Availability products to SF Oracle RAC 6.0.1	207
Chapter 19	Migrating from single instance Storage Foundation for Oracle HA to SF Oracle RAC	209
	Migration overview	209
	Sample configuration before and after migration	210
	Migration requirements	211
	Before you migrate	211
	Migrating to SF Oracle RAC 6.0.1	212
	Migrating Storage Foundation for Oracle HA to SF Oracle RAC	212
	Migrating a single instance Oracle database to Oracle RAC database	213
	Completing post-migration tasks	217
	Sample configuration files	220

	VCS configuration file for Storage Foundation for Oracle HA	220
	Oracle initialization parameter file for Storage Foundation for Oracle HA	221
	tnsnames.ora for Storage Foundation for Oracle HA	222
	listener.ora for Storage Foundation for Oracle HA	223
	VCS configuration file for SF Oracle RAC	223
	Oracle initialization parameter file for SF Oracle RAC	226
	tnsnames.ora file for SF Oracle RAC	227
	listener.ora file for SF Oracle RAC	227
Chapter 20	Performing post-upgrade tasks	228
	Relinking Oracle RAC libraries with the SF Oracle RAC libraries	228
	Setting or changing the product license level	232
	Upgrading disk layout versions	232
	Upgrading CVM protocol version and VxVM disk group version	233
	Post upgrade tasks for migrating the SFDB repository database	234
	Migrating from a 5.0 repository database to 6.0.1	235
	Migrating from a 5.1 or higher repository database to 6.0.1	237
	After upgrading from 5.0.x and before migrating SFDB	239
Section 8	Installation and upgrade of Oracle RAC	240
Chapter 21	Before installing Oracle RAC	241
	Important preinstallation information for Oracle RAC	241
	About preparing to install Oracle RAC	241
	Preparing to install Oracle RAC using the SF Oracle RAC installer or manually	242
	Identifying the public virtual IP addresses for use by Oracle	244
	Setting the kernel parameters	244
	Verifying that depots and patches required by Oracle are installed	245
	Verifying the user <code>nobody</code> exists	245
	Launching the SF Oracle RAC installer	245
	Creating users and groups for Oracle RAC	247
	Creating storage for OCR and voting disk	252
	Configuring private IP addresses for Oracle RAC	269
	Verifying that multicast is functional on all private network interfaces	288
	Creating Oracle Clusterware/Grid Infrastructure and Oracle database home directories manually	289

	Setting up user equivalence	298
	Setting privileges for the DBA group	298
Chapter 22	Installing Oracle RAC	299
	About installing Oracle RAC	299
	Installing the Oracle Clusterware/Grid Infrastructure software	300
	Installing Oracle Clusterware/Grid Infrastructure using the SF Oracle RAC script-based installer	302
	Installing Oracle Clusterware/Grid Infrastructure using the SF Oracle RAC web-based installer	305
	Installing Oracle Clusterware/Grid Infrastructure using the Oracle Universal Installer	308
	Configuring LLT links in the GPNP profile	310
	Installing the Oracle RAC database software	310
	Installing the Oracle RAC database using the SF Oracle RAC script-based installer	311
	Installing the Oracle RAC database using the SF Oracle RAC Web-based installer	313
	Installing the Oracle RAC database using the Oracle Universal Installer	316
	Verifying the Oracle Clusterware/Grid Infrastructure and database installation	317
	Node numbering discrepancies in Oracle RAC 11g Release 2	318
Chapter 23	Performing Oracle RAC post-installation tasks	320
	Adding Oracle RAC patches or patchsets	320
	Configuring the CSSD resource	321
	Configuring the CSSD resource using the SF Oracle RAC script-based installer	322
	Configuring the CSSD resource using the SF Oracle RAC Web-based installer	324
	Configuring the CSSD resource manually	325
	Preventing automatic startup of Oracle Clusterware/Grid Infrastructure	327
	Relinking the SF Oracle RAC libraries with Oracle RAC	327
	Relinking the SF Oracle RAC libraries with Oracle RAC using the SF Oracle RAC script-based installer	328
	Relinking the SF Oracle RAC libraries with Oracle RAC using the SF Oracle RAC Web-based installer	329
	Relinking the SF Oracle RAC libraries with Oracle RAC manually	330

	Verifying whether Oracle uses Veritas libraries	331
	Creating the Oracle RAC database	331
	Adding Oracle UDP IPC private IP addresses to the Oracle initialization parameter file	332
	Configuring VCS service groups for Oracle RAC	334
	Supported types of database management	334
	Sample service group configurations	335
	Configuring VCS service groups manually for Oracle databases	339
	Managing database restart after failure	342
	Location of VCS log files	344
	Preventing automatic database startup	344
	Removing permissions for communication	345
	Configuring the Storage Foundation for Databases repository database after installation	345
Chapter 24	Upgrading Oracle RAC	346
	Supported upgrade paths	346
	Preparing to upgrade Oracle RAC	347
	Preparing to upgrade from Oracle RAC 10g or Oracle RAC 11g	347
	Preparing to upgrade from Oracle RAC 9i	348
	Upgrading Oracle RAC binaries	349
	Migrating the Oracle RAC database	350
	Performing post-upgrade tasks	350
Section 9	Automated installation using response files	352
Chapter 25	About response files	353
	About response files	353
	Modular deployments using response files	354
	Response file syntax	355
	Guidelines for creating the SF Oracle RAC response file	356
	Installation scenarios for response files	361

Chapter 26	Installing and configuring SF Oracle RAC using a response file	362
	Installing and configuring SF Oracle RAC	362
	Response file variables to install Veritas Storage Foundation for Oracle RAC	364
	Response file variables to configure Veritas Storage Foundation for Oracle RAC	366
	Sample response file for installing SF Oracle RAC	376
	Sample response file for configuring SF Oracle RAC	376
Chapter 27	Performing an automated I/O fencing configuration using response files	378
	Configuring I/O fencing using response files	378
	Response file variables to configure disk-based I/O fencing	379
	Sample response file for configuring disk-based I/O fencing	382
	Configuring CP server using response files	383
	Response file variables to configure CP server	383
	Sample response file for configuring the CP server on SFHA cluster	385
	Response file variables to configure server-based I/O fencing	386
	Sample response file for configuring server-based I/O fencing	387
Chapter 28	Installing Oracle RAC using a response file	389
	About installing Oracle RAC using response files	389
	Before you install	389
	Installing Oracle RAC	391
	Response file variable definitions for Oracle RAC	392
	Sample response file for installing Oracle RAC	409
Section 10	Adding and removing nodes	412
Chapter 29	Adding a node to SF Oracle RAC clusters	413
	About adding a node to a cluster	413
	Before adding a node to a cluster	414
	Adding a node to a cluster using the SF Oracle RAC installer	417
	Adding a node using the Web-based installer	421
	Adding the node to a cluster manually	422
	Starting Veritas Volume Manager (VxVM) on the new node	423
	Configuring cluster processes on the new node	423
	Setting up the node to run in secure mode	426

	Starting fencing on the new node	429
	After adding the new node	430
	Configuring server-based fencing on the new node	431
	Configuring Cluster Volume Manager (CVM) and Cluster File System (CFS) on the new node	432
	Preparing the new node for installing Oracle RAC	434
	Preparing the new nodes for installing Oracle RAC using the SF Oracle RAC script-based installer	435
	Preparing the new nodes for installing Oracle RAC using the SF Oracle RAC Web-based installer	442
	Preparing the new node manually for installing Oracle RAC	450
	Adding the new node to Oracle RAC	458
	Adding nodes to a cluster that is using authentication for SFDB tools	459
	Updating the Storage Foundation for Databases (SFDB) repository after adding a node	460
Chapter 30	Removing a node from SF Oracle RAC clusters	462
	About removing a node from a cluster	462
	Removing a node from a cluster	463
	Modifying the VCS configuration files on existing nodes	465
	Modifying the Cluster Volume Manager (CVM) configuration on the existing nodes to remove references to the deleted node	467
	Removing the node configuration from the CP server	467
	Removing security credentials from the leaving node	468
	Updating the Storage Foundation for Databases (SFDB) repository after removing a node	469
	Sample configuration file for removing a node from the cluster	469
Section 11	Configuration of disaster recovery environments	473
Chapter 31	Configuring disaster recovery environments	474
	Disaster recovery options for SF Oracle RAC	474
	About setting up a campus cluster for disaster recovery	475
	About setting up a global cluster environment for SF Oracle RAC	477
	About configuring a parallel global cluster using Veritas Volume Replicator (VVR) for replication	478

Section 12	Uninstallation of SF Oracle RAC	481
Chapter 32	Preparing to uninstall SF Oracle RAC from a cluster	482
	About uninstalling SF Oracle RAC from a cluster	482
	Options for uninstalling SF Oracle RAC	483
	Preparing to uninstall SF Oracle RAC from a cluster	484
	Stopping Oracle instances	485
	Backing up the Oracle database	486
	Unlinking the SF Oracle RAC libraries from Oracle RAC	486
	Uninstalling Oracle RAC (optional)	487
	Stopping the applications that use CVM or CFS (outside of VCS control)	487
	Unmounting CFS file systems (outside of VCS control)	488
	Stopping VCS	488
	Stopping the applications that use VxVM or VxFS (outside of VCS control)	489
	Unmounting VxFS file systems (outside of VCS control)	489
Chapter 33	Uninstalling SF Oracle RAC using the product installer	491
	Uninstalling SF Oracle RAC with the script-based installer	491
	Removing the SF Oracle RAC depots	492
	Uninstalling SF Oracle RAC with the Veritas Web-based installer	493
	Removing other configuration files (optional)	494
	Removing the Storage Foundation for Databases (SFDB) repository after removing the product	495
Chapter 34	Performing an automated uninstallation of SF Oracle RAC using response files	497
	Uninstalling SF Oracle RAC using a response file	497
	Response file variables to uninstall Veritas Storage Foundation for Oracle RAC	498
	Sample response file for uninstalling SF Oracle RAC	499

Section 13	Installation reference	501
Appendix A	Installation scripts	502
	Installation script options	502
	About using the postcheck option	507
Appendix B	Tunable files for installation	510
	About setting tunable parameters using the installer or a response file	510
	Setting tunables for an installation, configuration, or upgrade	511
	Setting tunables with no other installer-related operations	512
	Setting tunables with an un-integrated response file	513
	Preparing the tunables file	514
	Setting parameters for the tunables file	514
	Tunables value parameter definitions	515
Appendix C	Sample installation and configuration values	522
	About the installation and configuration worksheets	522
	SF Oracle RAC worksheet	523
	Veritas Cluster Server component information	526
	I/O fencing information	527
	Cluster Volume Manager information	528
	SF Oracle RAC add user information	528
	Global cluster information	529
	Veritas Volume Replicator information	530
	Oracle RAC worksheet	530
	Replicated cluster using VVR worksheet	543
	Replicated cluster using SRDF worksheet	544
	Required installation information for Oracle Clusterware/Grid Infrastructure	546
	Required installation information for Oracle database	550
Appendix D	Sample configuration files	552
	About VCS configuration file	552
	About the LLT and GAB configuration files	553
	About I/O fencing configuration files	555
	Sample configuration files	557
	sfrac01_main.cf file	558
	sfrac02_main.cf file	559
	sfrac03_main.cf file	560

	sfrac04_main.cf file	561
	sfrac05_main.cf file	563
	sfrac06_main.cf file	564
	sfrac07_main.cf and sfrac08_main.cf files	565
	sfrac09_main.cf and sfrac10_main.cf files	567
	sfrac11_main.cf file	570
	sfrac12_main.cf and sfrac13_main.cf files	571
	sfrac14_main.cf file	574
	Sample configuration files for CP server	575
Appendix E	Setting up inter-system communication	582
	About using ssh or remsh with the Veritas installer	582
	Setting up inter-system communication	583
	Setting up ssh on cluster systems	583
Appendix F	Automatic Storage Management	585
	About ASM in SF Oracle RAC environments	585
	ASM configuration with SF Oracle RAC	586
	Configuring ASM in SF Oracle RAC environments	588
	Setting up Automatic Storage Management	589
	Unlinking the SF Oracle RAC ODM library	591
	Creating database storage on ASM	592
	Creating ASM disk groups and instances	593
	Verifying the ASM setup	594
	Configuring VCS service groups for database instances on ASM	594
	Sample configuration file Veritas CVM and ASM main.cf file	597
Appendix G	Creating a test database	598
	About creating a test database	598
	Creating a database for Oracle	598
	Creating the database storage on raw volumes	599
	Creating the database storage on CFS	600
Appendix H	High availability agent information	602
	About agents	602
	VCS agents included within SF Oracle RAC	603
	VCS agents for Oracle included within SF Oracle RAC	603
	CVMCluster agent	604
	Entry points for CVMCluster agent	604
	Attribute definition for CVMCluster agent	605

CVMCluster agent type definition	606
CVMCluster agent sample configuration	606
CVMVxconfigd agent	606
Entry points for CVMVxconfigd agent	607
Attribute definition for CVMVxconfigd agent	607
CVMVxconfigd agent type definition	609
CVMVxconfigd agent sample configuration	609
CVMVoidg agent	609
Entry points for CVMVoidg agent	609
Attribute definition for CVMVoidg agent	610
CVMVoidg agent type definition	611
CVMVoidg agent sample configuration	612
CFSMount agent	612
Entry points for CFSMount agent	613
Attribute definition for CFSMount agent	613
CFSMount agent type definition	615
CFSMount agent sample configuration	616
CFSfsckd agent	616
Entry points for CFSfsckd agent	616
Attribute definition for CFSfsckd agent	617
CFSfsckd agent type definition	618
CFSfsckd agent sample configuration	619
PrivNIC agent	619
Functions of the PrivNIC agent	620
Attributes of the PrivNIC agent	620
States of the PrivNIC agent	623
Sample service group configuration with the PrivNIC agent	623
Type definition of the PrivNIC resource	624
Sample configuration of the PrivNIC resource	625
MultiPrivNIC agent	625
Managing high availability of private interconnects	626
Functions of the MultiPrivNIC agent	626
Attributes of the MultiPrivNIC agent	627
States of the MultiPrivNIC agent	629
Sample service group configuration with the MultiPrivNIC agent	630
Type definition of the MultiPrivNIC resource	630
Sample configuration of the MultiPrivNIC resource	631
CSSD agent	631
Functions of the CSSD agent	632
Attributes of the CSSD agent	632
States of the CSSD agent	633
Sample service group configurations with the CSSD agent	633

Type definition of the CSSD resource	634
Sample configuration of the CSSD resource	634
VCS agents for Oracle	635
Oracle agent functions	635
Resource type definition for the Oracle agent	641
Netlsnr agent functions	649
Resource type definition for the Netlsnr agent	650
ASMDG agent functions	654
Resource type definition for the ASMDG agent	655
CRSResource agent	657
Functions of the CRSResource agent	657
States of the CRSResource agent	658
Attributes of the CRSResource agent	658
VCS service group dependencies with the CRSResource agent	659
Resource type definition for the CRSResource agent	664
Sample configuration for the CRSResource agent	664
Appendix I SF Oracle RAC deployment scenarios	666
SF Oracle RAC cluster with VCS IPC and PrivNIC agent	666
SF Oracle RAC cluster with UDP IPC and PrivNIC agent	669
SF Oracle RAC cluster for multiple databases with UDP IPC and MultiPrivNIC agent	670
SF Oracle RAC cluster with isolated Oracle traffic and MultiPrivNIC agent	673
SF Oracle RAC cluster with NIC bonding, VCS IPC and PrivNIC agent	675
SF Oracle RAC cluster with NIC bonding, UDP IPC, and PrivNIC agent	677
Configuration diagrams for setting up server-based I/O fencing	679
Two unique client clusters served by 3 CP servers	679
Client cluster served by highly available CPS and 2 SCSI-3 disks	680
Two node campus cluster served by remote CP server and 2 SCSI-3 disks	682
Multiple client clusters served by highly available CP server and 2 SCSI-3 disks	684
Deploying Storage Foundation for Databases (SFDB) tools in a Storage Foundation for Oracle RAC environment	686

Appendix J	Compatibility issues when installing Veritas Storage Foundation for Oracle RAC with other products	688
	Installing, uninstalling, or upgrading Storage Foundation products when other Veritas products are present	688
	Installing, uninstalling, or upgrading Storage Foundation products when VOM is already present	689
	Installing, uninstalling, or upgrading Storage Foundation products when NetBackup is already present	689
Glossary		690
Index		694

Installation overview and planning

- [Chapter 1. Introducing Veritas Storage Foundation for Oracle RAC](#)
- [Chapter 2. System requirements](#)
- [Chapter 3. Planning to install SF Oracle RAC](#)
- [Chapter 4. Licensing SF Oracle RAC](#)

Introducing Veritas Storage Foundation for Oracle RAC

This chapter includes the following topics:

- [About Veritas Storage Foundation for Oracle RAC](#)
- [About SF Oracle RAC components](#)
- [About SF Oracle RAC optional features](#)
- [About Cluster Manager \(Java Console\)](#)
- [About Veritas Operations Manager](#)
- [About Symantec Operations Readiness Tools](#)
- [SF Oracle RAC cluster setup models](#)

About Veritas Storage Foundation for Oracle RAC

Veritas Storage Foundation™ for Oracle® RAC (SF Oracle RAC) leverages proprietary storage management and high availability technologies to enable robust, manageable, and scalable deployment of Oracle RAC on UNIX platforms. The solution uses Veritas Cluster File System technology that provides the dual advantage of easy file system management as well as the use of familiar operating system tools and utilities in managing databases.

The solution stack comprises the Veritas Cluster Server (VCS), Veritas Cluster Volume Manager (CVM), Veritas Oracle Real Application Cluster Support (VRTSdbac), Veritas Oracle Disk Manager (VRTSodm), Veritas Cluster File System (CFS), and Veritas Storage Foundation, which includes the base Veritas Volume Manager (VxVM) and Veritas File System (VxFS).

Benefits of SF Oracle RAC

SF Oracle RAC provides the following benefits:

- Support for file system-based management. SF Oracle RAC provides a generic clustered file system technology for storing and managing Oracle data files as well as other application data.
- Support for high-availability of cluster interconnects.
For Oracle RAC 10g Release 2:
The combination of LMX/LLT protocols and the PrivNIC/MultiPrivNIC agents provides maximum bandwidth as well as high availability of the cluster interconnects, including switch redundancy.
For Oracle RAC 11g Release 1/Oracle RAC 11g Release 2:
The PrivNIC/MultiPrivNIC agents provide maximum bandwidth as well as high availability of the cluster interconnects, including switch redundancy.
See the following Technote regarding co-existence of PrivNIC/MultiPrivNIC agents with Oracle RAC 11.2.0.2 and later versions:
<http://www.symantec.com/business/support/index?page=content&id=TECH145261>
- Use of Cluster File System and Cluster Volume Manager for placement of Oracle Cluster Registry (OCR) and voting disks. These technologies provide robust shared block interfaces (for all supported Oracle RAC versions) and raw interfaces (for Oracle RAC 10g Release 2) for placement of OCR and voting disks.
- Support for a standardized approach toward application and database management. Administrators can apply their expertise of Veritas technologies toward administering SF Oracle RAC.
- Increased availability and performance using Veritas Dynamic Multi-Pathing (DMP). DMP provides wide storage array support for protection from failures and performance bottlenecks in the Host Bus Adapters (HBA), Storage Area Network (SAN) switches, and storage arrays.
- Easy administration and monitoring of multiple SF Oracle RAC clusters using Veritas Operations Manager.
- VCS OEM plug-in provides a way to monitor SF Oracle RAC resources from the OEM console.
- Improved file system access times using Oracle Disk Manager (ODM).
- Ability to configure Oracle Automatic Storage Management (ASM) disk groups over CVM volumes to take advantage of Veritas Dynamic Multi-Pathing (DMP).
- Enhanced scalability and availability with access to multiple Oracle RAC instances per database in a cluster.

- Support for backup and recovery solutions using volume-level and file system-level snapshot technologies, Storage Checkpoints, and Database Storage Checkpoints.
- Support for space optimization using periodic deduplication in a file system to eliminate duplicate data without any continuous cost.
For more information, see the Veritas Storage Foundation Administrator's documentation.
- Ability to fail over applications with minimum downtime using Veritas Cluster Server (VCS) and Veritas Cluster File System (CFS).
- Prevention of data corruption in split-brain scenarios with robust SCSI-3 Persistent Group Reservation (PGR) based I/O fencing or Coordination Point Server-based I/O fencing. The preferred fencing feature also enables you to specify how the fencing driver determines the surviving subcluster.
- Support for sharing application data, in addition to Oracle database files, across nodes.
- Support for policy-managed databases in Oracle RAC 11g Release 2.
- Fast disaster recovery with minimal downtime and interruption to users. Users can transition from a local high availability site to a wide-area disaster recovery environment with primary and secondary sites. If a site fails, clients that are attached to the failed site can reconnect to a surviving site and resume access to the shared database.
- Verification of disaster recovery configuration using fire drill technology without affecting production systems.
- Support for a wide range of hardware replication technologies as well as block-level replication using VVR.
- Support for campus clusters with the following capabilities:
 - Consistent detach with Site Awareness
 - Site aware reads with VxVM mirroring
 - Monitoring of Oracle resources
 - Protection against split-brain scenarios

About SF Oracle RAC components

[Table 1-1](#) lists the components of SF Oracle RAC.

Table 1-1 SF Oracle RAC components

Component	Description
Cluster Volume Manager	Cluster Volume Manager (CVM) enables simultaneous access to the shared volumes that are based on technology from Veritas Volume Manager (VxVM).
Cluster File System	Cluster File System (CFS) enables simultaneous access to the shared file systems that are based on technology from Veritas File System (VxFS).
Veritas Cluster Server	Veritas Cluster Server (VCS) manages Oracle RAC databases and infrastructure components in a clustered environment.
Veritas I/O fencing	Veritas I/O fencing protects the data on shared disks using SCSI-3 Persistent Group Reservations when nodes in a cluster detect a change in the network cluster membership with a potential split brain condition.
Oracle Disk Manager	Oracle Disk Manager (ODM) is a disk and file management interface that is provided by Oracle to improve disk I/O performance. ODM enables Oracle to allocate and release disk space, manage tablespaces, and read/write disk blocks directly. SF Oracle RAC uses a custom driver that enables applications to use ODM for enhanced file system performance and easy file administration.
RAC Extensions	RAC Extensions manage the cluster membership and communications between cluster nodes.

For a detailed understanding of each component and the architectural overview, see the *Veritas Storage Foundation for Oracle RAC Administrator's Guide*.

About SF Oracle RAC optional features

You can configure the following optional features in an SF Oracle RAC cluster:

- VCS notifications
 See [“About VCS notifications”](#) on page 29.
- Campus clusters
 See [“About campus clusters”](#) on page 29.
- Global clusters
 See [“About global clusters”](#) on page 29.

- Storage Foundation Database Management tools
See “[About database management using SF Oracle RAC](#)” on page 30.
- Veritas Volume Replicator
See “[About Veritas Volume Replicator](#)” on page 30.

Note: I/O fencing is mandatory in SF Oracle RAC installations. All other features are optional and may be configured to suit your business needs.

About VCS notifications

You can configure both Simple Network Management Protocol (SNMP) and Simple Mail Transfer Protocol (SMTP) notifications for VCS. Symantec recommends you to configure at least one of these notifications. You have the following options:

- Configure SNMP trap notification of VCS events using the VCS Notifier component.
- Configure SMTP email notification of VCS events using the VCS Notifier component.

See the *Veritas Cluster Server Administrator's Guide*.

About campus clusters

A campus cluster has alternate nodes located in different data centers. Campus clusters are connected using a high speed cable that guarantees network access between the nodes. The campus cluster configuration provides local high availability and disaster recovery functionality in a single SF Oracle RAC cluster. This configuration uses data mirroring to duplicate data at different sites.

SF Oracle RAC supports campus clusters that employ shared disk groups mirrored across sites with Veritas Volume Manager (VxVM).

About global clusters

Global clusters provide the ability to fail over applications between geographically distributed clusters when disaster occurs. This type of clustering involves migrating applications between clusters over a considerable distance. You can set up HA/DR using hardware-based or software-based replication technologies.

About Veritas Volume Replicator

Veritas Volume Replicator (VVR) is a software-based replication technology used in global cluster disaster recovery setups that replicates data to remote sites over any standard IP network. You can have up to 32 remote sites.

About database management using SF Oracle RAC

You can leverage the database management capabilities of the Storage Foundation for Databases (SFDB) tools to simplify storage management and improve database performance.

For information on supported capabilities, see the *Veritas Storage Foundation: Storage and Availability Management for Oracle Databases* guide.

About Cluster Manager (Java Console)

Cluster Manager (Java Console) offers administration capabilities for your cluster. Use the different views in the Java Console to monitor and manage clusters and Veritas Cluster Server (VCS) objects, including service groups, systems, resources, and resource types. You cannot manage the new features of releases 6.0 and later using the Java Console.

See *Veritas Cluster Server Administrator's Guide*.

If you want to manage a single cluster using Cluster Manager (Java Console), the latest version is available for download from <https://sort.symantec.com/vom>. You will need a (free) SymAccount for downloading.

The Veritas Cluster Server Management Console is deprecated. Symantec recommends using Veritas Operations Manager to manage Storage Foundation and Cluster Server environments.

About Veritas Operations Manager

Veritas Operations Manager provides a centralized management console for Veritas Storage Foundation and High Availability products. You can use Veritas Operations Manager to monitor, visualize, and manage storage resources and generate reports.

Symantec recommends using Veritas Operations Manager (VOM) to manage Storage Foundation and Cluster Server environments.

You can download Veritas Operations Manager at no charge at <http://go.symantec.com/vom>.

Refer to the Veritas Operations Manager documentation for installation, upgrade, and configuration instructions.

The Veritas Enterprise Administrator (VEA) console is no longer packaged with Storage Foundation products. If you want to continue using VEA, a software version is available for download from <http://www.symantec.com/operations-manager/support>. Veritas Storage Foundation Management Server is deprecated.

If you want to manage a single cluster using Cluster Manager (Java Console), a version is available for download from https://www4.symantec.com/Vrt/offer?a_id=89446. You cannot manage the new features of this release using the Java Console. Veritas Cluster Server Management Console is deprecated.

About Symantec Operations Readiness Tools

Symantec Operations Readiness Tools (SORT) is a Web site that automates and simplifies some of the most time-consuming administrative tasks. SORT helps you manage your datacenter more efficiently and get the most out of your Symantec products.

Among its broad set of features, SORT lets you do the following:

- Generate server-specific reports that describe how to prepare your servers for installation or upgrade of Symantec enterprise products.
- Access a single site with the latest production information, including patches, agents, and documentation.
- Create automatic email notifications for changes in patches, documentation, and array-specific modules.

To access SORT, go to:

<https://sort.symantec.com>

SF Oracle RAC cluster setup models

SF Oracle RAC supports a variety of cluster configurations.

Depending on your business needs, you may choose from the following setup models:

- Basic setup
See [“Typical configuration of four-node SF Oracle RAC cluster”](#) on page 32.
- Secure setup

See [“Typical configuration of SF Oracle RAC clusters in secure mode”](#) on page 34.

- Central management setup
See [“Typical configuration of VOM-managed SF Oracle RAC clusters”](#) on page 35.
- Campus cluster setup
See [“Typical configuration of SF Oracle RAC campus clusters for disaster recovery”](#) on page 35.
- Global cluster setup
See [“Typical configuration of SF Oracle RAC global clusters for disaster recovery”](#) on page 38.

Typical configuration of four-node SF Oracle RAC cluster

[Figure 1-1](#) depicts a high-level view of a basic SF Oracle RAC configuration for a four-node cluster.

Figure 1-1 Sample four-node SF Oracle RAC cluster

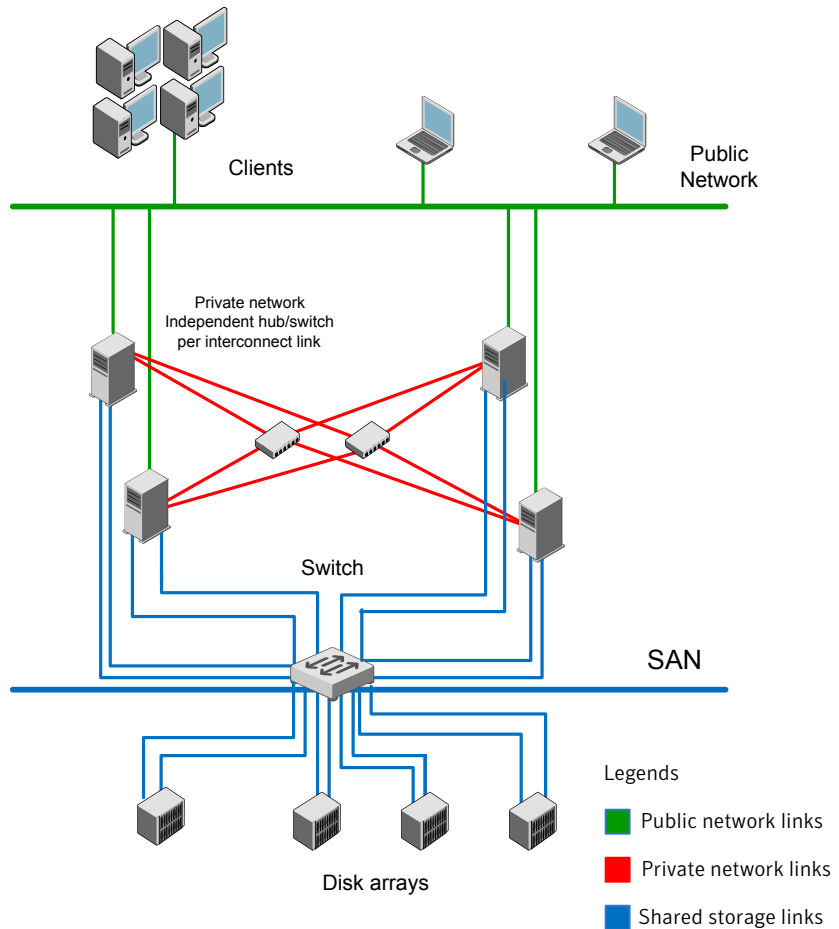

A basic topology has the following layout and characteristics:

- Multiple client applications that access nodes in the cluster over a public network.
- Nodes that are connected by at least two private network links (also called cluster interconnects) using 100BaseT or gigabit Ethernet controllers on each system, using similar network devices.
 If the private links are on a single switch, isolate them using VLAN.
- Nodes that are connected to iSCSI or Fibre Channel shared storage devices over SAN.
 All shared storage must support SCSI-3 PR.

- The Oracle Cluster Registry and vote disks configured on the shared storage that is available to each node.
 For Oracle RAC 10g Release 2: The shared storage for Oracle Cluster Registry and vote disks can be a cluster file system or raw VxVM volumes.
 For Oracle RAC 11g Release 2: The shared storage for Oracle Cluster Registry and vote disks can be a cluster file system or ASM disk groups created using raw VxVM volumes.
- Three or more odd number of disks or LUNs used as coordinator disks for I/O fencing.
- VCS manages the resources that are required by Oracle RAC. The resources must run in parallel on each node.

Typical configuration of SF Oracle RAC clusters in secure mode

Enabling secure mode for SF Oracle RAC guarantees that all inter-system communication is encrypted and that security credentials of users are verified.

Figure 1-2 illustrates typical configuration of SF Oracle RAC clusters in secure mode.

Figure 1-2 Typical configuration of SF Oracle RAC clusters in secure mode

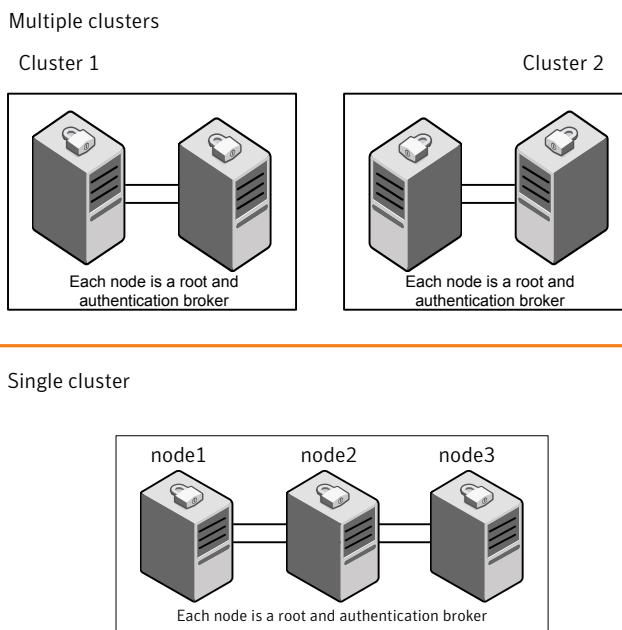

Typical configuration of VOM-managed SF Oracle RAC clusters

Veritas Operations Manager (VOM) provides a centralized management console for Veritas Storage Foundation and High Availability products.

See [“About Veritas Operations Manager”](#) on page 30.

Figure 1-3 illustrates a typical setup of SF Oracle RAC clusters that are centrally managed using Veritas Operations Manager.

Figure 1-3 Typical configuration of VOM-managed clusters

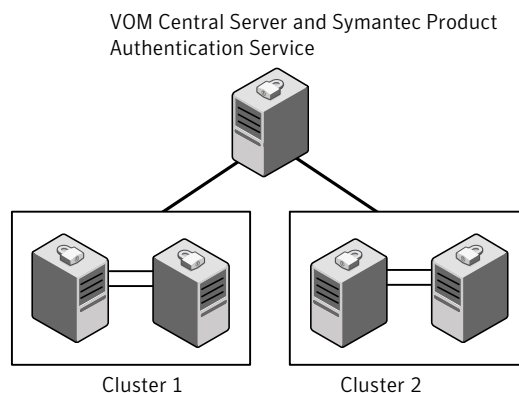

Typical configuration of SF Oracle RAC campus clusters for disaster recovery

A campus cluster configuration provides local high availability and disaster recovery capability in a single SF Oracle RAC cluster. This configuration uses data mirroring to duplicate data at different sites. No host or array replication is involved in the process. SF Oracle RAC supports campus clusters that employ shared disk groups mirrored with Cluster Volume Manager (CVM).

The SF Oracle RAC campus cluster addresses the following basic challenges in campus cluster configurations:

Latency challenges

An SF Oracle RAC campus cluster handles latency challenges in keeping mirrors synchronized while ensuring the efficient recovery in case of site failures for both data and VxVM metadata.

Read performance

The read performance is enhanced as data is read from local mirrors.

Site awareness

SF Oracle RAC makes sure that all the mirrors on a site are detached proactively even when a part of the site goes down.

Note: The DiskGroupSnap agent is not supported for SF Oracle RAC.

[Figure 1-4](#) illustrates a basic campus cluster setup.

Figure 1-4 Basic campus cluster setup

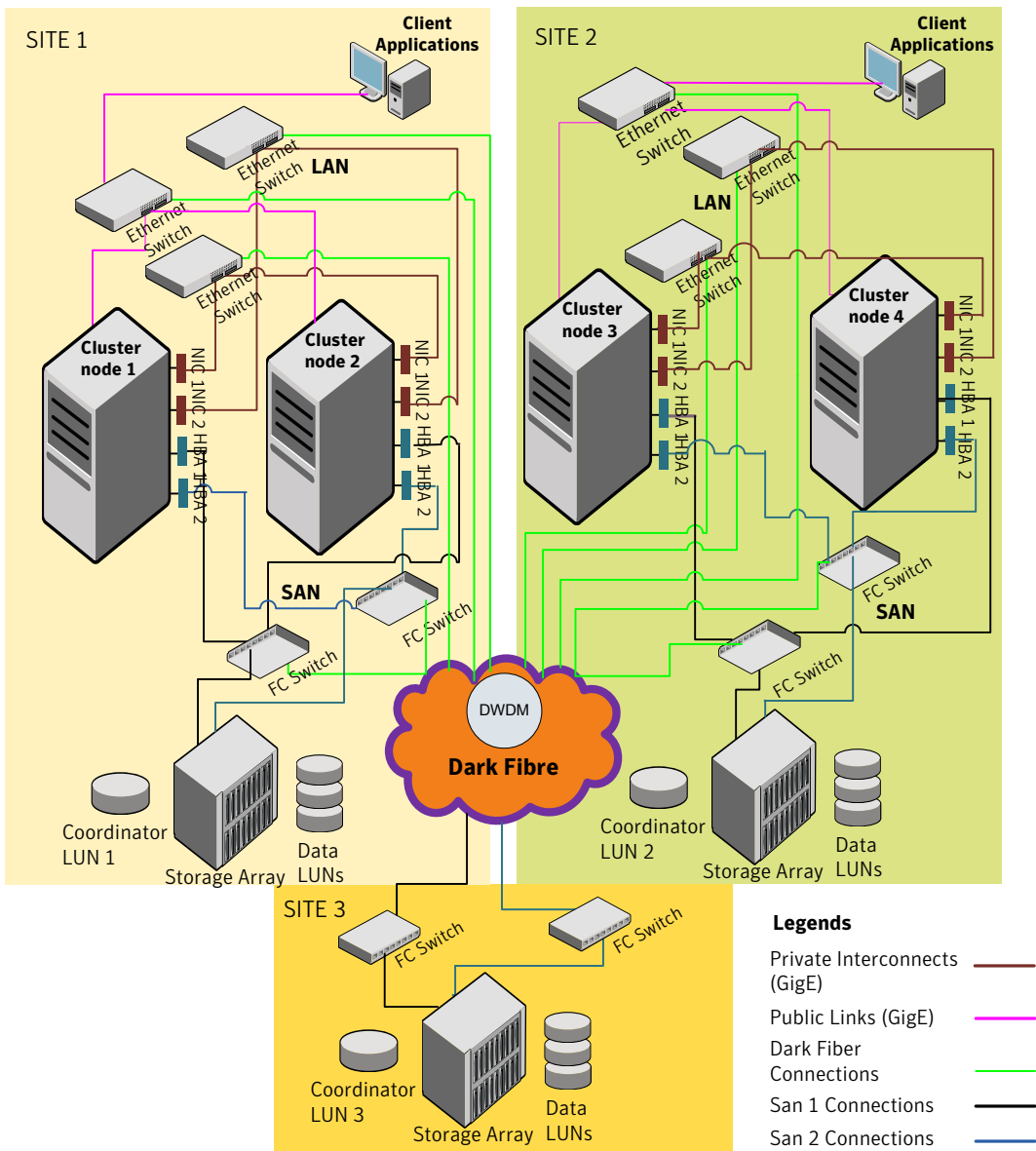

For more information, see the chapter *Configuring a campus cluster setup for disaster recovery*.

Typical configuration of SF Oracle RAC global clusters for disaster recovery

SF Oracle RAC leverages the global clustering feature of VCS to enable high availability and disaster recovery (HA/DR) for businesses that span wide geographical areas. Global clusters provide protection against outages caused by large-scale disasters such as major floods, hurricanes, and earthquakes. An entire cluster can be affected by such disasters. This type of clustering involves migrating applications between clusters over a considerable distance.

You can set up HA/DR using hardware-based or software-based replication technologies.

Figure 1-5 Global clusters

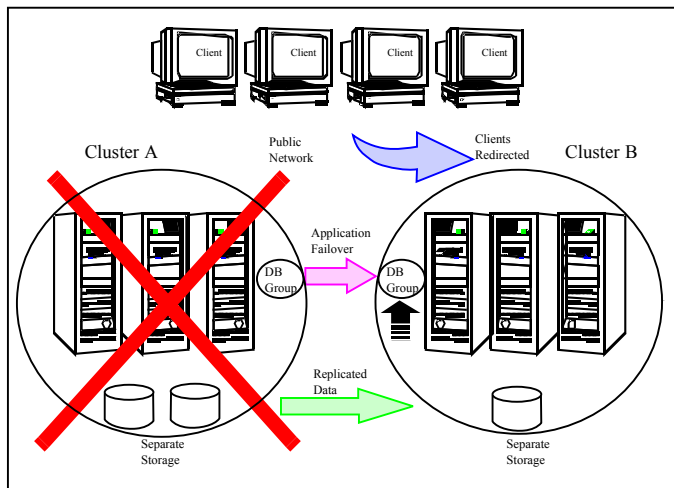

To understand how global clusters work, review the example of an Oracle RAC database configured using global clustering. Oracle RAC is installed and configured in cluster A and cluster B. Oracle database is located on shared disks within each cluster and is replicated across clusters to ensure data concurrency. The VCS service groups for Oracle are online on a node in cluster A and are configured to fail over on cluster A and cluster B.

VCS continuously monitors and communicates events between clusters. If cluster A fails, the Oracle database is started on the remote cluster B.

Note: You must have an SF Oracle RAC HA/DR license to configure global clusters. If you use VVR for replication, you must also have a VVR license. You may configure a basic cluster initially and add the HA/DR and VVR licenses at a later time or you may add the licenses during the SF Oracle RAC installation.

For information on supported replication technologies:

See [“Supported replication technologies for global clusters”](#) on page 47.

System requirements

This chapter includes the following topics:

- [Important preinstallation information](#)
- [Hardware requirements](#)
- [Supported operating systems](#)
- [I/O fencing requirements](#)
- [Supported database software](#)
- [Supported replication technologies for global clusters](#)
- [Discovering product versions and various requirement information](#)

Important preinstallation information

Before you install SF Oracle RAC, make sure you have reviewed the following information:

- Hardware compatibility list for information about supported hardware:
<http://www.symantec.com/docs/TECH170013>
- Latest information on support for Oracle database versions:
<http://www.symantec.com/docs/DOC5081>
- General information regarding the release, installation notes, known issues, and fixed issues:
See *Veritas Storage Foundation for Oracle RAC Release Notes*.
- Oracle documentation for additional requirements pertaining to your version of Oracle.

Hardware requirements

Depending on the type of setup planned, make sure you meet the necessary hardware requirements.

For basic clusters See [Table 2-1](#) on page 41.

For campus clusters See [Table 2-2](#) on page 42.

Table 2-1 Hardware requirements for basic clusters

Item	Description
SF Oracle RAC systems	Two to sixteen systems with two or more CPUs. For details on the additional requirements for Oracle, see the Oracle documentation.
DVD drive	A DVD drive on one of the nodes in the cluster.
Disks	SF Oracle RAC requires that all shared storage disks support SCSI-3 Persistent Reservations (PR). Note: The coordinator disk does not store data, so configure the disk as the smallest possible LUN on a disk array to avoid wasting space. The minimum size required for a coordinator disk is 128 MB.
Disk space	You can evaluate your systems for available disk space by running the product installation program. Navigate to the product directory on the product disc and run the following command: <pre># ./installsf rac -precheck node_name</pre> You can also use the Veritas Web-based installation program to determine the available disk space. For details on the additional space that is required for Oracle, see the Oracle documentation.
RAM	Each SF Oracle RAC system requires at least 2 GB. For Oracle RAC requirements, see the Oracle Metalink document: 169706.1
Swap space	See the Oracle Metalink document: 169706.1

Table 2-1 Hardware requirements for basic clusters (*continued*)

Item	Description
Network	<p>Two or more private links and one public link.</p> <p>Links must be 100BaseT or gigabit Ethernet directly linking each node to the other node to form a private network that handles direct inter-system communication. These links must be of the same type; you cannot mix 100BaseT and gigabit.</p> <p>Symantec recommends gigabit Ethernet using enterprise-class switches for the private links.</p> <p>Oracle requires that all nodes use the IP addresses from the same subnet.</p> <p>You can also configure aggregated interfaces.</p>
Fiber Channel or SCSI host bus adapters	At least one additional SCSI or Fibre Channel Host Bus Adapter per system for shared data disks.

Table 2-2 lists the hardware requirements for campus clusters in addition to the basic cluster requirements.

Table 2-2 Hardware requirements for campus clusters

Item	Description
Storage	<ul style="list-style-type: none"> ■ The storage switch (to which each host on a site connects) must have access to storage arrays at all the sites. ■ Volumes must be mirrored with storage allocated from at least two sites. ■ DWDM links are recommended between sites for storage links. DWDM works at the physical layer and requires multiplexer and de-multiplexer devices. ■ The storage and networks must have redundant-loop access between each node and each storage array to prevent the links from becoming a single point of failure.
Network	<ul style="list-style-type: none"> ■ Oracle requires that all nodes use the IP addresses from the same subnet. ■ Symantec recommends a common cross-site physical infrastructure for storage and LLT private networks.
I/O fencing	I/O fencing requires placement of a third coordinator point at a third site. The DWDM can be extended to the third site or the iSCSI LUN at the third site can be used as the third coordination point. Alternatively Coordination Point Server can be deployed at the third remote site as an arbitration point.

Supported operating systems

For information on supported operating systems, see the *Veritas Storage Foundation for Oracle RAC Release Notes*.

I/O fencing requirements

Depending on whether you plan to configure disk-based fencing or server-based fencing, make sure that you meet the requirements for coordination points:

- Coordinator disks
See [“Coordinator disk requirements for I/O fencing”](#) on page 43.
- CP servers
See [“CP server requirements”](#) on page 43.

Note: Irrespective of whether you use coordinator disks or CP server for I/O fencing, ensure that the shared storage supports SCSI-3 persistent reservations.

Coordinator disk requirements for I/O fencing

Make sure that the I/O fencing coordinator disks meet the following requirements:

- For disk-based I/O fencing, you must have at least three coordinator disks or there must be odd number of coordinator disks.
- The coordinator disks can be DMP devices or iSCSI devices.
- Each of the coordinator disks must use a physically separate disk or LUN. Symantec recommends using the smallest possible LUNs for coordinator disks.
- Each of the coordinator disks should exist on a different disk array, if possible.
- The coordinator disks must support SCSI-3 persistent reservations.
- Symantec recommends using hardware-based mirroring for coordinator disks.
- Coordinator disks must not be used to store data or must not be included in disk groups that store user data.
- Coordinator disks cannot be the special devices that array vendors use. For example, you cannot use EMC gatekeeper devices as coordinator disks.

CP server requirements

SF Oracle RAC 6.0.1 clusters (application clusters) support coordination point servers (CP servers) which are hosted on the following VCS and SFHA versions:

- VCS 6.0.1, VCS 6.0, VCS 6.0 PR1, VCS 6.0 RP1, VCS 5.1SP1, or VCS 5.1 single-node cluster
Single-node VCS clusters with VCS 5.1 SP1 RP1 and later or VCS 6.0 and later that hosts CP server does not require LLT and GAB to be configured.
- SFHA 6.0.1, SFHA 6.0, SFHA 6.0 PR1, SFHA 6.0 RP1, 5.1SP1, or 5.1 cluster

Warning: Before you upgrade 5.1 CP server nodes to use VCS or SFHA 6.0.1, you must upgrade all the application clusters that use this CP server to version 6.0.1. Application clusters at version 5.1 cannot communicate with CP server that runs VCS or SFHA 5.1 SP1 or later.

Make sure that you meet the basic hardware requirements for the VCS/SFHA cluster to host the CP server.

See the *Veritas Cluster Server Installation Guide* or the *Veritas Storage Foundation High Availability Installation Guide*.

Note: SF Oracle RAC requires at least 3 coordination points for I/O fencing.

Make sure you meet the following additional CP server requirements which are covered in this section before you install and configure CP server:

- Hardware requirements
- Operating system requirements
- Networking requirements (and recommendations)
- Security requirements

[Table 2-3](#) lists additional requirements for hosting the CP server.

Table 2-3 CP server hardware requirements

Hardware required	Description
Disk space	<p>To host the CP server on a VCS cluster or SFHA cluster, each host requires the following file system space:</p> <ul style="list-style-type: none"> ■ 550 MB in the /opt directory (additionally, the language pack requires another 15 MB) ■ 300 MB in /usr ■ 20 MB in /var ■ 10 MB in /etc (for the CP server database)

Table 2-3 CP server hardware requirements (*continued*)

Hardware required	Description
Storage	When CP server is hosted on an SFHA cluster, there must be shared storage between the nodes of this SFHA cluster.
RAM	Each CP server requires at least 512 MB.
Network	Network hardware capable of providing TCP/IP connection between CP servers and SF Oracle RAC clusters (application clusters).

[Table 2-4](#) displays the CP server supported operating systems and versions. An application cluster can use a CP server that runs any of the following supported operating systems.

Table 2-4 CP server supported operating systems and versions

CP server	Operating system and version
CP server hosted on a VCS single-node cluster or on an SFHA cluster	<p>CP server supports any of the following operating systems:</p> <ul style="list-style-type: none"> ■ AIX 6.1 and 7.1 ■ HP-UX 11i v3 ■ Linux: <ul style="list-style-type: none"> ■ RHEL 5 ■ RHEL 6 ■ SLES 10 ■ SLES 11 ■ Oracle Solaris 10 ■ Oracle Solaris 11 <p>Review other details such as supported operating system levels and architecture for the supported operating systems.</p> <p>See the <i>Veritas Cluster Server Release Notes</i> or the <i>Veritas Storage Foundation High Availability Release Notes</i> for that platform.</p>

Following are the CP server networking requirements and recommendations:

- Symantec recommends that network access from the application clusters to the CP servers should be made highly-available and redundant. The network connections require either a secure LAN or VPN.
- The CP server uses the TCP/IP protocol to connect to and communicate with the application clusters by these network paths. The CP server listens for

messages from the application clusters using TCP port 14250. This is the default port that can be changed during a CP server configuration.

Symantec recommends that you configure multiple network paths to access a CP server. If a network path fails, CP server does not require a restart and continues to listen on all the other available virtual IP addresses.

- The CP server supports Internet Protocol version 4 (IPv4 addresses) when communicating with the application clusters.
- When placing the CP servers within a specific network configuration, you must take into consideration the number of hops from the different application cluster nodes to the CP servers. As a best practice, Symantec recommends that the number of hops and network latency from the different application cluster nodes to the CP servers should be equal. This ensures that if an event occurs that results in an I/O fencing scenario, there is no bias in the race due to difference in number of hops or network latency between the CPS and various nodes.

For secure communication between the SF Oracle RAC cluster (application cluster) and the CP server, review the following support matrix:

Communication mode	CP server in secure mode	CP server in non-secure mode
SF Oracle RAC cluster in secure mode	Yes	Yes
SF Oracle RAC cluster in non-secure mode	Yes	Yes

For secure communications between the SF Oracle RAC and CP server, consider the following requirements and suggestions:

- In a secure communication environment, all CP servers that are used by the application cluster must be configured with security enabled. A configuration where the application cluster uses some CP servers running with security enabled and other CP servers running with security disabled is not supported.
- For non-secure communication between CP server and application clusters, there is no need to configure Symantec Product Authentication Service. In non-secure mode, authorization is still provided by CP server for the application cluster users. The authorization that is performed only ensures that authorized users can perform appropriate actions as per their user privileges on the CP server.

For information about establishing secure communications between the application cluster and CP server, see the *Veritas Storage Foundation for Oracle RAC Administrator's Guide*.

Supported database software

Note: SF Oracle RAC supports only 64-bit Oracle.

The following database versions are supported:

- Oracle RAC 10g Release 2
- Oracle RAC 11g Release 1 Database

Note: Oracle RAC 11g Release 1 Clusterware is not supported. You need to install Oracle RAC 11g Release 2 Clusterware to use Oracle RAC 11g Release 1 database.

- Oracle RAC 11g Release 2

For the latest information on supported Oracle database versions, see the following Technical Support TechNote:

<http://www.symantec.com/docs/DOC5081>

Support for minor database versions is also documented in the afore-mentioned Technical Support TechNote.

Additionally, see the following Oracle support site for information on patches that may be required by Oracle for each release.

<https://support.oracle.com>

Supported replication technologies for global clusters

SF Oracle RAC supports the following hardware-based replication and software-based replication technologies for global cluster configurations:

- | | |
|----------------------------|---|
| Hardware-based replication | <ul style="list-style-type: none">■ EMC SRDF■ Hitachi TrueCopy■ IBM Metro Mirror■ IBM SAN Volume Controller (SVC)■ EMC MirrorView |
| Software-based replication | <ul style="list-style-type: none">■ Veritas Volume Replicator■ Oracle Data Guard |

Discovering product versions and various requirement information

Symantec provides several methods to check the Veritas product you have installed, plus various requirement information.

You can check the existing product versions using the `installer` command with the `-version` option before or after you install. After you have installed the current version of the product, you can use the `showversion` script in the `/opt/VRTS/install` directory to find version information.

The information that the `version` option or the `showversion` script discovers on systems includes the following:

- The installed version of all released Storage Foundation and High Availability Suite of products
- The required depots or patches (if applicable) that are missing
- The available updates (including patches or hotfixes) from Symantec Operations Readiness Tools (SORT) for the installed products

To run the version checker

- 1 Mount the media.
- 2 Start the installer with the `-version` option.

```
# ./installer -version system1 system2
```

Planning to install SF Oracle RAC

This chapter includes the following topics:

- [Planning your network configuration](#)
- [Planning the storage](#)
- [Planning volume layout](#)
- [Planning file system design](#)
- [About planning to configure I/O fencing](#)
- [Planning for cluster management](#)

Planning your network configuration

The following practices are recommended for a resilient network setup:

- Configure the private cluster interconnect over multiple dedicated gigabit Ethernet links. All single point of failures such as network interface cards (NIC), switches, and interconnects should be eliminated.
- The NICs used for the private cluster interconnect should have the same characteristics regarding speed, MTU, and full duplex on all nodes. Do not allow the NICs and switch ports to auto-negotiate speed.
- Configure non-routable IP addresses for private cluster interconnects.
- The default value for LLT peer inactivity timeout is 16 seconds. The value should be set based on service availability requirements and the propagation delay between the cluster nodes in case of campus cluster setup. The LLT peer inactivity timeout value indicates the interval after which SF Oracle RAC on one

node declares the other node in the cluster dead, if there is no network communication (heartbeat) from that node.

The default value for the CSS miss-count in case of SF Oracle RAC is 600 seconds. The value of this parameter is much higher than the LLT peer inactivity timeout so that the two clusterwares, VCS and Oracle Clusterware, do not interfere with each other's decisions on which nodes should remain in the cluster in the event of network split-brain. Veritas I/O fencing is allowed to decide on the surviving nodes first, followed by Oracle Clusterware. The CSS miss-count value indicates the amount of time Oracle Clusterware waits before evicting another node from the cluster, when it fails to respond across the interconnect. For more information, see the Oracle Metalink document: 782148.1

Planning the public network configuration for Oracle RAC

Identify separate public virtual IP addresses for each node in the cluster. Oracle requires one public virtual IP address for the Oracle listener process on each node. Public virtual IP addresses are used by client applications to connect to the Oracle database and help mitigate TCP/IP timeout delays.

For Oracle 11g Release 2:

Additionally, you need a Single Client Access Name (SCAN) registered in Enterprise DNS that resolves to three IP addresses (recommended).

Oracle Clusterware/Grid Infrastructure manages the virtual IP addresses.

Planning the private network configuration for Oracle RAC

Oracle RAC requires a minimum of one private IP address on each node for Oracle Clusterware heartbeat.

Depending on the version of Oracle RAC you want to install, use one of the following options for setting up the private network configuration for Oracle database cache fusion:

Oracle RAC 10g Use either Oracle UDP IPC or VCSIPC/LMX/LLT for the database cache fusion traffic.

By default, the database cache fusion traffic is configured to use VCSIPC/LMX/LLT.

Oracle RAC 11g You must use UDP IPC for the database cache fusion traffic.

The Oracle UDP IPC protocol requires an IP address. Symantec recommends that an additional private IP address from a different subnet be used for load balancing the Oracle cache fusion traffic.

Note: The private IP addresses of all nodes that are on the same physical network must be in the same IP subnet.

The following practices provide a resilient private network setup:

- Configure Oracle Clusterware interconnects over LLT links to prevent data corruption.
 In an SF Oracle RAC cluster, the Oracle Clusterware heartbeat link **MUST** be configured as an LLT link. If Oracle Clusterware and LLT use different links for their communication, then the membership change between VCS and Oracle Clusterware is not coordinated correctly. For example, if only the Oracle Clusterware links are down, Oracle Clusterware kills one set of nodes after the expiry of the `css-miscount` interval and initiates the Oracle Clusterware and database recovery, even before CVM and CFS detect the node failures. This uncoordinated recovery may cause data corruption.
- Oracle Clusterware interconnects need to be protected against NIC failures and link failures. The PrivNIC or MultiPrivNIC agent can be used to protect against NIC failures and link failures, if multiple links are available. Even if link aggregation solutions in the form of bonded NICs are implemented, the PrivNIC or MultiPrivNIC agent can be used to provide additional protection against the failure of the aggregated link by failing over to available alternate links. These alternate links can be simple NIC interfaces or bonded NICs.
 An alternative option is to configure the Oracle Clusterware interconnects over bonded NIC interfaces.
 See [“High availability solutions for Oracle RAC private network”](#) on page 52.
- Configure Oracle Cache Fusion traffic to take place through the private network. Symantec also recommends that all UDP cache-fusion links be LLT links.

Note: The PrivNIC and MultiPrivNIC agents are not supported with Oracle RAC 11.2.0.2 and later versions. For more information, see <http://www.symantec.com/business/support/index?page=content&id=TECH145261>

Oracle database clients use the public network for database services. Whenever there is a node failure or network failure, the client fails over the connection, for both existing and new connections, to the surviving node in the cluster with which it is able to connect. Client failover occurs as a result of Oracle Fast Application Notification, VIP failover and client connection TCP timeout. It is strongly recommended not to send Oracle Cache Fusion traffic through the public network.

- Use NIC bonding to provide redundancy for public networks so that Oracle can fail over virtual IP addresses if there is a public link failure.

High availability solutions for Oracle RAC private network

Table 3-1 lists the high availability solutions that you may adopt for your private network.

Table 3-1 High availability solutions for Oracle RAC private network

Options	Description
Using link aggregation/ NIC bonding for Oracle Clusterware	<p>Use a native NIC bonding solution to provide redundancy, in case of NIC failures.</p> <p>Make sure that a link configured under a aggregated link or NIC bond is not configured as a separate LLT link.</p> <p>When LLT is configured over a bonded interface, do one of the following steps to prevent GAB from reporting jeopardy membership:</p> <ul style="list-style-type: none"> ■ Configure an additional NIC under LLT in addition to the bonded NIC. ■ Add the following line in the <code>/etc/llttab</code> file: <pre>set-dbg-minlinks 2</pre>
Using PrivNIC/MultiPrivNIC agents	<p>Note: The PrivNIC and MultiPrivNIC agents are not supported with Oracle RAC 11.2.0.2 and later versions. For more information, see http://www.symantec.com/business/support/index?page=content&id=TECH145261</p> <p>Use the PrivNIC agent when operating system limitations prevent you from using NIC bonding to provide high availability using multiple network interfaces.</p> <p>Use the MultiPrivNIC agent when operating system limitations prevent you from using NIC bonding to provide high availability and increased bandwidth using multiple network interfaces.</p> <p>For more deployment scenarios that illustrate the use of PrivNIC/MultiPrivNIC deployments, see the appendix "SF Oracle RAC deployment scenarios" in this document.</p>

Planning the storage

SF Oracle RAC provides the following options for shared storage:

- CVM
 - CVM provides native naming (OSN) as well as enclosure-based naming (EBN).

Use enclosure-based naming for easy administration of storage. Enclosure-based naming guarantees that the same name is given to a shared LUN on all the nodes, irrespective of the operating system name for the LUN.

- CFS
- Oracle ASM over CVM

The following recommendations ensure better performance and availability of storage.

- Use multiple storage arrays, if possible, to ensure protection against array failures. The minimum recommended configuration is to have two HBAs for each host and two switches.
- Design the storage layout keeping in mind performance and high availability requirements. Use technologies such as striping and mirroring.
- Use appropriate stripe width and depth to optimize I/O performance.
- Use SCSI-3 persistent reservations (PR) compliant storage.
- Provide multiple access paths to disks with HBA/switch combinations to allow DMP to provide high availability against storage link failures and to provide load balancing.

Planning the storage for SF Oracle RAC

[Table 3-2](#) lists the type of storage required for SF Oracle RAC.

Table 3-2 Type of storage required for SF Oracle RAC

SF Oracle RAC files	Type of storage
SF Oracle RAC binaries	Local
SF Oracle RAC fencing coordinator disks	Shared
SF Oracle RAC database storage management repository	Shared

Planning the storage for Oracle RAC

Review the storage options and guidelines for Oracle RAC:

- Storage options for OCR and voting disk
 See [“Planning the storage for OCR and voting disk”](#) on page 54.

- Storage options for the Oracle RAC installation directories (ORACLE_BASE, CRS_HOME or GRID_HOME (depending on Oracle RAC version), and ORACLE_HOME)
 See “[Planning the storage for Oracle RAC binaries and data files](#)” on page 55.

Planning the storage for OCR and voting disk

Depending on the Oracle RAC version, use one of the following options to place the OCR and voting disk information:

Oracle RAC 10g Release 2	Clustered File System CVM raw volumes
Oracle RAC 11g Release 2	Clustered File System ASM disk groups created using CVM raw volumes

Figure 3-1 illustrates the options for storing OCR and voting disk information.

Figure 3-1 OCR and voting disk storage options

Option 1: OCR and voting disk on CFS with two-way mirroring

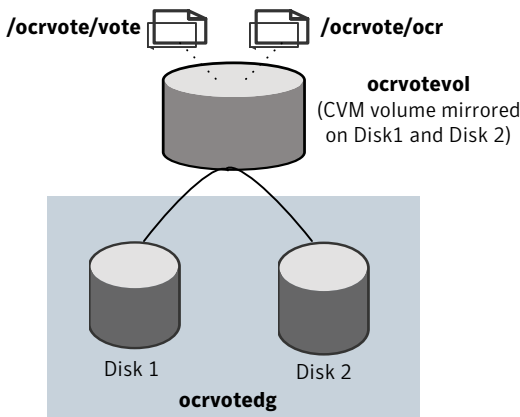

Option 2: OCR and voting disk on CVM raw volumes with two-way mirroring

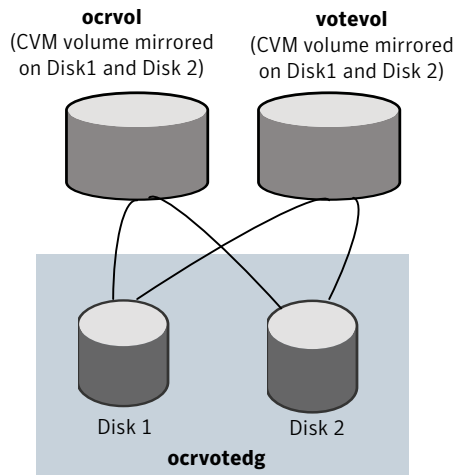

- If you want to place OCR and voting disk on a clustered file system (option 1), you need to have two separate files for OCR and voting information respectively on CFS mounted on a CVM mirrored volume.

- If you want to place OCR and voting disk on CVM raw volumes or on ASM disk groups that use CVM raw volumes (option 2), you need to use two CVM mirrored volumes for configuring OCR and voting disk on these volumes.

For both option 1 and option 2:

- The installer needs at least two LUNs of 640 MB each for creating the OCR and voting disk storage.
 Additionally, refer to the Oracle documentation for Oracle's recommendation on the required disk space for OCR and voting disk.
- The option **External Redundancy** must be selected at the time of installing Oracle Clusterware.

Note: Set the disk detach policy setting to (`local`) with `ioship` off for OCR and voting disk.

Once you have planned for the storage, you need to create the storage for OCR and voting disk manually as described later in the chapter "Installing Oracle RAC".

Note: For setting up replicated clusters, OCR and voting disk must be on non-replicated shared storage.

Planning the storage for Oracle RAC binaries and data files

The Oracle RAC binaries can be stored on local storage or on shared storage, based on your high availability requirements.

Note: Symantec recommends that you install the Oracle Clusterware and Oracle database binaries local to each node in the cluster.

Consider the following points while planning the installation:

- Local installations provide improved protection against a single point of failure and also allows for applying Oracle RAC patches in a rolling fashion.
- CFS installations provide a single Oracle installation to manage, regardless of the number of nodes. This scenario offers a reduction in storage requirements and easy addition of nodes.

[Table 3-3](#) lists the type of storage for Oracle RAC binaries and data files.

Table 3-3 Type of storage for Oracle RAC binaries and data files

Oracle RAC files	Type of storage
Oracle base	Local
Oracle Clusterware/Grid Infrastructure binaries	Local Placing the Oracle Grid Infrastructure binaries on local disks enables rolling upgrade of the cluster.
Oracle database binaries	Local Placing the Oracle database binaries on local disks enables rolling upgrade of the cluster.
Database datafiles	Shared Store the Oracle database files on CFS rather than on raw device or CVM raw device for easier management. Create separate clustered file systems for each Oracle database. Keeping the Oracle database datafiles on separate mount points enables you to unmount the database for maintenance purposes without affecting other databases. If you plan to store the Oracle database on ASM, configure the ASM disk groups over CVM volumes to take advantage of dynamic multi-pathing.
Database recovery data (archive, flash recovery)	Shared Place archived logs on CFS rather than on local file systems.

Planning for Oracle ASM over CVM

Review the following information on storage support provided by Oracle ASM:

Supported by ASM

ASM provides storage for data files, control files, online redo logs and archive log files, and backup files. Starting with Oracle RAC 11g Release 2, ASM also supports storage for OCR and voting disk.

Not supported by ASM

Oracle RAC 10g Release 2:

ASM does not support Oracle binaries, trace files, alert logs, export files, tar files, core files, Oracle Cluster Registry devices (OCR), and voting disk, and application binaries on ASM.

Oracle RAC 11g Release 2:

ASM does not support Oracle binaries, trace files, alert logs, export files, tar files, core files, and application binaries on ASM.

The following practices offer high availability and better performance:

- Use VxVM mirrored volumes with dynamic multi-pathing with external redundancy to ensure high availability.
- Do not use VxVM volumes, which are used by ASM, for any other purpose such as creation of file systems.
- Do not link the Veritas ODM library when databases are created on ASM.

Planning volume layout

The following recommendations ensure optimal layout of VxVM/CVM volumes:

- Mirror the volumes across two or more storage arrays, if using VxVM mirrors. Keep the Fast Mirror Resync regionsize equal to the database block size to reduce the copy-on-write (COW) overhead. Reducing the regionsize increases the amount of Cache Object allocations leading to performance overheads.
- Separate the Oracle recovery structures from the database files to ensure high availability when you design placement policies.
- Separate redo logs and place them on the fastest storage (for example, RAID 1+ 0) for better performance.
- Use "third-mirror break-off" snapshots for cloning the Oracle log volumes. Do not create Oracle log volumes on a Space-Optimized (SO) snapshot.
- Create as many Cache Objects (CO) as possible when you use Space-Optimized (SO) snapshots for Oracle data volumes.
- Distribute the I/O load uniformly on all Cache Objects when you create multiple Cache Objects.
- Implement zoning on SAN switch to control access to shared storage. Be aware that physical disks may be shared by multiple servers or applications and must therefore be protected from accidental access.

- Choose DMP I/O policy based on the storage network topology and the application I/O pattern.
- Exploit thin provisioning for better return on investment.

Planning file system design

The following recommendations ensure an optimal file system design for databases:

- If using VxVM mirroring, use ODM with CFS for better performance. ODM with SmartSync enables faster recovery of mirrored volumes using Oracle resilvering.
- Create separate file systems for Oracle binaries, data, redo logs, and archive logs. This ensures that recovery data is available if you encounter problems with database data files storage.
- Always place archived logs on CFS file systems rather than local file systems.

About planning to configure I/O fencing

After you configure SF Oracle RAC with the installer, you must configure I/O fencing in the cluster for data integrity.

You can configure disk-based I/O fencing or server-based I/O fencing. If your enterprise setup has multiple clusters that use VCS for clustering, Symantec recommends you to configure server-based I/O fencing.

The coordination points in server-based fencing can include only CP servers or a mix of CP servers and coordinator disks.

Note: Irrespective of whether you use coordinator disks or CP servers, SF Oracle RAC requires at least 3 coordination points.

[Figure 3-2](#) illustrates a high-level flowchart to configure I/O fencing for the SF Oracle RAC cluster.

Figure 3-2 Workflow to configure I/O fencing

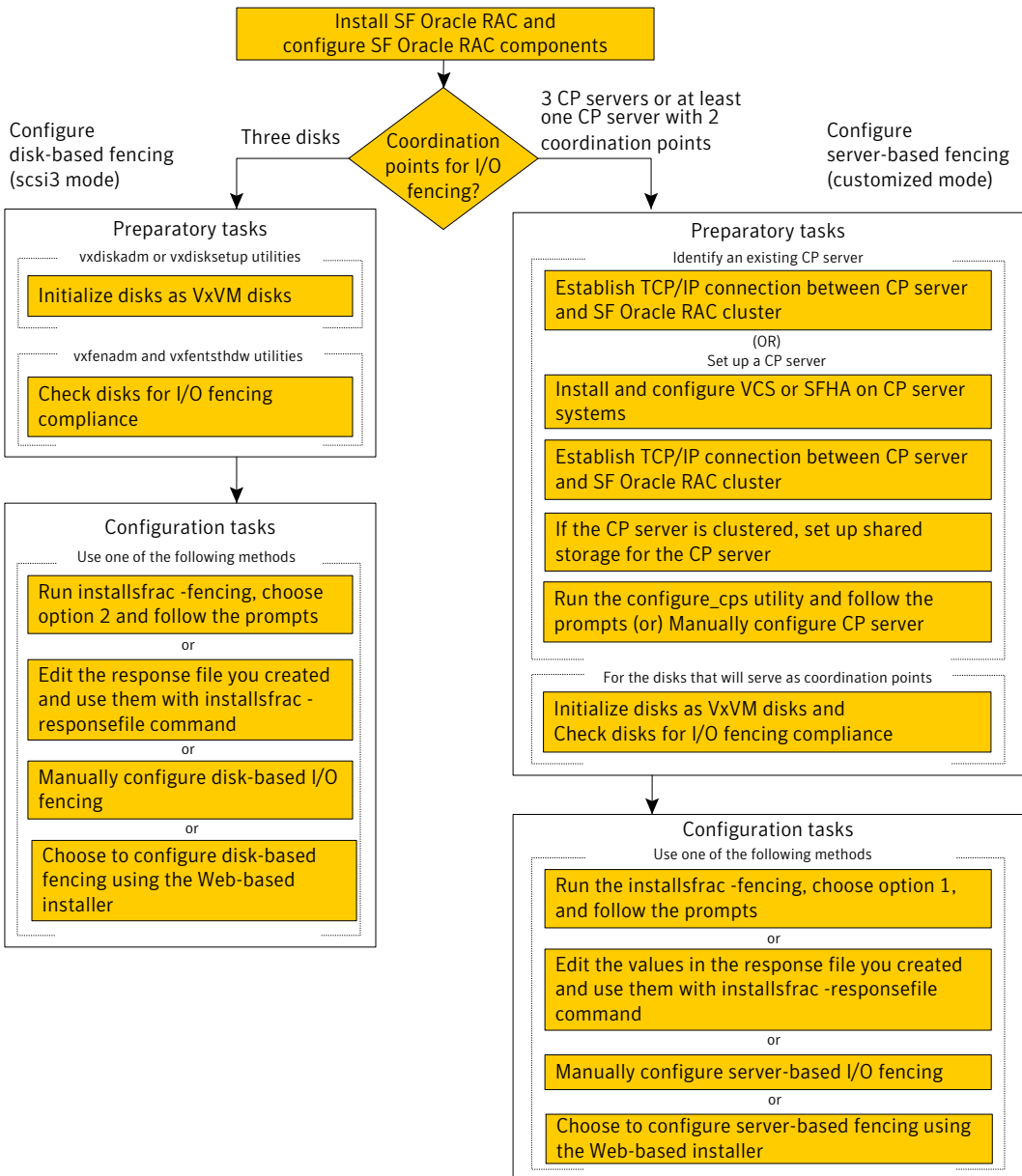

After you perform the preparatory tasks, you can use any of the following methods to configure I/O fencing:

- Using the `installsrac` See [“Setting up disk-based I/O fencing using `installsrac`”](#) on page 105.
 See [“Setting up server-based I/O fencing using `installsrac`”](#) on page 114.
- Using the Web-based installer See [“Configuring SF Oracle RAC for data integrity using the Web-based installer”](#) on page 130.
- Using response files See [“Response file variables to configure disk-based I/O fencing”](#) on page 379.
 See [“Response file variables to configure server-based I/O fencing”](#) on page 386.
 See [“Configuring I/O fencing using response files”](#) on page 378.

You can also migrate from one I/O fencing configuration to another.
 See the *Veritas Storage foundation High Availability Administrator’s Guide* for more details.

Typical SF Oracle RAC cluster configuration with disk-based I/O fencing

Figure 3-3 displays a typical VCS configuration with two nodes and shared storage. The configuration uses three coordinator disks for I/O fencing.

Figure 3-3 Typical SF Oracle RAC cluster configuration with disk-based I/O fencing

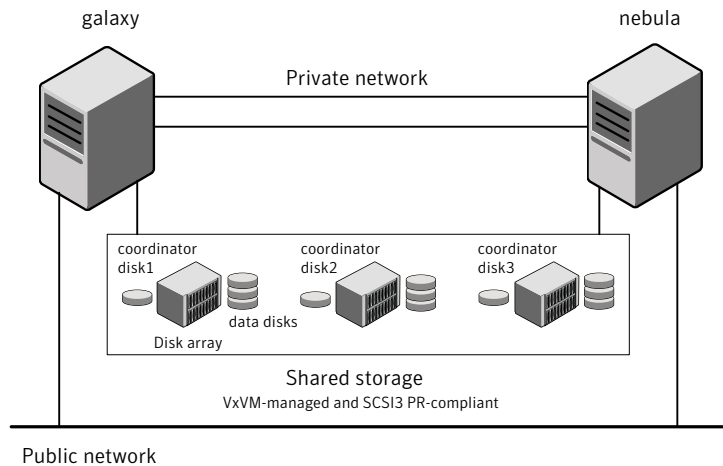

Typical SF Oracle RAC cluster configuration with server-based I/O fencing

Figure 3-4 displays a configuration using a SF Oracle RAC cluster (with two nodes), a single CP server, and two coordinator disks. The nodes within the SF Oracle RAC cluster are connected to and communicate with each other using LLT links.

Figure 3-4 CP server, SF Oracle RAC cluster, and coordinator disks

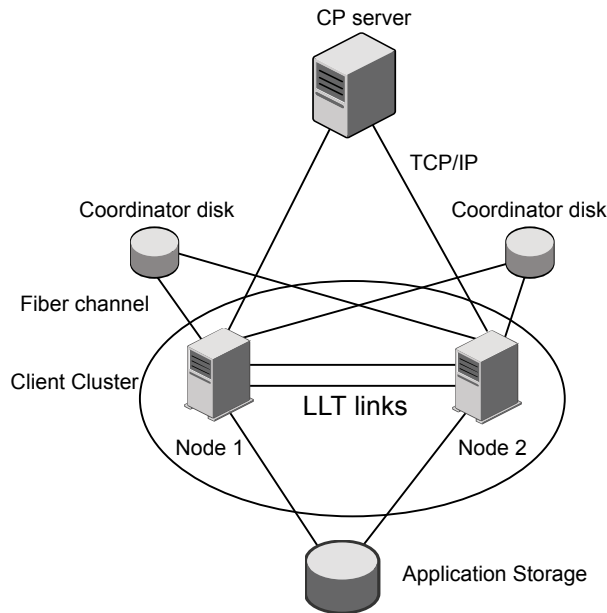

Recommended CP server configurations

Following are the recommended CP server configurations:

- Multiple application clusters use three CP servers as their coordination points
 See [Figure 3-5](#) on page 62.
- Multiple application clusters use a single CP server and single or multiple pairs of coordinator disks (two) as their coordination points
 See [Figure 3-6](#) on page 63.

Although the recommended CP server configurations use three coordination points, you can use more than three coordination points for I/O fencing. Ensure that the total number of coordination points you use is an odd number. In a configuration where multiple application clusters share a common set of CP server coordination

points, the application cluster as well as the CP server use a Universally Unique Identifier (UUID) to uniquely identify an application cluster.

Figure 3-5 displays a configuration using three CP servers that are connected to multiple application clusters.

Figure 3-5 Three CP servers connecting to multiple application clusters

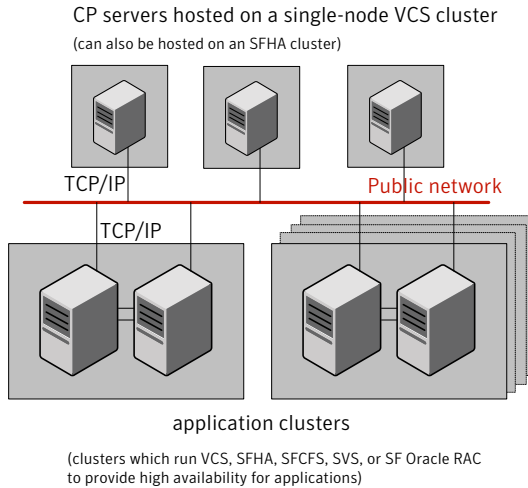
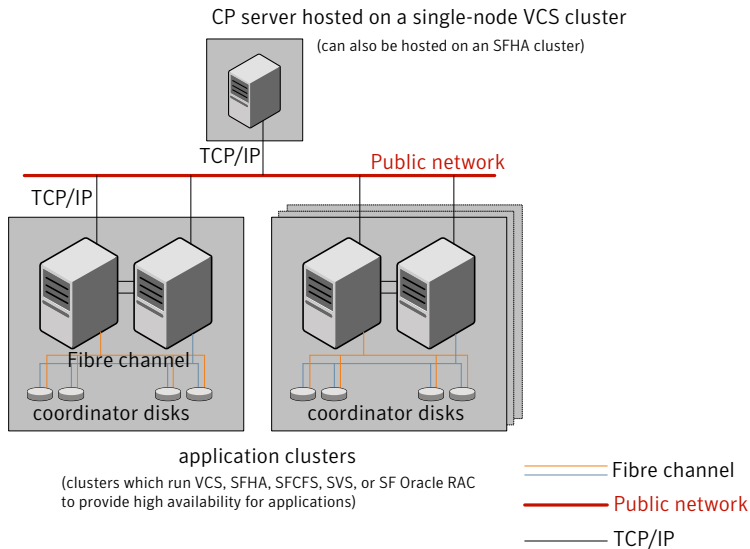

Figure 3-6 displays a configuration using a single CP server that is connected to multiple application clusters with each application cluster also using two coordinator disks.

Figure 3-6 Single CP server with two coordinator disks for each application cluster



See “[Configuration diagrams for setting up server-based I/O fencing](#)” on page 679.

Planning for cluster management

[Table 3-4](#) lists the various agents supported in SF Oracle RAC installations for effective cluster management.

Table 3-4 List of agents

Agent	Description
VCS agent for Oracle	Oracle database management The VCS Oracle agent is recommended for managing Oracle databases. VCS controls the Oracle database in this configuration.
VCS agent for ASMDG	Oracle ASM disk group monitoring The ASMDG agent monitors the Oracle ASM disk groups.
VCS agents for CVM	Volume management An SF Oracle RAC installation automatically configures the CVMCluster resource and the CVMVxconfigd resource. You must configure the CVMVolDg agent for each shared disk group.

Table 3-4 List of agents (*continued*)

Agent	Description
VCS agents for CFS	File system management If the database uses cluster file systems, configure the CFSMount agent for each volume in the disk group.
CSSD application agent (Application agent for Oracle Clusterware)	Oracle Clusterware management The CSSD application agent starts, stops, and monitors Oracle Clusterware. It ensures that the OCR, the voting disk and the private IP address resources required by Oracle Clusterware are online before Oracle Clusterware starts. Note: It is mandatory to use CSSD application agent in SF Oracle RAC installations to ensure adequate handling of inter-dependencies and thereby prevent the premature startup of Oracle Clusterware.
PrivNIC agent	High availability for a private IP address The PrivNIC agent provides a reliable alternative when operating system limitations prevent you from using NIC bonding to provide high availability using multiple network interfaces.
MultiPrivNIC agent	High availability for multiple private IP addresses The MultiPrivNIC agent provides a reliable alternative when operating system limitations prevent you from using NIC bonding to provide high availability and increased bandwidth using multiple network interfaces.
CRSResource agent	Oracle Clusterware resource monitoring. The CRSResource agent monitors the Oracle Clusterware resources such as the virtual IP address, listener, and the Oracle database instance. It provides an alternative mechanism for monitoring the Oracle database in the absence of the VCS Oracle agent. It is useful in scenarios where the database is not managed by VCS and the applications need to be started using VCS after Oracle Clusterware starts the database.

Note: Make sure that you do not configure the following Oracle resources under VCS: SCAN IP, virtual IP, and listener.

Licensing SF Oracle RAC

This chapter includes the following topics:

- [About Veritas product licensing](#)
- [Setting or changing the product level for keyless licensing](#)
- [Installing Veritas product license keys](#)

About Veritas product licensing

You have the option to install Veritas products without a license key. Installation without a license does not eliminate the need to obtain a license. A software license is a legal instrument governing the usage or redistribution of copyright protected software. The administrator and company representatives must ensure that a server or cluster is entitled to the license level for the products installed. Symantec reserves the right to ensure entitlement and compliance through auditing.

If you encounter problems while licensing this product, visit the Symantec licensing support website.

www.symantec.com/techsupp/

The Veritas product installer prompts you to select one of the following licensing methods:

- Install a license key for the product and features that you want to install.
When you purchase a Symantec product, you receive a License Key certificate. The certificate specifies the product keys and the number of product licenses purchased.
- Continue to install without a license key.
The installer prompts for the product modes and options that you want to install, and then sets the required product level.

Within 60 days of choosing this option, you must install a valid license key corresponding to the license level entitled. If you do not comply with the above terms, continuing to use the Symantec product is a violation of your end user license agreement, and results in warning messages.

For more information about keyless licensing, see the following URL:

<http://go.symantec.com/sfhakeyless>

If you upgrade to this release from a prior release of the Veritas software, the installer asks whether you want to upgrade the key to the new version. The existing license keys may not activate new features in this release.

If you upgrade with the product installer, or if you install or upgrade with a method other than the product installer, you must do one of the following to license the products:

- Run the `vxkeyless` command to set the product level for the products you have purchased. This option also requires that you manage the server or cluster with a management server.
See “[Setting or changing the product level for keyless licensing](#)” on page 68.
See the `vxkeyless(1m)` manual page.
- Use the `vxlicinst` command to install a valid product license key for the products you have purchased.
See “[Installing Veritas product license keys](#)” on page 69.
See the `vxlicinst(1m)` manual page.

You can also use the above options to change the product levels to another level that you are authorized to use. For example, you can add the replication option to the installed product. You must ensure that you have the appropriate license for the product level and options in use.

Note: In order to change from one product group to another, you may need to perform additional steps.

About SF Oracle RAC licenses

[Table 4-1](#) lists the various SF Oracle RAC license levels in keyless licensing and the corresponding features.

Note: The `SFRACENT_VFR` and `SFRACENT_VFR_GCO` licenses are not supported.

Table 4-1 SF Oracle RAC license levels (keyless licensing)

License	Description	Features enabled
SFRACENT	SF Oracle RAC Enterprise Edition	The license enables the following features: <ul style="list-style-type: none"> ■ Veritas Volume Manager ■ Veritas Storage and Availability Management Tools for Oracle databases ■ Veritas Extension for ODM ■ Veritas File System ■ Veritas Cluster Server ■ Veritas Mapping Services
SFRACENT_VR	SF Oracle RAC Enterprise Edition with VR (Veritas Replicator)	The license enables the following features: <ul style="list-style-type: none"> ■ Veritas Volume Manager Veritas Volume Replicator is enabled. ■ Veritas Storage and Availability Management Tools for Oracle databases ■ Veritas Extension for ODM ■ Veritas File System ■ Veritas Cluster Server ■ Veritas Mapping Services
SFRACENT_GCO	SF Oracle RAC Enterprise Edition with GCO (Global Cluster Option)	The license enables the following features: <ul style="list-style-type: none"> ■ Veritas Volume Manager ■ Veritas Storage and Availability Management Tools for Oracle databases ■ Veritas Extension for ODM ■ Veritas File System ■ Veritas Cluster Server Global Cluster Option is enabled. ■ Veritas Mapping Services

Table 4-1 SF Oracle RAC license levels (keyless licensing) (*continued*)

License	Description	Features enabled
SFRACENT_VR_GCO	SF Oracle RAC Enterprise Edition with VR and GCO	The license enables the following features: <ul style="list-style-type: none">■ Veritas Volume Manager Veritas Volume Replicator is enabled.■ Veritas Storage and Availability Management Tools for Oracle databases■ Veritas Extension for ODM■ Veritas File System■ Veritas Cluster Server Global Cluster Option is enabled.■ Veritas Mapping Services

Setting or changing the product level for keyless licensing

The keyless licensing method uses product levels to determine the Veritas products and functionality that are licensed.

For more information to use keyless licensing and to download the management server, see the following URL:

<http://go.symantec.com/vom>

When you set the product license level for the first time, you enable keyless licensing for that system. If you install with the product installer and select the keyless option, you are prompted to select the product and feature level that you want to license.

After you install, you can change product license levels at any time to reflect the products and functionality that you want to license. When you set a product level, you agree that you have the license for that functionality.

To set or change the product level

- 1 Change your current working directory:

```
# cd /opt/VRTSvlic/bin
```

- 2 View the current setting for the product level.

```
# ./vxkeyless -v display
```

- 3 View the possible settings for the product level.

```
# ./vxkeyless displayall
```

- 4 Set the desired product level.

```
# ./vxkeyless set prod_levels
```

where *prod_levels* is a comma-separated list of keywords. The keywords are the product levels as shown by the output of step 3.

If you want to remove keyless licensing and enter a key, you must clear the keyless licenses. Use the NONE keyword to clear all keys from the system.

Warning: Clearing the keys disables the Veritas products until you install a new key or set a new product level.

To clear the product license level

- 1 View the current setting for the product license level.

```
# ./vxkeyless [-v] display
```

- 2 If there are keyless licenses installed, remove all keyless licenses:

```
# ./vxkeyless [-q] set NONE
```

For more details on using the `vxkeyless` utility, see the `vxkeyless (1m)` manual page.

Installing Veritas product license keys

The VRTSVlic depot enables product licensing. After the VRTSVlic is installed, the following commands and their manual pages are available on the system:

<code>vxlicinst</code>	Installs a license key for a Symantec product
<code>vxlicrep</code>	Displays currently installed licenses
<code>vxlictest</code>	Retrieves features and their descriptions encoded in a license key

Even though other products are included on the enclosed software discs, you can only use the Symantec software products for which you have purchased a license.

To install a new license

- ◆ Run the following commands. In a cluster environment, run the commands on each node in the cluster:

```
# cd /opt/VRTS/bin  
  
# ./vxlicinst -k license key
```

To see a list of your vxkeyless keys, enter the following command:

```
# ./vxkeyless display
```

After you upgrade from a previous release, the output you see when you run the `vxkeyless display` command includes the previous release's vxkeyless keys. Each vxkeyless key name includes the suffix `_<previous_release_version>`. For example, `DMP_6.0`, or `SFENT_VR_5.1SP1`, or `VCS_GCO_5.1`. During the upgrade process, the CPI installer prompts you to update the vxkeyless keys to the current release level. If you update the vxkeyless keys during the upgrade process, you no longer see the `_<previous_release_number>` suffix after the keys are updated.

Preparing to install and configure SF Oracle RAC

- [Chapter 5. Preparing to install SF Oracle RAC](#)

Preparing to install SF Oracle RAC

This chapter includes the following topics:

- [Preparing to configure server-based fencing for SF Oracle RAC](#)
- [Setting the umask before installation](#)
- [Synchronizing time settings on cluster nodes](#)
- [Mounting the product disc](#)
- [Setting up shared storage](#)
- [Setting the environment variables for SF Oracle RAC](#)
- [Optimizing LLT media speed settings on private NICs](#)
- [Verifying the systems before installation](#)
- [About installation and configuration methods](#)
- [About the Veritas installer](#)

Preparing to configure server-based fencing for SF Oracle RAC

If you plan to use server-based I/O fencing, you need to configure the coordination point (CP) server on a single-node VCS cluster or on an SFHA cluster. Symantec recommends hosting the CP server on an SFHA cluster to make the CP server highly available.

For instructions on configuring the CP server, see the *Veritas Cluster Server Installation Guide*.

Setting the umask before installation

Set the umask to provide appropriate permissions for SF Oracle RAC binaries and files. This setting is valid only for the duration of the current session.

```
# umask 0022
```

Synchronizing time settings on cluster nodes

Make sure that the time settings on all cluster nodes are synchronized.

Note: For Oracle RAC 11g Release 2, it is mandatory to configure NTP for synchronizing time on all nodes in the cluster.

For instructions, see the operating system documentation.

Mounting the product disc

You must have superuser (root) privileges to load the SF Oracle RAC software.

You can unmount the product disc after completing the SF Oracle RAC installation.

To mount the product disc

- 1 Log in as the superuser to a cluster node or a remote node in the same subnet as the cluster nodes.
- 2 Insert the product disc with the SF Oracle RAC software into a drive that is connected to the system.
- 3 Identify the block device file for the disc drive:

```
# ioscan -fnC disk
```

Make a note of the device file as it applies to your system.

- 4 Create a directory in which to mount the software disc. Then, mount the disc using the appropriate drive name:

```
# mkdir -p /dvd_mount
# mount /dev/dsk/c3t2d0 /dvd_mount
```

5 Verify that the disc is mounted:

```
# mount
```

Setting up shared storage

You need to set up shared storage to meet the following requirements:

- The LUNs from the shared storage must be visible to all the nodes in the cluster as seen by the following command:

```
# ioscan -fnC disk
```

For more information on setting up shared storage, see the *Veritas Cluster Server Installation Guide*.

Setting the environment variables for SF Oracle RAC

Set the MANPATH variable in the .profile file (or other appropriate shell setup file for your system) to enable viewing of manual pages.

Based on the shell you use, type one of the following:

```
For sh, ksh, or bash # MANPATH=/usr/share/man:/opt/VRTS/man
# export MANPATH
```

Set the PATH environment variable in the .profile file (or other appropriate shell setup file for your system) on each system to include installation and other commands.

Note: Do not define \$ORACLE_HOME/lib in LIBPATH for root user. You should define \$ORACLE_HOME/lib in LIBPATH for the oracle user.

Based on the shell you use, type one of the following:

```
For sh, ksh, or bash # PATH=/usr/sbin:/sbin:/usr/bin:\
/opt/VRTS/bin:\
$PATH; export PATH
```

Optimizing LLT media speed settings on private NICs

For optimal LLT communication among the cluster nodes, the interface cards on each node must use the same media speed settings. Also, the settings for the switches or the hubs that are used for the LLT interconnections must match that of the interface cards. Incorrect settings can cause poor network performance or even network failure.

If you use different media speed for the private NICs, Symantec recommends that you configure the NICs with lesser speed as low-priority links to enhance LLT performance.

Guidelines for setting the media speed of the LLT interconnects

Review the following guidelines for setting the media speed of the LLT interconnects:

- Symantec recommends that you manually set the same media speed setting on each Ethernet card on each node.
If you use different media speed for the private NICs, Symantec recommends that you configure the NICs with lesser speed as low-priority links to enhance LLT performance.
- If you have hubs or switches for LLT interconnects, then set the hub or switch port to the same setting as used on the cards on each node.

Details for setting the media speeds for specific devices are outside of the scope of this manual. Consult the device's documentation or the operating system manual for more information.

Verifying the systems before installation

Use any of the following options to verify your systems before installation:

- Option 1: Run Symantec Operations Readiness Tools (SORT).
For information on downloading and running SORT:
<https://sort.symantec.com>
- Option 2: Run the `installsfrac` with the `"-precheck"` option as follows:
Navigate to the directory that contains the `installsfrac` program.
The program is located in the `storage_foundation_for_oracle_rac` directory.
Start the preinstallation check:

```
# ./installsfrac -precheck node_1 node_2
```

where `node_1`, `node_2` are the names of the nodes in the cluster.

The program proceeds in a non-interactive mode, examining the systems for licenses, depots, disk space, and system-to-system communications. The program displays the results of the check and saves them in a log file. The location of the log file is displayed at the end of the precheck process.

- Option 3: Run the Veritas Web-based installation program as follows:
 - Navigate to the directory that contains the Web-based installation program and start the installer:

```
# ./webinstaller start
```

Paste the link in the address bar of the Web browser to access the installer.

- On the Select a task and a product page, select **Perform a Pre-installation check** from the **Task** drop-down list.
 Select the product from the **Product** drop-down list, and click **Next**.
 Enter the names of the systems that you want to verify.
 The installer performs the precheck and displays the results.

About installation and configuration methods

You can use one of the following methods to install and configure SF Oracle RAC.

Table 5-1 Installation and configuration methods

Method	Description
Interactive installation and configuration using the script-based installer Note: If you obtained SF Oracle RAC from an electronic download site, you must use the <code>installsfrac</code> script instead of the <code>installer</code> script.	You can use one of the following script-based installers: <ul style="list-style-type: none"> ■ Common product installer script: <code>installer</code> The common product installer script provides a menu that simplifies the selection of installation and configuration options. ■ Product-specific installation script: <code>installsfrac</code> ■ The product-specific installation script provides command-line interface options. Installing and configuring with the <code>installsfrac</code> script is identical to specifying SF Oracle RAC from the <code>installer</code> script. Use this method to install or configure only SF Oracle RAC.

Table 5-1 Installation and configuration methods (*continued*)

Method	Description
Silent installation using the response file	<p>The response file automates installation and configuration by using system and configuration information stored in a specified file instead of prompting for information. You can use the script-based installers with the response file to install silently on one or more systems.</p> <p>See “About response files” on page 353.</p>
Web-based installer	<p>The Web-based installer provides an interface to manage the installation and configuration from a remote site using a standard Web browser.</p> <p><code>webinstaller</code></p>

About the Veritas installer

To install your Veritas product, use one of the following methods:

- The general product installer. The general product installer enables you to install and configure the product, verify preinstallation requirements, and view the product’s description. You perform the installation from a disc, and you are prompted to choose a product to install.

See [“Installing SF Oracle RAC using the Veritas script-based installation program”](#) on page 81.
- Product-specific installation scripts. If you obtained a standalone Veritas product from an electronic download site, the single product download files do not contain the general product installer. Use the product installation script to install the individual products. You can find these scripts at the root of the product media in the scripts directory. These scripts are also installed with the product.

[Table 5-2](#) lists all the SFHA Solutions product installation scripts. The list of product installation scripts that you find on your system depends on the product that you install on your system.

Note: The name of the script is different depending on whether you run the script from the install media or from a system on which the product software is installed.

Table 5-2 Product installation scripts

Veritas product name	Product installation script (When running the script from the install media)	Product installation script (When running the script from a system on which the SFHA Solutions product is installed)
Veritas Cluster Server (VCS)	<code>installvcs</code>	<code>installvcs<version></code>
Veritas Storage Foundation (SF)	<code>installsf</code>	<code>installsf<version></code>
Veritas Storage Foundation and High Availability (SFHA)	<code>installsfha</code>	<code>installsfha<version></code>
Veritas Storage Foundation Cluster File System High Availability (SFCFSHA)	<code>installsfcfsha</code>	<code>installsfcfsha<version></code>
Veritas Storage Foundation for Oracle RAC (SF Oracle RAC)	<code>installsfrac</code>	<code>installsfrac<version></code>
Veritas Dynamic Multi-Pathing	<code>installdmp</code>	<code>installdmp<version></code>

The scripts that are installed on the system include the product version in the script name. For example, to install the SF Oracle RAC script from the install media, run the `installsfrac` command. However, to run the script from the installed binaries, run the `installsfrac<version>` command.

For example, for the 6.0.1 version:

```
# /opt/VRTS/install/installsfrac601 -configure
```

Note: Do not include the release version if you use the general product installer to install the product.

At most points during the installation you can type the following characters for different actions:

- Use `b` (back) to return to a previous section of the installation procedure. The back feature of the installation scripts is context-sensitive, so it returns to the beginning of a grouped section of questions.
- Use `Control+c` to stop and exit the program if an installation procedure hangs. After a short delay, the script exits.

- Use `q` to quit the installer.
- Use `?` to display help information.
- Use the Enter button to accept a default response.

See [“Installation script options”](#) on page 502.

Installation of SF Oracle RAC using the script-based installer

- [Chapter 6. Installing SF Oracle RAC](#)
- [Chapter 7. Configuring SF Oracle RAC](#)

Installing SF Oracle RAC

This chapter includes the following topics:

- [Installing SF Oracle RAC using the Veritas script-based installation program](#)

Installing SF Oracle RAC using the Veritas script-based installation program

Before you start the installation, make sure that you have the installation and configuration worksheet with the values on hand for the installation.

See “[SF Oracle RAC worksheet](#)” on page 523.

During the installation, the installer performs the following tasks:

- Verifies system readiness for installation by checking system communication, network speed, installed depots, operating system patches, swap space, and available volume space.

Note: If the installer reports that any of the patches are not available, install the patches on the system before proceeding with the SF Oracle RAC installation.

- Installs the SF Oracle RAC 6.0.1 depots.

If you encounter issues during the installation, see the *Veritas Storage Foundation for Oracle RAC Administrator's Guide*, Chapter "Performance and troubleshooting" for information on resolving the issue.

The following sample procedure installs SF Oracle RAC on two systems—sys1 and sys2.

To install SF Oracle RAC

- 1 Review the installer note on VxVM and confirm if you want to proceed with the installation.

The installer replaces any previous VxVM version with VxVM 6.0.1.

- 2 Log in as the superuser on one of the systems.
- 3 Start the installation program:

```
SF Oracle   Run the program:
RAC installer # ./installsfrac sys1 sys2
```

```
Common      Navigate to the directory that contains the installation program.
product     Run the program:
installer
```

```
# ./installer sys1 sys2
```

From the opening Selection Menu, choose: "I" for "Install a Product."

From the displayed list of products to install, choose **Veritas Storage Foundation for Oracle RAC**.

The installer displays the copyright message and specifies the directory where the running logs are created.

- 4 Set up the systems so that commands between systems execute without prompting for passwords or confirmations.

```
Would you like the installer to setup ssh or rsh communication
automatically between the systems?
```

```
Superuser passwords for the systems will be asked. [y,n,q] (y)
```

```
Enter the superuser password for system sys1:
```

- 1) Setup ssh between the systems
- 2) Setup rsh between the systems
- b) Back to previous menu

```
Select the communication method [1-2,b,q,?] (1)
```

- 5 If you had quit the installer in the process of an active installation, the installer discovers that installer process and provides the option of resuming the installation or starting a new installation. Provide a suitable response.

```
The installer has discovered an existing installer process.
```

```
The process exited while performing installation of SF Oracle RAC
```

Installing SF Oracle RAC using the Veritas script-based installation program

on sys1.

Do you want to resume this process? [y,n,q,?] (y) **n**

- 6 Enter **y** to agree to the End User License Agreement (EULA).
- 7 Select the type of installation—Minimal, Recommended, All. Each option displays the disk space that is required for installation.

Symantec recommends you to choose the option **Install all depots**.

```
1) Install minimal required depots
2) Install recommended depots
3) Install all depots
4) Display depots to be installed for each option
Select the depots to be installed on all systems?
[1-4,q,?] (2) 3
```

The installer verifies the systems for compatibility and displays the list of depots and patches that will be installed.

The installer installs the SF Oracle RAC depots and patches.

- 8 Select the appropriate license option.

```
1) Enter a valid license key
2) Enable keyless licensing and complete
system licensing later
How would you like to license the systems? [1-2,q]
```

- Enter **1** if you have a valid license key. When prompted, enter the license key.

Enter a SF Oracle RAC license key:

```
xxxx-xxxx-xxxx-xxxx-xxxx-xxxx-xxxx-xxxx-x
```

If you plan to enable additional capabilities, enter the corresponding license keys when you are prompted for additional licenses.

```
Do you wish to enter additional licenses? [y,n,q,b] (n)
```

- Enter **2** to enable keyless licensing.

Note: The keyless license option enables you to install SF Oracle RAC without entering a key. However, you must still acquire a valid license to install and use SF Oracle RAC. Keyless licensing requires that you manage the systems with a Management Server.

Enter **y** if you want to enable replication or configure Global Cluster Option (GCO) during the installation. Replication is configured with default values while GCO is configured with the settings you specify. You can reconfigure replication and GCO manually at any time.

```
Would you like to enable the
Veritas Volume Replicator? [y,n,q] (n)
Would you like to enable the
Global Cluster Option? [y,n,q] (n)
```

The installer registers the license.

- 9 Verify that the installation process completed successfully. Review the output at the end of the installation and note the location of the summary and log files for future reference.
- 10 Enter **y** if you want to send the installation information to Symantec.

```
Would you like to send the information about this installation
to Symantec to help improve installation in the future? [y,n,q,?] (y) y
```

- 11 Restart the nodes after installation. Some of the depots require a restart operation before you can proceed to configure SF Oracle RAC.

Note: Do not use the reboot command to restart the nodes.

```
# /usr/sbin/shutdown -r now
```

- 12 Enter **y** if you want to view the summary file.

```
Would you like to view the summary file? [y,n,q] (n) y
```

Configuring SF Oracle RAC

This chapter includes the following topics:

- [Configuring the SF Oracle RAC components using the script-based installer](#)
- [Setting up disk-based I/O fencing using `installsfrac`](#)
- [Setting up server-based I/O fencing using `installsfrac`](#)

Configuring the SF Oracle RAC components using the script-based installer

Make sure that you have performed the necessary pre-configuration tasks if you want to configure the cluster in secure mode.

Start the `installsfrac` or `installer` program if you quit the installer after installation.

By default, the communication between the systems is selected as SSH. If SSH is used for communication between systems, the SSH commands execute without prompting for passwords or confirmations.

At the end of the configuration, the VCS, CVM, and CFS components are configured to provide a cluster-aware environment.

Note: If you want to reconfigure SF Oracle RAC, before you start the installer you must stop all the resources that are under VCS control using the `hasstop` command or the `hagrp -offline` command. For resources that are not configured under VCS, use native application commands to stop the resources.

If you encounter issues during the configuration, see the *Veritas Storage Foundation for Oracle RAC Administrator's Guide*, Chapter "Performance and troubleshooting" for information on resolving the issue.

To configure the SF Oracle RAC components

- 1 Log in as the superuser on any of the nodes in the cluster.
- 2 Start the configuration program.

SF Oracle RAC installer Run the program:

```
# cd /opt/VRTS/install
# ./installsfrac<version> -configure \
  sys1 sys2
```

Where <version> is the specific release version.

See [“About the Veritas installer”](#) on page 77.

Common product installer Run the program:

```
# ./installer -configure \
  sys1 sys2
```

Choose **Veritas Storage Foundation for Oracle RAC** to configure SF Oracle RAC.

The installer displays the copyright message and specifies the directory where the logs are created.

3 Select the option **Configure SF Oracle RAC sub-components**.

```
1) Configure SF Oracle RAC sub-components
2) Prepare to Install Oracle
3) Install Oracle Clusterware/Grid Infrastructure and Database
4) Post Oracle Installation Tasks
5) Exit SF Oracle RAC Configuration
Choose option: [1-5,q] (1)
```

- 4 If you had quit the installer in the process of an active configuration, the installer discovers that installer process and provides the option of resuming the configuration or starting a new configuration. Provide a suitable response.

```
The installer has discovered an existing installer process.
The process exited while performing configure of
SF Oracle RAC on sys1.
Do you want to resume this process? [y,n,q,?] (y) n
```

- 5 Configure the Veritas Cluster Server component to set up the SF Oracle RAC cluster.
See [“Configuring the SF Oracle RAC cluster”](#) on page 87.
- 6 Add VCS users.
See [“Adding VCS users”](#) on page 98.
- 7 Configure SMTP email notification.
See [“Configuring SMTP email notification”](#) on page 99.
- 8 Configure SNMP trap notification.
See [“Configuring SNMP trap notification”](#) on page 101.
- 9 Configure global clusters, if you chose to enable GCO during the installation.
See [“Configuring global clusters”](#) on page 103.
- 10 Stop the SF Oracle RAC resources.
See [“Stopping and starting SF Oracle RAC processes”](#) on page 104.

Configuring the SF Oracle RAC cluster

You must configure the Veritas Cluster Server component to set up the SF Oracle RAC cluster.

You can configure a basic cluster or an advanced cluster. A basic cluster configuration requires the cluster name and ID and the private heartbeat links for LLT. The remaining configuration options presented by the installer are optional and may be used if you plan to configure an advanced cluster.

Refer to the *Veritas Cluster Server Installation Guide* for more information.

Configuring the cluster name

Enter the cluster information when the installer prompts you.

To configure the cluster

- 1 Review the configuration instructions that the installer presents.
- 2 Enter a unique cluster name.

```
Enter the unique cluster name: [q,?] clus1
```

Configuring private heartbeat links

You now configure the private heartbeat links that LLT uses. VCS provides the option to use LLT over Ethernet or over UDP (User Datagram Protocol). Symantec recommends that you configure heartbeat links that use LLT over Ethernet for high performance, unless hardware requirements force you to use LLT over UDP. If you want to configure LLT over UDP, make sure you meet the prerequisites.

The following procedure helps you configure LLT over Ethernet.

To configure private heartbeat links

- 1 Choose one of the following options at the installer prompt based on whether you want to configure LLT over Ethernet or UDP.
 - Option 1: LLT over Ethernet (answer installer questions)
Enter the heartbeat link details at the installer prompt to configure LLT over Ethernet.
Skip to step 2.
 - Option 2: LLT over UDP (answer installer questions)
Make sure that each NIC you want to use as heartbeat link has an IP address configured. Enter the heartbeat link details at the installer prompt to configure LLT over UDP. If you had not already configured IP addresses to the NICs, the installer provides you an option to detect the IP address for a given NIC.
Skip to step 3.
 - Option 3: Automatically detect configuration for LLT over Ethernet
Allow the installer to automatically detect the heartbeat link details to configure LLT over Ethernet. The installer tries to detect all connected links between all systems.
Skip to step 5.

Note: Option 3 is not available when the configuration is a single node configuration.

- 2 If you chose option 1, enter the network interface card details for the private heartbeat links.

The installer discovers and lists the network interface cards.

You must not enter the network interface card that is used for the public network (typically lan0.)

```

Enter the NIC for the first private heartbeat link on sys1:
[b,q,?] lan1
lan1 has an IP address configured on it. It could be a
public NIC on sys1.
Are you sure you want to use lan1 for the first private
heartbeat link? [y,n,q,b,?] (n) y
Would you like to configure a second private heartbeat link?
[y,n,q,b,?] (y)
Enter the NIC for the second private heartbeat link on sys1:
[b,q,?] lan2
lan2 has an IP address configured on it. It could be a
public NIC on sys1.
Are you sure you want to use lan2 for the second private
heartbeat link? [y,n,q,b,?] (n) y
Would you like to configure a third private heartbeat link?
[y,n,q,b,?] (n)
    
```

- 3** If you chose option 2, enter the NIC details for the private heartbeat links. This step uses examples such as *private_NIC1* or *private_NIC2* to refer to the available names of the NICs.

```

Enter the NIC for the first private heartbeat
link on sys1: [b,q,?] private_NIC1
Do you want to use address 192.168.0.1 for the
first private heartbeat link on sys1: [y,n,q,b,?] (y)
Enter the UDP port for the first private heartbeat
link on sys1: [b,q,?] (50000) ?
Would you like to configure a second private
heartbeat link? [y,n,q,b,?] (y)
Enter the NIC for the second private heartbeat
link on sys1: [b,q,?] private_NIC2
Do you want to use address 192.168.1.1 for the
second private heartbeat link on sys1: [y,n,q,b,?] (y)
Enter the UDP port for the second private heartbeat
link on sys1: [b,q,?] (50001) ?
Do you want to configure an additional low priority
heartbeat link? [y,n,q,b,?] (n) y
Enter the NIC for the low priority heartbeat
link on sys1: [b,q,?] (private_NIC0)
Do you want to use address 192.168.3.1 for
the low priority heartbeat link on sys1: [y,n,q,b,?] (y)
Enter the UDP port for the low priority heartbeat
link on sys1: [b,q,?] (50004)

```

- 4** Choose whether to use the same NIC details to configure private heartbeat links on other systems.

```

Are you using the same NICs for private heartbeat links on all
systems? [y,n,q,b,?] (y)

```

If you want to use the NIC details that you entered for sys1, make sure the same NICs are available on each system. Then, enter **y** at the prompt.

For LLT over UDP, if you want to use the same NICs on other systems, you still must enter unique IP addresses on each NIC for other systems.

If the NIC device names are different on some of the systems, enter **n**. Provide the NIC details for each system as the program prompts.

- 5 If you chose option 3, the installer detects NICs on each system and network links, and sets link priority.

If the installer fails to detect heartbeat links or fails to find any high-priority links, then choose option 1 or option 2 to manually configure the heartbeat links.

See step 2 for option 1, or step 3 for option 2.

- 6 Enter a unique cluster ID:

```
Enter a unique cluster ID number between 0-65535: [b,q,?] (60842)
```

The cluster cannot be configured if the cluster ID 60842 is in use by another cluster. Installer performs a check to determine if the cluster ID is duplicate. The check takes less than a minute to complete.

```
Would you like to check if the cluster ID is in use by another
cluster? [y,n,q] (y)
```

- 7 Verify and confirm the information that the installer summarizes.

A basic cluster is now configured. The remaining configuration settings are optional.

Note: You can proceed through the subsequent screens by just accepting the default value **n**.

Configuring the virtual IP of the cluster

You can configure the virtual IP of the cluster to use to connect from the Cluster Manager (Java Console), Veritas Operations Manager (VOM), or to specify in the RemoteGroup resource.

See the *Veritas Cluster Server Administrator's Guide* for information on the Cluster Manager.

See the *Veritas Cluster Server Bundled Agents Reference Guide* for information on the RemoteGroup agent.

To configure the virtual IP of the cluster

- 1 Review the required information to configure the virtual IP of the cluster.
- 2 When the system prompts whether you want to configure the virtual IP, enter `y`.
- 3 Confirm whether you want to use the discovered public NIC on the first system. Do one of the following:
 - If the discovered NIC is the one to use, press `Enter`.

- If you want to use a different NIC, type the name of a NIC to use and press Enter.

```
Active NIC devices discovered on sys1: lan0
Enter the NIC for Virtual IP of the Cluster to use on sys1:
[b,q,?] (lan0)
```

4 Confirm whether you want to use the same public NIC on all nodes.

Do one of the following:

- If all nodes use the same public NIC, enter *y*.
- If unique NICs are used, enter *n* and enter a NIC for each node.

```
Is lan0 to be the public NIC used by all systems
[y,n,q,b,?] (y)
```

5 Enter the virtual IP address for the cluster.

```
Enter the Virtual IP address for the Cluster:
[b,q,?] 192.168.1.16
```

6 Confirm the default netmask or enter another one:

```
Enter the netmask for IP 192.168.1.16: [b,q,?] (255.255.240.0)
```

7 Enter the NetworkHosts IP addresses that are separated with spaces for checking the connections.

```
Enter the NetworkHosts IP addresses, separated by
spaces: [b,q,?] 192.168.1.17
```

8 Verify and confirm the Cluster Virtual IP information.

```
Cluster Virtual IP verification:
```

```
NIC: lan0
IP: 192.168.1.16
Netmask: 255.255.240.0

NetworkHosts: 192.168.1.17
```

```
Is this information correct? [y,n,q] (y)
```

If you want to set up trust relationships for your secure cluster, refer to the following topics:

See [“Setting up trust relationships for your SF Oracle RAC cluster”](#) on page 93.

See [“Configuring a secure cluster node by node”](#) on page 95.

Configuring Veritas Storage Foundation for Oracle RAC in secure mode

Configuring SF Oracle RAC in secure mode ensures that all the communication between the systems is encrypted and users are verified against security credentials. SF Oracle RAC user names and passwords are not used when a cluster is running in secure mode. You can select the secure mode to be FIPS compliant while configuring the secure mode.

To configure SF Oracle RAC in secure mode

- 1 Enter appropriate choices when the installer prompts you:

```
Would you like to configure the VCS cluster in
secure mode [y,n,q] (n) y
1. Configure the cluster in secure mode without FIPS
2. Configure the cluster in secure mode with FIPS
3. Back to previous menu
Select the option you would like to perform [1-2,b,q] (1) 2
```

- 2 To verify the cluster is in secure mode after configuration, run the command:

```
# haclus -<value> SecureClus
```

The command returns 1 if cluster is in secure mode, else returns 0.

Setting up trust relationships for your SF Oracle RAC cluster

If you need to use an external authentication broker for authenticating VCS users, you must set up a trust relationship between VCS and the broker. For example, if Veritas Operations Manager (VOM) is your external authentication broker, the trust relationship ensures that VCS accepts the credentials that VOM issues.

Perform the following steps to set up a trust relationship between your SF Oracle RAC cluster and a broker.

To set up a trust relationship

- 1 Ensure that you are logged in as superuser on one of the nodes in the cluster.
- 2 Enter the following command:

```
# /opt/VRTS/install/installsfrc<version> -securitytrust
```

Where <version> is the specific release version.

See [“About the Veritas installer”](#) on page 77.

The installer specifies the location of the log files. It then lists the cluster information such as cluster name, cluster ID, node names, and service groups.

- 3 When the installer prompts you for the broker information, specify the IP address, port number, and the data directory for which you want to establish trust relationship with the broker.

Input the broker name of IP address: **15.193.97.204**

Input the broker port: (14545)

Specify a port number on which broker is running or press Enter to accept the default port.

Input the data directory to setup trust with: (/var/VRTSvcs/vcsauth/data/HAD)

Specify a valid data directory or press Enter to accept the default directory.

- 4 The installer performs one of the following actions:
 - If you specified a valid directory, the installer prompts for a confirmation.

```
Are you sure that you want to setup trust for the VCS cluster
with the broker 15.193.97.204 and port 14545? [y,n,q] y
```

The installer sets up trust relationship with the broker for all nodes in the cluster and displays a confirmation.

```
Setup trust with broker 15.193.97.204 on cluster node1
.....Done
```

```
Setup trust with broker 15.193.97.204 on cluster node2
.....Done
```

The installer specifies the location of the log files, summary file, and response file and exits.

- If you entered incorrect details for broker IP address, port number, or directory name, the installer displays an error. It specifies the location of the log files, summary file, and response file and exits.

Configuring a secure cluster node by node

For environments that do not support passwordless ssh or passwordless remsh, you cannot use the `-security` option to enable secure mode for your cluster. Instead, you can use the `-securityonnode` option to configure a secure cluster node by node. Moreover, to enable security in fips mode, use the `-fips` option together with `-securityonnode`.

[Table 7-1](#) lists the tasks that you must perform to configure a secure cluster.

Table 7-1 Configuring a secure cluster node by node

Task	Reference
Configure security on one node	See "Configuring the first node" on page 95.
Configure security on the remaining nodes	See "Configuring the remaining nodes" on page 96.
Complete the manual configuration steps	See "Completing the secure cluster configuration" on page 97.

Configuring the first node

Perform the following steps on one node in your cluster.

To configure security on the first node

- 1 Ensure that you are logged in as superuser.
- 2 Enter the following command:

```
# /opt/VRTS/install/installsfrac<version> -securityonnode
```

Where *<version>* is the specific release version.

See [“About the Veritas installer”](#) on page 77.

The installer lists information about the cluster, nodes, and service groups. If VCS is not configured or if VCS is not running on all nodes of the cluster, the installer prompts whether you want to continue configuring security. It then prompts you for the node that you want to configure.

```
VCS is not running on all systems in this cluster. All VCS systems
must be in RUNNING state. Do you want to continue? [y,n,q] (n) y
```

```
1) Perform security configuration on first node and export
security configuration files.
```

```
2) Perform security configuration on remaining nodes with
security configuration files.
```

```
Select the option you would like to perform [1-2,q,?] 1
```

Warning: All VCS configurations about cluster users are deleted when you configure the first node. You can use the `/opt/VRTSvcs/bin/hauser` command to create cluster users manually.

- 3 The installer completes the secure configuration on the node. It specifies the location of the security configuration files and prompts you to copy these files to the other nodes in the cluster. The installer also specifies the location of log files, summary file, and response file.
- 4 Copy the security configuration files from the location specified by the installer to temporary directories on the other nodes in the cluster.

Configuring the remaining nodes

On each of the remaining nodes in the cluster, perform the following steps.

To configure security on each remaining node

- 1 Ensure that you are logged in as superuser.
- 2 Enter the following command:

```
# /opt/VRTS/install/installsfrac<version> -securityonnode
```

Where *<version>* is the specific release version.

See [“About the Veritas installer”](#) on page 77.

The installer lists information about the cluster, nodes, and service groups. If VCS is not configured or if VCS is not running on all nodes of the cluster, the installer prompts whether you want to continue configuring security. It then prompts you for the node that you want to configure. Enter **2**.

```
VCS is not running on all systems in this cluster. All VCS systems
must be in RUNNING state. Do you want to continue? [y,n,q] (n) y
```

```
1) Perform security configuration on first node and export
security configuration files.
```

```
2) Perform security configuration on remaining nodes with
security configuration files.
```

```
Select the option you would like to perform [1-2,q.?] 2
```

The installer completes the secure configuration on the node. It specifies the location of log files, summary file, and response file.

Completing the secure cluster configuration

Perform the following manual steps to complete the configuration.

To complete the secure cluster configuration

- 1 On the first node, freeze all service groups except the ClusterService service group.

```
# /opt/VRTSvcs/bin/haconf -makerw
```

```
# /opt/VRTSvcs/bin/hagrp -list Frozen=0
```

```
# /opt/VRTSvcs/bin/hagrp -freeze groupname -persistent
```

```
# /opt/VRTSvcs/bin/haconf -dump -makero
```

- 2 On the first node, stop the VCS engine.

```
# /opt/VRTSvcs/bin/hastop -all -force
```

- 3 On all nodes, stop the CmdServer.

```
# /opt/VRTSvcs/bin/CmdServer -stop
```

- 4 On the first node, edit the `/etc/VRTSvcs/conf/config/main.cf` file to resemble the following:

```
cluster clus1 (
  SecureClus = 1
)
```

- 5 On all nodes, create the `/etc/VRTSvcs/conf/config/.secure` file.

```
# touch /etc/VRTSvcs/conf/config/.secure
```

- 6 On the first node, start VCS. Then start VCS on the remaining nodes.

```
# /opt/VRTSvcs/bin/hastart
```

- 7 On all nodes, start CmdServer.

```
# /opt/VRTSvcs/bin/CmdServer
```

- 8 On the first node, unfreeze the service groups.

```
# /opt/VRTSvcs/bin/haconf -makerw
```

```
# /opt/VRTSvcs/bin/hagrp -list Frozen=1
```

```
# /opt/VRTSvcs/bin/hagrp -unfreeze groupname -persistent
```

```
# /opt/VRTSvcs/bin/haconf -dump -makero
```

Adding VCS users

If you have enabled a secure VCS cluster, you do not need to add VCS users now. Otherwise, on systems operating under an English locale, you can add VCS users at this time.

To add VCS users

1 Review the required information to add VCS users.

2 Reset the password for the Admin user, if necessary.

```
Do you wish to accept the default cluster credentials of
'admin/password'? [y,n,q] (y) n
Enter the user name: [b,q,?] (admin)
Enter the password:
Enter again:
```

3 To add a user, enter **y** at the prompt.

```
Do you want to add another user to the cluster? [y,n,q] (y)
```

4 Enter the user's name, password, and level of privileges.

```
Enter the user name: [b,q,?] smith
Enter New Password:*****

Enter Again:*****
Enter the privilege for user smith (A=Administrator, O=Operator,
G=Guest): [b,q,?] a
```

5 Enter **n** at the prompt if you have finished adding users.

```
Would you like to add another user? [y,n,q] (n)
```

6 Review the summary of the newly added users and confirm the information.

Configuring SMTP email notification

You can choose to configure VCS to send event notifications to SMTP email services. You need to provide the SMTP server name and email addresses of people to be notified. Note that you can also configure the notification after installation.

Refer to the *Veritas Cluster Server Administrator's Guide* for more information.

To configure SMTP email notification

- 1 Review the required information to configure the SMTP email notification.
- 2 Specify whether you want to configure the SMTP notification.

```
Do you want to configure SMTP notification? [y,n,q,?] (n) y
```

If you do not want to configure the SMTP notification, you can skip to the next configuration option.

See [“Configuring SNMP trap notification”](#) on page 101.

- 3 Provide information to configure SMTP notification.

Provide the following information:

- Enter the NIC information.

```
Active NIC devices discovered on sys1: lan0
Enter the NIC for the VCS Notifier to use on sys1:
[b,q,?] (lan0)
Is lan0 to be the public NIC used by all systems?
[y,n,q,b,?] (y)
```

- Enter the SMTP server's host name.

```
Enter the domain-based hostname of the SMTP server
(example: smtp.yourcompany.com): [b,q,?] smtp.example.com
```

- Enter the email address of each recipient.

```
Enter the full email address of the SMTP recipient
(example: user@yourcompany.com): [b,q,?] ozzie@example.com
```

- Enter the minimum security level of messages to be sent to each recipient.

```
Enter the minimum severity of events for which mail should be
sent to ozzie@example.com [I=Information, W=Warning,
E=Error, S=SevereError]: [b,q,?] w
```

- 4 Add more SMTP recipients, if necessary.

- If you want to add another SMTP recipient, enter **y** and provide the required information at the prompt.

```
Would you like to add another SMTP recipient? [y,n,q,b] (n) y
```

```
Enter the full email address of the SMTP recipient
```

```
(example: user@yourcompany.com): [b,q,?] harriet@example.com
```

```
Enter the minimum severity of events for which mail should be
sent to harriet@example.com [I=Information, W=Warning,
E=Error, S=SevereError]: [b,q,?] E
```

- If you do not want to add, answer **n**.

```
Would you like to add another SMTP recipient? [y,n,q,b] (n)
```

5 Verify and confirm the SMTP notification information.

```
NIC: lan0
```

```
SMTP Address: smtp.example.com
```

```
Recipient: ozzie@example.com receives email for Warning or
higher events
```

```
Recipient: harriet@example.com receives email for Error or
higher events
```

```
Is this information correct? [y,n,q] (y)
```

Configuring SNMP trap notification

You can choose to configure VCS to send event notifications to SNMP management consoles. You need to provide the SNMP management console name to be notified and message severity levels.

Note that you can also configure the notification after installation.

Refer to the *Veritas Cluster Server Administrator's Guide* for more information.

To configure the SNMP trap notification

- 1 Review the required information to configure the SNMP notification feature of VCS.
- 2 Specify whether you want to configure the SNMP notification.

```
Do you want to configure SNMP notification? [y,n,q,?] (n) y
```

If you skip this option and if you had installed a valid HA/DR license, the installer presents you with an option to configure this cluster as global cluster. If you did not install an HA/DR license, the installer proceeds to configure SF Oracle RAC based on the configuration details you provided.

See [“Configuring global clusters”](#) on page 103.

3 Provide information to configure SNMP trap notification.

Provide the following information:

- Enter the NIC information.

```
Active NIC devices discovered on sys1: lan0
Enter the NIC for the VCS Notifier to use on sys1:
[b,q,?] (lan0)
Is lan0 to be the public NIC used by all systems?
[y,n,q,b,?] (y)
```

- Enter the SNMP trap daemon port.

```
Enter the SNMP trap daemon port: [b,q,?] (162)
```

- Enter the SNMP console system name.

```
Enter the SNMP console system name: [b,q,?] sys5
```

- Enter the minimum security level of messages to be sent to each console.

```
Enter the minimum severity of events for which SNMP traps
should be sent to sys5 [I=Information, W=Warning, E=Error,
S=SevereError]: [b,q,?] E
```

4 Add more SNMP consoles, if necessary.

- If you want to add another SNMP console, enter `y` and provide the required information at the prompt.

```
Would you like to add another SNMP console? [y,n,q,b] (n) y
Enter the SNMP console system name: [b,q,?] sys4
Enter the minimum severity of events for which SNMP traps
should be sent to sys4 [I=Information, W=Warning,
E=Error, S=SevereError]: [b,q,?] S
```

- If you do not want to add, answer `n`.

Would you like to add another SNMP console? [y,n,q,b] (n)

5 Verify and confirm the SNMP notification information.

NIC: lan0

SNMP Port: 162

Console: sys5 receives SNMP traps for Error or higher events

Console: sys4 receives SNMP traps for SevereError or higher events

Is this information correct? [y,n,q] (y)

Configuring global clusters

If you had installed a valid HA/DR license, the installer provides you an option to configure this cluster as global cluster. If not, the installer proceeds with other set of questions for CVM and CFS.

You can configure global clusters to link clusters at separate locations and enable wide-area failover and disaster recovery. The installer adds basic global cluster information to the VCS configuration file. You must perform additional configuration tasks to set up a global cluster.

See the *Veritas Cluster Server Administrator's Guide* for instructions to set up SF Oracle RAC global clusters.

Note: If you installed a HA/DR license to set up campus cluster, skip this installer option.

To configure the global cluster option

- 1 Review the required information to configure the global cluster option.
- 2 Specify whether you want to configure the global cluster option.

Do you want to configure the Global Cluster Option? [y,n,q] (n) **y**

If you skip this option, the installer proceeds to configure VCS based on the configuration details you provided.

3 Provide information to configure this cluster as global cluster.

The installer prompts you for a NIC, a virtual IP address, value for the netmask, and value for the network hosts.

If you had entered virtual IP address details, the installer discovers the values you entered. You can use the same virtual IP address for global cluster configuration or enter different values.

4 Verify and confirm the configuration of the global cluster.

```
Global Cluster Option configuration verification:
```

```
NIC: lan0
IP: 192.168.1.16
Netmask: 255.255.240.0

NetworkHosts: 192.168.1.15

Is this information correct? [y,n,q] (y)
```

For complete details for configuring your disaster recovery environment once clusters are installed and configured:

See the *Veritas Storage Foundation and High Availability Solutions Disaster Recovery Implementation Guide*.

Creation of SF Oracle RAC configuration files

The program consolidates all the information gathered in the preceding configuration tasks and creates configuration files.

If you chose to configure the cluster in secure mode, the installer also configures the Symantec Product Authentication Service, which creates an Authentication Broker with root and authentication mode.

Review the output as the configuration program starts VCS, creates VCS configuration files, and copies the files to each node.

Stopping and starting SF Oracle RAC processes

The installer stops and starts SF Oracle RAC processes and configures the SF Oracle RAC agents.

Note: To use aggregated interfaces that the installer has not discovered for private heartbeats, do not opt to start SF Oracle RAC.

To stop SF Oracle RAC processes

- 1 Enter `y` to stop SF Oracle RAC processes.

```
Do you want to stop SF Oracle RAC processes now? [y,n,q,?] (y)
```

- 2 Review the output as the installer stops and starts the SF Oracle RAC processes.

Note that SF Oracle RAC configuration program starts I/O fencing feature in disabled mode. SF Oracle RAC requires you to configure and enable I/O fencing feature.

Setting up disk-based I/O fencing using `installsfrac`

You can configure I/O fencing using the `-fencing` option of the `installsfrac`.

Initializing disks as VxVM disks

Perform the following procedure to initialize disks as VxVM disks.

To initialize disks as VxVM disks

- 1 List the new external disks or the LUNs as recognized by the operating system. On each node, enter:

```
# ioscand -nfc disk
# insf -e
```

Warning: The HP-UX man page for the `insf` command instructs you to run the command in single-user mode only. You can run `insf -e` in multiuser mode only when no other user accesses any of the device files. This command can change the mode, owner, or group of an existing special (device) file, or unlink and recreate a file. The special files that are currently open may be left in an indeterminate state.

- 2 To initialize the disks as VxVM disks, use one of the following methods:
 - Use the interactive `vxdiskadm` utility to initialize the disks as VxVM disks.

For more information see the *Veritas Storage Foundation Administrator's Guide*.

- Use the `vxdisksetup` command to initialize a disk as a VxVM disk.

```
# vxdisksetup -i device_name
```

The example specifies the CDS format:

```
# vxdisksetup -i c2t13d0
```

Repeat this command for each disk you intend to use as a coordinator disk.

Identifying disks to use as coordinator disks

Make sure you initialized disks as VxVM disks.

See [“Initializing disks as VxVM disks”](#) on page 105.

Review the following procedure to identify disks to use as coordinator disks.

To identify the coordinator disks

- 1 List the disks on each node.

For example, execute the following commands to list the disks:

```
# vxdisk -o alldgs list
```

- 2 Pick three SCSI-3 PR compliant shared disks as coordinator disks.

See [“Checking shared disks for I/O fencing”](#) on page 106.

Checking shared disks for I/O fencing

Make sure that the shared storage you set up while preparing to configure SF Oracle RAC meets the I/O fencing requirements. You can test the shared disks using the `vxfcntlshdw` utility. The two nodes must have `ssh` (default) or `remsh` communication. To confirm whether a disk (or LUN) supports SCSI-3 persistent reservations, two nodes must simultaneously have access to the same disks. Because a shared disk is likely to have a different name on each node, check the serial number to verify the identity of the disk. Use the `vxfenadm` command with the `-i` option. This command option verifies that the same serial number for the LUN is returned on all paths to the LUN.

Make sure to test the disks that serve as coordinator disks.

The `vxfsthdw` utility has additional options suitable for testing many disks. Review the options for testing the disk groups (`-g`) and the disks that are listed in a file (`-f`). You can also test disks without destroying data using the `-r` option.

See the *Veritas Storage Foundation for Oracle RAC Administrator's Guide*.

Checking that disks support SCSI-3 involves the following tasks:

- Verifying the Array Support Library (ASL)
See [“Verifying Array Support Library \(ASL\)”](#) on page 107.
- Verifying that nodes have access to the same disk
See [“Verifying that the nodes have access to the same disk”](#) on page 109.
- Testing the shared disks for SCSI-3
See [“Testing the disks using vxfsthdw utility”](#) on page 109.

Verifying Array Support Library (ASL)

Make sure that the Array Support Library (ASL) for the array that you add is installed.

To verify Array Support Library (ASL)

- 1 If the Array Support Library (ASL) for the array that you add is not installed, obtain and install it on each node before proceeding.

The ASL for the supported storage device that you add is available from the disk array vendor or Symantec technical support.

- 2 Verify that the ASL for the disk array is installed on each of the nodes. Run the following command on each node and examine the output to verify the installation of ASL.

The following output is a sample:

```
# vxddladm listsupport all
```

LIBNAME	VID	PID
libvx3par.sl	3PARdata	VV
libvxCLARiiON.sl	DGC	All
libvxFJTSYe6k.sl	FUJITSU	E6000
libvxFJTSYe8k.sl	FUJITSU	All
libvxautoraid.sl	HP	C3586A, C5447A, A5257A
libvxcompellent.sl	COMPELNT	Compellent Vol
libvxcopan.sl	COPANSYS	8814, 8818
libvxdds2a.sl	DDN	S2A 9550, S2A 9900, S2A 9700
libvxdothill.sl	DotHill	R/Evo 2730-2R, R/Evo 2530-2R, R/Evo 2330-2R, R/Evo 2130-2RX, R/Evo 2130-2J, R/Evo 5730-2R
libvxemc.sl	EMC	SYMMETRIX
libvxelogic.sl	EQLOGIC	100E-00
libvxfc60.sl	HP	A5277A
libvxfje3k4ka.sl	FUJITSU	E3000, E400A
libvxfjtsye2k.sl	FUJITSU	E2000, ETERNUS_DXL

- 3 Scan all disk drives and their attributes, update the VxVM device list, and reconfigure DMP with the new devices. Type:

```
# vxdisk scandisks
```

See the Veritas Volume Manager documentation for details on how to add and configure disks.

Verifying that the nodes have access to the same disk

Before you test the disks that you plan to use as shared data storage or as coordinator disks using the `vxfcntlsthdw` utility, you must verify that the systems see the same disk.

To verify that the nodes have access to the same disk

- 1 Verify the connection of the shared storage for data to two of the nodes on which you installed SF Oracle RAC.
- 2 Ensure that both nodes are connected to the same disk during the testing. Use the `vxfenadm` command to verify the disk serial number.

```
# vxfenadm -i diskpath
```

Refer to the `vxfenadm` (1M) manual page.

For example, an EMC disk is accessible by the `/dev/vx/rmp/c1t1d0` path on node A and the `/dev/vx/rmp/c2t1d0` path on node B.

From node A, enter:

```
# vxfenadm -i /dev/vx/rmp/c1t1d0
```

```
Vendor id : EMC  
Product id : SYMMETRIX  
Revision : 5567  
Serial Number : 42031000a
```

The same serial number information should appear when you enter the equivalent command on node B using the `/dev/vx/rmp/c2t1d0` path.

On a disk from another manufacturer, Hitachi Data Systems, the output is different and may resemble:

```
# vxfenadm -i /dev/vx/rmp/c3t1d0
```

```
Vendor id      : HITACHI  
Product id    : OPEN-3      -HP  
Revision      : 0117  
Serial Number : 0401EB6F0002
```

Testing the disks using `vxfcntlsthdw` utility

This procedure uses the `/dev/vx/rmp/c1t1d0` disk in the steps.

If the utility does not show a message that states a disk is ready, the verification has failed. Failure of verification can be the result of an improperly configured disk array. The failure can also be due to a bad disk.

If the failure is due to a bad disk, remove and replace it. The `vxfcntlshdw` utility indicates a disk can be used for I/O fencing with a message resembling:

```
The disk /dev/vx/rdmp/ctl1d0 is ready to be configured for I/O Fencing on
node sys1
```

For more information on how to replace coordinator disks, refer to the *Veritas Storage Foundation for Oracle RAC Administrator's Guide*.

To test the disks using `vxfcntlshdw` utility

- 1 Make sure system-to-system communication functions properly.

See [“Setting up inter-system communication”](#) on page 583.

- 2 From one node, start the utility.

Run the utility with the `-n` option if you use `remsh` for communication.

```
# vxfcntlshdw [-n]
```

- 3 The script warns that the tests overwrite data on the disks. After you review the overview and the warning, confirm to continue the process and enter the node names.

Warning: The tests overwrite and destroy data on the disks unless you use the `-r` option.

```
***** WARNING!!!!!!!!!! *****
```

```
THIS UTILITY WILL DESTROY THE DATA ON THE DISK!!
```

```
Do you still want to continue : [y/n] (default: n) y
```

```
Enter the first node of the cluster: sys1
```

```
Enter the second node of the cluster: sys2
```

- 4 Enter the names of the disks that you want to check. Each node may know the same disk by a different name:

If the serial numbers of the disks are not identical, then the test terminates.

- 5 Review the output as the utility performs the checks and reports its activities.

- 6 If a disk is ready for I/O fencing on each node, the utility reports success for each node. For example, the utility displays the following message for the node `sys1`.

```
The disk is now ready to be configured for I/O Fencing on node
sys1
```

```
ALL tests on the disk /dev/vx/rmdp/clt1d0 have PASSED
The disk is now ready to be configured for I/O Fencing on node
sys1
```

- 7 Run the `vxfcntlsthdw` utility for each disk you intend to verify.

Configuring disk-based I/O fencing using `installsfrac`

Note: The installer stops and starts SF Oracle RAC to complete I/O fencing configuration. Make sure to unfreeze any frozen VCS service groups in the cluster for the installer to successfully stop SF Oracle RAC.

To set up disk-based I/O fencing using the `installsfrac`

- 1 Start the `installsfrac` with `-fencing` option.

```
# /opt/VRTS/install/installsfrac<version> -fencing
```

Where `<version>` is the specific release version.

See [“About the Veritas installer”](#) on page 77.

The `installsfrac` starts with a copyright message and verifies the cluster information.

Note the location of log files which you can access in the event of any problem with the configuration process.

- 2 Confirm that you want to proceed with the I/O fencing configuration at the prompt.

The program checks that the local node running the script can communicate with remote nodes and checks whether SF Oracle RAC 6.0.1 is configured properly.
- 3 Review the I/O fencing configuration options that the program presents. Type **2** to configure disk-based I/O fencing.

```
Select the fencing mechanism to be configured in this
Application Cluster [1-4,b,q] 2
```

- 4 Review the output as the configuration program checks whether VxVM is already started and is running.
 - If the check fails, configure and enable VxVM before you repeat this procedure.
 - If the check passes, then the program prompts you for the coordinator disk group information.

- 5 Choose whether to use an existing disk group or create a new disk group to configure as the coordinator disk group.

The program lists the available disk group names and provides an option to create a new disk group. Perform one of the following:

- To use an existing disk group, enter the number corresponding to the disk group at the prompt.
 The program verifies whether the disk group you chose has an odd number of disks and that the disk group has a minimum of three disks.
- To create a new disk group, perform the following steps:

- Enter the number corresponding to the **Create a new disk group** option.
 The program lists the available disks that are in the CDS disk format in the cluster and asks you to choose an odd number of disks with at least three disks to be used as coordinator disks.
 Symantec recommends that you use three disks as coordination points for disk-based I/O fencing.
 If the available VxVM CDS disks are less than the required, installer asks whether you want to initialize more disks as VxVM disks. Choose the disks you want to initialize as VxVM disks and then use them to create new disk group.
- Enter the numbers corresponding to the disks that you want to use as coordinator disks.
- Enter the disk group name.

- 6 Verify that the coordinator disks you chose meet the I/O fencing requirements.
 You must verify that the disks are SCSI-3 PR compatible using the `vxfsntsthdw` utility and then return to this configuration program.

See [“Checking shared disks for I/O fencing”](#) on page 106.

- 7 After you confirm the requirements, the program creates the coordinator disk group with the information you provided.

The program also does the following:

- Populates the `/etc/vxfendg` file with this disk group information

- Populates the `/etc/vxfenmode` file on each cluster node with the I/O fencing mode information and with the SCSI-3 disk policy information
- 8 Verify and confirm the I/O fencing configuration information that the installer summarizes.
- 9 Review the output as the configuration program does the following:
 - Stops VCS and I/O fencing on each node.
 - Configures disk-based I/O fencing and starts the I/O fencing process.
 - Updates the VCS configuration file `main.cf` if necessary.
 - Copies the `/etc/vxfenmode` file to a date and time suffixed file `/etc/vxfenmode-date-time`. This backup file is useful if any future fencing configuration fails.
 - Updates the I/O fencing configuration file `/etc/vxfenmode`.
 - Starts VCS on each node to make sure that the SF Oracle RAC is cleanly configured to use the I/O fencing feature.
- 10 Review the output as the configuration program displays the location of the log files, the summary files, and the response files.
- 11 Configure the Coordination Point Agent.

```
Do you want to configure Coordination Point Agent on
the client cluster? [y,n,q] (y)
```

- 12 Enter a name for the service group for the Coordination Point Agent.

```
Enter a non-existing name for the service group for
Coordination Point Agent: [b] (vxfen) vxfen
```

- 13 Set the level two monitor frequency.

```
Do you want to set LevelTwoMonitorFreq? [y,n,q] (y)
```

- 14 Decide the value of the level two monitor frequency.

```
Enter the value of the LevelTwoMonitorFreq attribute: [b,q,?] (5)
```

Installer adds Coordination Point Agent and updates the main configuration file.

Setting up server-based I/O fencing using installsfrac

You can configure server-based I/O fencing for the SF Oracle RAC cluster using the installsfrac.

With server-based fencing, you can have the coordination points in your configuration as follows:

- Combination of CP servers and SCSI-3 compliant coordinator disks
- CP servers only

See [“About planning to configure I/O fencing”](#) on page 58.

See [“Recommended CP server configurations”](#) on page 61.

This section covers the following example procedures:

Mix of CP servers and coordinator disks

See [“To configure server-based fencing for the SF Oracle RAC cluster \(one CP server and two coordinator disks\)”](#) on page 114.

To configure server-based fencing for the SF Oracle RAC cluster (one CP server and two coordinator disks)

- 1 Depending on the server-based configuration model in your setup, make sure of the following:
 - CP servers are configured and are reachable from the SF Oracle RAC cluster. The SF Oracle RAC cluster is also referred to as the application cluster or the client cluster.
 - The coordination disks are verified for SCSI3-PR compliance.
 See [“Checking shared disks for I/O fencing”](#) on page 106.
- 2 Start the installsfrac with the `-fencing` option.

```
# /opt/VRTS/install/installsfrac<version> -fencing
```

Where <version> is the specific release version. The installsfrac starts with a copyright message and verifies the cluster information.

See [“About the Veritas installer”](#) on page 77.

Note the location of log files which you can access in the event of any problem with the configuration process.

- 3 Confirm that you want to proceed with the I/O fencing configuration at the prompt.

The program checks that the local node running the script can communicate with remote nodes and checks whether SF Oracle RAC 6.0.1 is configured properly.

- 4 Review the I/O fencing configuration options that the program presents. Type **1** to configure server-based I/O fencing.

```
Select the fencing mechanism to be configured in this
Application Cluster [1-4,b,q] 1
```

- 5 Make sure that the storage supports SCSI3-PR, and answer **y** at the following prompt.

```
Does your storage environment support SCSI3 PR? [y,n,q] (y)
```

- 6 Provide the following details about the coordination points at the installer prompt:

- Enter the total number of coordination points including both servers and disks. This number should be at least 3.

```
Enter the total number of co-ordination points including both
Coordination Point servers and disks: [b] (3)
```

- Enter the total number of coordinator disks among the coordination points.

```
Enter the total number of disks among these:
[b] (0) 2
```

- 7 Provide the following CP server details at the installer prompt:

- Enter the total number of virtual IP addresses or the total number of fully qualified host names for each of the CP servers.

```
Enter the total number of Virtual IP addresses or fully
qualified host name for the
Coordination Point Server #1: [b,q,?] (1) 2
```

- Enter the virtual IP addresses or the fully qualified host name for each of the CP servers. The installer assumes these values to be identical as viewed from all the application cluster nodes.

```
Enter the Virtual IP address or fully qualified host name
#1 for the Coordination Point Server #1:
[b] 10.209.80.197
```

The installer prompts for this information for the number of virtual IP addresses you want to configure for each CP server.

- Enter the port that the CP server would be listening on.

```
Enter the port in the range [49152, 65535] which the
Coordination Point Server 10.209.80.197
would be listening on or simply accept the default port suggested:
[b] (14250)
```

8 Provide the following coordinator disks-related details at the installer prompt:

- Choose the coordinator disks from the list of available disks that the installer displays. Ensure that the disk you choose is available from all the SF Oracle RAC (application cluster) nodes.

The number of times that the installer asks you to choose the disks depends on the information that you provided in step 6. For example, if you had chosen to configure two coordinator disks, the installer asks you to choose the first disk and then the second disk:

```
Select disk number 1 for co-ordination point
```

- ```
1) c1t1d0
2) c2t1d0
3) c3t1d0
```

```
Please enter a valid disk which is available from all the
cluster nodes for co-ordination point [1-3,q] 1
```

- If you have not already checked the disks for SCSI-3 PR compliance in step 1, check the disks now.  
 The installer displays a message that recommends you to verify the disks in another window and then return to this configuration procedure.  
 Press Enter to continue, and confirm your disk selection at the installer prompt.
- Enter a disk group name for the coordinator disks or accept the default.

```
Enter the disk group name for coordinating disk(s):
[b] (vxfencoordg)
```

**9** Verify and confirm the coordination points information for the fencing configuration.

For example:

```
Total number of coordination points being used: 3
Coordination Point Server ([VIP or FQHN]:Port):
 1. 10.109.80.197 ([10.109.80.197]:14250)
SCSI-3 disks:
 1. c1t1d0
 2. c2t1d0
Disk Group name for the disks in customized fencing: vxfencoorddg
Disk policy used for customized fencing: raw
```

The installer initializes the disks and the disk group and depots the disk group on the SF Oracle RAC (application cluster) node.

**10** If the CP server is configured for security, the installer sets up secure communication between the CP server and the SF Oracle RAC (application cluster).

After the installer establishes trust between the authentication brokers of the CP servers and the application cluster nodes, press Enter to continue.

**11** Verify and confirm the I/O fencing configuration information.

```
CPS Admin utility location: /opt/VRTScps/bin/cpsadm
Cluster ID: 2122
Cluster Name: clus1
UUID for the above cluster: {ae5e589a-1dd1-11b2-dd44-00144f79240c}
```

- 12** Review the output as the installer updates the application cluster information on each of the CP servers to ensure connectivity between them. The installer then populates the `/etc/vxfenmode` file with the appropriate details in each of the application cluster nodes.

```
Updating client cluster information on Coordination Point Server 10.210.80.197

Adding the client cluster to the Coordination Point Server 10.210.80.197 Done

Registering client node sys1 with Coordination Point Server 10.210.80.197..... Done
Adding CPClient user for communicating to Coordination Point Server 10.210.80.197 Done
Adding cluster clus1 to the CPClient user on Coordination Point Server 10.210.80.197 .. Done

Registering client node sys2 with Coordination Point Server 10.210.80.197 Done
Adding CPClient user for communicating to Coordination Point Server 10.210.80.197 Done
Adding cluster clus1 to the CPClient user on Coordination Point Server 10.210.80.197 ..Done

Updating /etc/vxfenmode file on sys1 Done
Updating /etc/vxfenmode file on sys2 Done
```

See [“About I/O fencing configuration files”](#) on page 555.

- 13** Review the output as the installer stops and restarts the VCS and the fencing processes on each application cluster node, and completes the I/O fencing configuration.
- 14** Configure the CP agent on the SF Oracle RAC (application cluster). The Coordination Point Agent monitors the registrations on the coordination points.

```
Do you want to configure Coordination Point Agent on
the client cluster? [y,n,q] (y)
```

```
Enter a non-existing name for the service group for
Coordination Point Agent: [b] (vxfen)
```

- 15** Additionally the coordination point agent can also monitor changes to the Coordinator Disk Group constitution such as a disk being accidentally deleted from the Coordinator Disk Group. The frequency of this detailed monitoring can be tuned with the `LevelTwoMonitorFreq` attribute. For example, if you set this attribute to 5, the agent will monitor the Coordinator Disk Group constitution every five monitor cycles.

Note that for the `LevelTwoMonitorFreq` attribute to be applicable there must be disks as part of the Coordinator Disk Group.

```
Enter the value of the LevelTwoMonitorFreq attribute: (5)
```

```
Adding Coordination Point Agent via sys1 Done
```

- 16** Note the location of the configuration log files, summary files, and response files that the installer displays for later use.

# Installation of SF Oracle RAC using the Web-based installer

- [Chapter 8. Installing SF Oracle RAC](#)
- [Chapter 9. Configuring SF Oracle RAC](#)



# Installing SF Oracle RAC

This chapter includes the following topics:

- [Before using the Veritas Web-based installer](#)
- [Starting the Veritas Web-based installer](#)
- [Installing products with the Veritas Web-based installer](#)

## Before using the Veritas Web-based installer

The Veritas Web-based installer requires the following configuration.

**Table 8-1** Web-based installer requirements

| System                | Function                                                                                                        | Requirements                                                                                                                                                    |
|-----------------------|-----------------------------------------------------------------------------------------------------------------|-----------------------------------------------------------------------------------------------------------------------------------------------------------------|
| Target system         | The systems where you plan to install the Veritas products.                                                     | Must be a supported platform for SF Oracle RAC 6.0.1.                                                                                                           |
| Installation server   | The server where you start the installation. The installation media is accessible from the installation server. | Must use the same operating system as the target systems and must be at one of the supported operating system update levels.                                    |
| Administrative system | The system where you run the Web browser to perform the installation.                                           | Must have a Web browser.<br>Supported browsers: <ul style="list-style-type: none"><li>■ Internet Explorer 6, 7, and 8</li><li>■ Firefox 3.x and later</li></ul> |

## Starting the Veritas Web-based installer

This section describes starting the Veritas Web-based installer.

### To start the Web-based installer

- 1 Start the Veritas XPortal Server process `xprt1wid`, on the installation server:

```
./webinstaller start
```

The webinstaller script displays a URL. Note this URL.

---

**Note:** If you do not see the URL, run the command again.

The default listening port is 14172. If you have a firewall that blocks port 14172, use the `-port` option to use a free port instead.

---

- 2 On the administrative server, start the Web browser.
- 3 Navigate to the URL that the script displayed.
- 4 Certain browsers may display the following message:

```
Secure Connection Failed
```

Obtain a security exception for your browser.

When prompted, enter `root` and root's password of the installation server.

- 5 Log in as superuser.

## Installing products with the Veritas Web-based installer

This section describes installing SF Oracle RAC with the Veritas Web-based installer.

### To install SF Oracle RAC

- 1 Start the Web-based installer.  
See [“Starting the Veritas Web-based installer”](#) on page 122.
- 2 On the Select a task and product page, select the installation from the **Task** drop-down list.
- 3 Select **Veritas Storage Foundation for Oracle RAC** from the Product drop-down list, and click Next.

- 4 On the License agreement page, select whether you accept the terms of the End User License Agreement (EULA). To continue, select **Yes, I agree** and click **Next**.
- 5 Choose minimal, recommended, or all packages. Click **Next**.
- 6 Indicate the systems on which to install. Enter one or more system names, separated by spaces. Click **Next**.
- 7 After the validation completes successfully, click **Next** to install SF Oracle RAC on the selected system.
- 8 After the installation completes, you must choose your licensing method.  
On the license page, select one of the following tabs:

- Keyless licensing

---

**Note:** The keyless license option enables you to install without entering a key. However, in order to ensure compliance you must manage the systems with a management server.

For more information, go to the following website:

<http://go.symantec.com/sfhakeyless>

---

Complete the following information:

Choose whether you want to enable Global Cluster option.

Click Register.

- Enter license key  
If you have a valid license key, select this tab. Enter the license key for each system. Click **Register**.

- 9 The installer prompts you to configure the cluster. Select Yes to continue with configuring the product.

For instructions, see the chapter, "Preparing to Configure SF Oracle RAC."

If you select No, you can exit the installer. You must configure the product before you can use SF Oracle RAC.

After the installation completes, the installer displays the location of the log and summary files. If required, view the files to confirm the installation status.

If the installer prompts you to reboot the systems, do so.

- 10 Select the checkbox to specify whether you want to send your installation information to Symantec.

Would you like to send the information about this installation to Symantec to help improve installation in the future?

Click **Finish**. The installer prompts you for another task.

# Configuring SF Oracle RAC

This chapter includes the following topics:

- [Configuring SF Oracle RAC using the Web-based installer](#)
- [Configuring SF Oracle RAC for data integrity using the Web-based installer](#)

## Configuring SF Oracle RAC using the Web-based installer

Before you begin to configure SF Oracle RAC using the Web-based installer, review the configuration requirements.

By default, the communication between the systems is selected as SSH. If SSH is used for communication between systems, the SSH commands execute without prompting for passwords or confirmations.

You can click **Quit** to quit the Web-installer at any time during the configuration process.

### To configure SF Oracle RAC on a cluster

- 1 Start the Web-based installer.

See [“Starting the Veritas Web-based installer”](#) on page 122.

- 2 On the Select a task and a product page, select the task and the product as follows:

**Task**                      Configure a Product

**Product**                    Veritas Storage Foundation for Oracle RAC

Click **Next**.

- 3 On the Select Systems page, enter the system names where you want to configure SF Oracle RAC, and click **Next**.

Example: **sys1 sys2**

The installer performs the initial system verification. It checks for the system communication. It also checks for release compatibility, installed product version, platform version, and performs product prechecks.

Click **Next** after the installer completes the system verification successfully.

- 4 In the Confirmation dialog box that appears, choose whether or not to configure I/O fencing.

To configure I/O fencing, click **Yes**.

To configure I/O fencing later, click **No**. You can configure I/O fencing later using the Web-based installer.

See [“Configuring SF Oracle RAC for data integrity using the Web-based installer”](#) on page 130.

You can also configure I/O fencing later using the `installsfrac<version>-fencing` command, the response files, or manually configure.

Where `<version>` is the specific release version.

See [“About the Veritas installer”](#) on page 77.

5 On the Set Cluster Name/ID page, specify the following information for the cluster.

- |                                              |                                                                                                                                                                                                                                                                 |
|----------------------------------------------|-----------------------------------------------------------------------------------------------------------------------------------------------------------------------------------------------------------------------------------------------------------------|
| <b>Cluster Name</b>                          | Enter a unique cluster name.                                                                                                                                                                                                                                    |
| <b>Cluster ID</b>                            | Enter a unique cluster ID.<br><br>Note that you can have the installer check to see if the cluster ID is unique. Symantec recommends that you use the installer to check for duplicate cluster IDs in multi-cluster environments.                               |
| <b>Check duplicate cluster ID</b>            | Select the check box if you want the installer to verify if the given cluster ID is unique in your private network. The verification is performed after you specify the heartbeat details in the following pages. The verification takes some time to complete. |
| <b>LLT Type</b>                              | Select an LLT type from the list. You can choose to configure LLT over UDP or over Ethernet.                                                                                                                                                                    |
| <b>Number of Heartbeats</b>                  | Choose the number of heartbeat links you want to configure.                                                                                                                                                                                                     |
| <b>Additional Low Priority Heartbeat NIC</b> | Select the check box if you want to configure a low priority link. The installer configures one heartbeat link as low priority link.                                                                                                                            |
| <b>Unique Heartbeat NICs per system</b>      | For LLT over Ethernet, select the check box if you do not want to use the same NIC details to configure private heartbeat links on other systems.<br><br>For LLT over UDP, this check box is selected by default.                                               |

Click **Next**.

6 On the Set Cluster Heartbeat page, select the heartbeat link details for the LLT type you chose on the Set Cluster Name/ID page.

For **LLT over Ethernet**: Do the following:

- If you are using the same NICs on all the systems, select the NIC for each private heartbeat link.
- If you had selected **Unique Heartbeat NICs per system** on the Set Cluster Name/ID page, provide the NIC details for each system.

For **LLT over UDP**: Select the NIC, Port, and IP address for each private heartbeat link. You must provide these details for each system.

Click **Next**.

- 7 On the Optional Configuration page, decide the optional VCS features that you want to configure. Click the corresponding tab to specify the details for each option:

**Security**

To configure a secure SF Oracle RAC cluster, select the **Configure secure cluster** check box.

If you want to perform this task later, do not select the **Configure secure cluster** check box. You can use the `-security` option of the `installsrac`.

**Virtual IP**

- Select the **Configure Virtual IP** check box.
- If each system uses a separate NIC, select the **Configure NICs for every system separately** check box.
- Select the interface on which you want to configure the virtual IP.
- Enter a virtual IP address and value for the netmask. Enter the value for the networkhosts.

**VCS Users**

- Reset the password for the Admin user, if necessary.
- Select the **Configure VCS users** option.
- Click **Add** to add a new user.  
Specify the user name, password, and user privileges for this user.

**SMTP**

- Select the **Configure SMTP** check box.
- If each system uses a separate NIC, select the **Configure NICs for every system separately** check box.
- If all the systems use the same NIC, select the NIC for the VCS Notifier to be used on all systems. If not, select the NIC to be used by each system.
- In the **SMTP Server** box, enter the domain-based hostname of the SMTP server. Example: `smtp.yourcompany.com`
- In the **Recipient** box, enter the full email address of the SMTP recipient. Example: `user@yourcompany.com`.
- In the **Event** list box, select the minimum security level of messages to be sent to each recipient.
- Click **Add** to add more SMTP recipients, if necessary.



**SNMP**

- Select the **Configure SNMP** check box.
- If each system uses a separate NIC, select the **Configure NICs for every system separately** check box.
- If all the systems use the same NIC, select the NIC for the VCS Notifier to be used on all systems. If not, select the NIC to be used by each system.
- In the **SNMP Port** box, enter the SNMP trap daemon port: (162).
- In the **Console System Name** box, enter the SNMP console system name.
- In the **Event** list box, select the minimum security level of messages to be sent to each console.
- Click **Add** to add more SNMP consoles, if necessary.

**GCO**

If you installed a valid HA/DR license, you can now enter the wide-area heartbeat link details for the global cluster that you would set up later.

See the *Veritas Storage Foundation for Oracle RAC Installation and Configuration Guide* for instructions to set up SF Oracle RAC global clusters.

- Select the **Configure GCO** check box.
- If each system uses a separate NIC, select the **Configure NICs for every system separately** check box.
- Select a NIC.
- Enter a virtual IP address and value for the netmask. Enter the value for the networkhosts.

Click **Next**.

- 8 On the NetworkHosts Configuration page, enter the details of the network hosts and click **Next**.
- 9 On the Stop Processes page, click **Next** after the installer stops all the processes successfully.
- 10 On the Start Processes page, click **Next** after the installer performs the configuration based on the details you provided and starts all the processes successfully.

If you did not choose to configure I/O fencing in step 4, then skip to step 12. Go to step 11 to configure fencing.

- 11 On the Select Fencing Type page, choose the type of fencing configuration:

**Configure Coordination Point client based fencing** Choose this option to configure server-based I/O fencing.

**Configure disk based fencing** Choose this option to configure disk-based I/O fencing.

Based on the fencing type you choose to configure, follow the installer prompts.

See [“Configuring SF Oracle RAC for data integrity using the Web-based installer”](#) on page 130.

- 12 Click **Next** to complete the process of configuring SF Oracle RAC.

On the Completion page, view the summary file, log file, or response file, if needed, to confirm the configuration.

- 13 Select the checkbox to specify whether you want to send your installation information to Symantec.

Click **Finish**. The installer prompts you for another task.

## Configuring SF Oracle RAC for data integrity using the Web-based installer

After you configure SF Oracle RAC, you must configure the cluster for data integrity. Review the configuration requirements.

See [“Configuring SF Oracle RAC using the Web-based installer”](#) on page 125.

See [“About planning to configure I/O fencing”](#) on page 58.

Ways to configure I/O fencing using the Web-based installer:

- See [“Configuring disk-based fencing for data integrity using the Web-based installer”](#) on page 130.
- See [“Configuring server-based fencing for data integrity using the Web-based installer”](#) on page 132.
- See [“Online fencing migration mode using the Web-based installer”](#) on page 134.

## Configuring disk-based fencing for data integrity using the Web-based installer

After you configure SF Oracle RAC, you must configure the cluster for data integrity. Review the configuration requirements.

See “[Configuring SF Oracle RAC using the Web-based installer](#)” on page 125.

See “[About planning to configure I/O fencing](#)” on page 58.

**To configure SF Oracle RAC for data integrity**

- 1 Start the Web-based installer.

See “[Starting the Veritas Web-based installer](#)” on page 122.

- 2 On the Select a task and a product page, select the task and the product as follows:

|                |                                           |
|----------------|-------------------------------------------|
| <b>Task</b>    | I/O fencing configuration                 |
| <b>Product</b> | Veritas Storage Foundation for Oracle RAC |

Click **Next**.

- 3 Verify the cluster information that the installer presents and confirm whether you want to configure I/O fencing on the cluster.
- 4 On the Select Cluster page, click **Next** if the installer completes the cluster verification successfully.

The installer performs the initial system verification. It checks for the system communication. It also checks for release compatibility, installed product version, platform version, and performs product prechecks.

- 5 On the Select Fencing Type page, select the `Configure disk-based fencing` option.
- 6 On the Configure Fencing page, the installer prompts for details based on the fencing type you chose to configure. Specify the coordination points details.

Click **Next**.

- 7 On the Configure Fencing page, specify the following information:

- |                            |                                                                                                                                                                                                                                                                                                                                                                                                                                                                                             |
|----------------------------|---------------------------------------------------------------------------------------------------------------------------------------------------------------------------------------------------------------------------------------------------------------------------------------------------------------------------------------------------------------------------------------------------------------------------------------------------------------------------------------------|
| <b>Select a Disk Group</b> | <p>Select the <b>Create a new disk group</b> option or select one of the disk groups from the list.</p> <ul style="list-style-type: none"> <li>■ If you selected one of the disk groups that is listed, the default fencing disk policy for the disk group is <code>dmp</code>.</li> <li>■ If you selected the <b>Create a new disk group</b> option, make sure you have SCSI-3 PR enabled disks, and click <b>Yes</b> in the confirmation dialog box.</li> </ul> <p>Click <b>Next</b>.</p> |
|----------------------------|---------------------------------------------------------------------------------------------------------------------------------------------------------------------------------------------------------------------------------------------------------------------------------------------------------------------------------------------------------------------------------------------------------------------------------------------------------------------------------------------|

8 On the Create New DG page, specify the following information:

**New Disk Group Name** Enter a name for the new coordinator disk group you want to create.

**Select Disks** Select at least three disks to create the coordinator disk group.  
  
If you want to select more than three disks, make sure to select an odd number of disks.

**Fencing Disk Policy** The default fencing disk policy for the disk group is dmp.

9 If you want to configure the Coordination Point agent on the client cluster, do the following:

- At the prompt for configuring the Coordination Point agent on the client cluster, click **Yes** and enter the Coordination Point agent service group name.
- If you want to set the LevelTwoMonitorFreq attribute, click Yes at the prompt and enter a value (0 to 65535).
- Follow the rest of the prompts to complete the Coordination Point agent configuration.

10 Click **Next** to complete the process of configuring I/O fencing.

On the Completion page, view the summary file, log file, or response file, if needed, to confirm the configuration.

11 Select the checkbox to specify whether you want to send your installation information to Symantec.

Click **Finish**. The installer prompts you for another task.

## Configuring server-based fencing for data integrity using the Web-based installer

After you configure SF Oracle RAC, you must configure the cluster for data integrity. Review the configuration requirements.

See [“Configuring SF Oracle RAC using the Web-based installer”](#) on page 125.

See [“About planning to configure I/O fencing”](#) on page 58.

**To configure SF Oracle RAC for data integrity**

- 1 Start the Web-based installer.  
See “Starting the Veritas Web-based installer” on page 122.
- 2 On the Select a task and a product page, select the task and the product as follows:

|                |                                           |
|----------------|-------------------------------------------|
| <b>Task</b>    | I/O fencing configuration                 |
| <b>Product</b> | Veritas Storage Foundation for Oracle RAC |

Click **Next**.

- 3 Verify the cluster information that the installer presents and confirm whether you want to configure I/O fencing on the cluster.
- 4 On the Select Cluster page, click **Next** if the installer completes the cluster verification successfully.  
  
The installer performs the initial system verification. It checks for the system communication. It also checks for release compatibility, installed product version, platform version, and performs product prechecks.
- 5 On the Select Fencing Type page, select the `Configure server-based fencing` option.
- 6 On the Configure Fencing page, the installer prompts for details based on the fencing type you chose to configure. Specify the coordination points details.  
Click **Next**.
- 7 Provide the following details for each of the CP servers:
  - Enter the virtual IP addresses or host names of the virtual IP address. The installer assumes these values to be identical as viewed from all the application cluster nodes.
  - Enter the port that the CP server must listen on.
  - Click **Next**.
- 8 If your server-based fencing configuration also uses disks as coordination points, perform the following steps:
  - If you have not already checked the disks for SCSI-3 PR compliance, check the disks now, and click OK in the dialog box.
  - If you do not want to use the default coordinator disk group name, enter a name for the new coordinator disk group you want to create.
  - Select the disks to create the coordinator disk group.

- Choose the fencing disk policy for the disk group.  
The default fencing disk policy for the disk group is dmp.
- 9 In the Confirmation dialog box that appears, confirm whether the coordination points information you provided is correct, and click **Yes**.
- 10 Verify and confirm the I/O fencing configuration information.  
The installer stops and restarts the VCS and the fencing processes on each application cluster node, and completes the I/O fencing configuration.
- 11 If you want to configure the Coordination Point agent on the client cluster, do the following:
  - At the prompt for configuring the Coordination Point agent on the client cluster, click **Yes** and enter the Coordination Point agent service group name.
  - Follow the rest of the prompts to complete the Coordination Point agent configuration.
- 12 Click **Next** to complete the process of configuring I/O fencing.  
On the Completion page, view the summary file, log file, or response file, if needed, to confirm the configuration.
- 13 Select the checkbox to specify whether you want to send your installation information to Symantec.  
  
Click **Finish**. The installer prompts you for another task.

## Online fencing migration mode using the Web-based installer

After you configure SF Oracle RAC, you must configure the cluster for data integrity. Review the configuration requirements.

See [“Configuring SF Oracle RAC using the Web-based installer”](#) on page 125.

See [“About planning to configure I/O fencing”](#) on page 58.

**To configure SF Oracle RAC for data integrity**

- 1 Start the Web-based installer.  
See [“Starting the Veritas Web-based installer”](#) on page 122.
- 2 On the Select a task and a product page, select the task and the product as follows:

|                |                                           |
|----------------|-------------------------------------------|
| <b>Task</b>    | I/O fencing configuration                 |
| <b>Product</b> | Veritas Storage Foundation for Oracle RAC |

Click **Next**.

- 3 Verify the cluster information that the installer presents and confirm whether you want to configure I/O fencing on the cluster.
- 4 On the Select Cluster page, click **Next** if the installer completes the cluster verification successfully.  
  
The installer performs the initial system verification. It checks for the system communication. It also checks for release compatibility, installed product version, platform version, and performs product prechecks.
- 5 Fencing may be enabled, installer may prompt whether you want to reconfigure it.  
  
Click **Yes**.
- 6 On the Select Fencing Type page, select the `Online fencing migration` option.
- 7 The installer prompts to select the coordination points you want to remove from the currently configured coordination points.  
  
Click **Next**.
- 8 Provide the number of Coordination point server and disk coordination points to be added to the configuration.  
  
Click **Next**.
- 9 Provide the number of virtual IP addresses or Fully Qualified Host Name (FQHN) used for each coordination point server.  
  
Click **Next**.
- 10 Provide the IP or FQHN and port number for each coordination point server.  
  
Click **Next**.

- 11 Installer prompts to confirm the online migration coordination point servers.

Click **Yes**.

---

**Note:** If the coordination point servers are configured in secure mode, then the communication between coordination point servers and client servers happen in secure mode.

---

- 12 Installer proceeds with migration of the new coordination point servers. VCS is restarted during configuration.

Click **Next**.

- 13 You can add a Coordination Point agent to the client cluster and also provide name to the agent.

- 14 Click **Next**.

- 15 On the Completion page, view the summary file, log file, or response file, if needed, to confirm the configuration.

- 16 Select the checkbox to specify whether you want to send your installation information to Symantec.

Click **Finish**. The installer prompts you for another task.



# Installation of SF Oracle RAC using operating system-specific methods

- [Chapter 10. Installing SF Oracle RAC](#)

# Installing SF Oracle RAC

This chapter includes the following topics:

- [Installing SF Oracle RAC using Ignite-UX](#)

## Installing SF Oracle RAC using Ignite-UX

You can install SF Oracle RAC or the HP-UX operating system and SF Oracle RAC using Ignite-UX.

The following procedures describe:

- See [“Creating the Software Distributor \(SD\) bundle for SF Oracle RAC or the operating system and SF Oracle RAC”](#) on page 138.
- See [“Using Ignite-UX to perform a standalone SF Oracle RAC installation”](#) on page 139.
- See [“Using Ignite-UX to install SF Oracle RAC and the HP-UX operating system”](#) on page 141.

## Creating the Software Distributor (SD) bundle for SF Oracle RAC or the operating system and SF Oracle RAC

You can use the installer to create SD bundles.

You must run the following commands from an Ignite-UX Server. The `-ignite` option cannot run with other installation options.

---

**Note:** When you create the SD bundle for SF Oracle RAC, the Veritas product disc must be mounted on the Ignite-UX Server.

---

### To create an SD bundle using the installer

- 1 Log in to a configured and running Ignite-UX Server and mount the Veritas installation disc.
- 2 From the prompt, run the **installer** command with the **-ignite** option.

```
installer -ignite
```

- 3 Select the product to create its SD bundle.
- 4 The installer prompts you for the directory name to place the bundle.

```
Enter the file directory to create the VCS bundle:
(/var/opt/ignite/depots)
Checking the free space of file system Done
Enter a name for the bundle which holds all the VCS depots:
(VCS601_bundle)
```

- 5 Accept the default bundle name or give the bundle a new name.
- 6 The installer copies the depots of the selected product from the disc to the Ignite-UX Server and creates the bundle. It then generates configuration files for the bundle.

- 7 The bundle is ready for a standalone installation of the specific product. To quit the installer choose the last option, **None of the above**.

Continue to the next step if you plan to create an SD bundle for both the operating system and SF Oracle RAC.

- 8 The installer checks the `/var/opt/ignite/data/INDEX` file to determine if the HP-UX operating system configuration files are available on the Ignite-UX Server. If the file is available, the installer prompts you to add the newly created bundle `cfg` into the HP-UX operating system `cfg` clause. You need to add it so that you can choose the bundle during the HP-UX operating system installation.

Answer **y** to add the bundle `cfg` into the HP-UX operating system `cfg` clause.

## Using Ignite-UX to perform a standalone SF Oracle RAC installation

You can use Ignite-UX to install SF Oracle RAC on a standalone system.

### To use Ignite-UX to install SF Oracle RAC

- 1 Make sure that the following OS native bundles or depots are removed before installation.
  - Operating system bundles:

- Base-VxTools-50
  - Base-VxVM-50
  - B3929FB
  - Base-VxFS-50
  - Base-VxVM
  - Base-VxTools-501
  - Base-VxVM-501
  - B3929GB
  - Base-VxFS-501
  - Operating system bundle depots:
    - AVXTOOL
    - AVXVM
    - AONLINEJFS
    - OnlineJFS01
    - AVXFS
- 2 Create the SD bundle. You should be able to install this bundle to HP-UX systems on your network.
- See [“Creating the Software Distributor \(SD\) bundle for SF Oracle RAC or the operating system and SF Oracle RAC”](#) on page 138.
- 3 On the system where you want to install the Veritas product, run the following command.
- ```
# swinstall -x autoreboot=true -x enforce_dependencies=false \  
-s ignite_server_ipadd:/var/opt/ignite/depots/  
product_bundle product_bundle
```
- Where *ignite_server_ipadd* is the IP address of the Ignite-UX Server and where */var/opt/ignite/depots* is the directory path.
- For example:
- ```
swinstall -x autoreboot=true -x enforce_dependencies=false \
-s 10.198.92.81:/var/opt/ignite/depots/SFRAC601_bundle SFRAC601_bundle
```
- 4 After you install the bundle, reboot the system.
- 5 Configure the product. See the configuration chapter of this guide.

## Using Ignite-UX to install SF Oracle RAC and the HP-UX operating system

You can use Ignite-UX to install SF Oracle RAC and the operating system.

### To use Ignite-UX to install SF Oracle RAC and the operating system

- 1 Create the SD bundle. You should be able to install this bundle to HP-UX systems on your network.  
  
See [“Creating the Software Distributor \(SD\) bundle for SF Oracle RAC or the operating system and SF Oracle RAC”](#) on page 138.
- 2 Install the operating system. See the appropriate HP-UX documentation for details.
- 3 If you use the Ignite-UX screen GUI, switch to the **Software** tab on the configuration page of the operating system installation. On the **Software** tab, select and enable the Veritas product bundle that you want to install.
- 4 On the **Software** tab, deselect any of the following operating system bundles if they are there and they are selected:
  - Base-VxTools-50
  - Base-VxVM-50
  - B3929FB
  - Base-VxFS-50
  - Base-VxVM
  - Base-VxTools-501
  - Base-VxVM-501
  - B3929GB
  - Base-VxFS-501
- 5 After you have installed the operating system, you need to configure the product. See the configuration chapter of this guide.

# 6

## Section

# Post-installation and configuration tasks

- [Chapter 11. Verifying the installation](#)
- [Chapter 12. Performing additional post-installation and configuration tasks](#)

# Verifying the installation

This chapter includes the following topics:

- [Performing a postcheck on a node](#)
- [Verifying SF Oracle RAC installation using VCS configuration file](#)
- [Verifying LLT, GAB, and cluster operation](#)

## Performing a postcheck on a node

The installer's `postcheck` command can help you to determine installation-related problems and provide troubleshooting information.

See [“About using the postcheck option”](#) on page 507.

**To run the postcheck command on a node**

- 1 Run the installer with the `-postcheck` option.

```
./installer -postcheck system_name
```

- 2 Review the output for installation-related information.

## Verifying SF Oracle RAC installation using VCS configuration file

The configuration file, `main.cf`, is created on each node at `/etc/VRTSvcs/conf/config/`. Review the `main.cf` configuration file after the SF Oracle RAC installation and before the Oracle installation.

Verify the following information in the `main.cf` file:

- The cluster definition within the main.cf includes the cluster information that was provided during the configuration. The cluster information includes the cluster name, cluster address, and the names of cluster users and administrators.
- The UseFence = SCSI3 attribute is present in the file.
- If you configured the cluster in secure mode, the “SecureClus = 1” cluster attribute is set.

For more information on the configuration file:

See [“About VCS configuration file”](#) on page 552.

## Verifying LLT, GAB, and cluster operation

Verify the operation of LLT, GAB, and the cluster using the VCS commands.

### To verify LLT, GAB, and cluster operation

- 1 Log in to any node in the cluster as superuser.
- 2 Make sure that the PATH environment variable is set to run the VCS commands.
- 3 Verify LLT operation.  
See [“Verifying LLT”](#) on page 144.
- 4 Verify GAB operation.  
See [“Verifying GAB”](#) on page 146.
- 5 Verify the cluster operation.  
See [“Verifying the cluster”](#) on page 148.

## Verifying LLT

Use the `lltstat` command to verify that links are active for LLT. If LLT is configured correctly, this command shows all the nodes in the cluster. The command also returns information about the links for LLT for the node on which you typed the command.

Refer to the `lltstat(1M)` manual page for more information.

### To verify LLT

- 1 Log in as superuser on the node `sys1`.
- 2 Run the `lltstat` command on the node `sys1` to view the status of LLT.

```
lltstat -n
```



The output on sys1 resembles:

```
LLT node information:
Node State Links
*0 sys1 OPEN 2
 1 sys2 OPEN 2
```

Each node has two links and each node is in the OPEN state. The asterisk (\*) denotes the node on which you typed the command.

If LLT does not operate, the command does not return any LLT links information: If only one network is connected, the command returns the following LLT statistics information:

```
LLT node information:
Node State Links
* 0 sys1 OPEN 2
 1 sys2 OPEN 2
 2 sys5 OPEN 1
```

- 3 Log in as superuser on the node sys2.
- 4 Run the `lltstat` command on the node sys2 to view the status of LLT.

```
lltstat -n
```

The output on sys2 resembles:

```
LLT node information:
Node State Links
 0 sys1 OPEN 2
*1 sys2 OPEN 2
```

- 5 To view additional information about LLT, run the `lltstat -nvv` command on each node.

For example, run the following command on the node sys1 in a two-node cluster:

```
lltstat -nvv active
```

The output on sys1 resembles:

```
Node State Link Status Address
*0 sys1 OPEN
 lan1 UP 08:00:20:93:0E:34
 lan2 UP 08:00:20:93:0E:38
```

```

1 sys2 OPEN

lan1 UP 08:00:20:8F:D1:F2
lan2 DOWN

```

The command reports the status on the two active nodes in the cluster, sys1 and sys2.

For each correctly configured node, the information must show the following:

- A state of OPEN
- A status for each link of UP
- An address for each link

However, the output in the example shows different details for the node sys2. The private network connection is possibly broken or the information in the `/etc/llttab` file may be incorrect.

- 6 To obtain information about the ports open for LLT, type `lltstat -p` on any node.

For example, type `lltstat -p` on the node sys1 in a two-node cluster:

```
lltstat -p
```

The output resembles:

```

LLT port information:
Port Usage Cookie
0 gab 0x0
 opens: 0 2 3 4 5 6 7 8 9 10 11 ... 60 61 62 63
 connects: 0 1
7 gab 0x7
 opens: 0 2 3 4 5 6 7 8 9 10 11 ... 60 61 62 63
 connects: 0 1
31 gab 0x1F
 opens: 0 2 3 4 5 6 7 8 9 10 11 ... 60 61 62 63
 connects: 0 1

```

## Verifying GAB

Verify the GAB operation using the `gabconfig -a` command. This command returns the GAB port membership information. The output displays the nodes that have membership with the modules you installed and configured. You can use GAB port membership as a method of determining if a specific component of the SF Oracle RAC stack communicates with its peers.

Table 11-1 lists the different ports that the software configures for different functions.

**Table 11-1** GAB port description

| Port | Function                                                                                                                                                                                                                                                                 |
|------|--------------------------------------------------------------------------------------------------------------------------------------------------------------------------------------------------------------------------------------------------------------------------|
| a    | GAB                                                                                                                                                                                                                                                                      |
| b    | I/O fencing                                                                                                                                                                                                                                                              |
| d    | Oracle Disk Manager (ODM)                                                                                                                                                                                                                                                |
| f    | Cluster File System (CFS)                                                                                                                                                                                                                                                |
| h    | Veritas Cluster Server (VCS: High Availability Daemon)                                                                                                                                                                                                                   |
| o    | VCSMM driver                                                                                                                                                                                                                                                             |
| u    | Cluster Volume Manager (CVM)<br>(to ship commands from slave node to master node)<br><br>Port u in the <code>gabconfig</code> output is visible with CVM protocol version $\geq 100$ . Run the <code>vxctl protocolversion</code> command to check the protocol version. |
| v    | Cluster Volume Manager (CVM)                                                                                                                                                                                                                                             |
| w    | vxconfigd (module for CVM)                                                                                                                                                                                                                                               |
| y    | Cluster Volume Manager (CVM) I/O shipping                                                                                                                                                                                                                                |

For more information on GAB, refer to the *Veritas Cluster Server Administrator's Guide*.

### To verify GAB

- ◆ To verify the GAB operation, type the following command on each node:

```
/sbin/gabconfig -a
```

For example, the command returns the following output:

```
GAB Port Memberships
```

```
=====
Port a gen ada401 membership 01
Port b gen ada40d membership 01
Port d gen ada409 membership 01
Port f gen ada41c membership 01
Port h gen ada40f membership 01
Port o gen ada406 membership 01
Port u gen ada41a membership 01
Port v gen ada416 membership 01
Port w gen ada418 membership 01
Port y gen ada42a membership 01
```

## Verifying the cluster

Verify the status of the cluster using the `hastatus` command. This command returns the system state and the group state.

Refer to the `hastatus(1M)` manual page.

Refer to the *Veritas Cluster Server Administrator's Guide* for a description of system states and the transitions between them.

## To verify the cluster

- 1 To verify the status of the cluster, type the following command:

```
hastatus -summary
```

The output resembles:

```
-- SYSTEM STATE
-- System State Frozen

A sys1 RUNNING 0
A sys2 RUNNING 0

-- GROUP STATE
-- Group System Probed AutoDisabled State

B cvm sys1 Y N ONLINE
B cvm sys2 Y N ONLINE
```

- 2 Review the command output for the following information:
  - The system state  
If the value of the system state is `RUNNING`, the cluster is successfully started.
  - The cvm group state  
In the sample output, the group state lists the cvm group, which is `ONLINE` on both the nodes `sys1` and `sys2`.

## Verifying the cluster nodes

Verify the information of the cluster systems using the `hasys -display` command. The information for each node in the output should be similar.

Refer to the `hasys(1M)` manual page.

Refer to the *Veritas Cluster Server Administrator's Guide* for information about the system attributes for VCS.

### To verify the cluster nodes

- ◆ On one of the nodes, type the `hasys -display` command:

```
hasys -display
```

The example shows the output when the command is run on the node `sys1`. The list continues with similar information for `sys2` (not shown) and any other nodes in the cluster.

| #System | Attribute          | Value                                                                                               |
|---------|--------------------|-----------------------------------------------------------------------------------------------------|
| sys1    | AgentsStopped      | 0                                                                                                   |
| sys1    | AvailableCapacity  | 100                                                                                                 |
| sys1    | CPUBinding         | BindTo None CPUNumber 0                                                                             |
| sys1    | CPUThresholdLevel  | Critical 90 Warning 80 Note 70<br>Info 60                                                           |
| sys1    | CPUUsage           | 0                                                                                                   |
| sys1    | CPUUsageMonitoring | Enabled 0 ActionThreshold 0<br>ActionTimeLimit 0 Action NONE<br>NotifyThreshold 0 NotifyTimeLimit 0 |
| sys1    | Capacity           | 100                                                                                                 |
| sys1    | ConfigBlockCount   | 141                                                                                                 |
| sys1    | ConfigChecksum     | 33975                                                                                               |
| sys1    | ConfigDiskState    | CURRENT                                                                                             |
| sys1    | ConfigFile         | /etc/VRTSvcs/conf/config                                                                            |
| sys1    | ConfigInfoCnt      | 0                                                                                                   |
| sys1    | ConfigModDate      | Mon Sep 03 07:14:23 CDT 2012                                                                        |
| sys1    | ConnectorState     | Up                                                                                                  |
| sys1    | CurrentLimits      |                                                                                                     |
| sys1    | DiskHbStatus       |                                                                                                     |
| sys1    | DynamicLoad        | 0                                                                                                   |
| sys1    | EngineRestarted    | 0                                                                                                   |
| sys1    | EngineVersion      | 6.0.10.0                                                                                            |
| sys1    | FencingWeight      | 0                                                                                                   |
| sys1    | Frozen             | 0                                                                                                   |
| sys1    | GUIIPAddr          |                                                                                                     |
| sys1    | HostUtilization    | CPU 0 Swap 0                                                                                        |

```

sys1 LLTNodeId 0
sys1 LicenseType PERMANENT_SITE
sys1 Limits
sys1 LinkHbStatus lan1 UP lan2 UP
sys1 LoadTimeCounter 0
sys1 LoadTimeThreshold 600
sys1 LoadWarningLevel 80
sys1 NoAutoDisable 0
sys1 NodeId 0
sys1 OnGrpCnt 7
sys1 PhysicalServer
sys1 ShutdownTimeout 600
sys1 SourceFile ./main.cf
sys1 SwapThresholdLevel Critical 90 Warning 80 Note 70
Info 60
sys1 SysInfo HP-UX:sys1,U,B.11.31,ia64
sys1 SysName sys1
sys1 SysState RUNNING
sys1 SystemLocation
sys1 SystemOwner
sys1 SystemRecipients
sys1 TFrozen 0
sys1 TRSE 0
sys1 UpDownState Up
sys1 UserInt 0
sys1 UserStr
sys1 VCSFeatures DR

```

sys1

VCSMode

VCS\_RAC



# Performing additional post-installation and configuration tasks

This chapter includes the following topics:

- [About enabling LDAP authentication for clusters that run in secure mode](#)
- [About configuring authentication for SFDB tools](#)
- [Configuring Veritas Volume Replicator](#)
- [Running SORT Data Collector to collect configuration information](#)

## About enabling LDAP authentication for clusters that run in secure mode

Symantec Product Authentication Service (AT) supports LDAP (Lightweight Directory Access Protocol) user authentication through a plug-in for the authentication broker. AT supports all common LDAP distributions such as OpenLDAP and Windows Active Directory.

For a cluster that runs in secure mode, you must enable the LDAP authentication plug-in if the VCS users belong to an LDAP domain.

See the *Veritas Cluster Server Installation Guide* for more information.

## About configuring authentication for SFDB tools

To configure authentication for Storage Foundation for Databases (SFDB) tools, perform the following tasks:

Configure the `vxdbd` daemon to require authentication

See [“Configuring vxdbd for SFDB tools authentication”](#) on page 154.

Add a node to a cluster that is using authentication for SFDB tools

See [“Adding nodes to a cluster that is using authentication for SFDB tools”](#) on page 459.

## Configuring vxdbd for SFDB tools authentication

To configure `vxdbd`, perform the following steps as the root user

- 1 Run the `sfae_auth_op` command to set up the authentication services.

```
/opt/VRTS/bin/sfae_auth_op -o setup
Setting up AT
Starting SFAE AT broker
Creating SFAE private domain
Backing up AT configuration
Creating principal for vxdbd
```

- 2 Stop the `vxdbd` daemon.

```
/opt/VRTS/bin/vxdbdctrl stop
Stopping Veritas vxdbd
vxdbd stop succeeded
```

- 3 Enable authentication by setting the `AUTHENTICATION` key to `yes` in the `/etc/vx/vxdbed/admin.properties` configuration file.

```
If /etc/vx/vxdbed/admin.properties does not exist, then use cp
/opt/VRTSdbed/bin/admin.properties.example
/etc/vx/vxdbed/admin.properties.
```

- 4 Start the `vxdbd` daemon.

```
/opt/VRTS/bin/vxdbdctrl start
Starting Veritas vxdbd
/opt/VRTSdbed/bin/vxdbd start SUCCESS
```

The `vxdbd` daemon is now configured to require authentication.

# Configuring Veritas Volume Replicator

Perform this step only if you have not already configured VVR during the installation.

By default, the installer installs the required VVR configuration files irrespective of whether or not you choose to enable VVR. To configure VVR manually in SF Oracle RAC, simply start VVR using the `vxstart_vvr` command. The command starts the VVR daemons and configures the ports. You may change the default settings at any time.

For instructions on changing the default settings, see the *Veritas Volume Replicator Administrator's Guide*.

## To configure VVR

- 1 Log into each node in the cluster as the root user.
- 2 Start VVR:

```
vxstart_vvr start
VxVM VVR INFO V-5-2-3935 Using following ports:
heartbeat: 4145
vradmind: 8199
vxrsyncd: 8989
data: Anonymous-Ports
To change, see vrport(1M) command
VxVM VVR V-5-2-5942 Starting Communication daemon: [OK]
```

# Running SORT Data Collector to collect configuration information

SORT Data Collector now supersedes the VRTExplorer utility. Run the Data Collector with the `VxExplorer` option to gather information about the system.

Visit the SORT Website and download the UNIX Data Collector appropriate for your operating system.

<https://sort.symantec.com>

For more information:

<https://sort.symantec.com/public/help/wwhelp/wwhimpl/js/html/wwhelp.htm>

# Upgrade of SF Oracle RAC

- Chapter 13. Planning to upgrade SF Oracle RAC
- Chapter 14. Performing a full upgrade of SF Oracle RAC using the product installer
- Chapter 15. Performing an automated full upgrade of SF Oracle RAC using response files
- Chapter 16. Performing a phased upgrade of SF Oracle RAC
- Chapter 17. Performing a rolling upgrade of SF Oracle RAC
- Chapter 18. Upgrading from Storage Foundation High Availability products to SF Oracle RAC 6.0.1
- Chapter 19. Migrating from single instance Storage Foundation for Oracle HA to SF Oracle RAC
- Chapter 20. Performing post-upgrade tasks

# Planning to upgrade SF Oracle RAC

This chapter includes the following topics:

- [About types of upgrade](#)
- [Supported upgrade paths](#)

## About types of upgrade

SF Oracle RAC supports various ways of upgrading your cluster to the latest version. Choose a method that best suits your environment and supports your planned upgrade path.

[Table 13-1](#) lists the supported types of upgrade.

**Table 13-1** Types of upgrade

| Type of upgrade | Method of upgrade                                                                                                                                                                                           | Procedures                                                                                                                                                                                                                                                                                                                                                                                                                           |
|-----------------|-------------------------------------------------------------------------------------------------------------------------------------------------------------------------------------------------------------|--------------------------------------------------------------------------------------------------------------------------------------------------------------------------------------------------------------------------------------------------------------------------------------------------------------------------------------------------------------------------------------------------------------------------------------|
| Full upgrade    | Veritas script-based installation programs <ul style="list-style-type: none"> <li>■ Interactive mode</li> <li>■ Non-interactive mode using response files</li> </ul> Veritas Web-based installation program | Complete the following steps: <ul style="list-style-type: none"> <li>■ Preparing to upgrade<br/>See <a href="#">“Preparing to perform a full upgrade to SF Oracle RAC 6.0.1”</a> on page 161.</li> <li>■ Upgrading to SF Oracle RAC 6.0.1<br/>See the chapter <i>Performing a full upgrade to SF Oracle RAC 6.0.1</i>.</li> <li>■ Completing post-upgrade tasks<br/>See the chapter <i>Performing post-upgrade tasks</i>.</li> </ul> |

**Table 13-1** Types of upgrade (*continued*)

| Type of upgrade | Method of upgrade                                                                                                                                                          | Procedures                                                                                     |
|-----------------|----------------------------------------------------------------------------------------------------------------------------------------------------------------------------|------------------------------------------------------------------------------------------------|
| Phased upgrade  | Combination of manual steps and the Veritas script-based installation programs<br><br><b>Note:</b> SF Oracle RAC does not support phased upgrades using the Web installer. | Complete the steps in the chapter <i>Performing a phased upgrade to SF Oracle RAC 6.0.1</i> .  |
| Rolling upgrade | Veritas script-based installation programs<br><br>Veritas Web-based installation program                                                                                   | Complete the steps in the chapter <i>Performing a rolling upgrade to SF Oracle RAC 6.0.1</i> . |

## Supported upgrade paths

SF Oracle RAC software must be at the same version across all nodes in an SF Oracle RAC cluster after the upgrade, that is 6.0.1.

Review the following information before you upgrade:

- If you are running an Oracle RAC version that is not supported in this release, first upgrade Oracle RAC to the supported version before upgrading SF Oracle RAC. For instructions, see the product documentation of the version in use.
- If you are running SF Oracle RAC version 3.5x, first upgrade to version 4.1 MP2 or 5.0 (11i Version 2), then upgrade to version 6.0.1.  
For instructions, see the *Veritas Storage Foundation for Oracle RAC Installation and Configuration Guide* of the corresponding version.
- The directory `/opt` must be writable and must not be a symbolic link. You can not have a symbolic link from `/opt` to an unconverted volume. If you do have a symbolic link to an unconverted volume, the symbolic link will not function during the upgrade and items in `/opt` will not be installed.

[Table 13-2](#) lists the supported upgrade paths.

**Table 13-2** Supported upgrade paths

| From SF Oracle RAC version                                                                                           | To SF Oracle RAC version | To OS version | Supported upgrade type  |
|----------------------------------------------------------------------------------------------------------------------|--------------------------|---------------|-------------------------|
| SF Oracle RAC 4.1 MP2 and later versions on HP-UX 11iv2 (including maintenance packs and rolling patches on 4.1 MP2) | 6.0.1                    | HP-UX 11iv3   | Full or phased upgrade  |
| SF Oracle RAC 5.0 and later versions on HP-UX 11iv2 (including maintenance packs and rolling patches on 5.0)         | 6.0.1                    | HP-UX 11iv3   | Full or phased upgrade  |
| SF Oracle RAC 5.0 and later versions on HP-UX 11iv3 (including maintenance packs and rolling patches on 5.0)         | 6.0.1                    | HP-UX 11iv3   | Full or phased upgrade  |
| SF Oracle RAC 5.0.1 and later versions on HP-UX 11iv3 (including maintenance packs and rolling patches on 5.0.1)     | 6.0.1                    | HP-UX 11iv3   | Full or phased upgrade  |
| SF Oracle RAC 5.1 SP1 and later versions on HP-UX 11iv3 (including maintenance packs and rolling patches on 5.1 SP1) | 6.0.1                    | HP-UX 11iv3   | Full or rolling upgrade |
| SF Oracle RAC 6.0 and later versions on HP-UX 11iv3 (including rolling patches on 6.0)                               | 6.0.1                    | HP-UX 11iv3   | Full or rolling upgrade |

# Performing a full upgrade of SF Oracle RAC using the product installer

This chapter includes the following topics:

- [About full upgrades](#)
- [Preparing to perform a full upgrade to SF Oracle RAC 6.0.1](#)
- [Pre-upgrade tasks for migrating the SFDB repository database](#)
- [Upgrading to SF Oracle RAC 6.0.1](#)

## About full upgrades

A full upgrade involves upgrading all the nodes in the cluster at the same time. All components are upgraded during the process. The cluster remains unavailable for the duration of the upgrade.

---

**Note:** You can not roll back the upgrade to a previous version after you upgrade to version 6.0.1.

---

You can perform the upgrade using one of the following Veritas script-based installation programs:

- Common product installer (`installer` or `webinstaller`)  
The common product installer provides menu options for installing and configuring multiple Veritas products.
- SF Oracle RAC installation programs (`installsfprac`)



The SF Oracle RAC installation programs provide menu options for installing and configuring SF Oracle RAC. You can use either the script-based installer or the Web-based installer.

---

**Note:** If you obtained SF Oracle RAC from an electronic download site, you must use the product installer (`installsfrac`) instead of the common product installer (`installer`).

---

You can also perform a full upgrade using a response file. You can create a response file by using the response file template or by customizing a response file that is generated by the script-based installer.

For more information about response files:

See [“About response files”](#) on page 353.

## Preparing to perform a full upgrade to SF Oracle RAC 6.0.1

Perform the preparatory steps in this section if you are performing a full upgrade of the cluster. Before you upgrade, make sure that your systems meet the hardware and software requirements for this release.

### To prepare to upgrade SF Oracle RAC

- 1 Log in as superuser to one of the nodes in the cluster.
- 2 Back up the following configuration files on your system: `main.cf`, `types.cf`, `CVMTTypes.cf`, `CFSTypes.cf`, `OracleTypes.cf`, `OracleASMTTypes.cf`, `PrivNIC.cf`, `MultiPrivNIC.cf`, `CRSResource.cf`, `/etc/llttab`, `/etc/llthosts`, `/etc/gabtab`, `/etc/vxfentab`, `/etc/vxfendg`, `/etc/vxfenmode`

For example:

```
cp /etc/VRTSvcs/conf/config/main.cf \
/etc/VRTSvcs/conf/config/main.cf.save
```

- 3 Installer verifies that recent backups of configuration files in VxVM private region have been saved in `/etc/vx/cbr/bk`.

If not, a warning message is displayed.

---

**Warning:** Backup `/etc/vx/cbr/bk` directory.

---

- 4 Stop all applications that use VxFS or VxVM disk groups, whether local or CFS.

If the applications are under VCS control:

```
hagrps -offline grp_name -any
```

If the applications are not under VCS control:

Use native application commands to stop the application.

- 5 For Oracle RAC 9i, log in as Oracle user on each node and stop `gsd`:

```
$ $ORACLE_HOME/bin/psctl stop
```

- 6 For Oracle RAC 10g and Oracle RAC 11g:

Stop all Oracle RAC resources.

- If the database instances are managed by VCS, take the corresponding VCS service groups offline. As superuser, enter:

```
hagrps -offline group_name -any
```

- If the database instances are not managed by VCS, then run the following on one node:

```
$ srvctl stop database -d db_name
```

- 7 ■ If the Oracle database is managed by VCS, set the `AutoStart` value to 0 to prevent the database service group from starting automatically when VCS starts:

```
haconf -makerw
```

```
hagrps -modify oracle_group AutoStart 0
```

```
haconf -dump -makero
```

- If the Oracle database is not managed by VCS, change the management policy for the database to manual:

```
$ srvctl modify database -d db_name -y manual
```

**8** Stop VCS on all nodes:

```
hastop -all
```

One way to check whether or not the configuration is valid is to check the main.cf file as follows:

```
hacf -verify /etc/VRTSvcs/conf/config
```

However, this method can not verify whether all configurations are valid. If SF Oracle RAC was running properly before the upgrade, the configurations are valid.

**9** Unmount the non-system mounts on the VxFS file system, which is not under VCS control.

```
mount -v |grep vxfs
```

```
umount /mount_point
```

Make sure that no processes are running which make use of mounted shared file system or shared volumes.

```
fuser -cu /mount_point
```

**10** If you plan to continue using the Storage Foundation for Databases (SFDB) tools, you must prepare to migrate the SFDB repository database before upgrading to SF Oracle RAC 6.0.1.

See [“Pre-upgrade tasks for migrating the SFDB repository database”](#) on page 165.

**11** If you plan to upgrade the operating system, stop all ports.

If you are running version 5.1 and later, stop the ports using the installer:

```
./installsfrac -stop
```

If you are running version 5.0.1x and earlier, stop the ports manually as follows:

```
vcsmmconfig -U
/sbin/init.d/odm stop
/sbin/init.d/vxfen stop
/sbin/gabconfig -U
kcmodule vxfen=unused
kcmodule odm=unused
kcmodule vcsmm=unused
kcmodule vxglm=unused
kcmodule vxgms=unused
lmxconfig -U
kcmodule lmx=unused
kcmodule gab=unused
lltconfig -U
kcmodule llt=unused
```

**12** Perform the following steps only if you are upgrading from HP-UX 11i v2:

- If the cluster-wide attribute “UseFence” is set to SCSI3, then reset the value to NONE in the /etc/VRTSvcs/conf/config/main.cf file.
- On each node, edit the /etc/vxfenmode file to configure I/O fencing in disabled mode.

```
cat /etc/vxfenmode
vxfen_mode=disabled
```

---

**Note:** If you upgrade from SF Oracle RAC 4.1 on HP-UX 11iv2, create /etc/vxfenmode file and populate it as above.

---

- On each node, change LLT\_START=0 in the file /etc/rc.config.d/lltconf.
- On each node, remove the following device files:

```
rm -f /dev/llt
rm -f /dev/gab*
rm -f /dev/vxfen
```

```
rm -f /dev/lmx
rm -f /dev/vcsmm
```

## Pre-upgrade tasks for migrating the SFDB repository database

If you plan to continue using Database Storage Checkpoints or SmartTier for Oracle policies you created with a 5.0x or earlier version of Storage Foundation for Oracle RAC, you must migrate the SFDB repository database to 6.0.1.

---

**Note:** The Sfua\_Base repository resource group will be removed from the main.cf file. It is not required as a separate service group for SF Oracle RAC 6.0.1.

---

Perform the following before upgrading SF Oracle RAC.

### To prepare to migrate the repository database

- ◆ Resynchronize all existing snapshots before upgrading. As Oracle user, enter:

```
$ /opt/VRTS/bin/dbed_vmsnap -S $ORACLE_SID \
-f SNAPPLAN -o resync
```

---

**Warning:** The Database Flashsnap clone database will not be able to be carried over after upgrading. You must create a new Database Flashsnap clone database after upgrading to 6.0.1.

---

## Upgrading to SF Oracle RAC 6.0.1

Perform the steps in the following procedure to upgrade to SF Oracle RAC 6.0.1.

### To upgrade to SF Oracle RAC 6.0.1

- 1 If you want to upgrade the operating system, perform the following steps:
  - Rename the `/etc/llttab` file to prevent LLT from starting automatically when the node starts:

```
mv /etc/llttab /etc/llttab.save
```
  - Upgrade the operating system on all nodes in the cluster. See [“Upgrading the HP-UX operating system”](#) on page 167.

- After the system restarts, restore the `/etc/llttab` file to its original name:

```
mv /etc/llttab.save /etc/llttab
```

- 2 Upgrade to SF Oracle RAC 6.0.1 using the script-based installer or the Web-based installer.

See [“Upgrading SF Oracle RAC using the Veritas script-based installation program”](#) on page 168.

See [“Upgrading Veritas Storage Foundation for Oracle RAC using the Veritas Web-based installer”](#) on page 171.

You can also perform a silent upgrade:

See [“Upgrading SF Oracle RAC using a response file”](#) on page 173.

- 3 Manually mount the VxFS and CFS file systems that are not managed by VCS and if they are not included in the `/etc/fstab` file.

- 4 Relink the SF Oracle RAC libraries with Oracle.

See [“Relinking Oracle RAC libraries with the SF Oracle RAC libraries”](#) on page 228.

- 5 Bring the Oracle database service group online.

- If the Oracle database is managed by VCS:

```
hagrps -online Oracle_group -any
```

- If the Oracle database is not managed by VCS:

```
srvctl start database -d db_name
```

- 6 Start all applications that are not managed by VCS. Use native application commands to start the applications.

- 7 ■ If the Oracle database is managed by VCS, reset the AutoStart value to 1 to enable VCS to bring the database service group online automatically when VCS starts:

```
haconf -makerw
hagrps -modify oradb_grpname AutoStart 1
haconf -dump -makero
```

- If the Oracle database is not managed by VCS, change the management policy for the database to automatic:

```
$ srvctl modify database -d db_name -y AUTOMATIC
```

**8** Complete other post-upgrade steps.

For instructions, see the chapter *Performing post-upgrade tasks* in this document.

- See “[Setting or changing the product license level](#)” on page 232.
- See “[Upgrading disk layout versions](#)” on page 232.
- See “[Upgrading CVM protocol version and VxVM disk group version](#)” on page 233.
- See “[Post upgrade tasks for migrating the SFDB repository database](#)” on page 234.

**9** For upgrade scenarios that involve Oracle RAC 9i, start `gsd` as the Oracle user:

```
$ $ORACLE_HOME/bin/gsdctl start
```

**10** Upgrade Oracle RAC, if required.

---

**Note:** Oracle RAC 11g Release 1 Clusterware is not supported. Make sure that you install Oracle RAC 11g Release 2 Grid Infrastructure in order to use the Oracle RAC 11g Release 1 database. All database versions starting from Oracle 10g Release 2 and later are supported.

---

For instructions, see the chapter *Upgrading Oracle RAC* in this document.

**11** If you want to upgrade CP server systems that use VCS or SFHA to 6.0.1, make sure that you upgraded all application clusters to version 6.0.1. Then, upgrade VCS or SFHA on the CP server systems.

For instructions to upgrade VCS or SFHA on the CP server systems, see the VCS or SFHA installation guide.

## Upgrading the HP-UX operating system

If you are on an unsupported version of the operating system, you need to upgrade it to HP-UX 11i v3 March 2011 or later.

If you are upgrading the operating system from HP-UX 11i v2, make sure that you choose the following depots along with the HP-UX 11i v3 March 2011 or later OEUR release depots:

- `Base-VxFS-version`  
 where *version* is the base VxFS version bundled with the operating system.
- `Base-VxTools-version`  
 where *version* is the base VxTools version bundled with the operating system.

- `Base-VxVM-version`

where *version* is the base VxVM version bundled with the operating system.

To upgrade the operating system from HP-UX 11i v2, run the `update-ux` command specifying the Veritas depots along with the HP-UX operating system depots:

```
swinstall -s os_path Update-UX
update-ux -s os_path HPUX11i-DC-OE \
Base-VxFS-version Base-VxTools-version \
Base-VxVM-version
```

where *os\_path* is the full path of the directory containing the operating system depots.

where *version* is the the base version of Veritas depots bundled with the operating system.

To upgrade the operating system from HP-UX 11i v3, run the `update-ux` command as follows:

```
update-ux -s os_path HPUX11i-DC-OE
```

where *os\_path* is the full path of the directory containing the operating system depots.

For detailed instructions on upgrading the operating system, see the operating system documentation.

## Upgrading SF Oracle RAC using the Veritas script-based installation program

Use the `installer` or the `installsfrac` Veritas script-based installation programs to upgrade SF Oracle RAC.

The installer performs the following tasks to upgrade SF Oracle RAC:

- Verifies the compatibility of the systems before the upgrade.
- Stops the SF Oracle RAC processes before the upgrade.
- Uninstalls SF Oracle RAC.
- Installs the SF Oracle RAC 6.0.1 depots on the nodes.
- Starts SF Oracle RAC 6.0.1 on all the nodes.
- Displays the location of the log files, summary file, and response file.



**To upgrade to SF Oracle RAC 6.0.1 using the installsfrac program**

**1 Start the installation program using one of the following ways:**

SF Oracle RAC installer      Navigate to the product directory on the installation media that contains the installation program.

The program is located in the `storage_foundation_for_oracle_rac` directory.

Run the program:

```
./installsfrac sys1 sys2
```

Common product installer      Navigate to the product directory on the installation media that contains the installation program.

Run the program:

```
./installer sys1 sys2
```

From the opening Selection Menu, choose **G** for "**Upgrade a Product.**"

Select the option **Full Upgrade.**"

The installer displays the copyright message and specifies the directory where the running logs are created.

The installer verifies the systems for compatibility.

---

**Note:** If `had` is stopped before upgrade, the installer displays the following warning:

VCS is not running before upgrade. Please make sure all the configurations are valid before upgrade.

If the configuration files are valid, you may ignore the message.

---

Review the messages displayed and make sure that you meet the requirements before proceeding with the upgrade.

**2 Press **Enter** to continue with the upgrade.**

Enter `y` to agree to the End User License Agreement (EULA).

The installer displays the list of depots that will be uninstalled. Press **Enter** to view the list of depots that will be upgraded.

**3 Enter y to stop the SF Oracle RAC processes.**

```
Do you want to stop SF Oracle RAC processes now? [y,n,q,?] (y)
```

The installer stops SF Oracle RAC processes and shuts down SF Oracle RAC on all nodes in the cluster. It uninstalls the existing SF Oracle RAC depots on the cluster and installs SF Oracle RAC 6.0.1 depots.

If you are upgrading from 5.0 releases that use regular license keys (not vxkeyless), then the installer shows the following warning. Select 'n' when prompted for additional licenses.

```
CPI WARNING V-9-40-5323 SFRAC license version 5.0 is not
updated to 6.0 on sys1. It's recommended to upgrade to a 6.0 key.
CPI WARNING V-9-40-5323 SFRAC license version 5.0 is not updated
to 6.0 on sys2. It's recommended to upgrade to a 6.0 key.
```

```
SFRAC is licensed on the systems
Do you wish to enter additional licenses? [y,n,q,b] (n) n
```

**4 Perform the following steps only if you upgraded from HP-UX 11i v2:**

- Reset the cluster-wide attribute “UseFence” to SCSI3 in the /etc/VRTSvcs/conf/config/main.cf file.
- If fencing was configured to use the "raw" mode, configure fencing to run in "dmp" mode:

```
cp /etc/vxfen.d/vxfenmode_scsi3_dmp /etc/vxfenmode
```

- Set the LLT\_START attribute to 1 in the /etc/rc.config.d/lltconf file:

```
LLT_START=1
```

**5 Restart each node in the cluster.**

```
/usr/sbin/shutdown -r now
```

**6 Complete the remaining tasks to finish the upgrade:**

See [“Upgrading to SF Oracle RAC 6.0.1”](#) on page 165.

## Upgrading Veritas Storage Foundation for Oracle RAC using the Veritas Web-based installer

This section describes upgrading SF Oracle RAC with the Veritas Web-based installer. The installer detects and upgrades the product that is currently installed on the specified system or systems.

### To upgrade SF Oracle RAC

- 1 Start the Web-based installer.

See [“Starting the Veritas Web-based installer”](#) on page 122.

- 2 Indicate the systems on which to upgrade. Enter one or more system names, separated by spaces. Click **Next**.
- 3 Click **Next** to complete the upgrade.

After the upgrade completes, the installer displays the location of the log and summary files. If required, view the files to confirm the installation status.

- 4 Perform the following steps only if you upgraded from HP-UX 11i v2:

- Reset the cluster-wide attribute “UseFence” to SCSI3 in the `/etc/VRTSvcs/conf/config/main.cf` file.
- If fencing was configured to use the “raw” mode, configure fencing to run in “dmp” mode:

```
cp /etc/vxfen.d/vxfenmode_scsi3_dmp /etc/vxfenmode
```

- Set the LLT\_START attribute to 1 in the `/etc/rc.config.d/lltconf` file:

```
LLT_START=1
```

- 5 If you are prompted to reboot the systems, enter the following reboot command:

```
/usr/sbin/shutdown -r now
```

- 6 If you want to upgrade VCS or SFHA 5.1 on the CP server systems to version SF Oracle RAC 6.0.1, make sure that you upgraded all application clusters to version SF Oracle RAC 6.0.1. Then, upgrade VCS or SFHA on the CP server systems. For instructions to upgrade VCS or SFHA, see the VCS or SFHA Installation Guide.

- 7 If you are prompted to reboot the systems, enter the following reboot command:

```
/usr/sbin/shutdown -r now
```

- 8 Complete the remaining tasks to finish the upgrade:  
See [“Upgrading to SF Oracle RAC 6.0.1”](#) on page 165.

# Performing an automated full upgrade of SF Oracle RAC using response files

This chapter includes the following topics:

- [Upgrading SF Oracle RAC using a response file](#)
- [Response file variables to upgrade Veritas Storage Foundation for Oracle RAC](#)
- [Sample response file for upgrading SF Oracle RAC](#)

## Upgrading SF Oracle RAC using a response file

You can upgrade from SF Oracle RAC version 4.1 MP2 and later using a response file.

Perform the steps in the following procedure to upgrade to SF Oracle RAC 6.0.1 using a response file.

### To upgrade SF Oracle RAC using a response file

- 1 Upgrade the operating system, if required.  
For instructions, see the operating system documentation.
- 2 Create a response file using one of the available options.

---

**Note:** Make sure that you replace the host names in the response file with the names of the systems that you plan to upgrade.

---

For information on various options available for creating a response file:

See [“About response files”](#) on page 353.

For response file variable definitions:

See [“Response file variables to upgrade Veritas Storage Foundation for Oracle RAC”](#) on page 174.

For a sample response file:

See [“Sample response file for upgrading SF Oracle RAC”](#) on page 175.

- 3 Navigate to the product directory on the installation media that contains the SF Oracle RAC installation program.
- 4 Start the installation:

```
./installsfrac -responsefile /tmp/response_file
```

Where `/tmp/response_file` is the full path name of the response file.

- 5 Restart the nodes in the cluster:

```
shutdown -r now
```

- 6 Complete the post-upgrade steps.  
See the chapter "Performing post-upgrade tasks" in this document.

## Response file variables to upgrade Veritas Storage Foundation for Oracle RAC

[Table 15-1](#) lists the response file variables that you can define to configure SF Oracle RAC.

**Table 15-1** Response file variables for upgrading SF Oracle RAC

| Variable          | Description                                                                                                                                                                                                                                 |
|-------------------|---------------------------------------------------------------------------------------------------------------------------------------------------------------------------------------------------------------------------------------------|
| CFG{accepteula}   | Specifies whether you agree with the EULA.pdf file on the media.<br><br>List or scalar: scalar<br><br>Optional or required: required                                                                                                        |
| CFG{systems}      | List of systems on which the product is to be installed or uninstalled.<br><br>List or scalar: list<br><br>Optional or required: required                                                                                                   |
| CFG{opt}{keyfile} | Defines the location of an ssh keyfile that is used to communicate with all remote systems.<br><br>List or scalar: scalar<br><br>Optional or required: optional                                                                             |
| CFG{opt}{tmppath} | Defines the location where a working directory is created to store temporary files and the depots that are needed during the install. The default location is /var/tmp.<br><br>List or scalar: scalar<br><br>Optional or required: optional |
| CFG{opt}{logpath} | Mentions the location where the log files are to be copied. The default location is /opt/VRTS/install/logs.<br><br>List or scalar: scalar<br><br>Optional or required: optional                                                             |

## Sample response file for upgrading SF Oracle RAC

The following sample response file upgrades SF Oracle RAC to version 6.0.1 on two nodes, sys1 and sys2.

```
our %CFG;

$CFG{accepteula}=1;
$CFG{opt}{upgrade}=1;
$CFG{systems}=[qw(sys1 sys2)];
$CFG{vcs_allowcomms}=1;
```

1;



# Performing a phased upgrade of SF Oracle RAC

This chapter includes the following topics:

- [About phased upgrade](#)
- [Performing phased upgrade of SF Oracle RAC from version 5.0 and later releases](#)

## About phased upgrade

The phased upgrade methodology involves upgrading half of the nodes in the cluster at a time.

For supported upgrade paths:

See [“Supported upgrade paths”](#) on page 158.

---

**Note:** You can perform a phased upgrade only if the Oracle RAC binaries are present on the local file system.

---

---

**Caution:** There is a potential for dependency problems between product components that no longer match when upgrading part of a cluster at a time. Follow the phased upgrade procedures carefully to avoid these problems.

---

**Note:** There will be some downtime involved. Review the procedures and carefully plan your downtime before proceeding with any steps. The sample procedures assume that Oracle RAC binaries are installed on local file systems for each node in the cluster.

Set up remote passwordless communication between the first sub-cluster nodes and the second sub-cluster nodes. For instructions, see the appendix *Setting up inter-system communication* in this document.

The examples in the procedures assume a four-node SF Oracle RAC cluster with the nodes *sys1* and *sys2* constituting the first half of the cluster and the nodes *sys3* and *sys4* constituting the second half of the cluster.

## Performing phased upgrade of SF Oracle RAC from version 5.0 and later releases

Table 16-1 illustrates the phased upgrade process. Each column describes the steps to be performed on the corresponding subcluster and the status of the subcluster when operations are performed on the other subcluster.

**Table 16-1** Summary of phased upgrade

| First half of the cluster | Second half of the cluster |
|---------------------------|----------------------------|
|---------------------------|----------------------------|

SF Oracle RAC cluster before the upgrade:

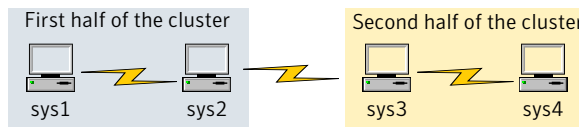

**STEP 1:** Perform the following pre-upgrade steps:

- Switch failover applications.
- Stop all parallel applications.

See “[Step 1: Performing pre-upgrade tasks on the first half of the cluster](#)” on page 179.





**STEP 2:** Upgrade SF Oracle RAC.

See “[Step 2: Upgrading the first half of the cluster](#)” on page 184.

The second half of the cluster is up and running.



**Table 16-1** Summary of phased upgrade (*continued*)

| First half of the cluster                                                                                                                                                                                                                                                                                                          | Second half of the cluster                                                                                                                                                                                                                                                                                                                                                                                                            |
|------------------------------------------------------------------------------------------------------------------------------------------------------------------------------------------------------------------------------------------------------------------------------------------------------------------------------------|---------------------------------------------------------------------------------------------------------------------------------------------------------------------------------------------------------------------------------------------------------------------------------------------------------------------------------------------------------------------------------------------------------------------------------------|
| <p>The first half of the cluster is not running.</p>                                                                                                                                                                                              | <p><b>STEP 3:</b> Perform the following pre-upgrade steps:</p> <ul style="list-style-type: none"> <li>■ Stop all parallel and failover applications.</li> <li>■ Stop SF Oracle RAC.</li> </ul> <p>See <a href="#">“Step 3: Performing pre-upgrade tasks on the second half of the cluster”</a> on page 185.</p> <p><b>The downtime starts now.</b></p>                                                                                |
| <p><b>STEP 4:</b> Perform the following post-upgrade steps:</p> <ul style="list-style-type: none"> <li>■ Start SF Oracle RAC.</li> <li>■ Start all applications.</li> </ul> <p>See <a href="#">“Step 4: Performing post-upgrade tasks on the first half of the cluster”</a> on page 188.</p> <p><b>The downtime ends here.</b></p> | <p>The second half of the cluster is not running.</p>                                                                                                                                                                                                                                                                                               |
| <p>The first half of the cluster is up and running.</p>                                                                                                                                                                                          | <p><b>STEP 5:</b> Upgrade SF Oracle RAC.</p> <p>See <a href="#">“Step 5: Upgrading the second half of the cluster”</a> on page 189.</p> <p><b>STEP 6:</b> Perform the following post-upgrade steps:</p> <ul style="list-style-type: none"> <li>■ Start SF Oracle RAC.</li> <li>■ Start all applications.</li> </ul> <p>See <a href="#">“Step 6: Performing post-upgrade tasks on the second half of the cluster”</a> on page 190.</p> |
| <p>The phased upgrade is complete and both the first and the second half of the cluster are running.</p>                                                                                                                                        |                                                                                                                                                                                                                                                                                                                                                                                                                                       |

## Step 1: Performing pre-upgrade tasks on the first half of the cluster

Perform the following pre-upgrade steps on the first half of the cluster.

## To perform the pre-upgrade tasks on the first half of the cluster

- 1 Back up the following configuration files: `main.cf`, `types.cf`, `CVMTTypes.cf`, `CFSTypes.cf`, `OracleTypes.cf`, `OracleASMTTypes.cf`, `PrivNIC.cf`, `MultiPrivNIC.cf`, `/etc/llttab`, `/etc/llthosts`, `/etc/gabtab`, `/etc/vxfentab`, `/etc/vxfendg`, `/etc/vxfenmode`

For example:

```
cp /etc/VRTSvcs/conf/config/main.cf \
/etc/VRTSvcs/conf/config/main.cf.save
cp /etc/VRTSvcs/conf/config/types.cf \
/etc/VRTSvcs/conf/config/types.cf.save
cp /etc/VRTSvcs/conf/config/OracleTypes.cf \
/etc/VRTSvcs/conf/config/OracleTypes.cf.save
cp /etc/VRTSvcs/conf/config/PrivNIC.cf \
/etc/VRTSvcs/conf/config/PrivNIC.cf.save
cp /etc/VRTSvcs/conf/config/MultiPrivNIC.cf \
/etc/VRTSvcs/conf/config/MultiPrivNIC.cf.save
```

- 2 Installer verifies that recent backups of configuration files in VxVM private region have been saved in `/etc/vx/cbr/bk`.

If not, a warning message is displayed.

---

**Warning:** Backup `/etc/vx/cbr/bk` directory.

---

- 3 Stop all applications that are not configured under VCS but dependent on Oracle RAC or resources controlled by VCS. Use native application commands to stop the application.
- 4 If you plan to continue using Storage Checkpoint or storage tiering policies you created with a 5.0x or earlier version of Storage Foundation for Oracle RAC, complete the following preparatory step before migrating the SFDB repository database to 6.0.1.

See [“Pre-upgrade tasks for migrating the SFDB repository database”](#) on page 165.

- 5 Stop the applications configured under VCS. Stop the Oracle database:

- If the Oracle RAC instance is managed by VCS:

```
hagrps -offline oracle_group -sys sys1
hagrps -offline oracle_group -sys sys2
```

- If the Oracle RAC instance is not managed by VCS, log in as the Oracle user on one of the nodes in the first half of the cluster and shut down the instances:

For Oracle RAC 11.2.0.2 and later versions:

```
$ srvctl stop instance -d db_name \
-n node_name
```

For Oracle RAC 11.2.0.1 and earlier versions:

```
$ srvctl stop instance -d db_name \
-i instance_name
```

- 6
- If the Oracle database is managed by VCS, set the AutoStart value to 0 to prevent the database service group from starting automatically when VCS starts:

```
haconf -makerw
hagrpl -modify oracle_group AutoStart 0
haconf -dump -makero
```

- If the Oracle database is not managed by VCS, change the management policy for the database to manual:

```
$ srvctl modify database -d db_name -y manual
```

7 Unmount the non-system CFS file systems that are not managed by VCS.

- Make sure that no processes are running which make use of mounted shared file system. To verify that no processes use the VxFS or CFS mount point:

```
mount -v | grep vxfs | grep cluster

fuser -cu /mount_point
```

- Unmount the non-system CFS file system:

```
umount /mount_point
```

8 Stop the parallel service groups and switch over failover service groups on each of the nodes in the first half of the cluster:

```
hastop -local -evacuate
```

- 9 Unmount the non-system VxFS file systems that are not managed by VCS.
  - Make sure that no processes are running which make use of mounted shared file system. To verify that no processes use the VxFS or CFS mount point:

```
mount -v | grep vxfs
fuser -cu /mount_point
```

- Unmount the non-system VxFS file system:

```
umount /mount_point
```

- 10 If you created local VxFS mount points on VxVM volumes and added them to `/etc/fstab`, comment out the mount point entries in the file.
- 11 Verify that no VxVM volumes (other than VxVM boot volumes) remain open. Stop any open volumes that are not managed by VCS.
- 12 Verify that only ports a, b, d, and o are open:

```
gabconfig -a
GAB Port Memberships
=====
Port a gen 79c302 membership 0123
Port b gen 79c307 membership 0123
Port d gen 79c306 membership 0123
Port o gen 79c304 membership 0123
```

13 If you plan to upgrade the operating system, stop all ports.

Where *<version>* is the specific release version.

See “[About the Veritas installer](#)” on page 77.

If you are running SF Oracle RAC 5.0.1 RP3, 5.0.1, or earlier versions, stop the ports manually as follows:

```
vcsmmconfig -U
/sbin/init.d/odm stop
/sbin/init.d/vxfen stop
/sbin/gabconfig -U
kcmodule vxfen=unused
kcmodule odm=unused
kcmodule vcsmm=unused
kcmodule vxglm=unused
kcmodule vxgms=unused
lmxconfig -U
kcmodule lmx=unused
kcmodule gab=unused
lltconfig -U
kcmodule llt=unused
```

14 Perform the following steps only if you are upgrading from HP-UX 11i v2:

- If the cluster-wide attribute “UseFence” is set to SCSI3, then reset the value to NONE in the `/etc/VRTSvcs/conf/config/main.cf` file.
- On each node, edit the `/etc/vxfenmode` file to configure I/O fencing in disabled mode.

```
cat /etc/vxfenmode
vxfen_mode=disabled
```

---

**Note:** If you upgrade from SF Oracle RAC 4.1 on HP-UX 11iv2, create `/etc/vxfenmode` file and populate it as above.

---

- On each node, remove the following device files:

```
rm -f /dev/llt
rm -f /dev/gab*
rm -f /dev/vxfen
rm -f /dev/lmx
rm -f /dev/vcsmm
```

## Step 2: Upgrading the first half of the cluster

Perform the following steps to upgrade the first half of the cluster.

### To upgrade the first half of the cluster

- 1 If you plan to upgrade the operating system, rename the `/etc/llttab` file to prevent LLT from starting automatically when the node starts:

```
mv /etc/llttab /etc/llttab.save
```

- 2 Upgrade the operating system, if required.

See [“Upgrading the HP-UX operating system”](#) on page 167.

- 3 Rename the `/etc/llttab` file to its original name:

```
mv /etc/llttab.save /etc/llttab
```

- 4 Make sure that you can run secure shell or remote shell from the node where you launched the installer to the nodes in the second subcluster without requests for a password.

- 5 Upgrade SF Oracle RAC. Navigate to the product directory on the installation media. When you invoke the installer, select the **Full Upgrade** option. The installer automatically detects the phased upgrade though you select the Full Upgrade option.

```
cd product folder
```

```
./installsfrac -upgrade sys1 sys2
```

---

**Note:** After you complete the upgrade of the first half of the cluster, no GAB ports will be shown in the output when you run the `gabconfig -a` command.

---

If you are upgrading from 5.0 releases that use regular license keys (not vxkeyless), then the installer shows the following warning. Select 'n' when prompted for additional licenses.

```
CPI WARNING V-9-40-5323 SFRAC license version 5.0 is not
updated to 6.0 on sys1. It's recommended to upgrade to a 6.0 key.
CPI WARNING V-9-40-5323 SFRAC license version 5.0 is not updated
to 6.0 on sys2. It's recommended to upgrade to a 6.0 key.
```

```
SFRAC is licensed on the systems
```

```
Do you wish to enter additional licenses? [y,n,q,b] (n) n
```



- 6 Change the `/etc/rc.config.d/lltconf` file to prevent LLT from starting automatically after reboot by setting the `LLT_START` attribute to 0:

```
LLT_START=0
```

- 7 For phased upgrades from HP-UX 11iv2, perform the following steps:
  - If you configured fencing to run in "raw" mode, change the mode to "dmp":

```
cp /etc/vxfen.d/vxfenmode_scsi3_dmp /etc/vxfenmode
```

- Reset the value of the cluster-wide attribute "UseFence" to SCSI3 in the `/etc/VRTSvcs/conf/config/main.cf` file.

- 8 Uncomment the VxFS mount point entries in the `/etc/fstab` file.

- 9 Restart the nodes:

```
shutdown -r now
```

You may see some errors in the system log file when the nodes restart. This is because LLT is disabled. Ignore these messages.

## Step 3: Performing pre-upgrade tasks on the second half of the cluster

Perform the following pre-upgrade steps on the second half of the cluster.

### To perform the pre-upgrade tasks on the second half of the cluster

- 1 Stop all applications that are not configured under VCS but dependent on Oracle RAC or resources controlled by VCS. Use native application commands to stop the application.

---

**Note:** The downtime starts now.

---

- 2 If you plan to continue using Storage Checkpoint or storage tiering policies you created with a 5.0x or earlier version of Storage Foundation for Oracle RAC, complete the following preparatory step before migrating the SFDB repository database to 6.0.1.

See ["Pre-upgrade tasks for migrating the SFDB repository database"](#) on page 165.

- 3 Stop all applications that are configured under VCS. Stop the Oracle database:
  - If the Oracle RAC instance is managed by VCS:

```
hagrpl -offline oracle_group -sys sys3
hagrpl -offline oracle_group -sys sys4
```

- If the Oracle RAC instance is not managed by VCS, log in as the Oracle user on one of the nodes in the second half of the cluster and shut down the instances:

For Oracle RAC 11.2.0.2 and later versions:

```
$ srvctl stop instance -d db_name \
-n node_name
```

For Oracle RAC 11.2.0.1 and earlier versions:

```
$ srvctl stop instance -d db_name \
-i instance_name
```

- 4 Unmount the non-system CFS file systems that are not managed by VCS.
  - Make sure that no processes are running which make use of mounted shared file system. To verify that no processes use the VxFS or CFS mount point:

```
mount -v | grep vxfs | grep cluster
fuser -cu /mount_point
```

- Unmount the non-system VxFS file system:

```
umount /mount_point
```

- 5 Stop VCS on each of the nodes in the second half of the cluster:

```
hastop -local
```

- 6 Unmount the non-system VxFS file systems that are not managed by VCS.
  - Make sure that no processes are running which make use of mounted shared file system. To verify that no processes use the VxFS or CFS mount point:

```
mount -v | grep vxfs
fuser -cu /mount_point
```

- Unmount the non-system VxFS file system:

```
umount /mount_point
```

- 7 If you created local VxFS mount points on VxVM volumes and added them to `/etc/fstab`, comment out the mount point entries in the file.
- 8 Verify that no VxVM volumes (other than VxVM boot volumes) remain open. Stop any open volumes that are not managed by VCS.
- 9 Stop all ports.

Where `<version>` is the specific release version.

See [“About the Veritas installer”](#) on page 77.

If you are running SF Oracle RAC 5.0.1 RP3, 5.0.1, or earlier versions, stop the ports manually as follows:

```
vcsmmconfig -U
/sbin/init.d/odm stop
/sbin/init.d/vxfen stop
/sbin/gabconfig -U
kcmodule vxfen=unused
kcmodule odm=unused
kcmodule vcsmm=unused
kcmodule vxgln=unused
kcmodule vxgms=unused
lmxconfig -U
kcmodule lmx=unused
kcmodule gab=unused
lltconfig -U
kcmodule llt=unused
```

- 10 Perform the following steps only if you are upgrading from HP-UX 11i v2:
  - If the cluster-wide attribute “UseFence” is set to SCSI3, then reset the value to NONE in the `/etc/VRTSvcs/conf/config/main.cf` file.
  - On each node, edit the `/etc/vxfenmode` file to configure I/O fencing in disabled mode.

```
cat /etc/vxfenmode
vxfen_mode=disabled
```

---

**Note:** If you upgrade from SF Oracle RAC 4.1 on HP-UX 11iv2, create `/etc/vxfenmode` file and populate it as above.

---

- On each node, remove the following device files:

```
rm -f /dev/llt
rm -f /dev/gab*
rm -f /dev/vxfen
rm -f /dev/lmx
rm -f /dev/vcsmm
```

## Step 4: Performing post-upgrade tasks on the first half of the cluster

Perform the following post-upgrade steps on the first half of the cluster.

### To perform the post-upgrade tasks on the first half of the cluster

- 1 Change `/etc/rc.config.d/lltconf` to start LLT on the nodes by setting the `LLT_START` attribute to 1:

```
LLT_START=1
```

- 2 On any one node on the first half of the cluster, force GAB to form a cluster.

```
gabconfig -x
```

- 3 On the first half of the cluster, start SF Oracle RAC:

```
cd /opt/VRTS/install
./installfrac<version> -start sys1 sys2
```

Where `<version>` is the specific release version.

See [“About the Veritas installer”](#) on page 77.

- 4 On the first half of the cluster, manually mount the VxFS or CFS file systems that are not managed by VCS.
- 5 Relink the SF Oracle RAC libraries with Oracle.

See [“Relinking Oracle RAC libraries with the SF Oracle RAC libraries”](#) on page 228.

- 6 Bring the Oracle database service group online.

If the Oracle database is managed by VCS:

```
hagrpl -online oracle_group -sys node_name
```

If the Oracle database is not managed by VCS:

For Oracle RAC 11.2.0.2 and later versions:

```
$ srvctl start instance -d db_name \
-n node_name
```

For Oracle RAC 11.2.0.1 and earlier versions:

```
$ srvctl start instance -d db_name \
-i instance_name
```

---

**Note:** The downtime ends here.

---

- 7 On the first half of the cluster, start all applications that are not managed by VCS. Use native application commands to start the applications.

## Step 5: Upgrading the second half of the cluster

Perform the following steps to upgrade the second half of the cluster.

### To upgrade the second half of the cluster

- 1 If you plan to upgrade the operating system, rename the `/etc/llttab` file to prevent LLT from starting automatically when the node starts:

```
mv /etc/llttab /etc/llttab.save
```

- 2 Upgrade the operating system, if required.

See [“Upgrading the HP-UX operating system”](#) on page 167.

- 3 Rename the `/etc/llttab` file to its original name:

```
mv /etc/llttab.save /etc/llttab
```

- 4 Make sure that you can run secure shell or remote shell from the node where you launched the installer to the nodes in the second subcluster without requests for a password.

- 5 On the second half of the cluster, upgrade SF Oracle RAC. Navigate to the product directory on the installation media.

When you invoke the installer, select the **Full Upgrade** option. The installer automatically detects the phased upgrade though you select the Full Upgrade option.

```
./installsfrac -upgrade sys3 sys4
```

If you are upgrading from 5.0 releases that use regular license keys (not vxkeyless), then the installer shows the following warning. Select 'n' when prompted for additional licenses.

```
CPI WARNING V-9-40-5323 SFRAC license version 5.0 is not
updated to 6.0 on sys1. It's recommended to upgrade to a 6.0 key.
CPI WARNING V-9-40-5323 SFRAC license version 5.0 is not updated
to 6.0 on sys2. It's recommended to upgrade to a 6.0 key.
```

```
SFRAC is licensed on the systems
Do you wish to enter additional licenses? [y,n,q,b] (n) n
```

- 6 For phased upgrades from HP-UX 11iv2, perform the following steps:
  - If you configured fencing to use the "raw" mode, change the mode to "dmp":

```
cp /etc/vxfen.d/vxfenmode_scsi3_dmp /etc/vxfenmode
```

- Reset the value of the cluster-wide attribute "UseFence" to SCSI3 in the /etc/VRTSvcs/conf/config/main.cf file.

- 7 Uncomment the VxFS mount point entries in the /etc/fstab file.

- 8 Restart the nodes:

```
shutdown -r now
```

## Step 6: Performing post-upgrade tasks on the second half of the cluster

Perform the following post-upgrade steps on the second half of the cluster.

**To perform the post-upgrade tasks on the second half of the cluster**

- 1 Manually mount the VxFS and CFS file systems that are not managed by VCS.
- 2 Relink the SF Oracle RAC libraries with Oracle.

See [“Relinking Oracle RAC libraries with the SF Oracle RAC libraries”](#) on page 228.

- 3 Upgrade VxVM disk group version.

See [“Upgrading CVM protocol version and VxVM disk group version ”](#) on page 233.

- 4 Upgrade disk layout version.

See [“Upgrading disk layout versions”](#) on page 232.

- 5 Bring the Oracle database service group online.

If the Oracle database is managed by VCS:

```
hagrpl -online oracle_group -sys sys3
hagrpl -online oracle_group -sys sys4
```

If the Oracle database is not managed by VCS:

For Oracle RAC 11.2.0.2 and later versions:

```
$ srvctl start instance -d db_name \
-n node_name
```

For Oracle RAC 11.2.0.1 and earlier versions:

```
$ srvctl start instance -d db_name \
-i instance_name
```

- 6 ■ If the Oracle database is managed by VCS, reset the AutoStart value to 1 to enable VCS to bring the database service group online automatically when VCS starts:

```
haconf -makerw
hagrpl -modify oracle_group AutoStart 1
haconf -dump -makero
```

- If the Oracle database is not managed by VCS, change the management policy for the database to automatic:

```
$ srvctl modify database -d db_name -y AUTOMATIC
```

- 7 Start all applications that are not managed by VCS. Use native application commands to start the applications.
- 8 Set or change the product license level, if required.  
See [“Setting or changing the product license level”](#) on page 232.
- 9 Migrate the SFDB repository database.  
See [“Post upgrade tasks for migrating the SFDB repository database”](#) on page 234.
- 10 Upgrade Oracle RAC, if required.

---

**Note:** Oracle RAC 11g Release 1 Clusterware is not supported. Make sure that you install Oracle RAC 11g Release 2 Grid Infrastructure in order to use the Oracle RAC 11g Release 1 database. All database versions starting from Oracle 10g Release 2 and later are supported.

---

For instructions, see the chapter *Upgrading Oracle RAC* in this document.

- 11 If you want to upgrade CP server systems that use VCS or SFHA to 6.0.1, make sure that you upgraded all application clusters to version 6.0.1. Then, upgrade VCS or SFHA on the CP server systems.

For instructions to upgrade VCS or SFHA on the CP server systems, see the VCS or SFHA installation guide.



# Performing a rolling upgrade of SF Oracle RAC

This chapter includes the following topics:

- [About rolling upgrades](#)
- [Supported rolling upgrade paths](#)
- [Preparing to perform a rolling upgrade to SF Oracle RAC 6.0.1](#)
- [Performing a rolling upgrade using the installer](#)

## About rolling upgrades

The rolling upgrade minimizes downtime for highly available clusters to the amount of time that it takes to perform a service group failover. The rolling upgrade has two main phases where the installer upgrades kernel depots in phase 1 and VCS agent depots in phase 2.

---

**Note:** You need to perform a rolling upgrade on a completely configured cluster.

---

The following is an overview of the flow for a rolling upgrade:

1. The installer performs prechecks on the cluster.
2. Application downtime occurs during the first phase as the installer moves service groups to free nodes for the upgrade. The only downtime that is incurred is the normal time required for the service group to fail over. The downtime is limited to the applications that are failed over and not the entire cluster.

3. The installer performs the second phase of the upgrade on all of the nodes in the cluster. The second phase of the upgrade includes downtime of the Veritas Cluster Server (VCS) engine HAD, but does not include application downtime.

[Figure 17-1](#) illustrates an example of the installer performing a rolling upgrade for three service groups on a two node cluster.

**Figure 17-1** Example of the installer performing a rolling upgrade

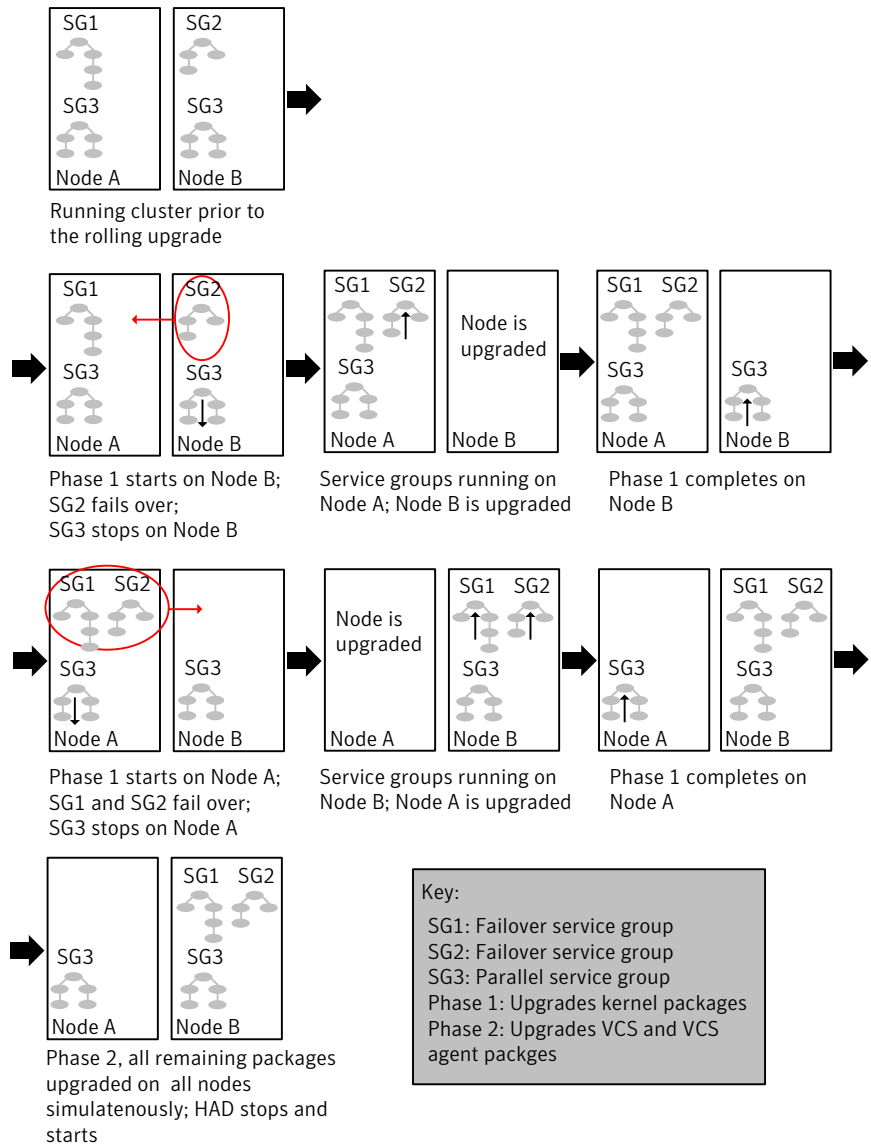

The following limitations apply to rolling upgrades:

- Rolling upgrades are not compatible with phased upgrades. Do not mix rolling upgrades and phased upgrades.

## Supported rolling upgrade paths

You can perform a rolling upgrade of SF Oracle RAC with the script-based installer, the Web-based installer, or manually.

The rolling upgrade procedures support only minor operating system upgrades.

[Table 17-1](#) shows the versions of SF Oracle RAC for which you can perform a rolling upgrade to SF Oracle RAC 6.0.1.

**Table 17-1** Supported rolling upgrade paths

| Platform | SF Oracle RAC version             |
|----------|-----------------------------------|
| HP-UX    | 5.1SP1, 5.1SP1RPs, 6.0 and 6.0RP1 |

---

**Note:** Before performing a rolling upgrade from version 5.1SP1RP3 to version 6.0.1, install patch VRTSvxfen-5.1SP1RP3P2. For downloading the patch, search VRTSvxfen-5.1SP1RP3P2 in [Patch Lookup](#) on the [SORT](#) website.

---

## Preparing to perform a rolling upgrade to SF Oracle RAC 6.0.1

Perform the preparatory steps in this section if you are performing a rolling upgrade of the cluster. Before you upgrade, make sure that your systems meet the hardware and software requirements for this release.

---

**Note:** If you plan to upgrade the operating system, make sure that you upgrade all nodes before you start rolling upgrade of SF Oracle RAC.

---

### To prepare to upgrade SF Oracle RAC

Perform the steps on the first subcluster.

- 1 Log in as superuser to one of the nodes in the subcluster.
- 2 Back up the following configuration files on your system: `main.cf`, `types.cf`, `CVMTypes.cf`, `CFSTypes.cf`, `OracleTypes.cf`, `OracleASMTypes.cf`, `PrivNIC.cf`, `MultiPrivNIC.cf`, `CRSResource.cf`, `/etc/llttab`, `/etc/lllhosts`, `/etc/gabtab`, `/etc/vxfentab`, `/etc/vxfendg`, `/etc/vxfenmode`

For example:

```
cp /etc/VRTSvcs/conf/config/main.cf \
/etc/VRTSvcs/conf/config/main.cf.save
```

- 3 Installer verifies that recent backups of configuration files in VxVM private region have been saved in `/etc/vx/cbr/bk`.

If not, a warning message is displayed.

---

**Warning:** Backup `/etc/vx/cbr/bk` directory.

---

- 4 Stop the applications that use VxFS or VxVM disk groups on each node, whether local or CFS.

If the applications are under VCS control:

```
hagrps -offline grp_name -sys node_name
```

If the applications are not under VCS control:

Use native application commands to stop the application.

- 5 Switch over all failover service groups to the nodes in the other subcluster:

```
hagrps -switch grp_name -to sys_name
```

- 6 For Oracle RAC 10g and Oracle RAC 11g:  
Stop the Oracle RAC resources on each node.

- If the database instances are managed by VCS, take the corresponding VCS service groups offline. As superuser, enter:

```
hagrps -offline grp_name -sys node_name
```

- If the database instances are not managed by VCS, then run the following on one node:

For Oracle RAC 11.2.0.2 and later versions:

```
$ srvctl stop instance -d db_name \
-n node_name
```

For Oracle RAC 11.2.0.1 and earlier versions:

```
$ srvctl stop instance -d db_name \
-i instance_name
```

- 7 ■ If the Oracle database is managed by VCS, set the AutoStart value to 0 to prevent the database service group from starting automatically when VCS starts. Failing to perform this step results in the database attempting to come online after the upgrade; the attempt fails due to the presence of old libraries on the system.

```
haconf -makerw
hagrps -modify oracle_group AutoStart 0
haconf -dump -makero
```

- If the Oracle database is not managed by VCS, change the management policy for the database to manual:

```
$ srvctl modify database -d db_name -y manual
```

- 8 Unmount all the non-system CFS mount points which are not under VCS control.

```
mount -v |grep vxfs | grep cluster

umount /mount_point
```

Make sure that no processes are running which make use of mounted shared file system or shared volumes.

```
fuser -cu /mount_point
```

- 9 Take all the parallel VCS service groups offline on each of the nodes in the current subcluster:

```
hagrps -offline grp_name -sys sys_name
```

- 10 Unmount all the non-system VxFS mount points which are not under VCS control.

```
mount -v |grep vxfs

umount /mount_point
```

- 11 If you plan to continue using the Storage Foundation for Databases (SFDB) tools, you must prepare to migrate the SFDB repository database before upgrading to SF Oracle RAC 6.0.1.

See [“Pre-upgrade tasks for migrating the SFDB repository database”](#) on page 165.

## Performing a rolling upgrade using the installer

Use a rolling upgrade to upgrade Veritas Storage Foundation for Oracle RAC to the latest release with minimal application downtime.

### Performing a rolling upgrade using the script-based installer

Before you start the rolling upgrade, make sure that Veritas Cluster Server (VCS) is running.

#### To perform a rolling upgrade

- 1 Complete the preparatory steps on the first sub-cluster.

See [“Preparing to perform a rolling upgrade to SF Oracle RAC 6.0.1”](#) on page 196.

- 2 Log in as superuser and mount the SF Oracle RAC 6.0.1 installation media.
- 3 From root, start the installer.

```
./installer
```

- 4 From the menu, select `Upgrade` and from the sub menu, select `Rolling Upgrade`.
- 5 The installer suggests system names for the upgrade. Enter `Yes` to upgrade the suggested systems, or enter `No`, and then enter the name of any one system in the cluster on which you want to perform a rolling upgrade.
- 6 The installer checks system communications, release compatibility, version information, and lists the cluster name, ID, and cluster nodes. Type `y` to continue.

- 7 The installer inventories the running service groups and determines the node or nodes to upgrade in phase 1 of the rolling upgrade. Type **y** to continue. If you choose to specify the nodes, type **n** and enter the names of the nodes.
- 8 The installer performs further prechecks on the nodes in the cluster and may present warnings. You can type **y** to continue or quit the installer and address the precheck's warnings.
- 9 Review the end-user license agreement, and type **y** if you agree to its terms.
- 10 After the installer shows the package list, it detects if there are online failover service groups on the nodes to be upgraded. If there are online failover service groups, the installer prompts you to do one of the following:

- Manually switch service groups
- Use the CPI to automatically switch service groups

The downtime is the time that it normally takes for the service group's failover.

- 11 The installer prompts you to stop the applicable processes. Type **y** to continue. The installer evacuates all service groups to the node or nodes that are not upgraded at this time. The installer stops parallel service groups on the nodes that are to be upgraded.
- 12 The installer stops relevant processes, uninstalls old kernel depots, and installs the new depots. When prompted, enable replication or global cluster capabilities, if required, and register the software.
- 13 Exit the installer and reboot the nodes where upgrade is performed.

```
shutdown -r now
```

---

**Note:** The Oracle service group is offline as the AutoStart attribute is set to 0 to prevent the service group from starting automatically. The service group is started later in the process.

---

- 14 Manually mount the VxFS and CFS file systems that are not managed by VCS.
- 15 Relink the SF Oracle RAC libraries with Oracle by choosing the option **Relink Oracle Database Binary** from the program menu.  
 See [“Relinking Oracle RAC libraries with the SF Oracle RAC libraries”](#) on page 228.
- 16 Bring the Oracle database service group online.

- If VCS manages the Oracle database:

```
hagrps -online oracle_group -sys node_name
```



- If VCS does not manage the Oracle database:

```
$ srvctl start database -d db_name
```

- 17 Start all applications that are not managed by VCS. Use native application commands to start the applications.
- 18 Complete the preparatory steps on the nodes that you have not yet upgraded. See [“Preparing to perform a rolling upgrade to SF Oracle RAC 6.0.1”](#) on page 196.
- 19 Repeat step 2 through step 17.

For clusters with larger number of nodes, this process may repeat several times. Service groups come down and are brought up to accommodate the upgrade.

This completes phase 1 of the upgrade.

- 20 ■ If VCS manages the Oracle database, reset the AutoStart value to 1 to enable VCS to bring the database service group online when VCS starts:

```
haconf -makerw
hagrpl -modify oracle_group AutoStart 1
haconf -dump -makero
```

- If VCS does not manage the Oracle database, change the management policy for the database to automatic:

```
$ srvctl modify database -d db-name -y AUTOMATIC
```

- 21 Migrate the SFDB repository database. See [“Post upgrade tasks for migrating the SFDB repository database”](#) on page 234.
- 22 Restart the installer to begin Phase 2. This phase includes downtime for the VCS engine (HAD), which does not include application downtime. Type **y** to continue.
- 23 The installer determines the remaining depots to upgrade. Press **Enter** to continue.
- 24 The installer stops Veritas Cluster Server (VCS) processes but the applications continue to run. Type **y** to continue.

The installer performs prechecks, uninstalls old depots, and installs the new depots. It performs post-installation tasks, and the configuration for the upgrade.

- 25 Type **y** or **n** to help Symantec improve the automated installation.
- 26 If you have network connection to the Internet, the installer checks for updates. If updates are discovered, you can apply them now.
- 27 A prompt message appears to ask if the user would like to read the summary file. You can choose **y** if you want to read the install summary file.
- 28 Upgrade Oracle RAC to the supported version.

---

**Note:** Oracle RAC 11g Release 1 Clusterware is not supported. Make sure that you install Oracle RAC 11g Release 2 Grid Infrastructure in order to use the Oracle RAC 11g Release 1 database. All database versions starting from Oracle 10g Release 2 and later are supported.

---

For instructions, see the chapter *Upgrading Oracle RAC* in this document.

## Performing a rolling upgrade of SF Oracle RAC using the Web-based installer

This section describes using the Veritas Web-based installer to perform a rolling upgrade. The installer detects and upgrades the product that is currently installed on the specified system or systems. If you want to upgrade to a different product, you may need to perform additional steps.

See [“About rolling upgrades”](#) on page 193.

### To start the rolling upgrade—phase 1

- 1 Perform the required steps to save any data that you wish to preserve. For example, take back-ups of configuration files.
- 2 Complete the preparatory steps on the first sub-cluster.  
See [“Preparing to perform a rolling upgrade to SF Oracle RAC 6.0.1”](#) on page 196.
- 3 Start the Web-based installer, if it is not already running.  
See [“Starting the Veritas Web-based installer”](#) on page 122.
- 4 In the Task pull-down menu, select `Rolling Upgrade`.  
Click the **Next** button to proceed.

- 5 Enter the name of any one system in the cluster on which you want to perform a rolling upgrade. The installer identifies the cluster information of the system and displays the information.

Click **Yes** to confirm the cluster information. The installer now displays the nodes in the cluster that will be upgraded during phase 1 of the upgrade.

- 6 Review the systems that the installer has chosen for phase 1 of the rolling upgrade. These systems are chosen to minimize downtime during the upgrade.

Click **Yes** to proceed.

The installer validates systems. If it throws an error, address the error and return to the installer.

- 7 Review the End User License Agreement (EULA). To continue, select **Yes, I agree** and click **Next**.

- 8 If you have online failover service groups, the installer prompts you to choose to switch these service groups either manually or automatically. Choose any option and follow the steps to switch all the failover service groups to the other subcluster.

- 9 The installer stops all processes. Click **Next** to proceed.

The installer removes old software and upgrades the software on the systems that you selected.

- 10 If you want to enable volume or file replication or global cluster capabilities, select from the following options:

- Veritas Volume Replicator
- Veritas File Replicator
- Global Cluster Option

Click **Register** to register the software. Click the **Next** button.

- 11 When prompted by the installer, reboot the nodes on the first half of the cluster.
- 12 Manually mount the VxFS and CFS file systems that are not managed by VCS.
- 13 Relink the SF Oracle RAC libraries with Oracle by choosing the option **Relink Oracle Database Binary** from the program menu.

See [“Relinking Oracle RAC libraries with the SF Oracle RAC libraries”](#) on page 228.

- 14 Bring the Oracle database service group online.

- If VCS manages the Oracle database:

```
hagrps -online oracle_group -sys node_name
```

- If VCS does not manage the Oracle database:

```
srvctl start database -d db_name
```

- 15 Start all applications that are not managed by VCS. Use native application commands to start the applications.
- 16 When prompted, perform step 2 through step 12 on the nodes that you have not yet upgraded.
- 17 ■ If VCS manages the Oracle database, reset the AutoStart value to 1 to enable VCS to bring the database service group online when VCS starts:

```
haconf -makerw
hagrps -modify oracle_group AutoStart 1
haconf -dump -makero
```

- If VCS does not manage the Oracle database, change the management policy for the database to automatic:

```
$ srvctl modify database -d db-name -y AUTOMATIC
```

- 18 Migrate the SFDB repository database.

See [“Post upgrade tasks for migrating the SFDB repository database”](#) on page 234.

- 19 When prompted, start phase 2. Click **Yes** to continue with the rolling upgrade.

#### To upgrade the non-kernel components—phase 2

- 1 The installer detects the information of cluster and the state of rolling upgrade. The installer validates systems. Click **Next**. If it throws an error, address the error and return to the installer.
- 2 Review the End User License Agreement (EULA). To continue, select **Yes, I agree** and click **Next**.
- 3 The installer stops the `HAD` and `CmdServer` processes in phase 2 of the rolling upgrade process. Click **Next** to proceed.
- 4 The installer removes old software and upgrades the software on the systems that you selected. Review the output and click the **Next** button when prompted. Register the software and click **Next** to proceed. The installer starts all the relevant processes and brings all the service groups online.
- 5 If you have network connection to the Internet, the installer checks for updates. If updates are discovered, you can apply them now.

- 6 A prompt message appears to ask if the user would like to read the summary file. You can choose **y** if you want to read the install summary file.
- 7 Upgrade Oracle RAC, if required.

---

**Note:** Oracle RAC 11g Release 1 Clusterware is not supported. Make sure that you install Oracle RAC 11g Release 2 Grid Infrastructure in order to use the Oracle RAC 11g Release 1 database. All database versions starting from Oracle 10g Release 2 and later are supported.

---

For instructions, see the chapter *Upgrading Oracle RAC* in this document.

The upgrade is complete.

# Upgrading from Storage Foundation High Availability products to SF Oracle RAC 6.0.1

This chapter includes the following topics:

- [About upgrading from Storage Foundation High Availability products to SF Oracle RAC 6.0.1](#)
- [Upgrading from Storage Foundation High Availability products to SF Oracle RAC 6.0.1](#)

## About upgrading from Storage Foundation High Availability products to SF Oracle RAC 6.0.1

You can upgrade from earlier versions of the following Symantec high availability products to SF Oracle RAC 6.0.1:

- Storage Foundation High Availability
- Storage Foundation Cluster File System

---

**Note:** The installer does not support direct upgrade from earlier versions of the products, for example from Storage Foundation Cluster File System 5.0, to SF Oracle RAC 6.0.1. You must first upgrade to version 6.0.1 of the installed product, then install SF Oracle RAC 6.0.1.

---

# Upgrading from Storage Foundation High Availability products to SF Oracle RAC 6.0.1

Perform the steps in the following procedure to upgrade Storage Foundation High Availability products to SF Oracle RAC 6.0.1.

## To upgrade Storage Foundation High Availability products to SF Oracle RAC 6.0.1

- 1 If you are running an earlier version of the product, upgrade to version 6.0.1 of the product.

For instructions, see the installation guide of the product.

- 2 Install SF Oracle RAC 6.0.1.

- 3 When you are prompted to configure SF Oracle RAC, enter **y** at the prompt:

```
Would you like to configure SF Oracle RAC on sys1? [y,n,q] (n) y
```

The program menu is displayed.

- 4 Select the option **Configure SF Oracle RAC sub-components**.

If VCS is configured in your environment, the installation program detects the VCS configuration.

---

**Note:** Do not reconfigure VCS when you are prompted by the installation program:

```
Do you want to re-configure VCS? [y,n,q] (n)
```

---

The installation program creates the VCS configuration file and the `/etc/vcsmmtab` file and starts all processes.

5 Verify that all GAB ports are up and running.

```
gabconfig -a
GAB Port Memberships
=====
Port a gen ada401 membership 01
Port b gen ada40d membership 01
Port d gen ada409 membership 01
Port f gen ada41c membership 01
Port h gen ada40f membership 01
Port o gen ada406 membership 01
Port u gen ada41a membership 01
Port v gen ada416 membership 01
Port w gen ada418 membership 01
Port y gen ada42a membership 01
```

6 Restart ODM on all nodes. This will start ODM in clustered mode.

```
/sbin/init.d/odm stop
/sbin/init.d/odm start
```

7 If fencing is not configured, configure fencing.

For instructions, see the chapter *Configuring SF Oracle RAC clusters for data integrity* in this document.

- 8
- If you have neither single-instance Oracle nor Oracle RAC running in your environment, install Oracle RAC.  
 For instructions, see the chapter *Installing and configuring Oracle RAC* in this document.
  - If you have a single-instance Oracle database in your environment, migrate the database to Oracle RAC.  
 For instructions, see the chapter *Migrating from single instance Storage Foundation for Oracle HA to SF Oracle RAC* in this document.



# Migrating from single instance Storage Foundation for Oracle HA to SF Oracle RAC

This chapter includes the following topics:

- [Migration overview](#)
- [Migration requirements](#)
- [Before you migrate](#)
- [Migrating to SF Oracle RAC 6.0.1](#)
- [Sample configuration files](#)

## Migration overview

This chapter provides instructions for migrating from Veritas Storage Foundation for Oracle High Availability to Veritas Storage Foundation for Oracle RAC (SF Oracle RAC).

---

**Note:** For Oracle RAC 11g Release 2: The instructions in this chapter support migration to administrator-managed databases only.

---

[Figure 19-1](#) illustrates the migration from Storage Foundation for Oracle HA to SF Oracle RAC.

**Figure 19-1** Migration from Storage Foundation for Oracle HA to SF Oracle RAC

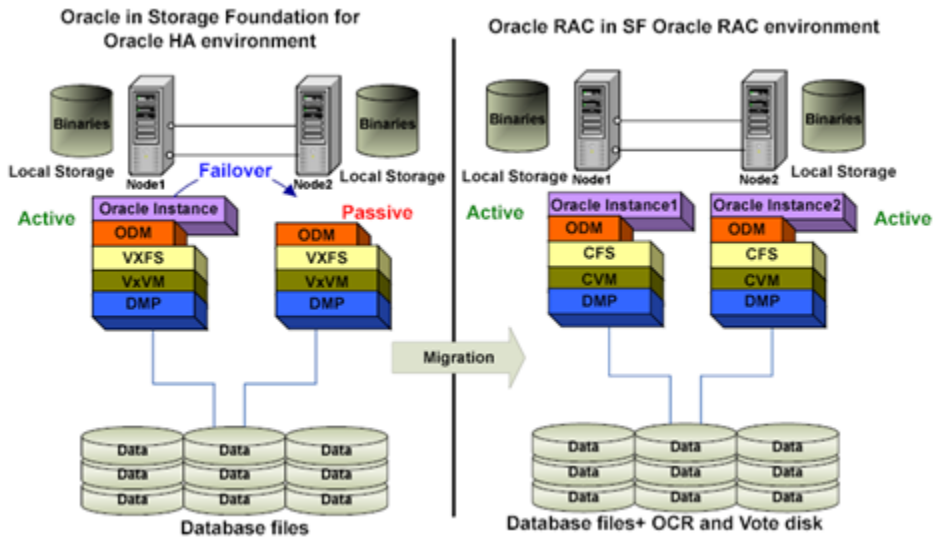

## Sample configuration before and after migration

Table 19-1 describes a sample existing configuration in a Storage Foundation for Oracle HA database environment.

**Table 19-1** Configuration in a Storage Foundation for Oracle HA database environment

| Host name | Instance name | Database name | Oracle home                                                                                                                                           | Database file storage           |
|-----------|---------------|---------------|-------------------------------------------------------------------------------------------------------------------------------------------------------|---------------------------------|
| sys1      | vrts          | vrts          | /u01/app/oracle/<br>product/ <i>release</i> /dbhome_1<br><br>where <i>release</i> is 10.2.0, 11.1.0, or 11.2.0<br>depending on the Oracle RAC version | Shared<br>storage using<br>VxFS |
| sys2      | vrts          | vrts          | /u01/app/oracle/<br>product/ <i>release</i> /dbhome_1<br><br>where <i>release</i> is 10.2.0, 11.1.0, or 11.2.0<br>depending on the Oracle RAC version | Shared<br>storage using<br>VxFS |

Table 19-2 describes a sample configuration in an SF Oracle RAC database environment.

**Table 19-2** Configuration in an SF Oracle RAC environment

| Host name | Instance name | Database name | Oracle home                                                                                                                                          | Database file storage             | OCR and voting disk         |
|-----------|---------------|---------------|------------------------------------------------------------------------------------------------------------------------------------------------------|-----------------------------------|-----------------------------|
| sys1      | vrts1         | vrts          | /u01/app/oracle/<br>product/ <i>release</i> /dbhome_1<br>where <i>release</i> is 10.2.0, 11.1.0,<br>or 11.2.0 depending on the Oracle<br>RAC version | Shared<br>storage<br>using<br>CFS | Resides<br>on CVM<br>or CFS |
| sys2      | vrts2         | vrts          | /u01/app/oracle/<br>product/ <i>release</i> /dbhome_1<br>where <i>release</i> is 10.2.0, 11.1.0,<br>or 11.2.0 depending on the Oracle<br>RAC version | Shared<br>storage<br>using<br>CFS | Resides<br>on CVM<br>or CFS |

## Migration requirements

Make sure that you meet the following requirements before migrating to SF Oracle RAC:

- Storage Foundation for Oracle HA version 6.0.1 is installed on the systems.
- Oracle 10g Release 2 or Oracle 11g Release 2 is installed on the systems.

---

**Note:** In the case of Oracle RAC 11g Release 1, only the database is supported.

---

## Before you migrate

Before you migrate to SF Oracle RAC, complete the following tasks:

- Set up the single instance Storage Foundation for Oracle database with the following configuration:
  - Storage Foundation for Oracle HA installed on all nodes
  - Oracle binaries installed on each node
  - Oracle database created on shared storage using Veritas File System (VxFS)
- Back up the existing database before the migration.

## Migrating to SF Oracle RAC 6.0.1

Perform the following steps to migrate from Storage Foundation for Oracle HA to SF Oracle RAC.

1. Migrate Storage Foundation for Oracle HA to SF Oracle RAC.  
 See [“Migrating Storage Foundation for Oracle HA to SF Oracle RAC”](#) on page 212.
2. Migrate single instance Oracle database to Oracle RAC database.  
 See [“Migrating a single instance Oracle database to Oracle RAC database”](#) on page 213.
3. Complete the post-migration tasks.  
 See [“Completing post-migration tasks”](#) on page 217.

## Migrating Storage Foundation for Oracle HA to SF Oracle RAC

Perform the following steps to migrate from Storage Foundation for Oracle HA to SF Oracle RAC.

### To migrate from Storage Foundation for Oracle HA to SF Oracle RAC

- 1 Log in as a superuser.
- 2 Back up the existing Storage Foundation for Oracle database HA resource configuration:  

```
cp -rp /etc/VRTSvcs/conf/config config.old
```
- 3 Take the database service groups offline:  

```
hagr -offline group_name -any
```
- 4 Unmount the non-system VxFS mount points that are not managed by VCS:  

```
umount mount_point
```
- 5 Stop all the other VCS service groups.  
 To view the current state of the service groups:  

```
hagr -state
```

 To stop each group:  

```
hagr -offline servicegroup -sys node_name
```

6 Freeze the VCS service groups:

```
haconf -makerw
hagrps -freeze servicegroup -persistent
haconf -dump -makero
```

7 Stop VCS on all nodes:

```
hastop -all -force
```

8 Install and configure SF Oracle RAC.

For information on installing and configuring SF Oracle RAC, see *Section 2: Installation and configuration of SF Oracle RAC* in this guide.

9 Unfreeze the VCS service groups:

```
haconf -makerw
hagrps -unfreeze servicegroup -persistent
haconf -dump -makero
```

## Migrating a single instance Oracle database to Oracle RAC database

Complete the steps in the following procedure for migrating a single instance Oracle database to the Oracle RAC database.

### To migrate a single instance Oracle database to Oracle RAC database

1 Install Oracle Clusterware.

For information on installing Oracle Clusterware, see *Section 4: Installation and upgrade of Oracle RAC* in this guide.

2 Import the single instance Storage Foundation for Oracle database HA storage disk group in shared mode:

```
vxvg -s import oradatadg
```

where oradatadg is a disk group in the Storage Foundation for Oracle database HA environment.

In an Oracle RAC environment, all instances concurrently access a single database. Thus, all datafiles, control files, SPFILE, redo log files and archive log files must reside on shared storage.

- 3 Mount the file system in cluster mode on all nodes:

```
mount -F vxfs -o cluster \
/dev/vx/dsk/oradatadg/oradatavol /oradata
```

where oradata is a file system in the Storage Foundation for Oracle database HA environment.

- 4 Before relinking the Oracle database binaries with the Veritas libraries run the following commands:

On Itanium systems:

```
rm $ORACLE_HOME/lib/libskgxn2.so
ln -s /opt/nmapi/nmapi2/lib/hpux64/libnmapi2.so \
$ORACLE_HOME/lib/libskgxn2.so
```

- 5 Relink Oracle binaries with Veritas libraries.

See [“Relinking Oracle RAC libraries with the SF Oracle RAC libraries”](#) on page 228.

- 6 Start the database as an Oracle user from any one of the nodes in the cluster using SQLPLUS:

```
$ export ORACLE_SID=vrts
$ export ORACLE_HOME=/u02/app/oracle/product/11.2.0/dbhome_1
$ /u02/app/oracle/product/11.2.0/dbhome_1/bin/sqlplus "/as sysdba"
```

where vrts is a database in the Storage Foundation for Oracle database HA environment.

- 7 Add redo logs.** Each instance requires its own redo thread. The following example assumes a two node configuration, with sys1 and sys2 as the nodes in the cluster. The existing redo thread will be used by sys1.

To add a new redo thread, log on to sys2 as Oracle user and run the following commands:

```
SQL> alter database add logfile thread 2
 group 4 ('/oradata/vrts/redo04.log') size 50M REUSE;
Database altered
```

```
SQL> alter database add logfile thread 2
 group 5 ('/oradata/vrts/redo05.log') size 50M REUSE;
Database altered.
```

```
SQL> alter database add logfile thread 2
 group 6 ('/oradata/vrts/redo06.log') size 50M REUSE;
Database altered
```

- 8 Enable redo log thread.** While enabling, it may be designated as a public thread or a private thread:

```
SQL> ALTER DATABASE ENABLE PUBLIC THREAD 2;
OR
SQL> ALTER DATABASE ENABLE PRIVATE THREAD 2;
```

- 9 Add UNDO tablespaces for each additional instance:**

```
SQL> create undo tablespace UNDOTBS2 datafile\
'/oradata/vrts/undotbs02.dbf' size 500M autoextend on;
```

- 10 Create the cluster views needed for Oracle RAC:**

```
SQL> @?/rdbms/admin/catclust
```

- 11 If you are using an SPFILE, create a PFILE from it:**

```
SQL> create pfile='/tmp/initORA.ora' from spfile
```

**12 Edit the Oracle initialization parameter file `/tmp/initORA.ora` to include cluster parameters:**

```
*.cluster_database_instances=2
*.cluster_database=TRUE
vrts1.instance_name=vrts1
vrts2.instance_name=vrts2
vrts1.instance_number=1
vrts2.instance_number=2
vrts1.thread=1
vrts2.thread=2
vrts1.undo_tablespace='UNDOTBS1'
vrts2.undo_tablespace='UNDOTBS2'
vrts1.local_listener= 'LISTENER_SYS1'
vrts2.local_listener= 'LISTENER_SYS2'
vrts1.remote_listener= 'LISTENERS_VRTS'
vrts2.remote_listener= 'LISTENERS_VRTS'
```

**13 Start the Oracle initialization parameter file:**

```
SQL> connect / as sysdba
SQL> shutdown immediate
SQL> startup pfile='/tmp/initORA.ora'
```

**14 If the database starts successfully using the Oracle initialization parameter file, create an spfile in a shared location:**

```
SQL> create spfile='sharedlocation/spfiledbrac.ora'\
from pfile='/tmp/initORA.ora'
```

**15 On each node create a link in `$ORACLE_HOME/dbs` to the shared spfile directory.**

For sys1:

```
cd $ORACLE_HOME/dbs
ln -s sharedlocation/spfiledbrac.ora spfiledbrac1.ora
```

For sys2:

```
cd $ORACLE_HOME/dbs
ln -s sharedlocation/spfiledbrac.ora spfiledbrac2.ora
```



16 Add the database and instances to the cluster registry:

```
srvctl add database -d vrts -o $ORACLE_HOME
srvctl add instance -d vrts -i vrts1 -n sys1
srvctl add instance -d vrts -i vrts2 -n sys2
```

17 Stop and start the database:

```
srvctl stop database -d vrts
srvctl start database -d vrts
```

18 For Oracle RAC 10g Release 2/Oracle RAC 11g Release 1:

Configure Oracle listener using Oracle Net Configuration Assistant (NETCA).

---

**Note:** The NETCA utility requires xterm capability.

---

```
$ export DISPLAY=localhost:0.0
$ ORACLE_HOME/bin/netca
```

The NETCA utility starts Oracle listener on both nodes.

This completes the migration of the single-instance Oracle database to an Oracle RAC configuration.

## Completing post-migration tasks

Perform the steps in the following procedure to complete the migration process. The examples in the procedures assume a two-node SF Oracle RAC cluster with the nodes sys1 and sys2.

**To complete the post-migration tasks:**

**1 For Oracle RAC 10g Release 2/Oracle RAC 11g Release 1:**

Copy the file `tnsnames.ora` to the directory `$ORACLE_HOME/network/admin` on all nodes. A sample `tnsnames.ora` file is given below:

```

VRTS =
 (DESCRIPTION =
 (ADDRESS = (PROTOCOL = TCP) (HOST = sys1-vip) (PORT = 1521))
 (ADDRESS = (PROTOCOL = TCP) (HOST = sys2-vip) (PORT = 1521))
 (LOAD_BALANCE = yes)
 (CONNECT_DATA =
 (SERVER = DEDICATED)
 (SERVICE_NAME = vrts)
)
)
VRTS1 =
 (DESCRIPTION =
 (ADDRESS = (PROTOCOL = TCP) (HOST = sys1-vip) (PORT = 1521))
 (CONNECT_DATA =
 (SERVER = DEDICATED)
 (SERVICE_NAME = vrts)
 (INSTANCE_NAME = vrts1)
)
)
VRTS2 =
 (DESCRIPTION =
 (ADDRESS = (PROTOCOL = TCP) (HOST = sys2-vip) (PORT = 1521))
 (CONNECT_DATA =
 (SERVER = DEDICATED)
 (SERVICE_NAME = vrts)
 (INSTANCE_NAME = vrts2)
)
)
LISTENERS_VRTS =
 (ADDRESS_LIST =
 (ADDRESS = (PROTOCOL = TCP) (HOST = sys1-vip) (PORT = 1521))
 (ADDRESS = (PROTOCOL = TCP) (HOST = sys2-vip) (PORT = 1521))
)

```

For Oracle RAC 11g Release 2, see the Oracle documentation to update the `tnsnames.ora` file.

- 2 Optional: Add services to a database and assign them to instances. You can create services manually or by using the Database Configuration Assistant (DBCA) utility.

In Real Application Clusters (RAC), a service can span one or more instances and facilitate real workload balancing based on real transaction performance. You can control the instances in your cluster that are allocated to different services at different times.

To create the services manually:

```
srvctl add service -d vrts -s ORA_TAF -r vrts1, vrts2
```

- 3 Configure the CSSD, PrivNIC or MultiPrivNIC and Oracle resource agents in the VCS configuration file.

For more information see *Section 4: Installation and upgrade of Oracle RAC* in this guide.

- 4 Depending on your deployment needs you may perform the following optional tasks:
  - Update the application (database client) configuration to connect to Oracle RAC database (if required) and to take advantage of Oracle RAC features like load balancing and scalability.
  - Update the VCS configuration file for any additional resources, which were present in the VCS configuration prior to the migration process.

## Migrating Storage Foundation for Databases (SFDB) objects from single instance Oracle to Oracle RAC

After migrating from Storage Foundation HA to Storage Foundation for Oracle RAC, the Storage Foundation for Databases (SFDB) objects created in a single instance Oracle environment will not be available in the Oracle RAC environment.

### To re-create the SFDB repository

- 1 Run the following command:

```
$ /opt/VRTS/bin/dbed_update -S $ORACLE_SID -H $ORACLE_HOME
```

- 2 Re-create the SFDB objects that existed in the Storage Foundation HA environment. They will now be supported for SFRAC.

For information on configuring SFDB objects, see the *Storage Foundation: Storage and Availability Management for Oracle Databases* guide.

## Sample configuration files

This section illustrates sample configurations for the following files:

|                                      |                                                                                                                                                                                                               |
|--------------------------------------|---------------------------------------------------------------------------------------------------------------------------------------------------------------------------------------------------------------|
| VCS configuration file               | See <a href="#">“VCS configuration file for Storage Foundation for Oracle HA”</a> on page 220.<br><br>See <a href="#">“VCS configuration file for SF Oracle RAC”</a> on page 223.                             |
| Oracle initialization parameter file | See <a href="#">“Oracle initialization parameter file for Storage Foundation for Oracle HA”</a> on page 221.<br><br>See <a href="#">“Oracle initialization parameter file for SF Oracle RAC”</a> on page 226. |
| tnsnames.ora                         | See <a href="#">“tnsnames.ora for Storage Foundation for Oracle HA”</a> on page 222.<br><br>See <a href="#">“tnsnames.ora file for SF Oracle RAC”</a> on page 227.                                            |
| listener.ora                         | See <a href="#">“listener.ora for Storage Foundation for Oracle HA”</a> on page 223.<br><br>See <a href="#">“listener.ora file for SF Oracle RAC”</a> on page 227.                                            |

## VCS configuration file for Storage Foundation for Oracle HA

The sample VCS configuration file for Storage Foundation for Oracle HA is as follows:

```
include "types.cf"
include "OracleTypes.cf"

cluster sfha_clus (
 UserNames = { admin = bQRjQLqNRmRRpZRlQO }
 Administrators = { admin }
)

system sys1 (
)

system sys2 (
)
```

```

group sfora (
 SystemList = { sys1 = 0, sys2 = 1 }
 AutoStartList = { sys1, sys2 }
)

DiskGroup oradatadg (
 Critical = 0
 DiskGroup = oradatadg
)

Mount oradatamnt (
 Critical = 0
 MountPoint = "/oradata"
 BlockDevice = "/dev/vx/dsk/oradatadg/datavol"
 FSType = vxfs
 FsckOpt = "-n"
)

Oracle oradb (
 Critical = 0
 Sid = vrts
 Owner = oracle
 Home = "/oracle/dbhome"
)
oradatamnt requires oradatadg
oradb requires oradatamnt

```

## Oracle initialization parameter file for Storage Foundation for Oracle HA

The sample Oracle initialization parameter file for Storage Foundation for Oracle HA is as follows:

```

vrts.__db_cache_size=1375731712
vrts.__java_pool_size=16777216
vrts.__large_pool_size=16777216
vrts.__oracle_base='/u02/app/oracle/product/11.2.0/dbhome_1'\
#ORACLE_BASE set from environment
vrts.__pga_aggregate_target=1224736768
vrts.__sga_target=1811939328
vrts.__shared_io_pool_size=0
vrts.__shared_pool_size=385875968
vrts.__streams_pool_size=0

```

```
*.audit_file_dest='/u02/app/oracle/product/11.2.0/dbhome_1\
/admin/vrts/adump'
*.audit_trail='none'
*.compatible='11.2.0.0.0'
*.control_files='/oradata/vrts/control01.ctl',
'/oradata/vrts/control02.ctl',
'/oradata/vrts/control03.ctl'
*.db_block_size=8192
*.db_domain=''
*.db_name='vrts'
*.diagnostic_dest='/u02/app/oracle/product/11.2.0/dbhome_1'
*.dispatchers='(PROTOCOL=TCP) (SERVICE=dbracXDB)'
*.log_archive_dest_1='LOCATION=/oradata/archive'
*.log_archive_format='%t_%s_%r.dbf'
*.memory_target=3036676096
*.open_cursors=300
*.processes=150
*.remote_login_passwordfile='EXCLUSIVE'
*.undo_tablespace='UNDOTBS1'
```

## tnsnames.ora for Storage Foundation for Oracle HA

The sample tnsnames.ora for Storage Foundation for Oracle HA is as follows:

```
Host : sys1
VRTS =
 (DESCRIPTION =
 (ADDRESS_LIST =
 (ADDRESS = (PROTOCOL = TCP) (HOST = sys1) (PORT = 1521))
)
 (CONNECT_DATA =
 (SERVICE_NAME = vrts)
)
)

Host : sys2
VRTS =
 (DESCRIPTION =
 (ADDRESS_LIST =
 (ADDRESS = (PROTOCOL = TCP) (HOST = sys2) (PORT = 1521))
)
 (CONNECT_DATA =
 (SERVICE_NAME = vrts)
)
)
```

```
)
)
```

## listener.ora for Storage Foundation for Oracle HA

The sample listener.ora for Storage Foundation for Oracle HA is as follows:

```
Host : sys1
```

```
LISTENER =
 (DESCRIPTION_LIST =
 (DESCRIPTION =
 (ADDRESS = (PROTOCOL = TCP) (HOST = sys1) (PORT = 1521))
 (ADDRESS = (PROTOCOL = IPC) (KEY = EXTPROC1521))
)
)
```

```
Host : sys2
```

```
LISTENER =
 (DESCRIPTION_LIST =
 (DESCRIPTION =
 (ADDRESS = (PROTOCOL = TCP) (HOST = sys2) (PORT = 1521))
 (ADDRESS = (PROTOCOL = IPC) (KEY = EXTPROC1521))
)
)
```

## VCS configuration file for SF Oracle RAC

The sample VCS configuration file for SF Oracle RAC is as follows:

```
include "OracleASMTTypes.cf"
include "types.cf"
include "CFSTypes.cf"
include "CRSResource.cf"
include "CVMTTypes.cf"
include "Db2udbTypes.cf"
include "MultiPrivNIC.cf"
include "OracleTypes.cf"
include "PrivNIC.cf"
include "SybaseTypes.cf"
```

```

cluster clus1 (
 UserNames = { admin = enoGniNkoJooMwoInl }
 Administrators = { admin }
 UseFence = SCSI3
 HacliUserLevel = COMMANDROOT
)

system sys1 (
)

system sys2 (
)

group ora_grp (
 SystemList = { sys1 = 0, sys2 = 1 }
 AutoFailOver = 0
 Parallel = 1
 AutoStartList = { sys1 , sys2 }
)

Oracle ora_res (
 Critical = 0
 Sid @sys1 = "vrts1"
 Sid @sys2 = "vrts2"
 Owner = oracle
 Home = "/u02/app/product/orabase/orahome"
 StartUpOpt = "SRVCTLSTART"
 ShutDownOpt = "SRVCTLSTOP"
)

CFSMount oradata_mnt (
 Critical = 0
 MountPoint = "/oradata"
 BlockDevice = "/dev/vx/dsk/oradatadg/oradatavol"
)

CVMVolDg oradata_voldg (
 Critical = 0
 CVMDiskGroup = oradatadg
 CVMVolume = { oradatavol }
 CVMActivation = sw
)

```



```
requires group cvm online local firm
ora_res requires oradata_mnt
oradata_mnt requires oradata_voldg
```

```
group cvm (
 SystemList = { sys1 = 0, sys2 = 1 }
 AutoFailOver = 0
 Parallel = 1
 AutoStartList = { sys1 , sys2 }
)

Application cssd (
 StartProgram = "/opt/VRTSvcs/rac/bin/cssd-online"
 StopProgram = "/opt/VRTSvcs/rac/bin/cssd-offline"
 CleanProgram = "/opt/VRTSvcs/rac/bin/cssd-clean"
 MonitorProgram = "/opt/VRTSvcs/rac/bin/cssd-monitor"
 OnlineRetryLimit = 20
 OnlineWaitLimit = 5
 Critical = 0
)

CFSfsckd vxfsckd (
)

CVMcluster cvm_clus (
 CVMClustName = clus1
 CVMNodeId = { sys1 = 0, sys2 = 1 }
 CVMTransport = gab
 CVMTimeout = 200
)

CFSMount ocrvote_mnt (
 Critical = 0
 MountPoint = "/ocrvote"
 BlockDevice = "/dev/vx/dsk/ocrvotedg/ocrvotevol"
)

CVMVolDg ocrvote_voldg (
 Critical = 0
 CVMDiskGroup = ocrvotedg
```

```
CVMVolume = { ocrvotevol }
CVMActivation = sw
)

CVMVxconfigd cvm_vxconfigd (
 CVMVxconfigdArgs = { syslog }
)

PrivNIC ora_priv (
 Critical = 0
 Device = { lan1 = 0, lan2 = 1 }
 Address @sys1 = "192.168.1.128"
 Address @sys2 = "192.168.1.131"
 NetMask = "255.255.255.0"
)

cssd requires ocrvote_mnt
cssd requires ora_priv
ocrvote_mnt requires ocrvote_voldg
ocrvote_voldg requires cvm_clus
ocrvote_mnt requires vxfsckd
vxfsckd requires cvm_clus
cvm_clus requires cvm_vxconfigd
```

## Oracle initialization parameter file for SF Oracle RAC

The sample Oracle initialization parameter file for SF Oracle RAC is as follows:

```
vrts2.__db_cache_size=331350016
vrts1.__db_cache_size=331350016
vrts2.__java_pool_size=4194304
vrts1.__java_pool_size=4194304
vrts2.__large_pool_size=4194304
vrts1.__large_pool_size=4194304
vrts2.__pga_aggregate_target=385875968
vrts1.__pga_aggregate_target=385875968
vrts2.__sga_target=578813952
vrts1.__sga_target=578813952
vrts2.__shared_io_pool_size=0
vrts1.__shared_io_pool_size=0
vrts2.__shared_pool_size=226492416
vrts1.__shared_pool_size=226492416
vrts2.__streams_pool_size=0
```

```

vrts1.__streams_pool_size=0
*.audit_file_dest='/u02/app/product/orabase/admin/vrts/adump'
*.audit_trail='db'
*.cluster_database=true
*.compatible='11.2.0.0.0'
*.control_files='/oradata/vrts/control01.ctl','/oradata/vrts/control02.ctl'
*.db_block_size=8192
*.db_domain=''
*.db_name='vrts'
*.diagnostic_dest='/u02/app/product/orabase'
*.dispatchers='(PROTOCOL=TCP) (SERVICE=vrtsXDB)'
vrts1.instance_number=1
vrts2.instance_number=2
*.memory_target=963641344
*.open_cursors=300
*.processes=150
*.remote_listener='cert-s
can-vip01:1521'
*.remote_login_passwordfile='exclusive'
vrts2.thread=2
vrts1.thread=1
vrts1.undo_tablespace='UNDOTBS1'
vrts2.undo_tablespace='UNDOTBS2'

```

## tnsnames.ora file for SF Oracle RAC

The sample tnsnames.ora file for SF Oracle RAC is as follows:

```

VRTS =
 (DESCRIPTION =
 (ADDRESS = (PROTOCOL = TCP) (HOST = scan-vip01) (PORT = 1521))
 (CONNECT_DATA =
 (SERVER = DEDICATED)
 (SERVICE_NAME = vrts)
)
)

```

## listener.ora file for SF Oracle RAC

The sample listener.ora file for SF Oracle RAC is as follows:

```

LIST1=(DESCRIPTION=(ADDRESS_LIST=(
 (ADDRESS=(PROTOCOL=IPC) (KEY=LIST1))))
ENABLE_GLOBAL_DYNAMIC_ENDPOINT_LIST1=ON

```

# Performing post-upgrade tasks

This chapter includes the following topics:

- [Relinking Oracle RAC libraries with the SF Oracle RAC libraries](#)
- [Setting or changing the product license level](#)
- [Upgrading disk layout versions](#)
- [Upgrading CVM protocol version and VxVM disk group version](#)
- [Post upgrade tasks for migrating the SFDB repository database](#)

## Relinking Oracle RAC libraries with the SF Oracle RAC libraries

You must relink the Oracle RAC libraries with the SF Oracle RAC libraries after upgrading SF Oracle RAC.

The steps vary depending on the version of Oracle RAC in use before the upgrade:

- If you upgraded from an SF Oracle RAC version running Oracle RAC 10g Release 2 or Oracle RAC 11g:  
See [“To relink Oracle RAC 10g Release 2 or Oracle RAC 11g using the installer”](#) on page 229.  
See [“Relinking the SF Oracle RAC libraries with Oracle RAC using the SF Oracle RAC Web-based installer”](#) on page 329.
- If you upgraded from an SF Oracle RAC version running Oracle RAC 9i or Oracle RAC 10g Release 1 or if you want to relink the libraries manually for later versions of Oracle RAC:

See [“To relink the Oracle RAC libraries with SF Oracle RAC libraries manually”](#) on page 230.

---

**Note:** You must upgrade the database to a supported version after you complete the post-upgrade tasks.

---

### To relink Oracle RAC 10g Release 2 or Oracle RAC 11g using the installer

**1** Run the `installsfrac` installer:

```
cd /opt/VRTS/install
./installsfrac<version> -configure sys1 sys2
```

Where `<version>` is the specific release version.

See [“About the Veritas installer”](#) on page 77.

**2** Select the option **Post Oracle Installation Tasks**.

```
1) Configure SF Oracle RAC sub-components
2) Prepare to Install Oracle
3) Install Oracle Clusterware/Grid Infrastructure and Database
4) Post Oracle Installation Tasks
5) Exit SF Oracle RAC Configuration
Choose option: [1-5,q] (1) 4
```

**3** Select the option **Relink Oracle Database Binary**.

```
1) Configure CSSD agent
2) Relink Oracle Database Binary
3) Exit SF Oracle RAC Configuration
b) Back to previous menu
Choose option: [1-3,b,q] (1) 2
```

**4 Provide the following information:**

```
Enter Oracle UNIX user name: [b] (oracle)
Enter Oracle UNIX group name: [b] (oinstall)
Enter absolute path of Oracle Clusterware/Grid Infrastructure
Home directory: [b]
Enter absolute path of Oracle Database Home directory: [b]
```

The installer detects the Oracle version.

**5 Enter y to proceed with relinking.**

```
Do you want to continue? [y,n,q] (y)
```

Perform the steps in the following procedure if you upgraded nodes running Oracle RAC 9i or Oracle RAC 10g Release 1 or if you want to relink the libraries manually.

**To relink the Oracle RAC libraries with SF Oracle RAC libraries manually**

**1 On each node, shut down the Oracle service group.**

If the service group is managed by VCS,

```
hagrps -offline oracle_grp -sys system_name
```

If the service group is not managed by VCS, then run the following on one node:

```
$ srvctl stop database -d db_name
```

**2 On each node, run the following commands as the oracle user to link Oracle with the Veritas IPC, VCSMM, and ODM libraries:**

```
$ export ORACLE_HOME=db_home
$ /opt/VRTSvcs/rac/bin/linkrac oracle_version
```

Replace oracle\_version with one of the following values depending on the version you installed:

- 9i (for Oracle RAC 9i)
- 10gR1 (for Oracle RAC 10g Release 1)
- 10gR2 (for Oracle RAC 10g Release 2)
- 11gR1 (for Oracle RAC 11g Release 1)
- 11gR2 (for Oracle RAC 11g Release 2)

---

**Note:** If the Oracle binaries are on a cluster file system, perform this step on only one node. If the Oracle binaries are on a local file system of each cluster node, run the command to link Oracle with Veritas libraries on each cluster node.

---

If your system uses a bundled C compiler or a compiler other than the ANSI C compiler, you can safely ignore such warnings as:

```
(Bundled) cc: warning 922: "+Oshortdata=8" is unsupported in the
bundled compiler, ignored.
```

Refer to Oracle Metalink Document ID 66442.1 for more information.

Search on: 66442.1 FAQ about C Compiler Issues on HP-UX.

- 3 On each node, start the Oracle service group:

```
hagrps -online oracle_grp -sys system_name
```

- 4 After starting the Oracle instance, confirm Oracle uses the Veritas libraries. Examine the Oracle alert file, `alert_${ORACLE_SID}.log`, for the following lines:

```
Oracle instance running with ODM: VERITAS 6.0 ODM Library,
Version 2.0
```

Additionally, for Oracle RAC 10g, verify that the cluster interconnect IPC version is VERITAS IPC 6.0.100.000.

---

**Note:** If Oracle binaries are on a local file system of each cluster node, examine the Oracle alert file on each of the cluster nodes.

---

If you see the following message in the `alert_${ORACLE_SID}.log` file

```
cluster interconnect IPC version string is not available
Oracle interface version information 2.4
cluster IPC library version information 2.2
```

Perform the following steps:

- Stop the database on all the nodes (for instances under VCS control):

```
hagrps -offline oracle_grp -sys system_name
```

Stop the database on all the nodes (for instances not under VCS control):

```
srvctl stop database -d database_name
```

- For Oracle RAC 9i/Oracle RAC 10g Release 1: Export the `IPC_LIB_PATH` variable:

On HP-UX (IA) for Oracle RAC 9i:

```
$ export IPC_LIB_PATH=/opt/VRTSvcs/rac/lib/hpux64/\
libskgxp<oracleversion>_ver24_64.so
```

On HP-UX (IA) for Oracle RAC 10g Release 1:

```
$ export IPC_LIB_PATH=/opt/VRTSvcs/rac/lib/hpux64/\
libskgxp<oracleversion>_ver25_64.so
```

where *<oracleversion>* is 9 (for Oracle RAC 9i) or 10 (for Oracle RAC 10g)

- Repeat step 2 and step 3.

## Setting or changing the product license level

If you upgrade to this release from a previous release of the Veritas software, the product installer does not change the license keys that are already installed. The existing license keys may not activate new features in this release.

After you upgrade, perform one of the following steps:

- Obtain a valid license key and run the `vxlicinst` command to add it to your system.
- Use the `vxkeyless` command to update the license keys to the keyless license model.

For more information and instructions, see the chapter *Licensing SF Oracle RAC*.

## Upgrading disk layout versions

After you upgrade to SF Oracle RAC 6.0.1, upgrade the disk layout version to a supported version for non-system mount points. You can use the `vxupgrade` or `vxfsconvert` utilities to upgrade older disk layout versions to disk layout version 7 or later.

SF Oracle RAC 6.0.1 supports disk layouts Versions 5, 7, or later for locally mounted file systems and disk layouts versions 7 or later for cluster mounted file systems. If you have cluster mounted file systems with disk layout versions lower than 7, then perform the following additional steps to upgrade the disk layout version for non-system mount points.



---

**Warning:** Do not upgrade the / and /stand file systems to disk layout version 6 or later. The HP-UX bootloader does not support disk layout versions other than version 5.

---

**To upgrade the disk layout versions**

- 1 Select one of the nodes of the cluster and `mount` the file system locally on this node. For example, mount it without the `-o cluster` option. Enter,

```
mount -F vxfs block_device_path /mnt1
```

- 2 Current disk layout version on a file system can be found using

```
fstyp -v char_device_path | grep version | \
 awk '{print $2}'
```

- 3 On the node selected in 1, incrementally upgrade the disk layout of this file system to disk layout version 7 or later. For example, if you had a cluster mounted file system of disk layout version 7, after upgrading to SF Oracle RAC 6.0.1, you would upgrade the disk layout to version 9 incrementally as follows:

```
vxupgrade -n 7 /mnt1
vxupgrade -n 8 /mnt1
vxupgrade -n 9 /mnt1
```

- 4 On the node selected in 1, after the disk layout has been successfully upgraded, unmount the file system.

```
umount /mnt1
```

This file system can be mounted on all nodes of the cluster using `cfsmount`.

For more information about disk layout versions, see the *Veritas Storage Foundation Administrator's Guide*.

## Upgrading CVM protocol version and VxVM disk group version

The default Cluster Volume Manager protocol version is 120.

Run the following command to verify the CVM protocol version:

```
/opt/VRTS/bin/vxdctl protocolversion
```

If the protocol version is not 120, run the following command to upgrade the version:

```
/opt/VRTS/bin/vxdctl upgrade
```

All Veritas Volume Manager disk groups have an associated version number. Each VxVM release supports a specific set of disk group versions and can import and perform tasks on disk groups with those versions. Some new features and tasks work only on disk groups with the current disk group version. Before you can perform the tasks, you need to upgrade existing disk group version to 180.

Check the existing disk group version:

```
vxdg list dg_name | grep -i version
```

If the disk group version is not 180, run the following command on the master node to upgrade the version:

```
vxdg -T 180 upgrade dg_name
```

## Post upgrade tasks for migrating the SFDB repository database

Database Storage Checkpoints that have been created by using the SFDB tools before upgrade are visible using the `vxsfadm` CLI, and you can mount these Database Storage Checkpoints and roll back to them, if required. However, creating clones by using migrated Database Storage Checkpoints is not supported.

If you want to continue using previously created FlashSnap snapplans to take snapshots, you must validate them by using the `-o validate` option of the `vxsfadm` command.

To continue using the Database Storage Checkpoints or SmartTier for Oracle policies you created with a 5.0x or earlier version of Storage Foundation for Oracle RAC, you must perform one of the following procedures after upgrading SF Oracle RAC to 6.0.1:

- Rename startup script after upgrading from 5.0x and before migrating the SFDB repository  
See [“After upgrading from 5.0.x and before migrating SFDB”](#) on page 239.
- Migrate from a 5.0x SFDB repository database to 6.0.1  
See [“Migrating from a 5.0 repository database to 6.0.1”](#) on page 235.
- Migrate from a 5.1 or 5.1SP1 repository database to 6.0.1  
See [“Migrating from a 5.1 or higher repository database to 6.0.1”](#) on page 237.

## Migrating from a 5.0 repository database to 6.0.1

Perform the following on one node only.

### To migrate from a 5.0 repository database to 6.0.1

- 1 Rename the startup script NO\_S\*vxdbms3 to S\*vxdbms3.

See “[After upgrading from 5.0.x and before migrating SFDB](#)” on page 239.

- 2 As root, dump out the old Sybase ASA repository. If you are using SFHA or SF Oracle RAC, you only need to do this on one node.

```
/opt/VRTSdbed/migrate/sfua_rept_migrate
```

- 3 On the same node that you ran `sfua_rept_migrate` run the following command as Oracle user. For each Oracle instance, migrate the old repository data to the SQLite repository.
- 4 By default, the repository is created on the file system which contains the Oracle SYSTEM tablespace. If you need an alternative repository path, first verify the following requirements:
  - Repository path has to be a directory writable by Oracle user.
  - The repository must be accessible by all nodes. You can put it in a CFS file system, or put it in a resource group under VCS control so it can be failed over together with the Oracle database.
  - The update commands will not be able to verify accessibility of the repository path and will fail if you have not set up the path correctly.

Create an alternate repository path.

- 5 If you are using Database Flashsnap for off-host processing, and if you have a repository on the secondary host that you need to migrate: perform the previous steps on the secondary host.

- 6 On the primary host, edit your snapplans to remove the "SNAPSHOT\_DG=SNAP\_\*" parameter and add "SNAPSHOT\_DG\_PREFIX=SNAP\_\*". The parameter can be any PREFIX value and not necessarily "SNAP\_\*".

For example:

```
$ /usr/oracle> more SNAPPLAN1
SNAPSHOT_VERSION=5.0
PRIMARY_HOST=system1
SECONDARY_HOST=system1.example.com
PRIMARY_DG=system1_data
SNAPSHOT_DG=SNAP_system1_data
ORACLE_SID=HN1
ARCHIVELOG_DEST=/oracle/orahome/dbs/arch
SNAPSHOT_ARCHIVE_LOG=yes
SNAPSHOT_MODE=online
SNAPSHOT_PLAN_FOR=database
SNAPSHOT_PLEX_TAG=dbed_flashsnap
SNAPSHOT_VOL_PREFIX=SNAP_
ALLOW_REVERSE_RESYNC=no
SNAPSHOT_MIRROR=1
```

```
$ /usr/oracle> more SNAPPLAN1
SNAPSHOT_VERSION=5.0
PRIMARY_HOST=system1
SECONDARY_HOST=system1.example.com
PRIMARY_DG=judge_data
SNAPSHOT_DG_PREFIX=SNAP_system1_data
ORACLE_SID=HN1
ARCHIVELOG_DEST=/oracle/orahome/dbs/arch
SNAPSHOT_ARCHIVE_LOG=yes
SNAPSHOT_MODE=online
SNAPSHOT_PLAN_FOR=database
SNAPSHOT_PLEX_TAG=dbed_flashsnap
SNAPSHOT_VOL_PREFIX=SNAP_
ALLOW_REVERSE_RESYNC=no
SNAPSHOT_MIRROR=1
```

- 7 On the primary host, revalidate your snapshots using the following command:

```
$ /opt/VRTS/bin/vxsfadm -s flashsnap \
-a oracle -c SNAPPLAN -o validate
```

This completes the migration of the repository for Database Storage Checkpoints and Database Tiered Storage parameters.

To begin using the Storage Foundation for Databases (SFDB) tools:

See *Storage Foundation: Storage and Availability Management for Oracle Databases*

## Migrating from a 5.1 or higher repository database to 6.0.1

Perform the following on one node only.

### To migrate from a 5.0 repository database to 6.0.1

- 1 Run the following command as Oracle user. For each Oracle instance, migrate the old repository data to the SQLite repository.

```
$ /opt/VRTS/bin/dbed_update -S $ORACLE_SID -H $ORACLE_HOME
```

- 2 By default, the repository is created on the file system which contains the Oracle SYSTEM tablespace. If you need an alternative repository path, first verify the following requirements:

- Repository path has to be a directory writable by Oracle user.
- The repository must be accessible by all nodes. You can put it in a CFS file system, or put it in a resource group under VCS control so it can be failed over together with the Oracle database.
- The update commands will not be able to verify accessibility of the repository path and will fail if you have not set up the path correctly.

Create an alternate repository path.

- 3 If you are using Database Flashsnap for off-host processing, and if you have a repository on the secondary host that you need to migrate: perform the previous steps on the secondary host.

- 4 On the primary host, edit your snapplans to remove the "SNAPSHOT\_DG=SNAP\_\*" parameter and add "SNAPSHOT\_DG\_PREFIX=SNAP\_\*". The parameter can be any PREFIX value and not necessarily "SNAP\_\*".

For example:

```
$ /usr/oracle> more SNAPPLAN1
SNAPSHOT_VERSION=5.0
PRIMARY_HOST=system1
SECONDARY_HOST=system1.example.com
PRIMARY_DG=system1_data
SNAPSHOT_DG=SNAP_system1_data
ORACLE_SID=HN1
ARCHIVELOG_DEST=/oracle/orahome/dbs/arch
SNAPSHOT_ARCHIVE_LOG=yes
SNAPSHOT_MODE=online
SNAPSHOT_PLAN_FOR=database
SNAPSHOT_PLEX_TAG=dbed_flashsnap
SNAPSHOT_VOL_PREFIX=SNAP_
ALLOW_REVERSE_RESYNC=no
SNAPSHOT_MIRROR=1
```

```
$ /usr/oracle> more SNAPPLAN1
SNAPSHOT_VERSION=5.0
PRIMARY_HOST=system1
SECONDARY_HOST=system1.example.com
PRIMARY_DG=judge_data
SNAPSHOT_DG_PREFIX=SNAP_system1_data
ORACLE_SID=HN1
ARCHIVELOG_DEST=/oracle/orahome/dbs/arch
SNAPSHOT_ARCHIVE_LOG=yes
SNAPSHOT_MODE=online
SNAPSHOT_PLAN_FOR=database
SNAPSHOT_PLEX_TAG=dbed_flashsnap
SNAPSHOT_VOL_PREFIX=SNAP_
ALLOW_REVERSE_RESYNC=no
SNAPSHOT_MIRROR=1
```

5 On the primary host, revalidate your snapshots using the following command:

```
$ /opt/VRTS/bin/vxsfadm -s flashsnap \
-a oracle -c SNAPPLAN -o validate
```

This completes the migration of the repository for Database Storage Checkpoints and Database Tiered Storage parameters.

To begin using the Storage Foundation for Databases (SFDB) tools:

See *Storage Foundation: Storage and Availability Management for Oracle Databases*

## After upgrading from 5.0.x and before migrating SFDB

When upgrading from SF Oracle RAC version 5.0 or 5.0.1 to SF Oracle RAC 6.0.1 the S\*vxdms3 startup script is renamed to NO\_S\*vxdms3. The S\*vxdms3 startup script is required by `sfua_rept_migrate`. Thus when `sfua_rept_migrate` is run, it is unable to find the S\*vxdms3 startup script and gives the error message:

```
/sbin/rc3.d/S*vxdms3 not found
SFORA sfua_rept_migrate ERROR V-81-3558 File: is missing.
SFORA sfua_rept_migrate ERROR V-81-9160 Failed to mount repository.
```

### To prevent S\*vxdms3 startup script error

- ◆ Rename the startup script NO\_S\*vxdms3 to S\*vxdms3.

This permission change must be done before executing SFDB upgrade commands.

# Installation and upgrade of Oracle RAC

- [Chapter 21. Before installing Oracle RAC](#)
- [Chapter 22. Installing Oracle RAC](#)
- [Chapter 23. Performing Oracle RAC post-installation tasks](#)
- [Chapter 24. Upgrading Oracle RAC](#)



# Before installing Oracle RAC

This chapter includes the following topics:

- [Important preinstallation information for Oracle RAC](#)
- [About preparing to install Oracle RAC](#)
- [Preparing to install Oracle RAC using the SF Oracle RAC installer or manually](#)

## Important preinstallation information for Oracle RAC

Before you install Oracle RAC, ensure that you meet the following requirements:

- Review the Oracle documentation for additional requirements pertaining to your version of Oracle.
- Keep the Oracle worksheets handy with the values appropriate for your installation setup.

See [“Oracle RAC worksheet”](#) on page 530.

---

**Note:** The manual procedures use variables, which are indicated by *italicized* text. Ensure that you replace these variables with actual values.

---

## About preparing to install Oracle RAC

Use one of the following ways to perform the pre-installation tasks:

## Preparing to install Oracle RAC using the SF Oracle RAC installer or manually

|                         |                                                                                                                                                                                                                                                                                                                                                                                                                                                                                                                                     |
|-------------------------|-------------------------------------------------------------------------------------------------------------------------------------------------------------------------------------------------------------------------------------------------------------------------------------------------------------------------------------------------------------------------------------------------------------------------------------------------------------------------------------------------------------------------------------|
| SF Oracle RAC installer | <p>The SF Oracle RAC installer provides a menu-driven command line interface to step you through the pre-installation tasks.</p> <p><b>Note:</b> Some of the pre-installation steps are not supported by the SF Oracle RAC installer and must be done manually as described in the manual procedures.</p>                                                                                                                                                                                                                           |
| Manual                  | <p>You need to perform the pre-installation tasks manually as described in the manual procedures.</p>                                                                                                                                                                                                                                                                                                                                                                                                                               |
| Response file           | <p>You can pre-configure the systems for Oracle RAC installation using an SF Oracle RAC response file. The SF Oracle RAC response file in tandem with the Oracle RAC response files simplify the process of automating and standardizing Oracle RAC installations.</p> <p><b>Note:</b> You can use the response file to automate only those pre-configuration tasks that are supported by the SF Oracle RAC installer.</p> <p>For instructions, see the chapter "Installing Oracle RAC using a response file" in this document.</p> |

The examples in this chapter assume a two-node cluster comprising the nodes sys1 and sys2.

Before installing Oracle RAC, review the Oracle installation manuals and the appropriate Oracle support Web sites. Some of the pre-installation tasks, wherever indicated in the document, must be done in accordance with the instructions in the Oracle installation manuals. The instructions for these tasks are not provided in this document.

---

**Note:** The instructions in this chapter use variables and sample values wherever required. Replace these variables and sample values with values that conform to your installation requirements.

Before you start the preparatory tasks, you may want to update the sample worksheet with the correct installation values and keep them handy during the process.

---

## Preparing to install Oracle RAC using the SF Oracle RAC installer or manually

This section provides instructions for both manual as well as SF Oracle RAC installer-based procedures.

### To prepare to install Oracle RAC

- 1 Identify the public virtual IP addresses for use by Oracle.  
See [“Identifying the public virtual IP addresses for use by Oracle”](#) on page 244.
- 2 Set the kernel parameters.  
See [“Setting the kernel parameters”](#) on page 244.
- 3 Verify that depots and patches required by Oracle are installed.  
See [“Verifying that depots and patches required by Oracle are installed”](#) on page 245.
- 4 Verify that the user `nobody` exists.  
See [“Verifying the user `nobody` exists”](#) on page 245.
- 5 Launch the SF Oracle RAC installer.  
See [“Launching the SF Oracle RAC installer”](#) on page 245.
- 6 Create Oracle user and groups.  
See [“Creating users and groups for Oracle RAC”](#) on page 247.
- 7 Create the storage for OCR and voting disk.  
See [“Creating storage for OCR and voting disk ”](#) on page 252.
- 8 Configure the private network for Oracle RAC.  
See [“Configuring private IP addresses for Oracle RAC”](#) on page 269.
- 9 For Oracle RAC 11g Release 2: Verify that multicast is functional on all private network interfaces.  
See [“Verifying that multicast is functional on all private network interfaces”](#) on page 288.
- 10 Create the Oracle Clusterware/Grid Infrastructure and Oracle database home directories manually.  
See [“Creating Oracle Clusterware/Grid Infrastructure and Oracle database home directories manually”](#) on page 289.
- 11 Set up Oracle user equivalence on all nodes.  
See [“Setting up user equivalence”](#) on page 298.
- 12 Set privileges for the DBA user.  
See [“Setting privileges for the DBA group”](#) on page 298.

## Identifying the public virtual IP addresses for use by Oracle

Identify separate public virtual IP addresses for each node in the cluster. Oracle requires one public virtual IP address for the Oracle listener process on each node. Public virtual IP addresses are used by client applications to connect to the Oracle database. Oracle Clusterware/Grid Infrastructure manages the virtual IP addresses.

The IP address and the corresponding host name should be registered in the domain name service (DNS). Alternatively, an entry for the virtual IP address and virtual public name can be placed in the `/etc/hosts` file as shown in the following example:

```
10.182.79.239 sys1-vip
10.182.79.240 sys2-vip
```

The `/etc/hosts` file on each node of the cluster should have these entries.

Oracle recommends that the public node name for the virtual IP address be in the following format `hostname-vip`. For example, `sys1-vip`.

---

**Note:** The public node name (in other words, the alias for the virtual IP address) for the nodes must be different from the host's current fully qualified domain name (FQDN).

---

For Oracle RAC 11g Release 2: Additionally, you need a Single Client Access Name (SCAN) registered in Enterprise DNS that resolves to three IP addresses (recommended) using a round robin algorithm or at least one IP address. The IP addresses must be on the same subnet as your public network in the cluster. SCAN provides a single name for clients to access an Oracle database running in a cluster.

---

**Note:** The virtual IP addresses that are used for SCAN IP resolution must be on the same subnet. Oracle RAC does not support their configuration on different subnets.

---

## Setting the kernel parameters

Set the kernel parameter values to meet Oracle RAC deployment requirements. The Oracle Universal Installer (OUI) verifies the settings at the time of installation to ensure that they satisfy the minimum requirements. The Oracle RAC installation fails if the kernel parameters are not configured properly. The settings can also be tuned to optimize system performance.

For instructions and guidelines, see the Oracle Metalink document: 169706.1

Restart the nodes for the new values to take effect.

## Verifying that depots and patches required by Oracle are installed

Oracle may require certain depots and patches to be installed before the installation of Oracle RAC.

For the list of depots and patches and related instructions, see the Oracle documentation.

## Verifying the user `nobody` exists

To verify the user "nobody" exists on each system in the cluster:

```
id nobody
uid=65534(nobody) gid=65533(nobody) groups=65533(nobody),65534(nogroup)
```

If the user does not exist, create the user:

```
groupadd -g 65533 nobody
useradd -g 65533 -u 65533 nobody
```

---

**Note:** Make sure that the user ID and group ID are the same across the nodes in your cluster.

---

## Launching the SF Oracle RAC installer

You can use one of the following ways to launch the SF Oracle RAC installer:

- Veritas script-based installation program  
See [“To launch the SF Oracle RAC script-based installer”](#) on page 246.
- Veritas Web-based installation program  
See [“To launch the SF Oracle RAC Web-based installer”](#) on page 246.

### To launch the SF Oracle RAC script-based installer

- 1 Log in as the root user on any one node and start the SF Oracle RAC script-based installer:

```
cd /opt/VRTS/install
./installsfrac<version> -configure sys1 sys2
```

Where <version> is the specific release version.

See [“About the Veritas installer”](#) on page 77.

The program displays the Symantec copyright information as well as the location of the installation logs.

- 2 Review the installer instructions and press **Enter** to proceed. From the configuration program menu, select **Prepare to Install Oracle**.
- 3 Select the pre-installation task you want to perform.
  - Enter **1** to select the option **Create Oracle Users and Groups**:  
See [“Creating users and groups for Oracle RAC”](#) on page 247.
  - Enter **2** to select the option **Create Storage for OCR and voting disk**:  
See [“Creating storage for OCR and voting disk ”](#) on page 252.
  - Enter **3** to select the option **Oracle Network Configuration**:  
See [“Configuring private IP addresses for Oracle RAC”](#) on page 269.

### To launch the SF Oracle RAC Web-based installer

- 1 Start the Web-based installer.  
See [“Starting the Veritas Web-based installer”](#) on page 122.
- 2 Select **Configure a Product** from the Task drop-down list.
- 3 Select **Veritas Storage Foundation for Oracle RAC** from the Product drop-down list.
- 4 Enter the system names in the System Names text box and click **Validate**.  
The installer performs system verification checks. Click **Next** after the verification completes.
- 5 Select **Prepare to install Oracle** from the Select a Task drop-down list. Click **Next**.
- 6 Select the pre-installation task you want to perform.
  - Select the option **Create Oracle Users and Groups** to create Oracle user and group.  
See [“Creating users and groups for Oracle RAC”](#) on page 247.

- Select the option **Create Storage for OCR and voting disk** to create the storage for OCR and voting disk.  
See [“Creating storage for OCR and voting disk”](#) on page 252.
- Select the option **Oracle Network Configuration** to configure the private IP addresses for Oracle RAC.  
See [“Configuring private IP addresses for Oracle RAC”](#) on page 269.

## Creating users and groups for Oracle RAC

Depending on the Oracle RAC version, create the required users and groups.

Create the following groups and users for Oracle RAC 10g Release 2/ Oracle RAC 11g Release 1:

- Oracle Inventory group
- dba group
- Oracle user

Create the following groups and users for Oracle RAC 11g Release 2:

- Oracle Inventory group
- dba group
- Oracle grid user
- Oracle user

Create additional users and groups as required by Oracle. Before creating Oracle users and groups, see the Oracle documentation.

You must assign Oracle Inventory as the primary group and dba as the secondary group. Oracle requires secondary groups for identifying operating system accounts that have database administrative (SYSDBA) privileges and for those accounts that have limited sets of database administrative (SYSOPER) privileges. Create the groups on all systems and assign the Oracle user to these groups.

Use one of the following ways to create the Oracle user and groups:

- |                                                |                                                                                                                       |
|------------------------------------------------|-----------------------------------------------------------------------------------------------------------------------|
| Using the SF Oracle RAC script-based installer | See <a href="#">“Creating the Oracle user and groups using the SF Oracle RAC script-based installer”</a> on page 248. |
| Using the SF Oracle RAC Web-based installer    | See <a href="#">“Creating the Oracle user and groups using the SF Oracle RAC Web-based installer”</a> on page 249.    |
| Manual                                         | See <a href="#">“Creating the Oracle user and groups manually”</a> on page 251.                                       |

## Creating the Oracle user and groups using the SF Oracle RAC script-based installer

This procedure provides instructions for creating the Oracle user and groups using the SF Oracle RAC installer.

### To create the Oracle user and groups on all nodes in the cluster

- 1 From the SF Oracle RAC installer menu, enter **1** to select the option **Create Oracle Users and Groups**.
- 2 Provide the following information for creating the Oracle user and groups: user name, group name, user ID, group ID, and the full path of the Oracle user home directory.

The user ID and group ID must not be in use on any node in the cluster. The installer suggests unused values, which you may use or change as required. The configuration program assigns the same values on all the nodes.

---

**Note:** If you are configuring GCO, then the user IDs and group IDs of all nodes on both the primary and secondary clusters must be the same. While configuring the user ID and group ID values on the secondary site, make sure that they are identical to the values used at the primary site.

---

For Oracle RAC 10g Release 2/Oracle RAC 11g Release 1:

```
Enter Oracle UNIX user name: [b] oracle
Enter Oracle user's ID (numerical): [b] (1165)
Enter Oracle UNIX group name: [b] oinstall
Enter Oracle group's ID (numerical): [b] (1165)
Enter absolute path of Oracle user's Home directory: [b] /home/oracle
Is this information correct? [y,n,q] (y)
```

Review and confirm the information provided.

- 3 For Oracle RAC 11g Release 2:

Repeat the above steps to create the grid user.

```
Enter Oracle UNIX user name: [b] grid
Enter Oracle user's ID (numerical): [b] (1168)
Enter Oracle UNIX group name: [b] (oinstall)
Enter Oracle group's ID (numerical): [b] (1000)
Enter absolute path of Oracle user's Home directory: [b] /home/grid
```



- 4 Enter the information to create secondary groups, "dba" and "oper".

The secondary group "oper" is optional.

```
Do you want to create a secondary group
for Oracle user? [y,n,q,b,?] (n) y
Enter Oracle UNIX group name: [b] (dba, oper etc.)
Enter Oracle group's ID (numerical): [b] (1996)
```

```
Creating secondary group dba for
Oracle user oracle on sys1 Done
Creating secondary group dba for
Oracle user oracle on sys2 Done
Do you want to create another secondary group
for Oracle user? [y,n,q,b,?] (n)
```

- 5 Create a password for the oracle user on each node.

```
passwd oracle
```

- 6 Set up passwordless SSH as the oracle/grid user to install Oracle RAC binaries.

For instructions, see the appendix *Setting up inter-system communication* in this document.

## **Creating the Oracle user and groups using the SF Oracle RAC Web-based installer**

This procedure provides instructions for creating the Oracle user and groups using the SF Oracle RAC Web-based installer.

**To create the Oracle user and groups on all nodes in the cluster**

- 1 From the SF Oracle RAC installer menu, select the option **Create Oracle User and Group**.
- 2 Provide the following information for creating the Oracle user and groups: user name, group name, user ID, group ID, and the full path of the Oracle user home directory.

The user ID and group ID must not be in use on any node in the cluster. The installer suggests unused values, which you may use or change as required. The configuration program assigns the same values on all the nodes.

---

**Note:** If you are configuring GCO, then the user IDs and group IDs of all nodes on both the primary and secondary clusters must be the same. While configuring the user ID and group ID values on the secondary site, make sure that they are identical to the values used at the primary site.

---

```
Enter Oracle UNIX user name:
Enter Oracle UNIX group name:
Enter Oracle user's ID (numerical) (1165):
Enter Oracle group's ID (numerical) (1165):
Enter absolute path of Oracle user's Home directory:
```

- 3 Click **Yes** at the confirmation prompts.
- 4 Click **Yes** to enter the information to create secondary groups, "dba" and "oper".  
The secondary group "oper" is optional.

```
Enter Oracle UNIX secondary group name:
Enter Oracle group's ID (numerical) (1996):
```

- 5 Click **Ok** to confirm.
- 6 Click **Yes** if you want to create another secondary group, else click **No**.

- 7 Create a password for the oracle user on each node:

```
passwd oracle
```

- 8 For Oracle RAC 11g Release 2: Repeat the above steps to create the grid user.

```
Enter Oracle UNIX user name:
Enter Oracle UNIX group name (oinstall):
Enter Oracle user's ID (numerical) (1168):
Enter Oracle group's ID (numerical) (1000):
Enter absolute path of Oracle user's Home directory:
```

## Creating the Oracle user and groups manually

Perform this step only if you plan to configure the database storage management repository during the configuration of SF Oracle RAC.

Depending on the Oracle RAC version, create the necessary Oracle groups and users. Be sure to assign the same group ID, user ID, and home directory for the user on each system.

---

**Note:** When you create the user and group, make sure that you specify a user and group ID that is not in use.

---

### To create the operating system Oracle user and group on each system

- 1 Create the primary and secondary group on each system.

Primary group:

```
groupadd -g grp_id grp_name
```

Secondary group:

```
groupadd -g grp_id_sec grp_name_sec
```

- 2 Create the Oracle user and the user home directory on each system:

```
useradd -g grp_name -u user_id \
-G grp_name_sec -m -d user_home user_name
```

## Creating storage for OCR and voting disk

Create appropriate storage for Oracle Cluster Registry (OCR) and the voting disk depending on the version of Oracle RAC.

|                          |                                                                                                       |
|--------------------------|-------------------------------------------------------------------------------------------------------|
| Oracle RAC 10g Release 2 | The OCR and the voting disk can reside on CVM raw volumes or in directories in a cluster file system. |
| Oracle RAC 11g Release 2 | The OCR and the voting disk can reside on ASM or in directories in a cluster file system.             |
|                          | <b>Note:</b> You can use CVM raw volumes to create ASM disk groups.                                   |

Use one of the following ways to create the storage:

|                                      |                                                                                                                            |
|--------------------------------------|----------------------------------------------------------------------------------------------------------------------------|
| SF Oracle RAC script-based installer | See <a href="#">“Creating storage for OCR and voting disk using the SF Oracle RAC script-based installer”</a> on page 252. |
| SF Oracle RAC Web-based installer    | See <a href="#">“Creating storage for OCR and voting disk using the SF Oracle RAC Web-based installer”</a> on page 257.    |
| Manual                               | See <a href="#">“Creating storage for OCR and voting disk manually”</a> on page 263.                                       |

You need to create CVM volumes or a CFS mount point for database file storage later in the installation process:

See [“Creating the Oracle RAC database”](#) on page 331.

### Creating storage for OCR and voting disk using the SF Oracle RAC script-based installer

The SF Oracle RAC installer enables you to create OCR and voting disk storage on CVM raw volumes or on a clustered file system. After creating the storage, the installer adds the storage configuration to VCS for high availability.

If you are creating the OCR and voting disk storage on CVM raw volumes, the installer performs the following tasks:

- Creates CVM volumes for OCR and voting disk (two-way mirrored or unmirrored)
- Creates the OCR and voting disk volumes and sets the ownership
- Starts the volumes
- Adds the CVMVolDg resource to the VCS configuration in the cvm group so that the volumes are brought online automatically when the node starts
- Brings the CVMVolDg resource online

If you are creating the OCR and voting disk storage on CFS, the installer performs the following tasks:

- Creates CVM volumes for OCR and voting disk (two-way mirrored or unmirrored)
- Creates the OCR and voting disk volumes and sets the ownership
- Starts the volumes
- Creates the mount point and mounts it on all the nodes
- Sets the ownership for the CFS mount point
- Adds the CFSSMount and CVMVolDg resources to the VCS configuration in the cvm group so that the resources are brought online automatically when the nodes start
- Brings the CFSSMount and CVMVolDg resources online

**To create storage for OCR and voting disk using the SF Oracle RAC installer**

- 1** From the SF Oracle RAC installer menu, enter **2** to select the option **Create Storage for OCR and Voting disk**.

The following menu displays:

```

1) Create Oracle Users and Groups
2) Create Storage for OCR and Voting disk
3) Oracle Network Configuration
4) Exit SF Oracle RAC Configuration
b) Back to previous menu
Choose option: [1-4,b,q] (1) 2

```

- 2** Enter **y** to create the storage.

```

Do you want the installer to assist you in creating disk groups,
volumes and file systems for Oracle? [y,n,q] (n) y

```

If you want to create the storage manually, enter **n**. The installer displays instructions for creating the storage manually. You may skip the remaining steps.

- 3** Select an appropriate option for the disk group.

```

1) Create a disk group
2) Use an existing disk group
b) Back to previous menu
Choose option: [1-2,b,q]

```

If you want to mirror the CVM volumes, click **Yes** at the following prompt:

Do you want to enable mirroring? [y,n,q] (y) y

- If you choose to create a disk group, the installer displays the list of existing disks that do not belong to any disk group. Specify the disk (by entering the serial numbers displayed next to the disk name) that you want to use to create the disk group. If you chose to mirror the CVM volumes, select at least two disks.

Enter the name of the disk group.

Enter the disk group name: [b] (ocrvotedg)

- If you choose to use an existing disk group, the installer displays the list of existing disk groups. Select a disk group. If you chose to mirror the CVM volumes, select an existing disk group that contains at least two disks for mirroring.

#### 4 Review and confirm the configuration information displayed:

```
CVM Master node: sys1
Selected disks (including mirroring):
 1. Disk_2
 2. Disk_3
Disk group name: ocrvotedg
Is this information correct? [y,n,q] (y)
```

The installer initializes the disk groups.

#### 5 Choose the type of storage.

- To create the storage on CVM raw volumes:  
See [“Creating the OCR and voting disk storage on CVM raw volumes”](#) on page 254.
- To create the storage on CFS:  
See [“Creating the OCR and voting disk storage on CFS”](#) on page 255.

### Creating the OCR and voting disk storage on CVM raw volumes

Perform the steps in the following procedure to create the storage for OCR and voting disk on CVM raw volumes.

---

**Note:** For Oracle RAC 11g Release 2, you may create CVM raw volumes to create ASM disk groups that may be used to store the OCR and voting disk information.

---

**To create the OCR and voting disk storage on CVM raw volumes**

- 1** Enter **1** to select the option **CVM Raw Volume**.

```

1 CVM Raw Volume
2 Clustered File System
b Back to previous menu
Select the storage scheme to be used: [1-2,b,q] 1

```

- 2** Enter the name and size of the volume on which you want to store OCR information.

```

Enter the volume name for OCR: [b] (ocrvol)
Enter the volume size for OCR (in MB): [b] (320)

```

- 3** Enter the name and size of the volume on which you want to store voting disk information.

```

Enter the volume name for Vote: [b] (votevol)
Enter the volume size for Vote (in MB): [b] (320)

```

- 4** Enter the Oracle UNIX user name.

```

Enter Oracle UNIX user name: [b] oracle

```

- 5** Enter the Oracle UNIX group name.

```

Enter Oracle UNIX group name: [b] (oinstall)

```

- 6** Press **Return** to continue.

- 7** Review and confirm the configuration information. The installer creates the volumes and brings the corresponding resources online.

Press **Return** to continue.

- 8** Verify that the corresponding resource is online on all nodes in the cluster.

---

**Note:** It takes a few minutes for the CVMVolDg resource to come online.

---

```
hares -state ocrvotevol_resname
```

**Creating the OCR and voting disk storage on CFS**

Perform the steps in the following procedure to create the storage for OCR and voting disk on CFS.

**To create the OCR and voting disk storage on CFS**

**1 Enter 2 to select the option **Clustered File System**.**

```

1 CVM Raw Volume
2 Clustered File System
b Back to previous menu
Select the storage scheme to be used: [1-2,b,q] 2

```

**2 Specify whether you want to create separate file systems for OCR and voting disk:**

```

Do you want to create separate filesystems for ocr and vote?
[y,n,q] (y)

```

**3 Enter the name and size of the volume on which you want to store OCR and voting disk information.**

- If you have chosen to create a shared file system for OCR and voting disk, enter the following information:

```

Enter the volume name for OCR and Voting disk:
[b] (ocrvotevol)
Enter the volume size for OCR and Voting disk (in MB):
[b] (640)

```

- If you have chosen to create separate file systems for OCR and voting disk, enter the following information:

```

Enter the volume name for OCR: [b] (ocrvol)
Enter the volume size for OCR (in MB): [b] (320)
Enter the volume name for Vote: [b] (votevol)
Enter the volume size for Vote (in MB): [b] (320)

```

**4 Enter the Oracle UNIX user name.**

```

Enter Oracle UNIX user name: [b] oracle

```

**5 Enter the Oracle UNIX group name.**

```

Enter Oracle UNIX group name: [b] (oinstall)

```

**6 Press **Return** to continue.**

**7 Review and confirm the configuration information. The installer creates and starts the volumes on all nodes in the cluster.**



- 8 Enter the CFS mount point for OCR and voting disk information.
- If you have chosen to create a shared file system for OCR and voting disk, enter the following information:

```
Enter the mount point location for CFS
(common for all the nodes) [b] (/ocrvote)
```

- If you have chosen to create separate file systems for OCR and voting disk, enter the following information:

```
Enter the mount point location for OCR storage
(common for all the nodes): [b] (/ocr)
Enter the mount point location for Vote storage
(common for all the nodes): [b] (/vote)
```

The installer creates the CFS mount points and sets the ownership. Press **Return** to continue.

- 9 Verify that the corresponding CVMVoIDg and CFSMount resources are online on all nodes in the cluster:

---

**Note:** It takes a few minutes for the CVMVoIDg resource to come online.

---

```
hares -state ocrvotemnt_resname

hares -state ocrvotevol_resname
```

## Creating storage for OCR and voting disk using the SF Oracle RAC Web-based installer

The SF Oracle RAC installer enables you to create OCR and voting disk storage on CVM raw volumes or on a clustered file system. After creating the storage, the installer adds the storage configuration to VCS for high availability.

If you are creating the OCR and voting disk storage on CVM raw volumes, the installer performs the following tasks:

- Creates CVM volumes for OCR and voting disk (two-way mirrored or unmirrored) and sets the ownership
- Starts the volumes
- Adds the CVMVoIDg resource to the VCS configuration in the cvm group so that the volumes are brought online automatically when the nodes start
- Brings the CVMVoIDg resource online

If you are creating the OCR and voting disk storage on CFS, the installer performs the following tasks:

- Creates CVM volumes for OCR and voting disk (two-way mirrored or unmirrored)
- Starts the volumes
- Creates the mount point and mounts it on all the nodes
- Sets the ownership for the CFS mount point
- Adds the CFSSMount and CVMVolDg resources to the VCS configuration in the cvm group so that the resources are brought online automatically when the node starts
- Brings the CFSSMount and CVMVolDg resources online

**To create storage for OCR and voting disk**

- 1 From the SF Oracle RAC installer menu, select the option **Create Storage for OCR and Voting disk**. Click **Next**.

Confirm that SF Oracle RAC is running.

- 2 Confirm whether you want to create the storage using the installer or manually:

Do you want the installer to assist you in creating disk groups, volumes and file systems for Oracle?

Click **Yes** to create the storage.

If you want to create the storage manually, click **No**. The installer displays instructions for creating the storage manually. Follow the displayed instructions to create the storage.

- 3 Select an appropriate option for the disk group:

- **Create a disk group**
- **Use an existing disk group**

If you want to mirror the CVM volumes, click **Yes** at the following prompt:

Do you want to enable mirroring?

4 Depending on the disk group option selected, do one of the following:

**Create a disk group**

Enter the name of the disk group in the **New Disk Group Name** text box.

Example: **ocrvotedg**.

If you choose to create a disk group, the installer displays the list of existing disks that do not belong to any disk group. Select the disk that you want to use to create the disk group. If you chose to mirror the CVM volumes, select at least two disks.

**Use an existing disk group**

If you choose to use an existing disk group, the installer displays the list of existing disk groups. Select a disk group. If you chose to mirror the CVM volumes, select an existing disk group that contains at least two disks for mirroring. Click **Next**.

5 Click **Yes** to confirm the configuration information displayed:

The installer initializes the disk groups.

6 Choose the type of storage.

- To create the storage on CVM raw volumes:

See [“Creating the OCR and voting disk storage on CVM raw volumes”](#) on page 259.

- To create the storage on CFS:

See [“Creating the OCR and voting disk storage on CFS”](#) on page 261.

**Creating the OCR and voting disk storage on CVM raw volumes**

Perform the steps in the following procedure to create the storage for OCR and voting disk on CVM raw volumes.

---

**Note:** For Oracle RAC 11g Release 2, you may create CVM raw volumes to create ASM disk groups that may be used to store the OCR and voting disk information.

---

**To create the OCR and voting disk storage on CVM raw volumes**

- 1 Select the option **CVM raw volumes**. Click **Next**.
- 2 Provide the following information:

**Enter the volume name for OCR** Enter the name of the volume on which you want to store OCR information.  
Example: **ocrvol**

**Enter the volume name for Vote** Enter the name of the volume on which you want to store voting disk information.  
Example: **votevol**

**Enter the volume size for OCR (in MB)** Enter the size of the volume on which you want to store OCR information. A minimum of 320 MB volume size is required.  
Example: **320**

**Enter the volume size for Vote (in MB)** Enter the size of the volume on which you want to store voting disk information. A minimum of 320 MB volume size is required.  
Example: **320**

Click **Next**.

- 3 Provide the Oracle user information:

**Enter the Oracle UNIX user name** Enter the name of the Oracle user.  
Example:  
For Oracle RAC 10g Release 2: **oracle**  
For Oracle RAC 11g Release 2:  
**grid**

**Enter the Oracle UNIX group name** Enter the name of the Oracle group.  
Example: **oinstall**

Click **Next**.

- 4 Click **Yes** to confirm the configuration information. The installer creates the volumes and brings the corresponding resources online.
- 5 Verify that the resource is online on all nodes in the cluster.

---

**Note:** It takes a few minutes for the CVMVolDg resource to come online.

---

```
hares -state ocrvotevol_resname
```

### Creating the OCR and voting disk storage on CFS

Perform the steps in the following procedure to create the storage for OCR and voting disk on CFS.

#### To create the OCR and voting disk storage on CFS

- 1 Select the option **Clustered File System**. Click **Next**.
- 2 Specify whether you want to create separate file systems for OCR and voting disk:

```
Do you want to create separate filesystems for ocr and vote?
[y,n,q] (y)
```

- 3 Enter the name and size of the volume on which you want to store OCR and voting disk information.
  - If you have chosen to create a shared file system for OCR and voting disk, enter the following information:

**Enter the volume name for OCR and Voting Disk** Enter the name of the volume on which you want to store OCR and voting disk information.

Example: **ocrvotevol**

**Enter the volume size for OCR and Voting disk (in MB)** Enter the size of the volume on which you want to store OCR and voting disk information. A minimum of 640 MB volume size is required.

Example: **640**

- If you have chosen to create separate file systems for OCR and voting disk, enter the following information:

**Enter the volume name for OCR** Enter the name of the volume on which you want to store OCR information.

Example: **ocrvol**

**Enter the volume name for Vote** Enter the name of the volume on which you want to store voting disk information.

Example: **votevol**

**Enter the volume size for OCR and Voting disk (in MB)** Enter the size of the volume on which you want to store OCR information. A minimum of 320 MB volume size is required.

Example: **320**

**Enter the volume size for Vote (in MB)** Enter the size of the volume on which you want to store voting disk information. A minimum of 320 MB volume size is required.

Example: **320**

Click **Next**.

**4** Provide the Oracle user information:

**Enter the Oracle UNIX user name** Enter the name of the Oracle user.

Example:

For Oracle RAC 10g Release 2: **oracle**

For Oracle RAC 11g Release 2:

**grid**

**Enter the Oracle UNIX group name** Enter the name of the Oracle group.

Example: **oinstall**

Click **Next**.

**5** Click **Yes** to confirm the configuration information. The installer creates and starts the volumes on all nodes in the cluster.

**6** Enter the CFS mount point for OCR and voting disk information.

- If you have chosen to create a shared file system for OCR and voting disk, enter the following information:

**Enter the mount point location for CFS (common for all the nodes):** Example: **/ocrvote**

- If you have chosen to create separate file systems for OCR and voting disk, enter the following information:

**Enter the mount point location for OCR** Example: /ocr  
(common for all the nodes):

**Enter the mount point location for Vote** Example: /vote  
(common for all the nodes):

Click **Next**.

The installer creates the CFS mount points and sets the ownership.

- 7 Verify that the corresponding CVMVolDg and CFMount resources are online on all nodes in the cluster:

---

**Note:** It takes a few minutes for the CVMVolDg resource to come online.

---

For example:

```
hares -state ocrvotemnt_resname

hares -state ocrvotevol_resname
```

## Creating storage for OCR and voting disk manually

Use one of the following storage options to create the OCR and voting disk storage:

|                 |                                                                                          |
|-----------------|------------------------------------------------------------------------------------------|
| CVM raw volumes | See <a href="#">“To create OCR and voting disk volumes on raw volumes”</a> on page 263.  |
| CFS             | See <a href="#">“To create the storage for OCR and voting disks on CFS”</a> on page 264. |

---

**Note:** Whether you create volumes or file system directories, you can add them to the VCS configuration to make them highly available.

---

### To create OCR and voting disk volumes on raw volumes

- 1 Log in as the root user.
- 2 Create a shared disk group:

```
vxdbg -s init ocrvote_dgname disk_name2 disk_name3
```

- 3 Set the activation mode for the disk group on all the nodes.

```
vxdbg -g ocrvote_dgname set activation=sw
```

- 4 Create mirrored volumes in the shared group for OCR and voting disk:

```
vxassist -g ocrvote_dgname make ocr_volname 300M nmirrors=2
vxassist -g ocrvote_dgname make vote_volname 300M nmirrors=2
```

- 5 Set the ownership for the volumes:

```
vxedit -g ocrvote_dgname set group=grp_name \
user=user_name mode=660 ocr_volname
vxedit -g ocrvote_dgname set group=grp_name \
user=user_name mode=660 vote_volname
```

- 6 Start the volume:

```
vxvol -g ocrvote_dgname startall
```

- 7 Add the storage resources to the VCS configuration to make them highly available.

See [“Adding the storage resources to the VCS configuration”](#) on page 265.

#### To create the storage for OCR and voting disks on CFS

- 1 Create a shared VxVM disk group:

```
vxdg -s init ocrvote_dgname disk_name2 disk_name3
```

- 2 Set the activation mode for the disk group on all the nodes.

```
vxdg -g ocrvote_dgname set activation=sw
```

- 3 From the CVM master node, start the disk group:

```
vxvol -g ocrvote_dgname startall
```

- 4 From the CVM master, create a mirrored volume (for example `ocrvotevol`) for OCR and voting disk:

```
vxassist -g ocrvote_dgname make ocrvote_volname 640M nmirrors=2
```

- 5 From the CVM master, create a file system with the volume (`ocrvotevol`).

```
mkfs -F vxfs /dev/vx/rdisk/ocrvote_dgname/ocrvote_volname
```



- 6 Start the volume:

```
vxvol -g ocrvote_dgname startall
```

- 7 On each system, create a directory (for example, /ocrvote) on which to mount the file system containing OCR and voting disk.

```
mkdir /ocrvote_mnt
```

- 8 On each system, mount the file system containing OCR and voting disk:

```
mount -F vxfs -o cluster /dev/vx/dsk/ocrvote_dgname/\
ocrvote_volname ocrvote_mnt
```

- 9 From any system, change permissions on the file system containing OCR and voting disk.

For example:

For Oracle RAC 10g Release 2:

```
chown -R oracle:oinstall ocrvote_mnt
```

For Oracle RAC 11g Release 2:

```
chown -R grid:oinstall ocrvote_mnt
```

- 10 Add the storage resources to the VCS configuration to make them highly available.

See [“Adding the storage resources to the VCS configuration”](#) on page 265.

### Adding the storage resources to the VCS configuration

The type of storage resource you add to the VCS configuration depends on whether you chose to create the OCR and voting disk storage on raw volumes or CFS. If you chose to create the storage on raw volumes, you need to add a CVMVolDg resource to the VCS configuration. If you chose to create the storage on CFS, you need to add the CVMVolDg and CFMount resources to the VCS configuration.

Depending on the type of storage, follow the steps in one of the following procedures to add the storage resources to the VCS configuration using the command line interface (CLI):

For storage resources on CFS See [“To add the storage resources created on CFS to the VCS configuration”](#) on page 266.

For storage resources on CVM See ["To add the storage resources created on raw volumes to the VCS configuration"](#) on page 268.

---

**Note:** Set the attribute "Critical" to "0" for all the resources in the cvm service group. This ensures that critical CVM and CFS resources are always online.

---

### To add the storage resources created on CFS to the VCS configuration

- 1 Change the permission on the VCS configuration file to read-write mode:

```
haconf -makerw
```

- 2 Configure the CVM volumes under VCS:

```
hares -add ocrvotevol_resname CVMVolDg cvm_grpname
hares -modify ocrvotevol_resname Critical 0
hares -modify ocrvotevol_resname CVMDiskGroup ocrvote_dgname
hares -modify ocrvotevol_resname CVMVolume -add ocrvote_volname
hares -modify ocrvotevol_resname CVMActivation sw
```

- 3 Set up the file system under VCS:

```
hares -add ocrvotemnt_resname CFSSMount cvm_grpname
hares -modify ocrvotemnt_resname Critical 0
hares -modify ocrvotemnt_resname MountPoint ocrvote_mnt
hares -modify ocrvotemnt_resname BlockDevice \
/dev/vx/dsk/ocrvote_dgname/ocrvote_volname
```

- 4 Link the parent and child resources:

```
hares -link ocrvotevol_resname cvm_clus
hares -link ocrvotemnt_resname ocrvotevol_resname
hares -link ocrvotemnt_resname vxfsckd
```

**5** Enable the resources:

```
hares -modify ocrvotevol_resname Enabled 1

hares -modify ocrvotemnt_resname Enabled 1

haconf -dump -makero
```

**6** Verify the configuration of the CVMVolDg and CFSSMount resources in the main.cf file.

For example:

```
CFSSMount ocrvote_mnt_ocrvotedg (
 Critical = 0
 MountPoint = "/ocrvote"
 BlockDevice = "/dev/vx/dsk/ocrvotedg/ocrvotevol"
)

CVMVolDg ocrvote_voldg_ocrvotedg (
 Critical = 0
 CVMDiskGroup = ocrvotedg
 CVMVolume = { ocrvotevol }
 CVMActivation = sw
)

ocrvote_mnt_ocrvotedg requires ocrvote_voldg_ocrvotedg
ocrvote_mnt_ocrvotedg requires vxfsckd
ocrvote_voldg_ocrvotedg requires cvm_clus
```

**7** Bring the CFSSMount and CVMVolDg resources online on all systems in the cluster:

```
hares -online ocrvotevol_resname -sys node_name

hares -online ocrvotemnt_resname -sys node_name
```

Verify that the resources are online on all systems in the cluster:

```
hares -state ocrvotevol_resname

hares -state ocrvotemnt_resname
```

**To add the storage resources created on raw volumes to the VCS configuration**

- 1 Change the permissions on the VCS configuration file:

```
haconf -makerw
```

- 2 Configure the CVM volumes under VCS:

```
hares -add ocrvotevol_resname CVMVolDg cvm_grpname
hares -modify ocrvotevol_resname Critical 0
hares -modify ocrvotevol_resname CVMDiskGroup ocrvote_dgname
hares -modify ocrvotevol_resname CVMVolume -add ocr_volname
hares -modify ocrvotevol_resname CVMVolume -add vote_volname
hares -modify ocrvotevol_resname CVMActivation sw
```

- 3 Link the parent and child resources:

```
hares -link ocrvotevol_resname cvm_clus
```

- 4 Enable the resources:

```
hares -modify ocrvotevol_resname Enabled 1
haconf -dump -makero
```

- 5 Verify the configuration of the CVMVolDg resource in the main.cf file.

For example:

```
CVMVolDg ocrvote_voldg_ocrvotedg (
 Critical = 0
 CVMDiskGroup = ocrvotedg
 CVMVolume = { ocrvol, votevol }
 CVMActivation = sw
)
ocrvote_voldg_ocrvotedg requires cvm_clus
```

- 6 Bring the ocrvote\_voldg\_ocrvotedg resource online on all systems in the cluster:

```
hares -online ocrvotevol_resname -sys node_name
```

Verify that the resource is online on all systems in the cluster:

```
hares -state ocrvotevol_resname
```

## Configuring private IP addresses for Oracle RAC

Private IP addresses are required by Oracle RAC to provide communication between the cluster nodes. Depending on your private network configuration, you may need one or more IP addresses. You can configure the private IP addresses for high availability using the PrivNIC or MultiPrivNIC agents.

---

**Note:** IPv6 addresses are not supported in this release.

---

[Table 21-1](#) lists the available options for configuring the private network for Oracle RAC. Use one of the following options to configure the private network.

**Table 21-1** Options for configuring the private network for Oracle RAC

| Option                     | Description                                                                                                                                                                                                                                                                                                                                                                                                                                                                                                                                                                                                                                                                                                                     |
|----------------------------|---------------------------------------------------------------------------------------------------------------------------------------------------------------------------------------------------------------------------------------------------------------------------------------------------------------------------------------------------------------------------------------------------------------------------------------------------------------------------------------------------------------------------------------------------------------------------------------------------------------------------------------------------------------------------------------------------------------------------------|
| PrivNIC configuration      | <p>Perform this configuration if you plan to:</p> <ul style="list-style-type: none"> <li>■ Use a common IP address for Oracle Clusterware/Grid Infrastructure heartbeat and Oracle RAC database cache fusion and you plan to configure the IP address for high availability using the PrivNIC agent.</li> <li>■ Or, in the case of Oracle RAC 10g Release 2, use VCSIPC/LMX/LLT for Oracle RAC database cache fusion (you need an IP address only for Oracle Clusterware heartbeat in this scenario) and you plan to configure the IP address for high availability using the PrivNIC agent.</li> </ul> <p>For instructions:<br/>See <a href="#">“Configuring the private IP address and PrivNIC resource”</a> on page 270.</p> |
| MultiPrivNIC configuration | <p>Perform this configuration if you plan to:</p> <ul style="list-style-type: none"> <li>■ Use an IP address on each node for Oracle Clusterware/Grid Infrastructure heartbeat</li> <li>■ And, use one or more IP addresses on each node for Oracle database cache fusion</li> <li>■ And, configure the IP addresses for high availability using the MultiPrivNIC agent</li> </ul> <p>For instructions:<br/>See <a href="#">“Configuring the private IP address information and MultiPrivNIC resource”</a> on page 277.</p>                                                                                                                                                                                                     |

## Configuring the private IP address and PrivNIC resource

You need to configure the following information:

- An IP address on each node  
If you plan to install Oracle RAC 10g Release 2, the IP addresses configured must be added to the `/etc/hosts` file (using the SF Oracle RAC installer or manually) on all the nodes before installing Oracle Clusterware/Grid Infrastructure.
- The PrivNIC agent for failing over IP addresses in the event of link failures. The Oracle Clusterware/Grid Infrastructure interconnects need to be protected against NIC failures and link failures. The installer discovers the existing private NICs on which LLT is configured. For maximum failover options, all available LLT links are used for PrivNIC configuration.

---

**Note:** The PrivNIC agent is not supported with Oracle RAC 11.2.0.2 and later versions. For more information, see <http://www.symantec.com/business/support/index?page=content&id=TECH145261>

---

Use one of the following ways to configure the PrivNIC and private IP address information:

|                                      |                                                                                                                                    |
|--------------------------------------|------------------------------------------------------------------------------------------------------------------------------------|
| SF Oracle RAC script-based installer | See “ <a href="#">Configuring the private IP address and PrivNIC using the SF Oracle RAC script-based installer</a> ” on page 271. |
| SF Oracle RAC Web-based installer    | See “ <a href="#">Configuring the private IP address and PrivNIC using the SF Oracle RAC Web-based installer</a> ” on page 274.    |
| Manual                               | See “ <a href="#">Configuring the private IP address and PrivNIC resource manually</a> ” on page 276.                              |

### **Configuring the private IP address and PrivNIC using the SF Oracle RAC script-based installer**

The SF Oracle RAC installer performs the following tasks:

- Backs up the /etc/hosts file and adds the IP address information to the file (only if you specified that the installer update the file).
- Adds the PrivNIC resource in the CVM group.

Perform the steps in the following procedure to configure the PrivNIC and private IP address using the installer.

**To configure the PrivNIC and private IP address information**

**1 From the SF Oracle RAC menu, enter 3 to select the option Oracle Network Configuration.**

- 1) Create Oracle Users and Groups
  - 2) Create Storage for OCR and Voting disk
  - 3) Oracle Network Configuration
  - 4) Exit SF Oracle RAC Configuration
  - b) Back to previous menu
- Choose option: [1-4,b,q] (1) **3**

**2 Enter 1 to select the option Configure private IP addresses (PrivNIC Configuration).**

- 1) Configure private IP addresses (PrivNIC Configuration)
  - 2) Configure private IP addresses (MultiPrivNIC Configuration)
  - 3) Exit SF Oracle RAC Configuration
  - b) Back to previous menu
- Choose option: [1-3,b,q] (1) **1**

The installer discovers available LLT links and PrivNIC resources.

If PrivNIC resources exist, you can choose to delete and reconfigure the resources using the installer.

---

**Note:** The installer only removes the corresponding PrivNIC resources from the configuration file. You must manually disassociate the IP addresses from the corresponding network interfaces and remove the IP addresses from the /etc/hosts file.

---

**3 Enter the name for the PrivNIC resource.**

Enter the PrivNIC resource name: [b] (ora\_priv)

**4 Enter y to modify the priority of the PrivNIC interfaces.**

---

**Note:** The priority you set determines the interface that the PrivNIC agent chooses during failover.

---

Do you want to update the priority of the PrivNIC interfaces? [y,n,q] (n) **y**



- 5 Set the interface priority in decreasing order. The PrivNIC agent will assign the highest priority to the first interface specified in the list.

Enter the interface name in the decreasing priority order, separated by a space: [b] (lan2 lan3) **lan3 lan2**

- 6
  - Enter **y** to add the IP addresses to the `/etc/hosts` file.
  - Enter **n** if you choose to add the IP addresses to the file manually. Go to step 8.
- 7 Perform this step only if you enabled the installer to add the IP address to the `/etc/hosts` file in the previous step.

Provide the private IP address and the private node name for the IP address that must be added to the file.

---

**Note:** All IP addresses must be in the same subnet, failing which Oracle Clusterware/Grid Infrastructure will not be able to communicate properly across the nodes.

If the private IP address entries are already present in the `/etc/hosts` file on one of nodes in the cluster, the installer does not update the file with the specified IP addresses on any of the nodes in the cluster.

---

```
Enter the private IP for sys1: [b] 192.168.12.1
Enter Hostname alias for the above IP address: [b] sys1-priv
Enter the private IP for sys2: [b] 192.168.12.2
Enter Hostname alias for the above IP address: [b] sys2-priv
```

Go to step 9.

- 8 Perform this step only if you have chosen to add the IP address to the `/etc/hosts` file manually.

Enter the private IP address information.

```
Enter the private IP for sys1: [b] 192.168.12.1
Enter the private IP for sys2: [b] 192.168.12.2
```

- 9 Enter the netmask information for the private network:

```
Enter the Netmask for private network: [b] (255.255.255.0)
```

The SF Oracle RAC installer now displays the configuration information.

- 10 Enter **y** to review and confirm the configuration information. The installer adds the PrivNIC resources to the VCS configuration and updates the `/etc/hosts` file (if you chose an installer-based update).
- 11 If you chose to add the IP address information to the `/etc/hosts` file manually, proceed to update the file as described in the following procedure.  
See [“Adding private IP addresses to the /etc/hosts file manually”](#) on page 286.
- 12 Verify the PrivNIC configuration updates made by the program in the `main.cf` file.  
See [“Verifying the VCS configuration for PrivNIC and MultiPrivNIC”](#) on page 287.

### Configuring the private IP address and PrivNIC using the SF Oracle RAC Web-based installer

The SF Oracle RAC installer performs the following tasks:

- Backs up the `/etc/hosts` file and adds the IP address information to the file (only if you specified that the installer update the file).
- Adds the PrivNIC resource in the CVM group.

Perform the steps in the following procedure to configure the PrivNIC and private IP address using the installer.

#### To configure the PrivNIC and private IP address information

- 1 From the SF Oracle RAC menu, select the option **Oracle Network Configuration**. Click **Next**.
- 2 Select the option **Configure private IP addresses (PrivNIC Configuration)** from the Select a Task drop-down list. Click **Next**.

The installer discovers available LLT links and PrivNIC resources.

If PrivNIC resources exist, you can choose to delete and reconfigure the resources using the installer.

---

**Note:** The installer only removes the corresponding PrivNIC resources from the configuration file. You must manually disassociate the IP addresses from the corresponding network interfaces and remove the IP addresses from the `/etc/hosts` file.

---

- 3 Enter the name for the PrivNIC resource.

Enter the PrivNIC resource name (`ora_priv`):

Click **Next**.

- 4 Click **Yes** in the confirmation dialog box to modify the priority of the PrivNIC interfaces.

---

**Note:** The priority you set determines the interface that the PrivNIC agent chooses during failover.

---

Set the interface priority in decreasing order. The PrivNIC agent will assign the highest priority to the first interface specified in the list.

Enter the interface name in the decreasing priority order, separated by a space (lan2 lan3): **lan3 lan2**

Click **Next**.

- 5
  - Click **Yes** to add the IP addresses to the `/etc/hosts` file.
  - Click **No** if you choose to add the IP addresses to the file manually. Go to step 7.
- 6 Perform this step only if you enabled the installer to add the IP address to the `/etc/hosts` file in the previous step.

Provide the private IP address and the private node name for the IP address that must be added to the file.

---

**Note:** All IP addresses must be in the same subnet, failing which Oracle Clusterware/Grid Infrastructure will not be able to communicate properly across the nodes.

If the private IP address entries are already present in the `/etc/hosts` file on one of nodes in the cluster, the installer does not update the file with the specified IP addresses on any of the nodes in the cluster.

---

Enter the private IP for sys1: **192.168.12.1**  
 Enter Hostname alias for the above IP address: **sys1-priv**  
 Enter the private IP for sys2: **192.168.12.2**  
 Enter Hostname alias for the above IP address: **sys2-priv**

Click **Next**.

Go to step 8.

- 7 Perform this step only if you have chosen to add the IP address to the `/etc/hosts` file manually.

Enter the private IP address information.

```
Enter the private IP for sys1: 192.168.12.1
Enter the private IP for sys2: 192.168.12.2
```

- 8 Enter the netmask information for the private network:

```
Enter the Netmask for private network (255.255.255.0):
```

Click **Next**.

The SF Oracle RAC installer now displays the configuration information.

- 9 Click **Yes** to review and confirm the configuration information. The installer adds the PrivNIC resources to the VCS configuration and updates the `/etc/hosts` file (if you chose an installer-based update).
- 10 If you chose to add the IP address information to the `/etc/hosts` file manually, proceed to update the file as described in the following procedure.  
See [“Adding private IP addresses to the /etc/hosts file manually”](#) on page 286.
- 11 Verify the PrivNIC configuration updates made by the program in the `main.cf` file.  
See [“Verifying the VCS configuration for PrivNIC and MultiPrivNIC”](#) on page 287.

### Configuring the private IP address and PrivNIC resource manually

Perform the steps in the following procedure to configure the private IP address and PrivNIC resource manually. Configure the PrivNIC resource in the VCS group where you have configured the OCR and voting disk resources.

The sample procedure creates the PrivNIC resource in the `cvm` group. The PrivNIC agent plumbs the IP address to the specified network interface.

#### To configure the private IP address and PrivNIC resource manually

- 1 Log in as the root user on one of the nodes in the cluster.
- 2 Change the cluster configuration to read-write mode:

```
haconf -makerw
```

- 3 Create the PrivNIC resource and add the resource to the same group in which you plan to configure the `cssd` resource:

```
hares -add privnic_resname PrivNIC cvm_grpname
```

4 Modify the PrivNIC resource:

```
hares -modify privnic_resname Critical 0
hares -local privnic_resname Device
hares -local privnic_resname Address
hares -modify privnic_resname \
Device -add nic1_node1 0 -sys node_name1
hares -modify privnic_resname \
Device -add nic2_node1 1 -sys node_name1
hares -modify privnic_resname \
Address privnic_ip_node1 -sys node_name1
hares -modify privnic_resname \
Device -add nic1_node2 0 -sys node_name2
hares -modify privnic_resname \
Device -add nic2_node2 1 -sys node_name2
hares -modify privnic_resname \
Address privnic_ip_node2 -sys node_name2
hares -modify privnic_resname \
NetMask netmask_ip
hares -modify privnic_resname Enabled 1
```

5 Change the cluster configuration to read-only mode:

```
haconf -dump -makero
```

## Configuring the private IP address information and MultiPrivNIC resource

You need to configure the following information:

- An IP address on each node for Oracle Clusterware/Grid Infrastructure heartbeats
- One or more IP addresses on each node for the Oracle database
- The MultiPrivNIC agent for failing over IP addresses in the event of link failures. The Oracle Clusterware/Grid Infrastructure interconnects need to be protected against NIC failures and link failures. The MultiPrivNIC agent protects the links against failures, if multiple links are available. The installer discovers the existing private NICs on which LLT is configured. For maximum failover options, all available LLT links are used for MultiPrivNIC configuration.

---

**Note:** The MultiPrivNIC agent is not supported with Oracle RAC 11.2.0.2 and later versions. For more information, see <http://www.symantec.com/business/support/index?page=content&id=TECH145261>

---

If you plan to use Oracle RAC 10g Release 2, the IP addresses configured must be added to the `/etc/hosts` file (using the SF Oracle RAC installer or manually) on all the nodes before installing Oracle Clusterware/Grid Infrastructure.

Use one of the following ways to configure the MultiPrivNIC and private IP address information:

|                                      |                                                                                                                                                   |
|--------------------------------------|---------------------------------------------------------------------------------------------------------------------------------------------------|
| SF Oracle RAC script-based installer | See <a href="#">“Configuring the MultiPrivNIC and private IP address information using the SF Oracle RAC script-based installer”</a> on page 278. |
| SF Oracle RAC Web-based installer    | See <a href="#">“Configuring the MultiPrivNIC and private IP address information using the SF Oracle RAC Web-based installer”</a> on page 281.    |
| Manual                               | See <a href="#">“Configuring MultiPrivNIC and private IP addresses manually ”</a> on page 284.                                                    |

### **Configuring the MultiPrivNIC and private IP address information using the SF Oracle RAC script-based installer**

Perform the steps in the following procedure to configure the MultiPrivNIC and private IP address using the installer.

The installer performs the following tasks:

- Backs up the `/etc/hosts` file and adds the IP address information to the file (only if you specified that the installer update the file).
- Adds the MultiPrivNIC resource in the CVM group.

**To configure the MultiPrivNIC and private IP address information**

**1 From the SF Oracle RAC menu, enter 3 to select the option Oracle Network Configuration.**

- 1) Create Oracle Users and Groups
  - 2) Create Storage for OCR and Voting disk
  - 3) Oracle Network Configuration
  - 4) Exit SF Oracle RAC Configuration
- b) Back to previous menu
- Choose option: [1-4,b,q] (1) **3**

**2 Enter 2 to select the option Configure private IP addresses (MultiPrivNIC Configuration).**

- 1) Configure private IP addresses (PrivNIC Configuration)
  - 2) Configure private IP addresses (MultiPrivNIC Configuration)
  - 3) Exit SF Oracle RAC Configuration
- b) Back to previous menu
- Choose option: [1-3,b,q] (1) **2**

The installer discovers available LLT links and MultiPrivNIC resources. If MultiPrivNIC resources exist, you can choose to delete and reconfigure the resources using the installer.

---

**Note:** The installer only removes the corresponding MultiPrivNIC resources from the configuration file. You must manually disassociate the IP addresses from the corresponding network interfaces and remove the IP addresses from the /etc/hosts file.

---

**3 Enter the name for the MultiPrivNIC resource.**

Enter the MultiPrivNIC resource name: [b] (ora\_mpriv) **multi\_priv**

- 4**
- Enter **y** to add the IP addresses to the /etc/hosts file.
  - Enter **n** if you choose to add the IP addresses to the file manually. Go to step 6.

- 5 Perform this step only if you enabled the installer to add the IP address to the /etc/hosts file in the previous step.

Provide the private IP address and the private node name for the IP addresses that must be added to the file. When you do not want to enter information at the prompts, enter **x**.

---

**Note:** The IP addresses used for a particular NIC on all nodes of a cluster must be in the same subnet. This subnet must be different from the subnets for the IP addresses on other NICs. Otherwise, Oracle Clusterware/Grid Infrastructure and UDP IPC will not be able to communicate properly across the nodes.

If the private IP address entries are already present in the /etc/hosts file on one of the nodes in the cluster, the installer does not update the file with the specified IP addresses on any of the nodes in the cluster.

---

```

Enter IP addresses for sys1 for lan1 separated by space: [b,q,?]
192.168.12.1
Enter Hostname aliases for the above IP addresses
separated by space: [b,q,?] sys1-priv
Enter IP addresses for sys1 for lan2
separated by space: [b,q,?] 192.168.2.1
Enter Hostname aliases for the above IP addresses
separated by space: [b,q,?] sys1-priv1
Enter IP addresses for sys2 for lan1
separated by space: [b,q,?] 192.168.12.2
Enter Hostname aliases for the above IP addresses
separated by space: [b,q,?] sys2-priv
Enter IP addresses for sys2 for lan2
separated by space: [b,q,?] 192.168.2.2
Enter Hostname aliases for the above IP addresses
separated by space: [b,q,?] sys2-priv1

```

Go to step 7.



- 6 Perform this step only if you have chosen to add the IP address to the /etc/hosts file manually.

Enter the private IP address information.

```
Enter IP addresses for sys1 for lan1
separated by space: [b,q,?] 192.168.12.1
Enter IP addresses for sys1 for lan2
separated by space: [b,q,?] 192.168.2.1
Enter IP addresses for sys2 for lan1
separated by space: [b,q,?] 192.168.12.2
Enter IP addresses for sys2 for lan2
separated by space: [b,q,?] 192.168.2.2
```

- 7 Enter the netmask information for the private network:

```
Enter the Netmask for private network: [b] (255.255.255.0)
```

The SF Oracle RAC installer displays the configured parameters.

- 8 Enter **y** to review and confirm the configuration information. The installer adds the MultiPrivNIC resources and updates the /etc/hosts file (if you chose installer-based update).
- 9 If you chose to add the IP address information to the /etc/hosts file manually, proceed to update the file as described in the following procedure.  
See [“Adding private IP addresses to the /etc/hosts file manually”](#) on page 286.
- 10 Verify the MultiPrivNIC configuration updates made by the program in the main.cf file.  
See [“Verifying the VCS configuration for PrivNIC and MultiPrivNIC”](#) on page 287.

### Configuring the MultiPrivNIC and private IP address information using the SF Oracle RAC Web-based installer

Perform the steps in the following procedure to configure the MultiPrivNIC and private IP address using the installer.

The installer performs the following tasks:

- Backs up the /etc/hosts file and adds the IP address information to the file (only if you specified that the installer update the file).
- Adds the MultiPrivNIC resource in the CVM group.

**To configure the MultiPrivNIC and private IP address information**

- 1 From the SF Oracle RAC menu, select the option **Oracle Network Configuration**.
- 2 Select the option **Configure private IP addresses (MultiPrivNIC Configuration)** from the Select a Task drop-down list.

The installer discovers available LLT links and MultiPrivNIC resources. If MultiPrivNIC resources exist, you can choose to delete and reconfigure the resources using the installer.

---

**Note:** The installer only removes the corresponding MultiPrivNIC resources from the configuration file. You must manually disassociate the IP addresses from the corresponding network interfaces and remove the IP addresses from the `/etc/hosts` file.

---

- 3 Enter the name for the MultiPrivNIC resource.

Enter the MultiPrivNIC resource name (multi\_priv): **multi\_priv**

Click **Next**.

- 4
  - Click **Yes** to add the IP addresses to the `/etc/hosts` file.
  - Click **No** if you choose to add the IP addresses to the file manually. Go to step 6.

- 5 Perform this step only if you enabled the installer to add the IP address to the /etc/hosts file in the previous step.

Provide the private IP address and the private node name for the IP addresses that must be added to the file.

---

**Note:** The IP addresses used for a particular NIC on all nodes of a cluster must be in the same subnet. This subnet must be different from the subnets for the IP addresses on other NICs. Otherwise, Oracle Clusterware/Grid Infrastructure and UDP IPC will not be able to communicate properly across the nodes.

If the private IP address entries are already present in the /etc/hosts file on one of the nodes in the cluster, the installer does not update the file with the specified IP addresses on any of the nodes in the cluster.

---

Enter IP addresses for sys1 for lan1 separated by space:

**192.168.12.1**

Enter Hostname aliases for the above IP addresses

separated by space: **sys1-priv**

**Click Next.**

Enter IP addresses for sys1 for lan2

separated by space: **192.168.2.1**

Enter Hostname aliases for the above IP addresses

separated by space: **sys1-priv1**

**Click Next.**

Enter IP addresses for sys2 for lan1

separated by space: **192.168.12.2**

Enter Hostname aliases for the above IP addresses

separated by space: **sys2-priv**

**Click Next.**

Enter IP addresses for sys2 for lan2

separated by space: **192.168.2.2**

Enter Hostname aliases for the above IP addresses

separated by space: **sys2-priv1**

**Go to step 7.**

- 6 Perform this step only if you have chosen to add the IP address to the /etc/hosts file manually.

Enter the private IP address information.

```
Enter IP addresses for sys1 for lan1
separated by space:192.168.12.1
```

Click **Next**.

```
Enter IP addresses for sys1 for lan2
separated by space: 192.168.2.1
```

Click **Next**.

```
Enter IP addresses for sys2 for lan1
separated by space: 192.168.12.2
```

Click **Next**.

```
Enter IP addresses for sys2 for lan2
separated by space: 192.168.2.2
```

Click **Next**.

- 7 Enter the netmask information for the private network:

```
Enter the Netmask for private network (255.255.255.0):
```

The SF Oracle RAC installer displays the configured parameters.

- 8 Click **Yes** to review and confirm the configuration information. The installer adds the MultiPrivNIC resources and updates the /etc/hosts file (if you chose installer-based update).
- 9 If you chose to add the IP address information to the /etc/hosts file manually, proceed to update the file as described in the following procedure.  
See [“Adding private IP addresses to the /etc/hosts file manually”](#) on page 286.
- 10 Verify the MultiPrivNIC configuration updates made by the program in the main.cf file.  
See [“Verifying the VCS configuration for PrivNIC and MultiPrivNIC”](#) on page 287.

### Configuring MultiPrivNIC and private IP addresses manually

Perform the steps in the following procedure to configure MultiPrivNIC and private IP addresses for Oracle Clusterware/Grid Infrastructure and UDP IPC manually. Configure the MultiPrivNIC resource in the VCS group where you have configured the OCR and voting disk resources.

Make sure that the number of links are the same for every node. For example, in the following configuration, if the lan1 and lan2 links fail, the MultiPrivNIC agent fails over the IP addresses to the lan3 link on sys1; On nebula, the absence of a third link results in the agent failing over the link to lan1, which is already down. This results in loss of communication between the nodes and causes Oracle Clusterware/Grid Infrastructure to reboot the cluster.

```
MultiPrivNIC multi_priv (
 Critical = 0
 Device@sys1 = {lan1 = 0, lan2 = 1,
 lan3 = 2}
 Device@sys2 = {lan1 = 0, lan2 = 1}
 Address@sys1 = {"192.168.12.1" = 0,
 "192.168.2.1" = 1}
 Address@sys2 = {"192.168.12.2" = 0,
 "192.168.2.2" = 1}
 NetMask = "255.255.255.0"
)
```

---

**Note:** Avoid configurations where the number of links differ between the nodes.

---

The sample procedure creates the MultiPrivNIC resource in the cvm group. The MultiPrivNIC agent plumbs the IP addresses to the appropriate network interfaces.

### To configure the private IP address and MultiPrivNIC manually

- 1 Log in as the root user on one of the nodes in the cluster.
- 2 Change the cluster configuration to read-write mode:

```
haconf -makerw
```

- 3 Create the MultiPrivNIC resource and add the resource to the same group in which you plan to configure the cssd resource:

```
hares -add multipriv_resname MultiPrivNIC cvm_grpname
```

4 Modify the MultiPrivNIC resource:

```
hares -modify multipriv_resname Critical 0
hares -local multipriv_resname Device
hares -local multipriv_resname Address
hares -modify multipriv_resname \
Device -add nic1_node1 0 -sys node_name1
hares -modify multipriv_resname \
Device -add nic2_node1 1 -sys node_name1
hares -modify multipriv_resname \
Address -add multipriv_ip1_node1 0 -sys node_name1
hares -modify multipriv_resname \
Address -add multipriv_ip2_node1 1 -sys node_name1
hares -modify multipriv_resname \
Device -add nic1_node2 0 -sys node_name2
hares -modify multipriv_resname \
Device -add nic2_node2 1 -sys node_name2
hares -modify multipriv_resname \
Address -add multipriv_ip1_node2 0 -sys node_name2
hares -modify multipriv_resname \
Address -add multipriv_ip2_node2 1 -sys node_name2
hares -modify multipriv_resname \
NetMask netmask_ip
hares -modify multipriv_resname Enabled 1
```

5 Change the cluster configuration to read-only mode:

```
haconf -dump -makero
```

### Adding private IP addresses to the /etc/hosts file manually

Perform the steps in the following procedure only if you plan to install Oracle RAC 10g Release 2 and you chose to add the private IP address information manually to the `/etc/hosts` file at the time of configuring them using the SF Oracle RAC installer.

### To add private IP addresses to the /etc/hosts file manually

- 1 Log in to each system as the root user.
- 2 For a configuration using the PrivNIC agent, add the following entries to the /etc/hosts file.

For example:

```
192.168.12.1 sys1-priv
192.168.12.2 sys2-priv
```

For a configuration using the MultiPrivNIC agent, add the following entries to the /etc/hosts file:

For example:

```
192.168.12.1 sys1-priv
192.168.2.1 sys1-priv1
192.168.12.2 sys2-priv
192.168.2.2 sys2-priv1
```

## Verifying the VCS configuration for PrivNIC and MultiPrivNIC

After you complete the steps for configuring PrivNIC/MultiPrivNIC and the private IP addresses, verify the configuration in the VCS main.cf configuration file.

### To verify the VCS configuration for PrivNIC and MultiPrivNIC

- 1 View the main.cf file located in the directory /etc/VRTSvcs/conf/config:

```
more /etc/VRTSvcs/conf/config/main.cf
```

- 2 For a configuration using the PrivNIC agent:
  - Verify that the PrivNIC resource displays in the file.

For example:

```
PrivNIC ora_priv (
 Critical = 0
 Device @sys1 = {lan1= 0, lan2= 1}
 Device @sys2 = {lan1= 0, lan2= 1}
 Address @sys1 = "192.168.12.1"
 Address @sys2 = "192.168.12.2"
```

```
NetMask = "255.255.255.0"
)
```

- Verify that the PrivNIC resource is online on all nodes in the cluster:

```
hares -state priv_resname
Resource Attribute System Value
ora_priv State sys1 ONLINE
ora_priv State sys2 ONLINE
```

### 3 For a configuration using the MultiPrivNIC agent:

- Verify that the MultiPrivNIC resource displays in the file.  
For example:

```
MultiPrivNIC multi_priv (
 Critical = 0
 Device @sys1 = {lan1= 0, lan2 = 1}
 Device @sys2 = {lan1= 0, lan2 = 1}
 Address @sys1 = {"192.168.12.1" =0, "192.168.2.1" =1}
 Address @sys2 = {"192.168.12.2" =0, "192.168.2.2" =1}
 NetMask = "255.255.255.0"
)
```

- Verify that the MultiPrivNIC resource is online on all systems in the cluster:

```
hares -state multipriv_resname
Resource Attribute System Value
multi_priv State sys1 ONLINE
multi_priv State sys2 ONLINE
```

- 4 Make sure that the specified private IP addresses and devices are displayed when you run the following command:

```
netstat -in
```

- 5 From each system, verify that the private IP addresses are operational using the `ping` command.

## Verifying that multicast is functional on all private network interfaces

Perform this step if you plan to install Oracle RAC 11g Release 2.



Multicast network communication on the private interconnect network must be enabled and functioning on all nodes otherwise the installation or upgrade of Oracle Grid Infrastructure may fail.

For more information, see the Oracle Metalink document: 1212703.1

## Creating Oracle Clusterware/Grid Infrastructure and Oracle database home directories manually

You can create the Oracle Clusterware/Grid Infrastructure and Oracle database home directories on the local file system or on a local Veritas file system, or on a Veritas cluster file system. When the installer prompts for the home directories at the time of installing Oracle Clusterware/Grid Infrastructure and Oracle database, it creates the directories locally on each node, if they do not exist.

---

**Note:** Symantec recommends that Oracle Clusterware and Oracle database binaries be installed local to each node in the cluster. For Oracle Grid Infrastructure binaries, Oracle requires that they be installed only on a local file system. Refer to the Oracle documentation for size requirements.

In the case of Oracle RAC 11g Release 1, only the database is supported. References to Oracle RAC 11g Release 1 in the procedures apply to the Oracle database alone.

---

[Table 21-2](#) lists the Oracle RAC directories you need to create:

**Table 21-2** List of directories

| Directory                                                                          | Description                                                                                                                                                                                                                                                                                                                                                                                                               |
|------------------------------------------------------------------------------------|---------------------------------------------------------------------------------------------------------------------------------------------------------------------------------------------------------------------------------------------------------------------------------------------------------------------------------------------------------------------------------------------------------------------------|
| Oracle Clusterware Home Directory (CRS_HOME)<br><br>(For Oracle RAC 10g Release 2) | The path to the home directory that stores the Oracle Clusterware binaries. The Oracle Universal Installer (OUI) installs Oracle Clusterware into this directory, also referred to as CRS_HOME.<br><br>The directory must be owned by the installation owner of Oracle Clusterware (oracle), with the permission set to 755.<br><br>Follow Oracle Optimal Flexible Architecture (OFA) guidelines while choosing the path. |

**Table 21-2** List of directories (*continued*)

| Directory                                                                                   | Description                                                                                                                                                                                                                                                                                                                                                                                                                                                                                                                                                |
|---------------------------------------------------------------------------------------------|------------------------------------------------------------------------------------------------------------------------------------------------------------------------------------------------------------------------------------------------------------------------------------------------------------------------------------------------------------------------------------------------------------------------------------------------------------------------------------------------------------------------------------------------------------|
| Oracle Grid Infrastructure Home Directory (GRID_HOME)<br><br>(For Oracle RAC 11g Release 2) | <p>The path to the home directory that stores the Oracle Grid Infrastructure binaries. The Oracle Universal Installer (OUI) installs Oracle Grid Infrastructure and Oracle ASM into this directory, also referred to as GRID_HOME.</p> <p>The directory must be owned by the installation owner of Oracle Grid Infrastructure (oracle or grid), with the permission set to 755.</p> <p>The path to the grid home directory must be the same on all nodes.</p> <p>Follow Oracle Optimal Flexible Architecture (OFA) guidelines while choosing the path.</p> |
| Oracle base directory (ORACLE_BASE)                                                         | <p>The base directory that contains all the Oracle installations. For Oracle RAC 11g Release 2, create separate Oracle base directories for the grid user and the Oracle user.</p> <p>It is recommended that installations of multiple databases maintain an Optimal Flexible Architecture (OFA) configuration.</p> <p>The path to the Oracle base directory must be the same on all nodes. The permission on the Oracle base directory must be at least 755.</p>                                                                                          |
| Oracle home directory (ORACLE_HOME)                                                         | <p>The directory in which the Oracle database software is installed. The path to the Oracle home directory must be the same on all nodes. The permission on the Oracle home directory must be at least 755.</p>                                                                                                                                                                                                                                                                                                                                            |

Use one of the following options to create the directories:

- |                     |                                                                                                                                                |
|---------------------|------------------------------------------------------------------------------------------------------------------------------------------------|
| Local file system   | See <a href="#">“To create the directories on the local file system”</a> on page 290.                                                          |
| Cluster File System | See <a href="#">“To create the file system and directories on cluster file system for Oracle Clusterware and Oracle database”</a> on page 293. |

**To create the directories on the local file system**

- 1 Log in as the root user on each node.
- 2 Create a local file system and mount it using one of the following methods:
  - Using native operating system commands  
For instructions, see the operating system documentation.
  - Using Veritas File System (VxFS) commands

As the root user, create a VxVM local diskgroup on each node.

```
vxpdg init vxvm_dg \
dg_name
```

Create separate volumes for Oracle Clusterware/Oracle Grid Infrastructure binaries and Oracle binaries.

```
vxassist -g vxvm_dg make clus_volname size
vxassist -g vxvm_dg make ora_volname size
```

Create the file systems with the volumes.

```
mkfs -F vxfs /dev/vx/rdisk/vxvm_dg/clus_volname
mkfs -F vxfs /dev/vx/rdisk/vxvm_dg/ora_volname
```

Mount the file system.

```
mount -F vxfs /dev/vx/dsk/vxvm_dg/clus_volname \
clus_home
mount -F vxfs /dev/vx/dsk/vxvm_dg/ora_volname \
oracle_home
```

### 3 Create the directories for Oracle RAC.

For Oracle RAC 10g Release 2/Oracle RAC 11g Release 1:

```
mkdir -p oracle_base
mkdir -p clus_home
mkdir -p oracle_home
```

For Oracle RAC 11g Release 2:

```
mkdir -p grid_base
mkdir -p clus_home
mkdir -p oracle_base
mkdir -p oracle_home
```

4 Set appropriate ownership and permissions for the directories.

For Oracle RAC 10g Release 2/Oracle RAC 11g Release 1:

```
chown -R oracle:oinstall clus_home
chmod -R 775 clus_home
```

For Oracle RAC 11g Release 2:

```
chown -R grid:oinstall grid_base
chmod -R 775 grid_base
chown -R grid:oinstall clus_home
chmod -R 775 clus_home
chown -R oracle:oinstall oracle_base
chmod -R 775 oracle_base
chown -R oracle:oinstall oracle_home
chmod -R 775 oracle_home
```

5 Add the resources to the VCS configuration.

See [“To add the storage resources created on VxFS to the VCS configuration”](#) on page 292.

6 Repeat all the steps on each node of the cluster.

**To add the storage resources created on VxFS to the VCS configuration**

1 Change the permissions on the VCS configuration file:

```
haconf -makerw
```

2 Configure the VxVM volumes under VCS:

```
hares -add dg_resname DiskGroup cvm
hares -modify dg_resname DiskGroup vxvm_dg -sys node_name
hares -modify dg_resname Enabled 1
```

3 Set up the file system under VCS:

```
hares -add clusbin_mnt_resname Mount cvm

hares -modify clusbin_mnt_resname MountPoint \
"clus_home"

hares -modify clusbin_mnt_resname BlockDevice \
"/dev/vx/dsk/vxvm_dg/clus_volname" -sys node_name
hares -modify clusbin_mnt_resname FSType vxfs
hares -modify clusbin_mnt_resname FsckOpt "-n"
hares -modify clusbin_mnt_resname Enabled 1
hares -add orabin_mnt_resname Mount cvm

hares -modify orabin_mnt_resname MountPoint \
"oracle_home"

hares -modify orabin_mnt_resname BlockDevice \
"/dev/vx/dsk/vxvm_dg/ora_volname" -sys node_name
hares -modify orabin_mnt_resname FSType vxfs
hares -modify orabin_mnt_resname FsckOpt "-n"
hares -modify orabin_mnt_resname Enabled 1
```

4 Link the parent and child resources:

```
hares -link clusbin_mnt_resname vxvm_dg
hares -link orabin_mnt_resname vxvm_dg
```

5 Repeat all the steps on each node of the cluster.

**To create the file system and directories on cluster file system for Oracle Clusterware and Oracle database**

Perform the following steps on the CVM master node in the cluster.

1 As the root user, create a VxVM shared disk group:

```
vxdg -s init cvm_dg dg_name
```

2 Set the activation mode for the disk group on all the nodes:

```
vxdg -g cvm_dg set activation=sw
```

3 From the CVM master node, start the disk group:

```
vxvol -g cvm_dg startall
```

- 4 Create separate volumes for Oracle Clusterware and Oracle database:

```
vxassist -g cvm_dg make clus_volname size
vxassist -g cvm_dg make ora_volname size
```

- 5 Create the Oracle base directory, clusterware home directory, and the Oracle home directory.

For Oracle RAC 10g Release 2/Oracle RAC 11g Release 1:

```
mkdir -p oracle_base
mkdir -p clus_home
mkdir -p oracle_home
```

For Oracle RAC 11g Release 2:

```
mkdir -p oracle_base
mkdir -p oracle_home
mkdir -p clus_home
mkdir -p grid_base
```

- 6 Create file systems with the volumes:

```
mkfs -F vxfs /dev/vx/rdisk/cvm_dg/clus_volname
mkfs -F vxfs /dev/vx/rdisk/cvm_dg/ora_volname
```

- 7 Mount the file systems. Perform this step on each node.

```
mount -F vxfs -o cluster /dev/vx/dsk/cvm_dg/clus_volname \
clus_home
mount -F vxfs -o cluster /dev/vx/dsk/cvm_dg/ora_volname \
oracle_home
```

**8** Change the ownership and permissions on all nodes of the cluster.

For Oracle RAC 10g Release 2/Oracle RAC 11g Release 1:

```
chown -R oracle:oinstall clus_home
chmod -R 775 clus_home
```

For Oracle RAC 11g Release 2:

```
chown -R grid:oinstall grid_base
chmod -R 775 grid_base
chown -R grid:oinstall clus_home
chmod -R 775 clus_home
chown -R oracle:oinstall oracle_base
chmod -R 775 oracle_base
chown -R oracle:oinstall oracle_home
chmod -R 775 oracle_home
```

**9** Add the CVMVolDg and CFSSMount resources to the VCS configuration.

See [“To add the CFSSMount and CVMVolDg resources to the VCS configuration using CLI”](#) on page 295.

To add the CFSSMount and CVMVolDg resources to the VCS configuration using CLI

**1** Change the permissions on the VCS configuration file:

```
haconf -makerw
```

**2** Configure the CVM volumes under VCS:

```
hares -add dg_resname CVMVolDg cvm
hares -modify dg_resname Critical 0
hares -modify dg_resname CVMDiskGroup cvm_dg
hares -modify dg_resname CVMVolume -add clus_volname
hares -modify dg_resname CVMVolume -add ora_volname
hares -modify dg_resname CVMActivation sw
```

3 Set up the file system under VCS:

```
hares -add clusbin_mnt_resname CFSMount cvm
hares -modify clusbin_mnt_resname Critical 0
hares -modify clusbin_mnt_resname MountPoint \
"clus_home"
hares -modify clusbin_mnt_resname BlockDevice \
"/dev/vx/dsk/cvm_dg/clus_volname"
hares -add orabin_mnt_resname CFSMount cvm
hares -modify orabin_mnt_resname Critical 0
hares -modify orabin_mnt_resname MountPoint \
"oracle_home"
hares -modify orabin_mnt_resname BlockDevice \
"/dev/vx/dsk/cvm_dg/ora_volname"
```

4 Link the parent and child resources:

```
hares -link dg_resname cvm_clus
hares -link clusbin_mnt_resname dg_resname
hares -link clusbin_mnt_resname vxfsckd
hares -link orabin_mnt_resname dg_resname
hares -link orabin_mnt_resname vxfsckd
```

5 Enable the resources:

```
hares -modify dg_resname Enabled 1
hares -modify clusbin_mnt_resname Enabled 1
hares -modify orabin_mnt_resname Enabled 1
haconf -dump -makero
```



**6** Verify the resource configuration in the main.cf file.

The following is a sample resource configuration for Oracle RAC 10g Release 2:

```
CFSMount crsbin_mnt (
 Critical = 0
 MountPoint = "/u01/app/oracle/product/10.2.0/crshome"
 BlockDevice = "/dev/vx/dsk/bindg/crsbinvol"
)

CFSMount orabin_mnt (
 Critical = 0
 MountPoint = "/u01/app/oracle/product/10.2.0/dbhome_1"
 BlockDevice = "/dev/vx/dsk/bindg/orabinvol"
)

CVMVolDg crsorabin_voldg (
 Critical = 0
 CVMDiskGroup = bindg
 CVMVolume = { crsbinvol, orabinvol }
 CVMActivation = sw
)

crsbin_mnt requires crsorabin_voldg
crsbin_mnt requires vxfsckd
orabin_mnt requires crsorabin_voldg
orabin_mnt requires vxfsckd
crsorabin_voldg requires cvm_clus
```

**7** Verify that the resources are online on all systems in the cluster.

```
hares -state dg_resname
hares -state clusbin_mnt_resname
hares -state orabin_mnt_resname
```

---

**Note:** At this point, the crsorabin\_voldg resource is reported offline, and the underlying volumes are online. Therefore, you need to manually bring the resource online on each node.

---

To bring the resource online manually:

```
hares -online dg_resname -sys node_name
```

## Setting up user equivalence

You must establish grid user (Oracle RAC 11g Release 2) and Oracle user equivalence on all nodes to allow the Oracle Universal Installer to securely copy files and run programs on the nodes in the cluster without requiring password prompts.

Set up passwordless SSH communication between the cluster nodes for the Oracle user and the grid user.

For more information, see the Oracle documentation.

## Setting privileges for the DBA group

Set the privileges for the DBA group.

### To set privileges for the DBA user

- 1 Give the MLOCK privilege to the dba group:

```
setprivgrp dba MLOCK
```

For Oracle RAC 11g: In addition to MLOCK, give the RTSCHED and RTPRIO privileges to the dba group:

```
setprivgrp dba RTSCHED
```

```
setprivgrp dba RTPRIO
```

- 2 Create the `/etc/privgroup` file and add the line:

For Oracle RAC 10g:

```
dba MLOCK
```

For Oracle RAC 11g:

```
dba MLOCK RTSCHED RTPRIO
```

- 3 Verify the availability of the privileges for the dba group:

```
/usr/bin/getprivgrp dba
```

# Installing Oracle RAC

This chapter includes the following topics:

- [About installing Oracle RAC](#)
- [Installing the Oracle Clusterware/Grid Infrastructure software](#)
- [Configuring LLT links in the GPnP profile](#)
- [Installing the Oracle RAC database software](#)
- [Verifying the Oracle Clusterware/Grid Infrastructure and database installation](#)

## About installing Oracle RAC

You can install Oracle RAC on shared storage or locally on each node.

---

**Note:** SF Oracle RAC supports the clusterware installation of Oracle versions 10g Release 2 and 11g Release 2. Oracle 11g Release 1 Clusterware is not supported. All database versions starting from Oracle 10g Release 2 and later are supported.

---

Use one of the following ways to install Oracle RAC:

**SF Oracle RAC installer** The SF Oracle RAC installer is available as a script-based or Web-based installer.

The SF Oracle RAC installer starts the installation process and prompts for information that is required by the Oracle Universal Installer. The Oracle Universal Installer launches with these installation values pre-filled and installs Oracle RAC.

You need to invoke the SF Oracle RAC script-based or Web-based installer to start the installation.

|                            |                                                                                                                                                                                                                                                                                                                                                                                                                                                                                                                                                                                                                         |
|----------------------------|-------------------------------------------------------------------------------------------------------------------------------------------------------------------------------------------------------------------------------------------------------------------------------------------------------------------------------------------------------------------------------------------------------------------------------------------------------------------------------------------------------------------------------------------------------------------------------------------------------------------------|
| Oracle Universal Installer | <p>The Oracle Universal Installer installs Oracle RAC. The installation values must be manually entered at the time of installation.</p> <p>You need to invoke the Oracle Universal Installer to install Oracle RAC.</p>                                                                                                                                                                                                                                                                                                                                                                                                |
| Response files             | <p>The SF Oracle RAC script-based installer supports silent installation of Oracle RAC using its own response files. You need to modify the SF Oracle RAC response files to include the path information of the Oracle RAC software binaries and the Oracle RAC response files.</p> <p><b>Note:</b> The SF Oracle RAC Web-based installer does not support silent installation of Oracle RAC.</p> <p>For more information and instructions:</p> <p>See <a href="#">"About response files"</a> on page 353.</p> <p>For instructions, see the chapter "Installing Oracle RAC using a response file" in this document.</p> |

---

**Note:** The instructions in this chapter use variables and sample values wherever required. Replace these variables and sample values with values that conform to your installation requirements.

---

Before you start the installation:

- Keep the Oracle worksheets handy as you perform the installation tasks.  
See ["Required installation information for Oracle Clusterware/Grid Infrastructure"](#) on page 546.  
See ["Required installation information for Oracle database"](#) on page 550.
- Review your Oracle installation manuals and the appropriate Oracle support Web sites for additional information required during the installation.

## Installing the Oracle Clusterware/Grid Infrastructure software

This section provides instructions for installing Oracle Clusterware/Grid Infrastructure using the SF Oracle RAC installer. The SF Oracle RAC installer prompts for information required to invoke the Oracle Universal Installer and launches it. The responses provided to the SF Oracle RAC installer are pre-filled in the Oracle Universal Installer wizard. When you step through the installation, review or change these installation values in the Oracle Universal Installer.

---

**Note:** Before you begin the installation, verify that the nodes in the cluster are connected with network links using similar network devices. For example, if you use lan0 as a public link on one node in the cluster, all other nodes in the cluster must also use lan0 as the public link. Similarly, if you use lan1 as a private link on one node in the cluster, all other nodes in the cluster must also use lan1 as the private link.

---

Oracle Clusterware/Grid Infrastructure software is installed on each node in the CRS\_HOME or GRID\_HOME location, depending on the version of Oracle RAC you install.

---

**Note:** If you want to install Oracle Clusterware/Grid Infrastructure on VxFS or CFS, make sure that you created the appropriate storage before proceeding with the installation.

See [“Creating Oracle Clusterware/Grid Infrastructure and Oracle database home directories manually”](#) on page 289.

---

**Note:** If you want to pass any arguments to the Oracle Universal Installer, then set up the OUI\_ARGS environment variable. You must perform this step before you start the SF Oracle RAC script-based installer.

Refer to the Oracle documentation for details on the arguments that you can pass to the Oracle Universal Installer.

For example: `# export OUI_ARGS=-ignoreSysPrereqs`

---

Install the software using one of the following methods:

|                                      |                                                                                                                                                                                                                                                                                                                          |
|--------------------------------------|--------------------------------------------------------------------------------------------------------------------------------------------------------------------------------------------------------------------------------------------------------------------------------------------------------------------------|
| SF Oracle RAC script-based installer | Using script-based installer:<br><br>See <a href="#">“Installing Oracle Clusterware/Grid Infrastructure using the SF Oracle RAC script-based installer”</a> on page 302.<br><br>Using response files:<br><br>See the chapter <i>Installation of SF Oracle RAC and Oracle RAC using a response file</i> in this document. |
| SF Oracle RAC Web-based installer    | See <a href="#">“Installing Oracle Clusterware/Grid Infrastructure using the SF Oracle RAC web-based installer”</a> on page 305.                                                                                                                                                                                         |
| Oracle Universal Installer           | See <a href="#">“Installing Oracle Clusterware/Grid Infrastructure using the Oracle Universal Installer”</a> on page 308.                                                                                                                                                                                                |

## Installing Oracle Clusterware/Grid Infrastructure using the SF Oracle RAC script-based installer

The SF Oracle RAC installer performs the following tasks:

- Invokes the Oracle Universal Installer to install Oracle Clusterware/Grid Infrastructure
- Verifies the Oracle Clusterware/Grid Infrastructure installation

### To install Oracle Clusterware/Grid Infrastructure using the SF Oracle RAC script-based installer

- 1 Make sure that you completed the required pre-installation steps.
- 2 Return to the following SF Oracle RAC installer menu and select the option **Install Oracle Clusterware/Grid Infrastructure and Database**.  

```
1) Configure SF Oracle RAC sub-components
2) Prepare to Install Oracle
3) Install Oracle Clusterware/Grid Infrastructure and Database
4) Post Oracle Installation Tasks
5) Exit SF Oracle RAC Configuration
Choose option: [1-5,q] (1) 3
```
- 3 Select the option **Install Oracle Clusterware/Grid Infrastructure**.  

```
1) Install Oracle Clusterware/Grid Infrastructure
2) Install Oracle Database
3) Exit SF Oracle RAC Configuration
b) Back to previous menu
Choose option: [1-3,b,q] (1) 1
```
- 4 Verify that the nodes in the cluster are connected with network links using similar network devices. Review the related information on screen and press **Enter** to confirm.  

```
Do you want to continue? [y,n,q] (y)
```
- 5 Set the DISPLAY environment variable that is required for the Oracle Universal Installer:

```
Enter DISPLAY environment variable: [b] 10.20.12.150:0.0
```

where 10.20.12.150 is the IP address of X server where you want to export the display for the installer.

- 6 Enter the Oracle UNIX user name. The Oracle UNIX user name was previously set up during the pre-installation process.

For Oracle RAC 10g Release 2:

```
Enter Oracle UNIX user name: [b] (oracle)
```

For Oracle RAC 11g Release 2:

```
Enter Oracle UNIX user name: [b] (grid)
```

- 7 Enter Oracle UNIX group name. The Oracle UNIX group name was previously set up during the pre-installation process.

```
Enter Oracle UNIX group name: [b] (oinstall)
```

- 8 Enter the full path of the Oracle base directory.

---

**Note:** The ORACLE\_BASE directory must be a local directory.

---

- 9 Enter the full path of the Oracle Clusterware/Grid Infrastructure home directory. If the Oracle Clusterware/Grid Infrastructure home directory you specified does not exist, the installer creates the directory locally on each node and sets appropriate permissions for the Oracle user.

- 10 Enter the full path of the Oracle Clusterware/Grid Infrastructure installation image. Press **Return** to proceed.

The installer detects the version of the Oracle Clusterware/Grid Infrastructure software.

- 11 Enter **y** to continue with the installation.
- 12 Review and confirm the configuration information. The installer invokes the Oracle Universal Installer:
- 13 Enter the required information when prompted by the Oracle Universal Installer. See [“Required installation information for Oracle Clusterware/Grid Infrastructure”](#) on page 546.

- 14 Review the configuration summary presented by the Oracle Universal Installer. The Oracle Universal Installer begins the Oracle Clusterware/Grid Infrastructure installation.

---

**Note:** For Oracle RAC 11g Release 2: If you want to save the Oracle Grid Infrastructure installation configuration into a response file for future installations, click the **Save Response File** option on the Summary page of the Oracle Universal Installer.

---

- 15 For Oracle RAC versions 10.2.0.3 and earlier, patch the `init.cssd` script.
  - Open another window on the system where you are running the installer.
  - Log in as oracle user.
  - Change to the directory where the patch is to be copied:

```
$ cd $CRS_HOME/css/admin
```

```
$ cp /opt/VRTSvcs/rac/patch/init.cssd-10gR2.patch .
```

- As oracle user, run the following command to install the patch:

```
$ /usr/bin/patch < init.cssd-10gR2.patch init.cssd
```

- 16 At the end of the Oracle Clusterware/Grid Infrastructure installation, run the following configuration scripts as the root user from each node of the cluster, in the listed order.
  - `oraInstRoot.sh` (located in the `oraInventory` directory)  
Make sure the script exists on each node before proceeding.
  - `root.sh` (located in the `CRS_HOME` or `GRID_HOME` directory, depending on your Oracle RAC version)

For Oracle RAC 10g Release 2 installations, do not run the scripts simultaneously on the cluster nodes.

---

**Note:** For Oracle RAC 10g Release 2: If `vipca` fails to run silently, run the script manually on one of the nodes as the root user.

```
export DISPLAY=10.20.12.150:0.0
```

```
cd $CRS_HOME/bin
```

```
./vipca
```

---



- 17 Return to the Oracle Universal Installer window and click **OK** to continue.  
 The Oracle Universal Installer informs you that the Oracle Clusterware/Grid Infrastructure installation was successful.
- 18 Return to the SF Oracle RAC installer and press Return to proceed. The installer verifies whether Oracle Clusterware/Grid Infrastructure is installed properly.  
 This completes the Oracle Clusterware/Grid Infrastructure installation.

## Installing Oracle Clusterware/Grid Infrastructure using the SF Oracle RAC web-based installer

The SF Oracle RAC installer performs the following tasks:

- Invokes the Oracle Universal Installer to install Oracle Clusterware/Grid Infrastructure
- Verifies the Oracle Clusterware/Grid Infrastructure installation

### To install Oracle Clusterware/Grid Infrastructure using the SF Oracle RAC web-based installer

- 1 Make sure that you completed the required pre-installation steps.
- 2 Start the Web-based installer.  
 See [“Starting the Veritas Web-based installer”](#) on page 122.
- 3 Select the following menu options from the Select a task and product page:

|                |                                                  |
|----------------|--------------------------------------------------|
| <b>Task</b>    | <b>Configure a Product</b>                       |
| <b>Product</b> | <b>Veritas Storage Foundation for Oracle RAC</b> |

Click **Next**.

- 4 Indicate the systems on which to install the software. Enter one or more system names, separated by spaces. Click **Next**.  
 After the validation completes successfully, click **Next**.
- 5 Select **Install Oracle Clusterware/Grid Infrastructure and Database** from the Select a Task page. Click **Next**.
- 6 Select **Install Oracle Clusterware/Grid Infrastructure** from the Select a Task page. Click **Next**. Review the information on network interfaces and confirm to proceed.

**7** Provide the following information:

- Enter DISPLAY environment variable** Set the DISPLAY environment variable that is required for the Oracle Universal Installer.  
For example, **10.20.12.150:0.0**  
where 10.20.12.150 is the IP address of X server where you want to export the display for the installer.
- Enter Oracle UNIX user name** Oracle RAC 10g Release 2:  
For example, **oracle**  
For Oracle RAC 11g Release 2:  
For example, **grid**
- Enter Oracle UNIX group name** For example, **oinstall**
- Enter absolute path of Oracle Base directory** Enter the full path of the Oracle base directory.  
**Note:** The ORACLE\_BASE directory must be a local directory.
- Enter absolute path of Oracle Clusterware/Grid Infrastructure Home directory** Enter the full path of the Oracle Clusterware/Grid Infrastructure home directory.  
If the Oracle Clusterware/Grid Infrastructure home directory you specified does not exist, the installer creates the specified directory locally on each node and sets appropriate permissions for the Oracle user.
- Enter absolute path of Oracle Clusterware/Grid install image** Enter the full path of the Oracle Clusterware/Grid Infrastructure installation image.  
The installer detects the version of the Oracle Clusterware/Grid Infrastructure software.
- Enter the arguments to be passed to the Oracle installer** Enter one or more of the following arguments (multiple argument values must be separated by a space), if required by Oracle Universal Installer:  
  
`-ignorePrereq`  
`-ignoreSysPrereqs`  
`-ignoreInternalDriverError`  
  
**Note:** Failure to pass one or more of the arguments during Oracle RAC 10g Release 2 installation causes issues with the installation.

Confirm the detected Oracle version to proceed.

- 8 Review and confirm the configuration information. The installer invokes the Oracle Universal Installer.
- 9 Enter the required information when prompted by the Oracle Universal Installer. See [“Required installation information for Oracle Clusterware/Grid Infrastructure”](#) on page 546.
- 10 Review the configuration summary presented by the Oracle Universal Installer. The Oracle Universal Installer begins the Oracle Clusterware/Grid Infrastructure installation.
- 11 For Oracle RAC versions 10.2.0.3 and earlier, patch the `init.cssd` script.
  - Open another window on the system where you are running the installer.
  - Log in as oracle user.
  - Change to the directory where the patch is to be copied:

```
$ cd $CRS_HOME/css/admin
```

```
$ cp /opt/VRTSvcs/rac/patch/init.cssd-10gR2.patch .
```
  - As oracle user, run the following command to install the patch:

```
$ /usr/bin/patch < init.cssd-10gR2.patch init.cssd
```
- 12 At the end of the Oracle Clusterware/Grid Infrastructure installation, run the following configuration scripts as the root user from each node of the cluster, in the listed order.
  - `oraInstRoot.sh` (located in the `oraInventory` directory)  
Make sure the script exists on each node before proceeding.
  - `root.sh` (located in the `CRS_HOME` or `GRID_HOME` directory, depending on your Oracle RAC version)

For Oracle RAC 10g Release 2 installations, do not run the scripts simultaneously on the cluster nodes.

---

**Note:** For Oracle RAC 10g Release 2: If `vipca` fails to run silently, run the script manually on one of the nodes as the root user.

```
export DISPLAY=10.20.12.150:0.0
```

```
cd $CRS_HOME/bin
```

```
./vipca
```

---

- 13 Return to the Oracle Universal Installer window and click **OK** to continue.  
The Oracle Universal Installer informs you that the Oracle Clusterware/Grid Infrastructure installation was successful.
- 14 Return to the SF Oracle RAC installer and click **OK** to proceed. The installer verifies whether Oracle Clusterware/Grid Infrastructure is installed properly.  
This completes the Oracle Clusterware/Grid Infrastructure installation.

## Installing Oracle Clusterware/Grid Infrastructure using the Oracle Universal Installer

This section provides instructions for installing the Oracle Clusterware/Grid Infrastructure software using the Oracle Universal Installer. The software is installed on each node in the Oracle Clusterware/Grid Infrastructure home directory.

### To install Oracle Clusterware/Grid Infrastructure using the Oracle Universal Installer

- 1 Log in as the Oracle grid user (Oracle RAC 11g Release 2) or as the Oracle user (Oracle RAC 10g Release 2). On the first node, set the DISPLAY variable.
  - For Bourne Shell (bash), type:  

```
$ DISPLAY=10.20.12.150:0.0;export DISPLAY
```

where 10.20.12.150 is the IP address of X server where you want to export the display for the installer.
  - For C Shell (csh or tcsh), type:  

```
$ setenv DISPLAY 10.20.12.150:0.0
```

where 10.20.12.150 is the IP address of X server where you want to export the display for the installer.
- 2 Start the Oracle Universal Installer on the first node.

Enter one or more of the following arguments, if required by the Oracle Universal Installer: `-ignorePrereq -ignoreSysPrereqs -ignoreInternalDriverError`

---

**Note:** Failure to pass one or more of the arguments during Oracle RAC 10g Release 2 installation causes issues with the installation.

---

```
$./runInstaller
```

- 3 Enter the required information when prompted by the Oracle Universal Installer. See [“Required installation information for Oracle Clusterware/Grid Infrastructure”](#) on page 546.
- 4 Review the configuration summary presented by the Oracle Universal Installer. The Oracle Universal Installer begins the Oracle Clusterware/Grid Infrastructure installation.

---

**Note:** For Oracle RAC 11g Release 2: If you want to save the Oracle Grid Infrastructure installation configuration into a response file for future installations, click the **Save Response File** option on the Summary page of the Oracle Universal Installer.

---

- 5 For Oracle RAC versions 10.2.0.3 and earlier, patch the `init.cssd` script.
  - Open another window on the system where you are running the installer.
  - Log in as oracle user.
  - Change to the directory where the patch is to be copied:

```
$ cd $CRS_HOME/css/admin
```

```
$ cp /opt/VRTSvcs/rac/patch/init.cssd-10gR2.patch .
```
  - As oracle user, run the following command to install the patch:

```
$ /usr/bin/patch < init.cssd-10gR2.patch init.cssd
```
- 6 At the end of the Oracle Clusterware/Grid Infrastructure installation, run the following configuration scripts as the root user from each node in the cluster, in the listed order:
  - `oraInstRoot.sh` (located in the `oraInventory` directory)  
Ensure that the script exists on each node before proceeding.
  - `root.sh` (located in the `CRS_HOME` or `GRID_HOME` directory, depending on your Oracle RAC version)
- 7 Return to the Oracle Universal Installer window and click **OK** to continue. The Oracle Universal Installer informs you that the Oracle Clusterware/Grid Infrastructure installation was successful. The Oracle Clusterware/Grid Infrastructure daemons are started on the node.

## Configuring LLT links in the GPnP profile

Perform this step only for Oracle RAC 11g Release 2 installations.

Update the GPnP profile to include the remaining LLT links that were not added to the profile during the Oracle Grid Infrastructure installation.

### To configure the LLT links in the GPnP profile

- 1 View the currently configured interfaces:

```
$GRID_HOME/bin/oifcfg getif
lan0 10.2.156.0 global public
lan1 192.168.12.0 global cluster_interconnect
```

The interfaces that are currently stored in the GPnP profile, their subnets, and their role (public or cluster\_interconnect) are displayed.

- 2 Add the remaining LLT links to the GPnP profile:

```
$GRID_HOME/bin/oifcfg setif -global \
lan2/192.168.12.0:cluster_interconnect
```

If you are using multiple IP addresses on different subnet for cluster interconnect (for load balancing), add the remaining interface subnets to the GPnP profile.

```
$GRID_HOME/bin/oifcfg setif -global \
lan2/192.168.2.0:cluster_interconnect
$GRID_HOME/bin/oifcfg setif -global \
lan1/192.168.2.0:cluster_interconnect
```

- 3 Verify that the correct interface subnet is in use:

```
$GRID_HOME/bin/oifcfg getif
lan0 10.2.156.0 global public
lan1 192.168.12.0 global cluster_interconnect
lan2 192.168.12.0 global cluster_interconnect
lan1 192.168.2.0 global cluster_interconnect
lan2 192.168.2.0 global cluster_interconnect
```

Make sure all the LLT links are configured and listed in the GPnP profile.

## Installing the Oracle RAC database software

Before you start the installation of Oracle database, make sure that Oracle Clusterware/Grid Infrastructure is up and running. Symantec recommends you to install the Oracle database locally on each node.

---

**Note:** Make sure any required HP-UX patches listed in the Oracle documentation are installed before you install the Oracle software.

---

**Note:** If you want to install Oracle database on VxFS or CFS, make sure that you created the appropriate storage before proceeding with the installation.

See [“Creating Oracle Clusterware/Grid Infrastructure and Oracle database home directories manually”](#) on page 289.

---

Install the software using one of the following methods:

SF Oracle RAC script-based installer

Using script-based installer:

See [“Installing the Oracle RAC database using the SF Oracle RAC script-based installer”](#) on page 311.

Using response files:

See the chapter *Installation of SF Oracle RAC and Oracle RAC using a response file* in this document.

SF Oracle RAC Web-based installer

See [“Installing the Oracle RAC database using the SF Oracle RAC Web-based installer”](#) on page 313.

Oracle Universal Installer

See [“Installing the Oracle RAC database using the Oracle Universal Installer”](#) on page 316.

## Installing the Oracle RAC database using the SF Oracle RAC script-based installer

The SF Oracle RAC installer performs the following tasks:

- Verifies the status of Oracle Clusterware/Grid Infrastructure on all nodes
- Invokes the Oracle Universal Installer to install the Oracle database
- Verifies the Oracle RAC database installation

**To install the Oracle RAC database using the SF Oracle RAC script-based installer****1 Return to the SF Oracle RAC installer and type 4 to select the option Install Oracle Clusterware/Grid Infrastructure and Database.**

```
1) Configure SF Oracle RAC sub-components
2) Prepare to Install Oracle
3) Install Oracle Clusterware/Grid Infrastructure and Database
4) Post Oracle Installation Tasks
5) Exit SF Oracle RAC Configuration
Choose option: [1-5,q] (1) 3
```

**2 Select the option Install Oracle Database.**

```
1) Install Oracle Clusterware/Grid Infrastructure
2) Install Oracle Database
3) Exit SF Oracle RAC Configuration
b) Back to previous menu
Choose option: [1-3,b,q] (1) 2
```

**3 Set the DISPLAY environment variable that is required for the Oracle Universal Installer.**

```
Enter the DISPLAY environment variable: [b] 10.20.12.150:0.0
```

where **10.20.12.150** is the IP address of X server where you want to export the display for the installer.

**4 Enter Oracle UNIX user name. The Oracle UNIX user name was previously set up during the pre-installation process.**

```
Enter Oracle UNIX user name: [b] (oracle)
```

**5 Enter Oracle UNIX group name. The Oracle UNIX group name was previously set up during the pre-installation process.**

```
Enter Oracle UNIX group name: [b] (oinstall)
```

**6 Enter the full path of the Oracle base directory.**

```
Enter absolute path of Oracle Base directory: [b]
```

**7 Enter the full path of the Oracle Clusterware/Grid Infrastructure home directory.**

```
Enter absolute path of Oracle Clusterware/Grid Infrastructure
Home directory: [b]
```



- 8 Enter the full path of the Oracle database home directory.

Enter absolute path of Oracle Database Home directory: [b]

If the Oracle RAC database home directory you specified does not exist, the installer creates the directory locally on each node and sets appropriate permissions for the Oracle user.

- 9 Enter the full path of the database installation image.

Enter absolute path of Oracle Database install image: [b]

The installer determines the version of the Oracle software from the binaries.

- 10 Enter **y** to proceed with the installation.

- 11 Review and confirm the configuration information.

The installer verifies that Oracle Clusterware/Grid Infrastructure is running and invokes the Oracle Universal Installer:

- 12 Enter the required information when prompted by the Oracle Universal Installer.

See [“Required installation information for Oracle database”](#) on page 550.

- 13 Review the configuration summary presented by the Oracle Universal Installer. The Oracle Universal Installer begins the Oracle database installation.

- 14 Run the root.sh script as the root user on the cluster nodes:

Return to the Oracle Universal Installer window and click **OK** to continue.

- 15 Return to the SF Oracle RAC installer and press **Return** to continue. The installer verifies the Oracle database installation.

---

**Note:** After the installation completes successfully, the installer prompts you to relink the database binaries. Symantec recommends you to relink the SF Oracle RAC libraries only after completing all the required patch additions, if any. See the Oracle documentation for patch updates that may be required.

---

## Installing the Oracle RAC database using the SF Oracle RAC Web-based installer

The SF Oracle RAC installer performs the following tasks:

- Verifies the status of Oracle Clusterware/Grid Infrastructure on all nodes
- Invokes the Oracle Universal Installer to install the Oracle database
- Verifies the Oracle RAC database installation

**To install the Oracle RAC database using the SF Oracle RAC Web-based installer**

- 1 Start the Web-based installer.  
See [“Starting the Veritas Web-based installer”](#) on page 122.
- 2 Select the following menu options from the Select a task and product page:

|                |                                                  |
|----------------|--------------------------------------------------|
| <b>Task</b>    | <b>Configure a Product</b>                       |
| <b>Product</b> | <b>Veritas Storage Foundation for Oracle RAC</b> |

Click **Next**.

- 3 Indicate the systems on which to install. Enter one or more system names, separated by spaces. Click **Next**.  
After the validation completes successfully, click **Next**.
- 4 Select **Install Oracle Clusterware/Grid Infrastructure and Database** from the Select a Task page. Click **Next**.
- 5 Select **Install Oracle Database** from the Select a Task page. Click **Next**.  
Confirm to proceed.

## 6 Provide the following information:

**Enter DISPLAY environment variable** Set the DISPLAY environment variable that is required for the Oracle Universal Installer.

For example, **10.20.12.150:0.0**

where 10.20.12.150 is the IP address of X server where you want to export the display for the installer.

**Enter Oracle UNIX user name** For example, **oracle**

**Enter Oracle UNIX group name** For example, **oinstall**

**Enter absolute path of Oracle Base directory** Enter the full path of the Oracle base directory.  
**Note:** The ORACLE\_BASE directory must be a local directory.

**Enter absolute path of Oracle Clusterware/Grid Infrastructure Home directory** Enter the full path of the Oracle Clusterware/Grid Infrastructure home directory.

**Enter absolute path of Oracle Database Home directory** Enter the full path of the Oracle database home directory.  
If the Oracle RAC database home directory you specified does not exist, the installer creates the directory locally on each node and sets appropriate permissions for the Oracle user.

**Enter absolute path of Oracle Database install image** Enter the full path of the database installation image.  
The installer determines the version of the Oracle software from the binaries.

Confirm the detected Oracle version to proceed.

## 7 Review and confirm the configuration information.

The installer verifies that Oracle Clusterware/Grid Infrastructure is running and invokes the Oracle Universal Installer:

## 8 Enter the required information when prompted by the Oracle Universal Installer.

See [“Required installation information for Oracle database”](#) on page 550.

## 9 Review the configuration summary presented by the Oracle Universal Installer.

The Oracle Universal Installer begins the Oracle database installation.

- 10 Run the `root.sh` script as the root user on the cluster nodes:  
Return to the Oracle Universal Installer window and click **OK** to continue.
- 11 Return to the SF Oracle RAC installer and click **OK** to continue. The installer verifies the Oracle database installation.

---

**Note:** After the installation completes successfully, the installer prompts you to relink the database binaries. Symantec recommends you to relink the SF Oracle RAC libraries only after completing all the required patch additions, if any. See the Oracle documentation for patch updates that may be required.

---

## Installing the Oracle RAC database using the Oracle Universal Installer

The following procedure describes how to install the Oracle RAC database using the Oracle Universal Installer. Symantec recommends that you install the Oracle RAC database locally on each node.

### To install Oracle RAC database using the Oracle Universal Installer

- 1 Log in as the Oracle user. On the first node, set the `DISPLAY` variable.

- For Bourne Shell (`bash`), type:

```
$ DISPLAY=10.20.12.150:0.0;export DISPLAY
```

- For C Shell (`csh` or `tcsh`), type:

```
$ setenv DISPLAY 10.20.12.150:0.0
```

where **10.20.12.150** is the IP address of X server where you want to export the display for the installer.

- 2 Start the Oracle Universal Installer.

```
$./runInstaller -ignoreSysPrereqs
```

- 3 Enter the required information when prompted by the Oracle Universal Installer.  
See [“Required installation information for Oracle database”](#) on page 550.

- 4 Review the configuration summary presented by the Oracle Universal Installer.

---

**Note:** For Oracle RAC 11g Release 2: If you want to save the Oracle RAC database installation configuration into a response file for future installations, click the **Save Response File** option on the Summary page of the Oracle Universal Installer.

---

The Oracle Universal Installer begins the Oracle database installation.

- 5 Run the root.sh script as prompted by the Oracle Universal Installer.

```
cd $ORACLE_HOME
./root.sh
```

## Verifying the Oracle Clusterware/Grid Infrastructure and database installation

- The following procedure verifies the Oracle Clusterware/Grid Infrastructure and Oracle RAC database installation by verifying that the Oracle processes are running on all nodes.

To verify the installation, run the following command from any node in the cluster. Verify in the command output that the Oracle Clusterware/Grid Infrastructure processes are online on the nodes.

For Oracle RAC 10g Release 2:

```
$CRS_HOME/bin/crs_stat -t
```

| Name         | Type        | Target | State  | Host |
|--------------|-------------|--------|--------|------|
| ora.sys1.vip | application | ONLINE | ONLINE | sys1 |
| ora.sys1.gsd | application | ONLINE | ONLINE | sys1 |
| ora.sys1.ons | application | ONLINE | ONLINE | sys1 |
| ora.sys2.vip | application | ONLINE | ONLINE | sys2 |
| ora.sys2.gsd | application | ONLINE | ONLINE | sys2 |
| ora.sys2.ons | application | ONLINE | ONLINE | sys2 |

For Oracle RAC 11g Release 2:

```
$GRID_HOME/bin/crsctl stat res -t
```

---

| NAME | TARGET | STATE | SERVER | STATE_DETAILS |
|------|--------|-------|--------|---------------|
|------|--------|-------|--------|---------------|

```

Local Resources

ora.LISTENER.lsnr
 ONLINE ONLINE sys1
 ONLINE ONLINE sys2
ora.asm
 OFFLINE OFFLINE sys1
 OFFLINE OFFLINE sys2
.
.
.

Cluster Resources

ora.LISTENER_SCAN1.lsnr
 1 ONLINE ONLINE sys2
ora.LISTENER_SCAN2.lsnr
 1 ONLINE ONLINE sys1
ora.LISTENER_SCAN3.lsnr
 1 ONLINE ONLINE sys1
.
.
.

```

- To verify the Oracle RAC database installation, check the oraInventory logs.

## Node numbering discrepancies in Oracle RAC 11g Release 2

For Oracle RAC 11g Release 2, you will observe that the output of the `lsnodes` command (used to obtain membership information from SF Oracle RAC) and the `olsnodes` command (used to obtain membership information from Oracle Grid Infrastructure) differ. Oracle RAC starts the count at 1 while SF Oracle RAC starts the count at 0.

For example, in a two-node cluster:

The `lsnodes` command produces the following output:

```

lsnodes -n
Node1 0
Node2 1

```

The `olsnodes` command produces the following output:

```
olsnodes -n
Node1 1
Node2 2
```

In previous Oracle RAC releases, the commands produced the same output unless there were configuration issues in the cluster. Whenever node numbering discrepancies were observed, further issues were seen in the cluster.

However, the discrepancy in node numbering in Oracle RAC 11g Release 2 is conformant with the design change in Oracle Grid Infrastructure. It does not indicate any configuration issues in the cluster.

# Performing Oracle RAC post-installation tasks

This chapter includes the following topics:

- [Adding Oracle RAC patches or patchsets](#)
- [Configuring the CSSD resource](#)
- [Preventing automatic startup of Oracle Clusterware/Grid Infrastructure](#)
- [Relinking the SF Oracle RAC libraries with Oracle RAC](#)
- [Creating the Oracle RAC database](#)
- [Adding Oracle UDP IPC private IP addresses to the Oracle initialization parameter file](#)
- [Configuring VCS service groups for Oracle RAC](#)
- [Preventing automatic database startup](#)
- [Removing permissions for communication](#)
- [Configuring the Storage Foundation for Databases repository database after installation](#)

## Adding Oracle RAC patches or patchsets

To install the required patches or patchsets, review the notes that accompany the patch or patchset.

Before installing any Oracle RAC patch or patchset software:

- Review the latest information on supported Oracle RAC patches and patchsets:



<http://www.symantec.com/docs/DOC5081>

- You must have installed the base version of the Oracle RAC software.

## Configuring the CSSD resource

You must configure the CSSD resource to ensure that the CSSD dependencies on the resources that manage OCR and voting disk and the private IP address are satisfied before Oracle Clusterware/Grid Infrastructure starts.

---

**Note:** It is mandatory to use CSSD agent in SF Oracle RAC installations. Using the CSSD agent ensures adequate handling of inter-dependencies, thus preventing the premature startup of Oracle Clusterware/Grid Infrastructure, which causes cluster failures.

---

Before you configure the CSSD resource, make sure that the following requirements are satisfied:

1. Oracle Clusterware/Grid Infrastructure is up and running.
2. OCR and voting disk is configured on CVM raw volumes or CFS and managed by VCS.
3. The private IP address for Oracle Clusterware/Grid Infrastructure is configured under the PrivNIC or MultiPrivNIC resource in the same VCS group as that of OCR and voting disk.

---

**Note:** The SF Oracle RAC installer configures the OCR, voting disk, and PrivNIC/MultiPrivNIC resources in the cvm group. If you configured one of these resources manually, make sure that these resources are placed in the cvm group. If the resources are not in the same group, configure the CSSD resource manually.

See [“Configuring the CSSD resource manually”](#) on page 325.

---

**Figure 23-1** illustrates the configuration performed by the SF Oracle RAC installer. In the figure, the CSSD resource is configured under the CVM group.

**Figure 23-1** CSSD configuration by SF Oracle RAC installer

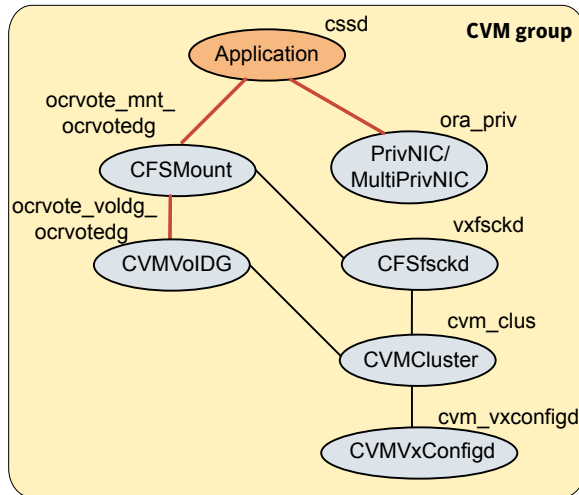

Use one of the following ways to configure the CSSD resource:

- |                                      |                                                                                                                 |
|--------------------------------------|-----------------------------------------------------------------------------------------------------------------|
| SF Oracle RAC script-based installer | See <a href="#">“Configuring the CSSD resource using the SF Oracle RAC script-based installer”</a> on page 322. |
| SF Oracle RAC Web-based installer    | See <a href="#">“Configuring the CSSD resource using the SF Oracle RAC Web-based installer”</a> on page 324.    |
| Manual                               | See <a href="#">“Configuring the CSSD resource manually”</a> on page 325.                                       |

## Configuring the CSSD resource using the SF Oracle RAC script-based installer

Configure the CSSD resource using the SF Oracle RAC installer if the OCR and voting disk storage is configured on CVM raw volumes or CFS.

---

**Note:** If the OCR and voting disk storage is configured on ASM disk groups, configure the CSSD resource manually.

---

The installer performs the following configuration tasks:

- Adds the CSSD resource to the VCS configuration in the cvm group.

---

**Note:** If the CSSD resource already exists, the installer enables reconfiguration of the resource by deleting the existing resource.

---

- Sets the dependency of the CSSD resource on the PrivNIC or MultiPrivNIC resource that manages the private IP address for Oracle Clusterware/Grid Infrastructure.
- Sets the dependency of the CSSD resource on the CFSSMount or CVMVolDg resources that manage OCR and voting disk.
- Enables the CSSD resource and saves the new configuration.

#### To configure the CSSD resource using the SF Oracle RAC script-based installer

- 1 Start the SF Oracle RAC installer, if it is not already running. Select the option **Post Oracle Installation Tasks**.

```
1) Configure SF Oracle RAC sub-components
2) Prepare to Install Oracle
3) Install Oracle Clusterware/Grid Infrastructure and Database
4) Post Oracle Installation Tasks
5) Exit SF Oracle RAC Configuration
Choose option: [1-5,q] (1) 4
```

- 2 Select the option **Configure CSSD agent**.

The installer verifies that Oracle Clusterware/Grid Infrastructure is running on all the nodes.

- 3 Press **Return** to continue with the configuration. The installer reads the resource and group mappings for the CSSD agent from the VCS configuration file and displays the information.
- 4 Enter **y** to continue with the configuration. Review the messages as the installer configures the CSSD agent and sets the appropriate dependencies.
- 5 Press **Return** to return to the installer menu.
- 6 If the Oracle Clusterware/Grid Infrastructure and the Oracle database binaries are on CFS, set the dependencies between the cssd resource and the CFSSMount resources for the binaries manually:

```
hares -link cssd crsbin_mnt
hares -link cssd orabin_mnt
```

## Configuring the CSSD resource using the SF Oracle RAC Web-based installer

Configure the CSSD resource using the SF Oracle RAC installer if the OCR and voting disk storage is configured on CVM raw volumes or CFS.

---

**Note:** If the OCR and voting disk storage is configured on ASM disk groups, configure the CSSD resource manually.

---

The installer performs the following configuration tasks:

- Adds the CSSD resource to the VCS configuration in the cvm group.

---

**Note:** If the CSSD resource already exists, the installer enables reconfiguration of the resource by deleting the existing resource.

---

- Sets the dependency of the CSSD resource on the PrivNIC or MultiPrivNIC resource that manages the private IP address for Oracle Clusterware/Grid Infrastructure.
- Sets the dependency of the CSSD resource on the CFMount or CVMVolDg resources that manage OCR and voting disk.
- Enables the CSSD resource and saves the new configuration.

### To configure the CSSD resource using the SF Oracle RAC Web-based installer

- 1 Start the Web-based installer.  
See [“Starting the Veritas Web-based installer”](#) on page 122.
- 2 Select the following menu options from the Select a task and product page:

|                |                                                  |
|----------------|--------------------------------------------------|
| <b>Task</b>    | <b>Configure a Product</b>                       |
| <b>Product</b> | <b>Veritas Storage Foundation for Oracle RAC</b> |

Click **Next**.

- 3 Indicate the systems on which to install. Enter one or more system names, separated by spaces. Click **Next**.
- 4 After the validation completes successfully, click **Next**.
- 5 Select **Post Oracle Installation Tasks** from the Select a Task page. Click **Next**.
- 6 Select **Configure CSSD agent** from the Select a Task page. Click **Next**.

- 7 Enter the full path of the Oracle Clusterware/Grid Infrastructure home directory. Click **Next**.  
  
The installer verifies that Oracle Clusterware/Grid Infrastructure is running on all the nodes.
- 8 Review and confirm the configuration information. The installer reads the resource and group mappings for the CSSD agent from the VCS configuration file and displays the information.
- 9 Click **Yes** to continue with the configuration.
- 10 If the Oracle Clusterware/Grid Infrastructure and the Oracle database binaries are on CFS, set the dependencies between the cssd resource and the CFSMount resources for the binaries manually:

```
hares -link cssd crsbin_mnt
hares -link cssd orabin_mnt
```

## Configuring the CSSD resource manually

Add the `cssd` resource to the VCS configuration and set CSSD dependencies on the resources that manage OCR and voting disk and the private IP addresses for Oracle Clusterware/Grid Infrastructure.

---

**Note:** It is recommended that the OCR, voting disk, and PrivNIC/MultiPrivNIC resources be configured in the same VCS group as that of the `cssd` resource. If the resources are not in the same group, set the appropriate dependencies between the service groups.

---

### To configure the CSSD resource

- 1 Change the permission on the VCS configuration file to read-write mode:

```
haconf -makerw
```

- 2 Add the CSSD resource to the `cvm` group:

```
hares -add cssd_resname Application cvm_grpname
```

### 3 Modify the CSSD resource attributes:

```
hares -modify cssd_resname StartProgram \
/opt/VRTSvcs/rac/bin/cssd-online
hares -modify cssd_resname StopProgram \
/opt/VRTSvcs/rac/bin/cssd-offline
hares -modify cssd_resname MonitorProgram \
/opt/VRTSvcs/rac/bin/cssd-monitor
hares -modify cssd_resname CleanProgram \
/opt/VRTSvcs/rac/bin/cssd-clean
hares -modify cssd_resname Critical 0
hares -override cssd_resname OnlineWaitLimit
hares -modify cssd_resname OnlineWaitLimit 5
hares -override cssd_resname OfflineWaitLimit
hares -modify cssd_resname OfflineWaitLimit 3
```

### 4 Enable the CSSD resource:

```
hares -modify cssd_resname Enabled 1
```

### 5 Set the dependency of the CSSD resource on the CFSSMount or CVMVoIDg resources that manage OCR and voting disk.

If you configured OCR and voting disk on CVM raw volumes:

```
hares -link cssd ocrvotevol_resname
```

If you configured OCR and voting disk on CFS:

```
hares -link cssd ocrvotemnt_resname
```

### 6 Set the dependency of the CSSD resource on the PrivNIC or MultiPrivNIC resources that manage the private IP address for Oracle Clusterware/Grid Infrastructure.

If you configured the PrivNIC resource:

```
hares -link cssd priv_resname
```

If you configured the MultiPrivNIC resource:

```
hares -link cssd multipriv_resname
```

- 7 If the Oracle Clusterware/Grid Infrastructure and the Oracle database binaries are on CFS, set the dependencies between the CSSD resource and the CFSMount resources for the binaries manually:

```
hares -link cssd clusbin_mnt_resname
hares -link cssd orabin_mnt_resname
```

- 8 Change the permission on the VCS configuration file to read-only mode:

```
haconf -dump -makero
```

## Preventing automatic startup of Oracle Clusterware/Grid Infrastructure

The use of the CSSD agent is mandatory to ensure adequate handling of service group inter-dependencies and thereby prevent the premature startup of Oracle Clusterware/Grid Infrastructure. Therefore, disable automatic startup of Oracle Clusterware/Grid Infrastructure when the system starts.

### To prevent automatic startup of Oracle Clusterware/Grid Infrastructure

- 1 Log in as the root user on each node in the cluster.
- 2 Disable automatic startup of Oracle Clusterware/Grid Infrastructure.

For Oracle RAC 10g Release 2:

```
$CRS_HOME/bin/crsctl disable crs
```

For Oracle RAC 11g Release 2:

```
$GRID_HOME/bin/crsctl disable crs
```

## Relinking the SF Oracle RAC libraries with Oracle RAC

If you added or upgraded the Oracle patches, you must relink the SF Oracle RAC libraries to Oracle. If you are using Oracle RAC 10g, you need to link Oracle RAC with VCSIPC, VCSMM, and ODM libraries. If you are using Oracle RAC 11g, you need to link Oracle RAC with VCSMM and ODM libraries. Relinking the libraries enables coordinated exchange of cluster membership information and protection of data.

---

**Note:** Symantec recommends that you relink the SF Oracle RAC libraries only after completing all the required patch additions, if any.

This release does not support Oracle RAC 11g Release 1 Clusterware. References to Oracle RAC 11g Release 1 in the procedures apply to the Oracle database alone.

---

Use one of the following ways to relink the libraries:

|                                      |                                                                                                                                         |
|--------------------------------------|-----------------------------------------------------------------------------------------------------------------------------------------|
| SF Oracle RAC script-based installer | See <a href="#">“Relinking the SF Oracle RAC libraries with Oracle RAC using the SF Oracle RAC script-based installer”</a> on page 328. |
| SF Oracle RAC Web-based installer    | See <a href="#">“Relinking the SF Oracle RAC libraries with Oracle RAC using the SF Oracle RAC Web-based installer”</a> on page 329.    |
| Manual                               | See <a href="#">“Relinking the SF Oracle RAC libraries with Oracle RAC manually”</a> on page 330.                                       |

## Relinking the SF Oracle RAC libraries with Oracle RAC using the SF Oracle RAC script-based installer

Perform the steps in the following procedure to relink the libraries using the SF Oracle RAC script-based installer.

### To relink the SF Oracle RAC libraries with Oracle RAC

**1 Return to the SF Oracle RAC installer menu, and select the option **Post Oracle Installation**.**

- 1) Configure SF Oracle RAC sub-components
- 2) Prepare to Install Oracle
- 3) Install Oracle Clusterware/Grid Infrastructure and Database
- 4) Post Oracle Installation Tasks
- 5) Exit SF Oracle RAC Configuration

Choose option: [1-5,q] (1) **4**

**2 Select the option **Relink Oracle Database Binary**.**

- 1) Configure CSSD agent
- 2) Relink Oracle Database Binary
- 3) Exit SF Oracle RAC Configuration

b) Back to previous menu

Choose option: [1-3,b,q] (1) **2**



- 3 Provide the Oracle environment information—user name, group name, CRS\_HOME (or GRID\_HOME), ORACLE\_HOME. Based on this information, the installer detects the version of Oracle installed.

---

**Note:** You need to provide the Oracle environment information only if you quit the installer after installing Oracle Clusterware/Grid Infrastructure and the Oracle database.

---

```
Enter Oracle UNIX user name: [b] oracle
Enter Oracle UNIX group name: [b] (oinstall)
Enter absolute path of Oracle Clusterware/Grid Infrastructure
Home directory: [b]
Enter absolute path of Oracle Database Home directory: [b]
.
.
Do you want to continue? [y,n,q] (y)
```

- 4 Review and confirm the Oracle database information.  
 The installer starts relinking the libraries.

## Relinking the SF Oracle RAC libraries with Oracle RAC using the SF Oracle RAC Web-based installer

Perform the steps in the following procedure to relink the libraries using the SF Oracle RAC Web-based installer.

### To relink the SF Oracle RAC libraries with Oracle RAC

- 1 Start the Web-based installer.  
 See [“Starting the Veritas Web-based installer”](#) on page 122.
- 2 Select the following menu options from the Select a task and product page:

|                |                                                  |
|----------------|--------------------------------------------------|
| <b>Task</b>    | <b>Configure a Product</b>                       |
| <b>Product</b> | <b>Veritas Storage Foundation for Oracle RAC</b> |

Click **Next**.

- 3 Indicate the systems on which to install. Enter one or more system names, separated by spaces. Click **Next**.
- 4 After the validation completes successfully, click **Next**.

- 5 Select **Post Oracle Installation Tasks** from the Select a Task page. Click **Next**.
- 6 Select **Relink Oracle Database Binary** from the Select a Task page. Click **Next**.
- 7 Provide the following information:

**Enter Oracle UNIX user name** Oracle RAC 10g Release 2/Oracle RAC 11g Release 1:  
 For example, **oracle**  
 For Oracle RAC 11g Release 2:  
 For example, **grid**

**Enter Oracle UNIX group name** For example, **oinstall**

**Enter absolute path of Oracle Clusterware/Grid Infrastructure Home directory** Enter the full path of the Oracle Clusterware/Grid Infrastructure home directory.

**Enter absolute path of Oracle Database Home directory** Enter the full path of the Oracle database home directory.

Click **Next**. Confirm the detected Oracle version to proceed.

---

**Note:** You need to provide the Oracle environment information only if you quit the installer after installing Oracle Clusterware/Grid Infrastructure and the Oracle database.

---

- 8 Review and confirm the Oracle database information.  
 The installer starts relinking the libraries.

## Relinking the SF Oracle RAC libraries with Oracle RAC manually

If you added or upgraded the Oracle patches, you must relink the SF Oracle RAC libraries to Oracle. You must enable Oracle to use the Veritas ODM and cluster membership (VCSMM) libraries.

---

**Note:** Symantec recommends that you relink the SF Oracle RAC libraries only after completing all the required patch additions.

---

To relink the SF Oracle RAC libraries with Oracle RAC, run the following command as the oracle user:

```
$ /opt/VRTSvcs/rac/bin/linkrac oracle_version
```

Where `oracle_version` is 10gR2, 11gR1, or 11gR2 depending on the version of Oracle RAC you installed.

For example, to relink the SF Oracle RAC libraries with Oracle RAC 11g Release 2, run the following command as the oracle user:

```
$ /opt/VRTSvcs/rac/bin/linkrac 11gR2
```

## Verifying whether Oracle uses Veritas libraries

After relinking the libraries, you must verify whether Oracle uses Veritas libraries.

### To verify whether Oracle uses Veritas libraries

- 1 On each node, start the Oracle service group:

```
hagrps -online oracle_grp -sys node_name
```

- 2 After starting Oracle instances, confirm that Oracle uses the Veritas libraries.

On each node in the cluster, examine the Oracle alert file, `alert_$(ORACLE_SID).log`, for the following lines:

```
Oracle instance running with ODM: Veritas 6.0 ODM Library,
Version 2.0
```

Additionally, for Oracle RAC 10g, verify that the cluster interconnect IPC version is `VERITAS IPC 6.0.100.000`.

## Creating the Oracle RAC database

Create the Oracle RAC database on CVM raw volumes or CFS. Use your own tools or scripts, or review the guidelines on using the Oracle DBCA (Database Creation Assistant) tool to create the database.

For instructions on creating an Oracle RAC database:

See [“About creating a test database”](#) on page 598.

For more information, see the Oracle RAC documentation.

---

**Note:** If you plan to configure global clusters, then set up the Oracle RAC database only on the primary site. On the secondary site, the database will be replicated.

---

---

**Note:** For Oracle RAC 10g Release 2/Oracle RAC 11g Release 1: Make sure that you configure the database for availability if the database cache fusion traffic is configured to use Oracle UDP IPC private IP addresses and if these addresses are configured as a PrivNIC or MultiPrivNIC resource.

See [“Adding Oracle UDP IPC private IP addresses to the Oracle initialization parameter file”](#) on page 332.

---

## Adding Oracle UDP IPC private IP addresses to the Oracle initialization parameter file

Perform this step only for Oracle RAC 10 Release 2/Oracle RAC 11 Release 1 installations.

Add the Oracle UDP IPC private IP addresses to the Oracle initialization parameter file (for example, `pfile` or `spfile`) if the database cache fusion traffic is configured to use Oracle UDP IPC private IP addresses and if these addresses are configured as a PrivNIC or MultiPrivNIC resource for high availability. You need to configure the `cluster_interconnects` parameter in the Oracle initialization parameter file to use the appropriate private IP addresses.

**To add Oracle UDP IPC private IP addresses to the initialization parameter file**

- 1 Log in as the Oracle user on one of the nodes in the cluster.
- 2 Perform this step only for Oracle RAC 11.2.0.1 and earlier versions.

Set the `cluster_interconnects` parameter in the Oracle initialization parameter file to use the Oracle UDP IPC private IP addresses that are used for database cache fusion and are managed by PrivNIC or MultiPrivNIC.

---

**Note:** Configure multiple IP addresses for each database instance in the `cluster_interconnects` parameter to distribute the database cache fusion traffic across multiple links.

---

```
$ sqlplus '/ as sysdba'
```

```
SQL> alter system set cluster_interconnects='192.168.2.1:192.168.3.1' \
scope=spfile sid='oradb_sid_node1';
SQL> alter system set cluster_interconnects='192.168.2.2:192.168.3.2' \
scope=spfile sid='oradb_sid_node2';
SQL> exit;
```

- 3 Stop the Oracle database on all nodes:

If the database is configured under VCS:

```
hares -offline db_resname -sys node_name
```

If the database is not configured under VCS:

```
$ srvctl stop database -d db_name
```

- 4 For Oracle RAC 10g: Unlink the Veritas VCS IPC library.

Perform this step on each node if the Oracle libraries are on local storage. If the Oracle libraries are installed on shared storage, perform the step on one node only.

```
$ cd $ORACLE_HOME/rdbms/lib
```

```
$ make -f ins_rdbms.mk rac_on
```

```
$ make -f ins_rdbms.mk ioracle
```

- 5 As the Oracle user on one of the nodes in the cluster, restart the Oracle database:

```
$ srvctl start database -d db_name
```

- 6 As the root user on each node in the cluster, verify that the private IP addresses are running.

```
ifconfig lan1
```

## Configuring VCS service groups for Oracle RAC

Before you configure VCS service groups for Oracle databases, review the following information:

- Supported types of database management  
See [“Supported types of database management”](#) on page 334.
- Sample service group configurations  
See [“Sample service group configurations”](#) on page 335.

To configure the VCS service groups for Oracle RAC:

See [“Configuring VCS service groups manually for Oracle databases”](#) on page 339.

## Supported types of database management

[Table 23-1](#) lists the database management options in Oracle RAC that are supported by SF Oracle RAC.

**Table 23-1** Supported types of database management

| Management type                 | Description                                                                                                                                                                                                                                               |
|---------------------------------|-----------------------------------------------------------------------------------------------------------------------------------------------------------------------------------------------------------------------------------------------------------|
| Policy-managed databases        | In policy-managed databases, administrators specify the server pool on which the database instances run. Oracle Grid Infrastructure determines the server on which the database instances run.<br><br>For more information, see the Oracle documentation. |
| Administrator-managed databases | In administrator-managed databases environments, the administrator specifies the servers on which the databases instances run.<br><br>For more information, see the Oracle documentation.                                                                 |

## Sample service group configurations

You can set up the Oracle database to be managed by one of the following clusterwares:

- Veritas Cluster Server

---

**Note:** Symantec recommends that the Oracle database be configured under VCS.

---

When the database is configured under VCS:

You can choose to configure the service group in a way that insulates all the databases from failure in any of the databases in the group.

VCS manages the start and stop sequence of the applications and the database.

See [“Sample service group configurations with the VCS Oracle agent”](#) on page 335.

- Oracle Clusterware/Grid Infrastructure  
See [“Sample service group configurations without the VCS Oracle agent”](#) on page 338.

### Sample service group configurations with the VCS Oracle agent

This section illustrates sample service group configurations with the VCS Oracle agent for multiple databases.

[Figure 23-2](#) illustrates a service group configuration with the VCS Oracle agent.

**Figure 23-2** Service group configuration with the VCS Oracle agent

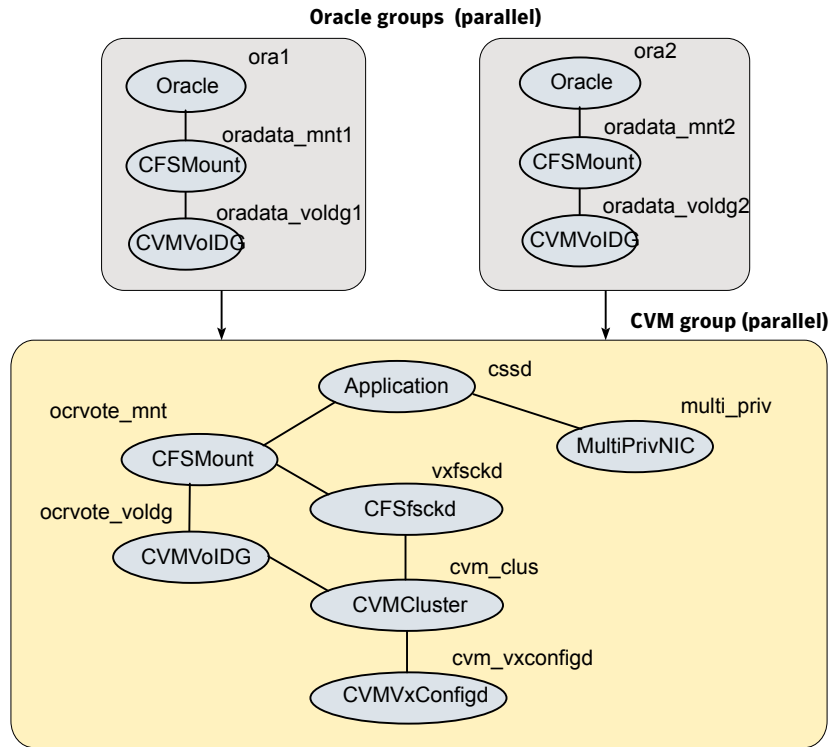

**Figure 23-3** illustrates an alternate service group configuration with the VCS Oracle agent.



**Figure 23-3** Service group configuration with the VCS Oracle agent (alternate configuration)

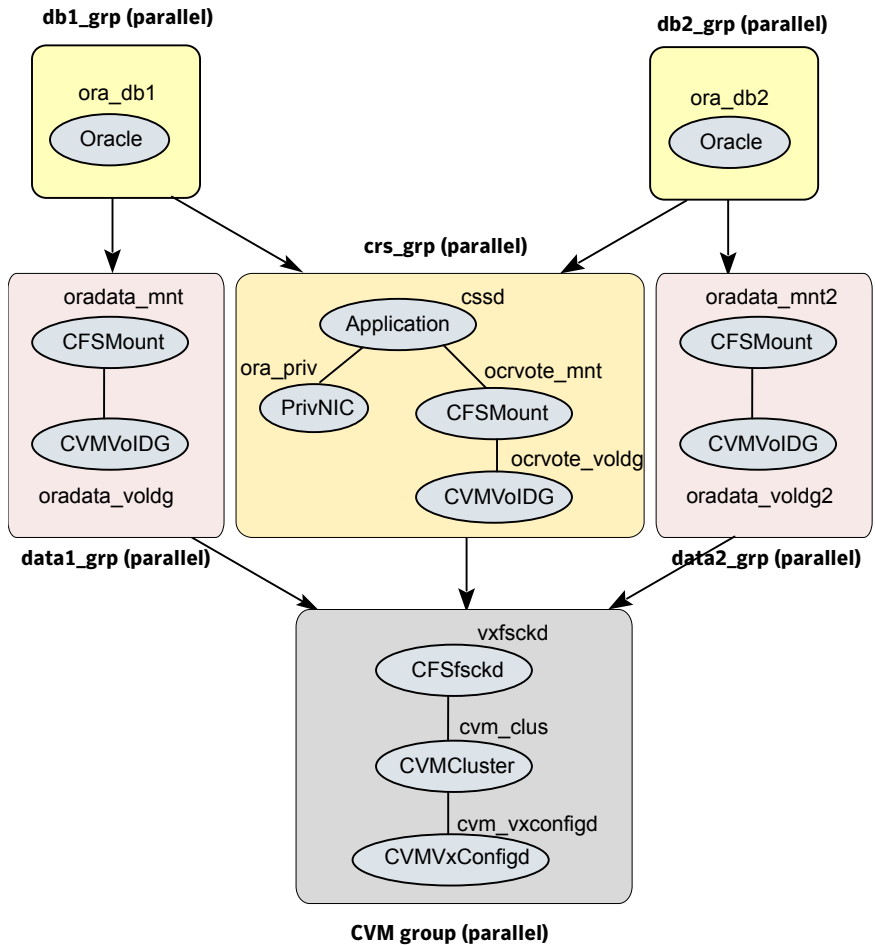

To configure the Oracle database under VCS, create Oracle service groups after installing Oracle RAC and creating a database.

See [“Configuring VCS service groups manually for Oracle databases”](#) on page 339.

## Sample service group configurations without the VCS Oracle agent

Figure 23-4 illustrates a sample configuration in the absence of the VCS Oracle agent for single database configurations.

**Figure 23-4** Service group configuration without VCS Oracle agent (single database)

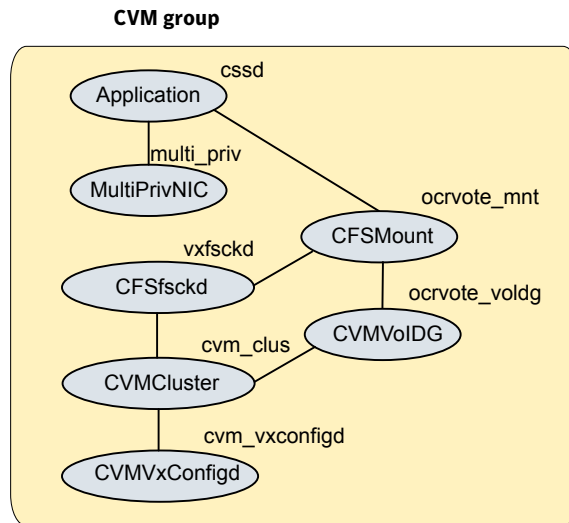
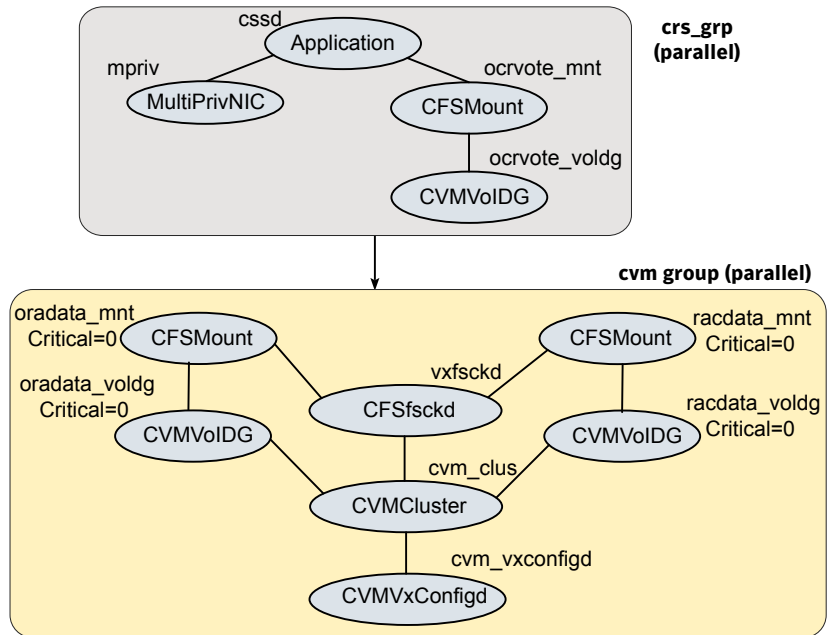

Figure 23-5 illustrates a sample service group configuration in the absence of the VCS Oracle agent for multiple database configurations.

**Figure 23-5** Service group configuration without the VCS Oracle agent (multiple databases)



In a service group configuration without the VCS Oracle agent, Oracle Clusterware/Grid Infrastructure controls the database. An online local firm dependency exists between the Oracle Clusterware/Grid Infrastructure group and the CVM group. When the system starts, the CVM group brings up the volume and mount points for the databases. The Oracle Clusterware/Grid Infrastructure group brings up the OCR and voting disk, configures the private IP address for Oracle Clusterware/Grid Infrastructure, and starts Oracle Clusterware/Grid Infrastructure. Oracle Clusterware/Grid Infrastructure starts the database and the application is brought online.

---

**Note:** In a service group configuration without the VCS Oracle agent, when the system starts, all volumes and mount points MUST be online for the dependent service groups to be online.

---

## Configuring VCS service groups manually for Oracle databases

This section describes the steps to configure the VCS service group manually for Oracle databases.

See [Figure 23-2](#) on page 336.

The following procedure assumes that you have created the database.

### To configure the Oracle service group manually for Oracle databases

- 1 Change the cluster configuration to read-write mode:

```
haconf -makerw
```

- 2 Add the service group to the VCS configuration:

```
hagrps -add oradb_grpname
```

- 3 Modify the attributes of the service group:

```
hagrps -modify oradb_grpname Parallel 1
```

```
hagrps -modify oradb_grpname SystemList node_name1 0 node_name2 1
```

```
hagrps -modify oradb_grpname AutoStartList node_name1 node_name2
```

- 4 Add the CVMVolDg resource for the service group:

```
hares -add oradb_dg_resname CVMVolDg oradb_grpname
```

- 5 Modify the attributes of the CVMVolDg resource for the service group:

```
hares -modify oradb_dg_resname CVMDiskGroup oradb_dgname
```

```
hares -modify oradb_dg_resname CVMActivation sw
```

```
hares -modify oradb_dg_resname CVMVolume oradb_volname
```

- 6 Add the CFMount resource for the service group:

```
hares -add oradb_mnt_resname CFMount oradb_grpname
```

- 7 Modify the attributes of the CFMount resource for the service group:

```
hares -modify oradb_mnt_resname MountPoint "oradb_mnt"
```

```
hares -modify oradb_mnt_resname BlockDevice \
```

```
"/dev/vx/dsk/oradb_dgname/oradb_volname"
```

- 8 Add the Oracle RAC database instance to the service group:

```
hares -add db_resname Oracle oradb_grpname
```

9 Modify the attributes of the Oracle resource for the service group:

```
hares -modify db_resname Owner oracle
hares -modify db_resname Home "db_home"
hares -modify db_resname StartUpOpt SRVCTLSTART
hares -modify db_resname ShutDownOpt SRVCTLSTOP
```

10 For administrator-managed databases, perform the following steps:

- Localize the Sid attribute for the Oracle resource:

```
hares -local db_resname Sid
```

- Set the Sid attributes for the Oracle resource on each system:

```
hares -modify db_resname Sid oradb_sid_node1 -sys node_name1
hares -modify db_resname Sid oradb_sid_node2 -sys node_name2
```

11 For policy-managed databases, perform the following steps:

- Modify the attributes of the Oracle resource for the service group:

```
hares -modify db_resname DBName db_name
hares -modify db_resname ManagedBy POLICY
```

- Set the Sid attribute to the Sid prefix for the Oracle resource on all systems:

```
hares -modify db_resname Sid oradb_sid_prefix
```

---

**Note:** The Sid prefix is displayed on the confirmation page during database creation. The prefix can also be determined by running the following command :

```
grid_home/bin/crsctl status resource ora.db_name.db -f | grep
GEN_USR_ORA_INST_NAME@ | tail -1 | sed 's/.*=//' | sed
's/_[0-9]$/'
```

---

- Set the IntentionalOffline attribute for the resource to 1 and make sure that the health check monitoring is disabled:

```
hares -override db_resname IntentionalOffline
hares -modify db_resname IntentionalOffline 1
hares -modify db_resname MonitorOption 0
```

- 12 Set the dependencies between the CFSSMount resource and the CVMVolDg resource for the Oracle service group:

```
hares -link oradbmnt_resname oradb_dg_resname
```

- 13 Set the dependencies between the Oracle resource and the CFSSMount resource for the Oracle service group:

```
hares -link db_resname oradbmnt_resname
```

- 14 Create an online local firm dependency between the oradb1\_grp service group and the cvm service group:

```
hagrps -link oradb_grpname cvm_grpname online local firm
```

- 15 Enable the Oracle service group:

```
hagrps -enableresources oradb_grpname
```

- 16 Change the cluster configuration to the read-only mode:

```
haconf -dump -makero
```

- 17 Bring the Oracle service group online on all the nodes:

```
hagrps -online oradb_grpname -any
```

---

**Note:** For policy-managed databases: When VCS starts or when the administrator attempts to bring the Oracle resource online, if the server is not part of the server pool associated with the database, the resource will remain offline. If Oracle Grid Infrastructure decides to move the server from the server pool, the database will be brought offline by the Oracle Grid Infrastructure and the oracle resource moves to offline state.

---

For more information and instructions on configuring the service groups using the CLI:

See the *Veritas Cluster Server Administrator's Guide*.

## Managing database restart after failure

When a database instance faults, it is observed that both Oracle Clusterware and VCS (through the Oracle agent) respond to the resource fault. When Oracle Clusterware detects an instance failure, it attempts to restart the instance based

on the value set for the `RESTART_ATTEMPTS` attribute in the database resource profile of Oracle Clusterware. At the same time, VCS detects the instance failure and faults the resource and takes action depending on the VCS configuration.

To avoid both clusterwares from independently responding to the fault, you need to modify the appropriate resource parameters as described in the following sections.

### To manage database restart after failure

- 1 Log into one of the nodes in the cluster as the root user.
- 2 Perform one of the following steps:
  - Disable Oracle Clusterware/Grid Infrastructure from restarting the instance by modifying the `RESTART_ATTEMPTS` attribute as follows:  
For Oracle RAC 10g Release 2/Oracle RAC 11g Release 1:  
Retrieve the Oracle database resource profile by running the following command:

```
crs_stat -p db_resname > \
$CRS_HOME/crs/public/db_resname.cap
```

Set the `RESTART_ATTEMPTS` attribute to 0:

```
RESTART_ATTEMPTS=0
```

Register the changes to the Oracle database resource profile by running the following command:

```
crs_register -u dbres_name
```

For Oracle RAC 11g Release 2:

```
crsctl modify resource db_resname -attr "RESTART_ATTEMPTS=0"
```

- Prevent VCS from faulting the resource until Oracle Clusterware/Grid Infrastructure exhausts its restart attempts.

```
haconf -makerw
hares -modify db_resname ToleranceLimit = tl_value
haconf -dump -makero
```

where `tl_value` is a value greater than or equal to the value of the `RESTART_ATTEMPTS` attribute.

## Location of VCS log files

You may want to review the log files at `/var/VRTSvcs/log/engine_A.log` for errors or status messages. When large amounts of data are written, multiple log files may be written, such as `engine_B.log`, `engine_C.log`, and so on. The `engine_A.log` contains the most recent data.

## Preventing automatic database startup

Configure the Oracle RAC database for manual startup if you want the Oracle RAC database to be managed by VCS using the Oracle agent. If you configure the VCS service groups for Oracle, you need to prevent the Oracle database from starting automatically. The Oracle Clusterware/Grid Infrastructure and Oracle agent may attempt to start the database instance at the same time if the database mount is available. To prevent the Oracle database from starting automatically, you must change the management policy for the database from automatic to manual using the Oracle `SRVCTL` command. The command changes the `AUTO_START` attribute of the Oracle database and instance resources.

### To prevent automatic database startup

- 1 Register the database, if not already registered.

```
$ srvctl add database -d db_name -o db_home \
-p location_parameterfile -y manual
```

- 2 Once the database is registered, change the management policy for the database to manual.

---

**Note:** For Oracle RAC 11g Release 2 policy-managed databases, retain the default management policy, which is `automatic`.

---

```
$ srvctl stop database -d db_name
$ srvctl modify database -d db_name -y manual
```

- 3 Start the database.

```
$ srvctl start database -d db_name
```



## Removing permissions for communication

Make sure you completed the installation of SF Oracle RAC and the verification of disk support for I/O fencing. If you used `remsh`, remove the temporary `remsh` access permissions that you set for the nodes and restore the connections to the public network.

If the nodes use `ssh` for secure communications, and you temporarily removed the connections to the public network, restore the connections.

## Configuring the Storage Foundation for Databases repository database after installation

If you want to use Storage Foundation for Databases (SFDB), you must set up the SFDB repository after installing and configuring SF Oracle RAC and Oracle. For SFDB repository set up procedures:

See *Veritas Storage Foundation: Storage and Availability Management for Oracle Databases*

# Upgrading Oracle RAC

This chapter includes the following topics:

- [Supported upgrade paths](#)
- [Preparing to upgrade Oracle RAC](#)
- [Upgrading Oracle RAC binaries](#)
- [Migrating the Oracle RAC database](#)

## Supported upgrade paths

Oracle RAC 11g Release 1 Clusterware is not supported. Make sure that you install Oracle RAC 11g Release 2 Grid Infrastructure in order to use the Oracle RAC 11g Release 1 database. All database versions starting from Oracle 10g Release 2 and later are supported.

[Table 24-1](#) lists the upgrade paths for Oracle RAC.

**Table 24-1** Supported upgrade paths for Oracle RAC

| From current version     | Upgrade to                                                                                                                                 |
|--------------------------|--------------------------------------------------------------------------------------------------------------------------------------------|
| Oracle RAC 9i Release 2  | Oracle RAC 10g Release 2<br>Oracle RAC 11g Release 2 Grid Infrastructure and Oracle RAC 11g Release 1 database                             |
| Oracle RAC 10g Release 1 | Oracle RAC 10g Release 2<br>Oracle RAC 11g Release 2 Grid Infrastructure and Oracle RAC 11g Release 1 database<br>Oracle RAC 11g Release 2 |

**Table 24-1** Supported upgrade paths for Oracle RAC (*continued*)

| From current version     | Upgrade to                                                                                                     |
|--------------------------|----------------------------------------------------------------------------------------------------------------|
| Oracle RAC 10g Release 2 | Oracle RAC 11g Release 2 Grid Infrastructure and Oracle RAC 11g Release 1 database<br>Oracle RAC 11g Release 2 |
| Oracle RAC 11g Release 1 | Oracle RAC 11g Release 2                                                                                       |

---

**Note:** When you upgrade to a different version of Oracle RAC, make sure that the full path of the Oracle Clusterware/Grid Infrastructure home directory and the Oracle database home directory is different from the path where the existing version of Oracle RAC resides.

---

The upgrade procedure assumes that the beginning configuration includes the following components, and that these components are running on the cluster nodes:

- SF Oracle RAC 6.0.1
- A supported version of the operating system

## Preparing to upgrade Oracle RAC

Complete the following preparatory tasks before you upgrade Oracle RAC:

1. Depending on the version you are upgrading from, perform the steps in one of the following sections:
  - See [“Preparing to upgrade from Oracle RAC 10g or Oracle RAC 11g”](#) on page 347.
  - See [“Preparing to upgrade from Oracle RAC 9i”](#) on page 348.
2. Verify that the cluster configuration is compatible for upgrading Oracle RAC.

### Preparing to upgrade from Oracle RAC 10g or Oracle RAC 11g

Perform the following tasks before upgrading Oracle RAC.

### To prepare for upgrade from Oracle RAC 10g or Oracle RAC 11g

- 1 Take a hot or cold backup of the existing database.
- 2 Back up the existing Oracle home and central inventory.
- 3 If the Oracle RAC database is under VCS control, freeze the Oracle service groups to prevent VCS from reporting the resource as faulted when Oracle RAC stops and starts the database during the upgrade:

```
haconf -makerw

hagrps -freeze oradb_grpname -persistent

haconf -dump -makero
```

## Preparing to upgrade from Oracle RAC 9i

Perform the following pre-upgrade tasks before upgrading from Oracle RAC 9i.

### To prepare for upgrade from Oracle RAC 9i

- 1 Take a hot or cold backup of the existing Oracle RAC 9i Release 2 database.
- 2 Back up the existing Oracle Home and Central Inventory.
- 3 If the Oracle RAC database is under VCS control, freeze the Oracle service groups to prevent VCS from reporting the resource as faulted when Oracle RAC stops and starts the database during the upgrade:

```
haconf -makerw

hagrps -freeze oradb_grpname -persistent

haconf -dump -makero
```

- 4 As the "Oracle" user, stop the Global Services Daemon, GSD:

```
$ $ORACLE_HOME/bin/gsdctl stop
```

- 5 Perform the following pre-installation steps:
  - Identify the public virtual addresses for use by Oracle
  - Set the kernel tunables and other parameters
  - Configure private IP addresses for Oracle RAC
  - Create voting disk volumes and mount points
  - Set up Oracle user equivalence

For instructions on performing the tasks, see the chapter *Before installing Oracle RAC* in this guide.

## Upgrading Oracle RAC binaries

Review your Oracle installation manuals and the appropriate Oracle support Web sites before upgrading Oracle RAC.

---

**Note:** If you upgrade to Oracle RAC 11g Release 2, make sure that you upgrade with the same user credentials as that of the existing installation.

---

### To upgrade Oracle RAC binaries

- 1 Upgrade Oracle Clusterware.

---

**Note:** If you upgrade to Oracle RAC 11g Release 2, upgrade Oracle Clusterware to a new directory called the Oracle Grid Infrastructure home directory (GRID\_HOME).

Starting with Oracle RAC 11g Release 2, ASM must reside in the Oracle Grid Infrastructure home directory. If you plan to upgrade ASM to Oracle RAC 11g Release 2, make sure that you upgrade it to run in the Oracle Grid Infrastructure home directory.

---

For instructions, see the Oracle RAC documentation.

- 2 Make sure that Oracle Clusterware is running.
- 3 Install the Oracle RAC database binaries.

For instructions, see the Oracle RAC documentation.

- 4 Complete the following post-installation tasks:
  - Add Oracle RAC patches or patchsets.  
See [“Adding Oracle RAC patches or patchsets”](#) on page 320.
  - Relink the SF Oracle RAC libraries with Oracle RAC.  
See [“Relinking the SF Oracle RAC libraries with Oracle RAC”](#) on page 327.
  - For upgrades from Oracle RAC 9i: Add the CSSD resource to the VCS configuration.  
See [“Configuring the CSSD resource”](#) on page 321.

# Migrating the Oracle RAC database

For instructions on migrating the existing Oracle RAC database, see the Oracle metalink documentation.

After migrating the database, complete the post-upgrade tasks:

See [“Performing post-upgrade tasks”](#) on page 350.

## Performing post-upgrade tasks

Perform the steps in the following procedure to complete the upgrade.

### To perform post-upgrade tasks

- 1 Change the cluster configuration to read-write mode:

```
haconf -makerw
```

- 2 For upgrades from Oracle RAC 9i: Modify the resources in the Oracle service groups:

```
hares -modify db_resname StartUpOpt SRVCTLSTART
hares -modify db_resname ShutDownOpt SRVCTLSTOP
hares -modify db_resname pfile "" -sys node_name1
hares -modify db_resname pfile "" -sys node_name2
```

- 3 Add the Oracle UDP IPC private IP addresses to the Oracle `init.ora` file if the database cache fusion traffic is configured to use Oracle UDP IPC private IP addresses and if these addresses are configured as a PrivNIC or MultiPrivNIC resource for high availability.

See [“Adding Oracle UDP IPC private IP addresses to the Oracle initialization parameter file”](#) on page 332.

- 4 Modify the Oracle RAC configuration to prevent automatic startup of Oracle Clusterware.

See [“Preventing automatic startup of Oracle Clusterware/Grid Infrastructure”](#) on page 327.

- 5 Modify the Oracle RAC database configuration to prevent automatic database startup if you want the Oracle RAC database to be managed by VCS using the Oracle agent.

See [“Preventing automatic database startup”](#) on page 344.

## 6 Unfreeze the VCS service groups that were frozen earlier.

As root user, enter:

```
hagrps -unfreeze oradb_grpname -persistent
hagrps -unfreeze cvm_grpname -persistent
haconf -dump -makero
```

## 7 Migrate OCR and voting disk to CFS or ASM.

For migrating OCR and voting disk to CFS:

- Create the required storage on CFS.  
For instructions:  
See [“Creating the OCR and voting disk storage on CFS”](#) on page 255.
- Migrate OCR and voting disk to CFS.  
For instructions, see the Oracle documentation.

For instructions on migrating OCR and voting disk to ASM, see the Oracle documentation.

# Automated installation using response files

- [Chapter 25. About response files](#)
- [Chapter 26. Installing and configuring SF Oracle RAC using a response file](#)
- [Chapter 27. Performing an automated I/O fencing configuration using response files](#)
- [Chapter 28. Installing Oracle RAC using a response file](#)



# About response files

This chapter includes the following topics:

- [About response files](#)
- [Response file syntax](#)
- [Guidelines for creating the SF Oracle RAC response file](#)
- [Installation scenarios for response files](#)

## About response files

Use response files to standardize and automate installations on multiple clusters.

You can perform the following installation activities using a response file:

- Installing and configuring SF Oracle RAC
- Preparing the nodes for installation of Oracle RAC
- Installing Oracle RAC
- Relinking the SF Oracle RAC libraries with Oracle RAC
- Configuring the CSSD agent
- Upgrading SF Oracle RAC
- Uninstalling SF Oracle RAC

You can perform end-to-end installations or modular deployments.

For more information on modular deployments:

See [“Modular deployments using response files”](#) on page 354.

[Table 25-1](#) lists the various options available for creating or obtaining a response file.

**Table 25-1** Options for obtaining a response file

| Option                                                             | Description                                                                                                                                                                                                                                                                                                                                                                                                                                                                                                                                                                                                                                                                                                                                                                                                                                                                                                                                                                                                                                                                                                                      |
|--------------------------------------------------------------------|----------------------------------------------------------------------------------------------------------------------------------------------------------------------------------------------------------------------------------------------------------------------------------------------------------------------------------------------------------------------------------------------------------------------------------------------------------------------------------------------------------------------------------------------------------------------------------------------------------------------------------------------------------------------------------------------------------------------------------------------------------------------------------------------------------------------------------------------------------------------------------------------------------------------------------------------------------------------------------------------------------------------------------------------------------------------------------------------------------------------------------|
| Create a response file                                             | <p>Create a response file based on the response file template provided with SF Oracle RAC.</p> <p>The file is located at <code>/opt/VRTSvcs/rac/install</code>.</p>                                                                                                                                                                                                                                                                                                                                                                                                                                                                                                                                                                                                                                                                                                                                                                                                                                                                                                                                                              |
| Reuse or customize the response files generated by an installation | <p>The Veritas installation programs generate a response file during the installation, configuration, upgrade, or uninstallation of SF Oracle RAC and for installer-based pre-installation tasks for Oracle RAC.</p> <p>The response file generated by the installer is located in the following directory:</p> <pre data-bbox="580 633 1220 685">/opt/VRTS/install/logs/installsfrac&lt;version&gt;-\<br/>installernumber/installsfrac&lt;version&gt;-installernumber.respon</pre> <p>You can reuse or customize the response files to perform a complete end-to-end installation or to perform a specialized activity, such as setting up the PrivNIC or MultiPrivNIC configuration on your clusters. All you need to do is update the response file variable definitions to enable or disable the options, depending on the task you want to perform.</p> <p><b>Note:</b> Response files are not created if the tasks terminated abruptly or if you entered <b>q</b> to quit the installation. To generate the response file when you plan to discontinue a task, use the <b>Exit SF Oracle RAC configuration</b> option.</p> |

At the end of the SF Oracle RAC installation, the following files are created:

- A log file that contains executed system commands and output.
- A summary file that contains the output of the installation scripts.
- Response files to be used with the `-responsefile` option of the installer.

**Note:** The SF Oracle RAC response files also contain VCS variables used for the installation and configuration of VCS.

For the VCS variable definitions, see the *Veritas Cluster Server Installation Guide*.

## Modular deployments using response files

Modular deployments offer flexibility in planning your installation and configuration activities. You can choose to perform any installation or configuration task

independent of other related activities. For example, you can disable Oracle user and group creation across all nodes in a cluster while installing Oracle RAC.

Modular deployments are supported for the following installation and configuration activities:

- Installing SF Oracle RAC
- Configuring SF Oracle RAC
- Creating Oracle user and group
- Creating storage for OCR and voting disk
- Configuring private IP addresses for Oracle RAC
- Installing Oracle Clusterware
- Installing Oracle database
- Oracle post-installation tasks:
  - Configuring CSSD agent
  - Relinking Oracle RAC libraries

The variables required for each of the above tasks are described in the chapter *Response file variable definitions* of this document.

All modular deployment activities require the following variable definitions:

```
$CFG{prod}
$CFG{systems}
```

## Response file syntax

The Perl statement syntax that is included in the response file varies, depending on whether “Scalar” or “List” values are required by the variables.

For example,

```
$CFG{Scalar_variable}="value";
```

or, in the case of an integer value:

```
$CFG{Scalar_variable}=123;
```

or, in the case of a list:

```
$CFG{List_variable}=["value", "value", "value"];
```

# Guidelines for creating the SF Oracle RAC response file

This section provides guidelines for creating the SF Oracle RAC response file.

1. Create a response file using one of the available options.

For various options on creating or obtaining an SF Oracle RAC response file:

See [“About response files”](#) on page 353.

2. Set the following master values to 1 to enable SF Oracle RAC installation and configuration.

---

**Note:** The master settings must be set to 1 to enable the installer to read dependent variable definitions. For example, if the value `$CFG{opt}{install}` is not set to 1, the other dependent installation values in the response file will be disregarded. This is true for any master setting.

---

The following is the list of master values that must be set for installing and configuring SF Oracle RAC.

Installing SF Oracle RAC    `$CFG{opt}{install}=1;`

Configuring SF Oracle RAC    `$CFG{opt}{configure}=1;`  
                                  `$CFG{config_sfrac_subcomponents}=1;`

3. Now, set the appropriate value in the dependent variable definitions for installing and configuring SF Oracle RAC.

The set of minimum definitions for a successful installation and configuration is as follows:

```
$CFG{accepteula}=1;
$CFG{opt}{install}=1;
$CFG{opt}{configure}=1;
$CFG{config_sfrac_subcomponents}=1;
$CFG{opt}{installallpkgs}=1;
$CFG{opt}{vxkeyless}=1;
$CFG{prod}="SFRAC601";
$CFG{systems}=[qw(sys1 sys2)];
$CFG{vcs_allowcomms}=1;
$CFG{vcs_clusterid}=101;
```

```

$CFG{vcs_clustername}="clus1";
$CFG{vcs_11tlink1}{sys1}="lan1";
$CFG{vcs_11tlink1}{sys2}="lan1";
$CFG{vcs_11tlink2}{sys1}="lan2";
$CFG{vcs_11tlink2}{sys2}="lan2";
$CFG{vcs_userenpw}=[qw(gpqIpkPmqLqqOyqKpn)];
$CFG{vcs_username}=[qw(admin)];
$CFG{vcs_userpriv}=[qw(Administrators)];

```

You can add more variable definitions, as required.

4. Set the following master values to 1 to enable the Oracle pre-installation tasks.

---

**Note:** This step assumes that you have already set the master value `$CFG{opt}{configure}` to 1 in the previous step.

---

The following is the list of additional master values that must be set for completing Oracle pre-installation tasks:

|                                                     |                                                                                                                                                                                                                                                                                                              |
|-----------------------------------------------------|--------------------------------------------------------------------------------------------------------------------------------------------------------------------------------------------------------------------------------------------------------------------------------------------------------------|
| Private IP address configuration                    | <p>If you plan to use the PrivNIC agent, use the following master settings:</p> <pre> \$CFG{config_privnic}=1; \$CFG{config_multiprivnic}=0; </pre> <p>If you plan to use the MultiPrivNIC agent, use the following master settings:</p> <pre> \$CFG{config_multiprivnic}=1; \$CFG{config_privnic}=0; </pre> |
| OCR and voting disk storage                         | <pre> \$CFG{create_ocr_vote_storage}=1; </pre>                                                                                                                                                                                                                                                               |
| Oracle Clusterware/Grid Infrastructure installation | <pre> \$CFG{install_oracle_clusterware}=1; </pre>                                                                                                                                                                                                                                                            |
| Oracle database installation                        | <pre> \$CFG{install_oracle_database}=1; </pre>                                                                                                                                                                                                                                                               |
| Post Oracle tasks                                   | <pre> \$CFG{config_cssd_agent}=1; \$CFG{relink_oracle_database}=1; </pre>                                                                                                                                                                                                                                    |

Set the master value for the `$CFG{create_oracle_user_group}` variable to 0 as follows:

```
$CFG{create_oracle_user_group}=0;
```

---

**Note:** If you are performing an end-to-end installation, the creation of Oracle user and group must be completed before starting the installation. This is because user equivalence must be manually established on all nodes to allow the Oracle Universal Installer to securely copy files and run programs on the nodes in the cluster without requiring password prompts.

---

5. Set the appropriate value for the dependent variable definitions for the Oracle pre-installation tasks.

---

**Note:** The following table discusses the variable definitions with sample values. Replace the sample values with those that are appropriate for your installation requirements.

---

Private IP address configuration

If you plan to use the PrivNIC agent, provide the following definitions:

```
$CFG{privnic_resname} = "ora_priv";
$CFG{privnic_interface_priority}="lan2 lan3";
$CFG{sys1}{privnicip} = "192.168.12.1";
$CFG{sys1}{hostname_for_ip} = "sys1-priv";
$CFG{sys2}{privnicip} = "192.168.12.2";
$CFG{sys2}{hostname_for_ip} = "sys2-priv";
$CFG{nic_netmask} = "255.255.255.0";
$CFG{nic_add_ip_to_files} = 1;
```

If you plan to use the MultiPrivNIC agent, use the following master settings:

```
$CFG{multiprivnic_resname} = "ora_priv";
$CFG{nic_add_ip_to_files} = 1;
$CFG{sys1}{lan1}{multiprivnicip}
= "192.168.12.1";
$CFG{sys1}{lan1}{hostname_for_ip}
= "sys1-priv";
$CFG{sys1}{lan2}{multiprivnicip}
= "192.168.2.1";
$CFG{sys1}{lan2}{hostname_for_ip}
= "sys1-priv1";
$CFG{sys2}{lan1}{multiprivnicip}
= "192.168.12.2";
$CFG{sys2}{lan1}{hostname_for_ip}
= "sys2-priv";
$CFG{sys2}{lan2}{multiprivnicip}
= "192.168.2.2";
$CFG{sys2}{lan2}{hostname_for_ip}
= "sys2-priv1";
$CFG{nic_netmask} = "255.255.255.0";
```

**OCR and voting disk storage**    If you choose to create the OCR and voting disk storage:

```
$CFG{ocrvotedgoption}=0;
$CFG{ocrvotescheme} = 1;
$CFG{enable_mirroring} = 1;
$CFG{enable_sep_filesys} = 0
$CFG{ocrvotedisks} = [qw(Disk_1 Disk_2)];
$CFG{ocrvotedgname} = "ocrvotedg";
$CFG{ocrvotevolname} = "ocrvotevol";
$CFG{ocrvotevolsize} = 640;
$CFG{ocrvotemount} = "/ocrvote";
$CFG{oracle_user} = "oracle";
$CFG{oracle_group} = "oinstall";
```

**If you choose to use an existing storage for the OCR and voting disk storage:**

```
$CFG{ocrvotedgoption}=1;
$CFG{ocrvotescheme} = 0;
$CFG{enable_mirroring} = 1;
$CFG{ocrvotedgname} = "ocrvotedg";
$CFG{ocrvotevolname} = "ocrvotevol";
$CFG{ocrvotevolsize} = 640;
$CFG{ocrvotemount} = "/ocrvote";
$CFG{oracle_user} = "oracle";
$CFG{oracle_group} = "oinstall";
```

**Oracle Clusterware/Grid Infrastructure installation**

```
$CFG{grid_user}="oracle";
$CFG{oracle_group} = "oinstall";
$CFG{oracle_base} = "/u01/app/oracle";
$CFG{crs_home} = "/u01/app/11.2.0/grid";
$CFG{crs_installpath} = "/cdrom/oracle/\
clusterware";
$CFG{oracle_version} = "11.2.0.3";
$CFG{crs_responsefile} = "/oracle/crs.rsp";
```

**Oracle database installation**

```
$CFG{grid_user}="oracle";
$CFG{oracle_group} = "oinstall";
$CFG{oracle_base} = "/u01/app/oracle";
$CFG{crs_home} = "/u01/app/11.2.0/grid";
$CFG{db_home} = "/u02/app/oracle/product/\
11.2.0/dbhome_1";
$CFG{db_installpath} = "/cdrom/oracle/database";
$CFG{oracle_version} = "11.2.0.3";
$CFG{db_responsefile} = "/oracle/db.rsp";
```



Post Oracle tasks      The master value (set in the previous step) suffices for CSSD resource configuration.

For relinking libraries, the dependent variable settings are as follows:

```
$CFG{grid_user}="oracle";
$CFG{oracle_group} = "oinstall";
$CFG{crs_home} = "/u01/app/11.2.0/grid";
$CFG{db_home} = "/u02/app/oracle/product/\n11.2.0/dbhome_1";
$CFG{oracle_version} = "11.2.0.3";
```

## Installation scenarios for response files

The chapters in this section cover the following installation scenarios using response files:

- Installing and configuring SF Oracle RAC  
See [“Installing and configuring SF Oracle RAC”](#) on page 362.
- Installing Oracle RAC  
See [“About installing Oracle RAC using response files”](#) on page 389.
- Installing both SF Oracle RAC and Oracle RAC

# Installing and configuring SF Oracle RAC using a response file

This chapter includes the following topics:

- [Installing and configuring SF Oracle RAC](#)
- [Response file variables to install Veritas Storage Foundation for Oracle RAC](#)
- [Response file variables to configure Veritas Storage Foundation for Oracle RAC](#)
- [Sample response file for installing SF Oracle RAC](#)
- [Sample response file for configuring SF Oracle RAC](#)

## Installing and configuring SF Oracle RAC

You can create a single response file or separate response files for installing and configuring SF Oracle RAC.

The installer performs the following tasks:

- Installs SF Oracle RAC.
- Configures SF Oracle RAC.

The following sample procedure uses a single response file for installing and configuring SF Oracle RAC.

### To install and configure SF Oracle RAC using response files

- 1 Make sure that the systems meet the installation requirements.

- 2 Complete the preparatory steps before starting the installation.  
For instructions, see the chapter "Preparing to install SF Oracle RAC" in this document.
- 3 Create a response file using one of the available options.  
For information on various options available for creating a response file:  
See ["About response files"](#) on page 353.

---

**Note:** You must replace the host names in the response file with that of the new systems in the cluster.

---

For guidelines on creating a response file:

See ["Guidelines for creating the SF Oracle RAC response file"](#) on page 356.

For a sample response file:

See ["Sample response file for installing SF Oracle RAC"](#) on page 376.

See ["Sample response file for configuring SF Oracle RAC"](#) on page 376.

- 4 Mount the product disc and navigate to the product directory that contains the installation program.
- 5 Start the installation:

```
./installsfrac -responsefile /tmp/response_file
```

Where `/tmp/response_file` is the full path name of the response file.

- 6 Restart the nodes after installation. Some of the depots require a restart operation before you can proceed to configure SF Oracle RAC.

---

**Note:** Do not use the reboot command to restart the nodes.

---

```
/usr/sbin/shutdown -r now
```

- 7 Start the configuration:

```
./installsfrac -responsefile /tmp/response_file
```

Where `/tmp/response_file` is the full path name of the response file.

---

**Note:** Fencing is configured in disabled mode. You need to configure fencing after the configuration.

---

8 Configure I/O fencing.

---

**Note:** Before you configure I/O fencing, make sure that you complete the required pre-configuration tasks. For instructions, see the chapter *Preparing to configure SF Oracle RAC* in this document.

---

For instructions on configuring I/O fencing using a response file, see the chapter *Configuring I/O fencing using a response file* in this document.

9 Complete the SF Oracle RAC post-installation tasks.

For instructions, see the chapter *Performing post-installation and configuration tasks* in this document.

## Response file variables to install Veritas Storage Foundation for Oracle RAC

Table 26-1 lists the response file variables that you can define to install SF Oracle RAC.

**Table 26-1** Response file variables for installing SF Oracle RAC

| Variable                                                                                     | Description                                                                                                                                                                                                                                                                                                                                                                                                                                                                                                                                                                                                                 |
|----------------------------------------------------------------------------------------------|-----------------------------------------------------------------------------------------------------------------------------------------------------------------------------------------------------------------------------------------------------------------------------------------------------------------------------------------------------------------------------------------------------------------------------------------------------------------------------------------------------------------------------------------------------------------------------------------------------------------------------|
| CFG{opt}{install}                                                                            | <p>Installs SF Oracle RAC depots. Configuration can be performed at a later time using the <code>-configure</code> option.</p> <p>List or scalar: scalar</p> <p>Optional or required: optional</p>                                                                                                                                                                                                                                                                                                                                                                                                                          |
| CFG{opt}{installallpkgs}<br>or<br>CFG{opt}{installrecpkgs}<br>or<br>CFG{opt}{installminpkgs} | <p>Instructs the installer to install SF Oracle RAC depots based on the variable that has the value set to 1:</p> <ul style="list-style-type: none"> <li>■ <code>installallpkgs</code>: Installs all depots</li> <li>■ <code>installrecpkgs</code>: Installs recommended depots</li> <li>■ <code>installminpkgs</code>: Installs minimum depots</li> </ul> <p><b>Note:</b> Set only one of these variable values to 1. In addition to setting the value of one of these variables, you must set the variable <code>\$CFG{opt}{install}</code> to 1.</p> <p>List or scalar: scalar</p> <p>Optional or required: required</p> |

**Table 26-1** Response file variables for installing SF Oracle RAC (*continued*)

| Variable            | Description                                                                                                                                                                                                     |
|---------------------|-----------------------------------------------------------------------------------------------------------------------------------------------------------------------------------------------------------------|
| CFG{accepteula}     | Specifies whether you agree with the EULA.pdf file on the media.<br><br>List or scalar: scalar<br>Optional or required: required                                                                                |
| CFG{opt}{vxkeyless} | Installs the product with keyless license.<br><br>List or scalar: scalar<br>Optional or required: optional                                                                                                      |
| CFG{opt}{license}   | Installs the product with permanent license.<br><br>List or scalar: scalar<br>Optional or required: optional                                                                                                    |
| CFG{keys}{hostname} | List of keys to be registered on the system if the variable CFG{opt}{vxkeyless} is set to 0 or if the variable \$CFG{opt}{licence} is set to 1.<br><br>List or scalar: scalar<br>Optional or required: optional |
| CFG{systems}        | List of systems on which the product is to be installed or uninstalled.<br><br>List or scalar: list<br>Optional or required: required                                                                           |
| CFG{prod}           | Defines the product to be installed or uninstalled.<br><br>List or scalar: scalar<br>Optional or required: required                                                                                             |
| CFG{opt}{keyfile}   | Defines the location of an ssh keyfile that is used to communicate with all remote systems.<br><br>List or scalar: scalar<br>Optional or required: optional                                                     |

**Table 26-1** Response file variables for installing SF Oracle RAC (*continued*)

| Variable           | Description                                                                                                                                                                                                                                        |
|--------------------|----------------------------------------------------------------------------------------------------------------------------------------------------------------------------------------------------------------------------------------------------|
| CFG{opt}{pkgpath}  | <p>Defines a location, typically an NFS mount, from which all remote systems can install product depots. The location must be accessible from all target systems.</p> <p>List or scalar: scalar</p> <p>Optional or required: optional</p>          |
| CFG{opt}{tmppath}  | <p>Defines the location where a working directory is created to store temporary files and the depots that are needed during the install. The default location is /var/tmp.</p> <p>List or scalar: scalar</p> <p>Optional or required: optional</p> |
| CFG{opt}{rsh}      | <p>Defines that <i>rsh</i> must be used instead of <i>ssh</i> as the communication method between systems.</p> <p>List or scalar: scalar</p> <p>Optional or required: optional</p>                                                                 |
| CFG{opt}{logpath}  | <p>Mentions the location where the log files are to be copied. The default location is /opt/VRTS/install/logs.</p> <p>List or scalar: scalar</p> <p>Optional or required: optional</p>                                                             |
| CFG{opt}{prodmode} | <p>List of modes for product</p> <p>List or scalar: list</p> <p>Optional or required: optional</p>                                                                                                                                                 |

## Response file variables to configure Veritas Storage Foundation for Oracle RAC

[Table 26-2](#) lists the response file variables that you can define to configure SF Oracle RAC.

**Table 26-2** Response file variables specific to configuring Veritas Storage Foundation for Oracle RAC

| Variable                          | List or Scalar | Description                                                                                                                                                         |
|-----------------------------------|----------------|---------------------------------------------------------------------------------------------------------------------------------------------------------------------|
| \$CFG{config_cfs}                 | Scalar         | Performs the Cluster File System configuration for SF Oracle RAC.<br><br>(Required)<br><br>Set the value to 1 to configure Cluster File System for SF Oracle RAC.   |
| CFG{opt}{configure}               | Scalar         | Performs the configuration if the depots are already installed.<br><br>(Required)<br><br>Set the value to 1 to configure SF Oracle RAC.                             |
| \$CFG{config_sfrac_subcomponents} | Scalar         | Set the variable to 1 to configure the SF Oracle RAC components.<br><br>(Required)<br><br><b>Note:</b> You must set the <i>\$CFG{opt}{configure}</i> variable to 1. |
| CFG{accepteula}                   | Scalar         | Specifies whether you agree with EULA.pdf on the media.<br><br>(Required)                                                                                           |
| CFG{systems}                      | List           | List of systems on which the product is to be configured.<br><br>(Required)                                                                                         |
| CFG{prod}                         | Scalar         | Defines the product to be configured.<br><br>The value is VCS60 for VCS.<br><br>(Required)                                                                          |
| CFG{opt}{keyfile}                 | Scalar         | Defines the location of an ssh keyfile that is used to communicate with all remote systems.<br><br>(Optional)                                                       |

**Table 26-2** Response file variables specific to configuring Veritas Storage Foundation for Oracle RAC (*continued*)

| Variable          | List or Scalar | Description                                                                                                                                                                                                                                                        |
|-------------------|----------------|--------------------------------------------------------------------------------------------------------------------------------------------------------------------------------------------------------------------------------------------------------------------|
| CFG{opt}{rsh}     | Scalar         | Defines that <i>remsh</i> must be used instead of <i>ssh</i> as the communication method between systems.<br><br>(Optional)                                                                                                                                        |
| CFG{opt}{logpath} | Scalar         | Mentions the location where the log files are to be copied. The default location is <i>/opt/VRTS/install/logs</i> .<br><br><b>Note:</b> The installer copies the response files and summary files also to the specified <i>logpath</i> location.<br><br>(Optional) |
| CFG{uploadlogs}   | Scalar         | Defines a Boolean value 0 or 1.<br><br>The value 1 indicates that the installation logs are uploaded to the Symantec Web site.<br><br>The value 0 indicates that the installation logs are not uploaded to the Symantec Web site.<br><br>(Optional)                |

Note that some optional variables make it necessary to define other optional variables. For example, all the variables that are related to the cluster service group (*csgnic*, *csgvip*, and *csgnetmask*) must be defined if any are defined. The same is true for the SMTP notification (*smtpserver*, *smtprecp*, and *smtpsev*), the SNMP trap notification (*snmpport*, *snmpcons*, and *snmpcsev*), and the Global Cluster Option (*gconic*, *gcovip*, and *gconetmask*).

[Table 26-3](#) lists the response file variables that specify the required information to configure a basic SF Oracle RAC cluster.



**Table 26-3** Response file variables specific to configuring a basic SF Oracle RAC cluster

| Variable             | List or Scalar | Description                                                                                                                                        |
|----------------------|----------------|----------------------------------------------------------------------------------------------------------------------------------------------------|
| CFG{vcs_clusterid}   | Scalar         | An integer between 0 and 65535 that uniquely identifies the cluster.<br>(Required)                                                                 |
| CFG{vcs_clustername} | Scalar         | Defines the name of the cluster.<br>(Required)                                                                                                     |
| CFG{vcs_allowcomms}  | Scalar         | Indicates whether or not to start LLT and GAB when you set up a single-node cluster. The value can be 0 (do not start) or 1 (start).<br>(Required) |

[Table 26-4](#) lists the response file variables that specify the required information to configure LLT over Ethernet.

**Table 26-4** Response file variables specific to configuring private LLT over Ethernet

| Variable                        | List or Scalar | Description                                                                                                                                                                                                                                                |
|---------------------------------|----------------|------------------------------------------------------------------------------------------------------------------------------------------------------------------------------------------------------------------------------------------------------------|
| CFG{vcs_lltlink#}<br>{"system"} | Scalar         | Defines the NIC to be used for a private heartbeat link on each system. Two LLT links are required per system (lltlink1 and lltlink2). You can configure up to four LLT links.<br><br>You must enclose the system name within double quotes.<br>(Required) |

**Table 26-4** Response file variables specific to configuring private LLT over Ethernet (*continued*)

| Variable                              | List or Scalar | Description                                                                                                                                                                                                                                                                                                                                                                                                                                                   |
|---------------------------------------|----------------|---------------------------------------------------------------------------------------------------------------------------------------------------------------------------------------------------------------------------------------------------------------------------------------------------------------------------------------------------------------------------------------------------------------------------------------------------------------|
| CFG{vcs_lltlinklowpri#}<br>{"system"} | Scalar         | <p>Defines a low priority heartbeat link. Typically, lltlinklowpri is used on a public network link to provide an additional layer of communication.</p> <p>If you use different media speed for the private NICs, you can configure the NICs with lesser speed as low-priority links to enhance LLT performance. For example, lltlinklowpri1, lltlinklowpri2, and so on.</p> <p>You must enclose the system name within double quotes.</p> <p>(Optional)</p> |

[Table 26-5](#) lists the response file variables that specify the required information to configure LLT over UDP.

**Table 26-5** Response file variables specific to configuring LLT over UDP

| Variable                                   | List or Scalar | Description                                                                                                                                                                                                                                     |
|--------------------------------------------|----------------|-------------------------------------------------------------------------------------------------------------------------------------------------------------------------------------------------------------------------------------------------|
| CFG{lltoverudp}=1                          | Scalar         | <p>Indicates whether to configure heartbeat link using LLT over UDP.</p> <p>(Required)</p>                                                                                                                                                      |
| CFG{vcs_udplink<n>_address}<br>{<system1>} | Scalar         | <p>Stores the IP address (IPv4 ) that the heartbeat link uses on node1.</p> <p>You can have four heartbeat links and &lt;n&gt; for this response file variable can take values 1 to 4 for the respective heartbeat links.</p> <p>(Required)</p> |

**Table 26-5** Response file variables specific to configuring LLT over UDP  
*(continued)*

| Variable                                             | List or Scalar | Description                                                                                                                                                                                                                                                                            |
|------------------------------------------------------|----------------|----------------------------------------------------------------------------------------------------------------------------------------------------------------------------------------------------------------------------------------------------------------------------------------|
| CFG<br>{vcs_udplinklowpri<n>_address}<br>{<system1>} | Scalar         | Stores the IP address (IPv4) that the low priority heartbeat link uses on node1.<br><br>You can have four low priority heartbeat links and <n> for this response file variable can take values 1 to 4 for the respective low priority heartbeat links.<br><br>(Required)               |
| CFG{vcs_udplink<n>_port}<br>{<system1>}              | Scalar         | Stores the UDP port (16-bit integer value) that the heartbeat link uses on node1.<br><br>You can have four heartbeat links and <n> for this response file variable can take values 1 to 4 for the respective heartbeat links.<br><br>(Required)                                        |
| CFG{vcs_udplinklowpri<n>_port}<br>{<system1>}        | Scalar         | Stores the UDP port (16-bit integer value) that the low priority heartbeat link uses on node1.<br><br>You can have four low priority heartbeat links and <n> for this response file variable can take values 1 to 4 for the respective low priority heartbeat links.<br><br>(Required) |
| CFG{vcs_udplink<n>_netmask}<br>{<system1>}           | Scalar         | Stores the netmask that the heartbeat link uses on node1.<br><br>You can have four heartbeat links and <n> for this response file variable can take values 1 to 4 for the respective heartbeat links.<br><br>(Required)                                                                |

**Table 26-5** Response file variables specific to configuring LLT over UDP  
*(continued)*

| Variable                                         | List or Scalar | Description                                                                                                                                                                                                                                                    |
|--------------------------------------------------|----------------|----------------------------------------------------------------------------------------------------------------------------------------------------------------------------------------------------------------------------------------------------------------|
| CFG{vcs_udplinklowpri<n>_netmask}<br>{<system1>} | Scalar         | Stores the netmask that the low priority heartbeat link uses on node1.<br><br>You can have four low priority heartbeat links and <n> for this response file variable can take values 1 to 4 for the respective low priority heartbeat links.<br><br>(Required) |

[Table 26-6](#) lists the response file variables that specify the required information to configure virtual IP for SF Oracle RAC cluster.

**Table 26-6** Response file variables specific to configuring virtual IP for SF Oracle RAC cluster

| Variable                    | List or Scalar | Description                                                                                                                                |
|-----------------------------|----------------|--------------------------------------------------------------------------------------------------------------------------------------------|
| CFG{vcs_csgnic}<br>{system} | Scalar         | Defines the NIC device to use on a system. You can enter 'all' as a system value if the same NIC is used on all systems.<br><br>(Optional) |
| CFG{vcs_csgvip}             | Scalar         | Defines the virtual IP address for the cluster.<br><br>(Optional)                                                                          |
| CFG{vcs_csgnetmask}         | Scalar         | Defines the Netmask of the virtual IP address for the cluster.<br><br>(Optional)                                                           |

[Table 26-7](#) lists the response file variables that specify the required information to configure the SF Oracle RAC cluster in secure mode.

**Table 26-7** Response file variables specific to configuring SF Oracle RAC cluster in secure mode

| Variable                   | List or Scalar | Description                                                                                                                                                                                             |
|----------------------------|----------------|---------------------------------------------------------------------------------------------------------------------------------------------------------------------------------------------------------|
| CFG{vcs_eat_security}      | Scalar         | Specifies if the cluster is in secure enabled mode or not.                                                                                                                                              |
| CFG{opt}{securityonenode}  | Scalar         | Specifies that the securityonenode option is being used.                                                                                                                                                |
| CFG{securityonenode_menu}  | Scalar         | Specifies the menu option to choose to configure the secure cluster one at a time. <ul style="list-style-type: none"> <li>■ 1—Configure the first node</li> <li>■ 2—Configure the other node</li> </ul> |
| CFG{security_conf_dir}     | Scalar         | Specifies the directory where the configuration files are placed.                                                                                                                                       |
| CFG{opt}{security}         | Scalar         | Specifies that the security option is being used.                                                                                                                                                       |
| CFG{opt}{fips}             | Scalar         | Specifies that the FIPS option is being used.                                                                                                                                                           |
| CFG{vcs_eat_security_fips} | Scalar         | Specifies that the enabled security is FIPS compliant.                                                                                                                                                  |

Table 26-8 lists the response file variables that specify the required information to configure VCS users.

**Table 26-8** Response file variables specific to configuring VCS users

| Variable          | List or Scalar | Description                                                                                                                                                                                                                                                        |
|-------------------|----------------|--------------------------------------------------------------------------------------------------------------------------------------------------------------------------------------------------------------------------------------------------------------------|
| CFG{vcs_userenpw} | List           | List of encoded passwords for VCS users<br><br>The value in the list can be "Administrators Operators Guests"<br><br><b>Note:</b> The order of the values for the vcs_userenpw list must match the order of the values in the vcs_username list.<br><br>(Optional) |

**Table 26-8** Response file variables specific to configuring VCS users (*continued*)

| Variable          | List or Scalar | Description                                                                                                                                                                           |
|-------------------|----------------|---------------------------------------------------------------------------------------------------------------------------------------------------------------------------------------|
| CFG{vcs_username} | List           | List of names of VCS users<br><br>(Optional)                                                                                                                                          |
| CFG{vcs_userpriv} | List           | List of privileges for VCS users<br><br><b>Note:</b> The order of the values for the vcs_userpriv list must match the order of the values in the vcs_username list.<br><br>(Optional) |

[Table 26-9](#) lists the response file variables that specify the required information to configure VCS notifications using SMTP.

**Table 26-9** Response file variables specific to configuring VCS notifications using SMTP

| Variable            | List or Scalar | Description                                                                                                                                                                                                                                            |
|---------------------|----------------|--------------------------------------------------------------------------------------------------------------------------------------------------------------------------------------------------------------------------------------------------------|
| CFG{vcs_smtpserver} | Scalar         | Defines the domain-based hostname (example: smtp.symantecexample.com) of the SMTP server to be used for Web notification.<br><br>(Optional)                                                                                                            |
| CFG{vcs_smtprecp}   | List           | List of full email addresses (example: user@symantecexample.com) of SMTP recipients.<br><br>(Optional)                                                                                                                                                 |
| CFG{vcs_smtpsev}    | List           | Defines the minimum severity level of messages (Information, Warning, Error, SevereError) that listed SMTP recipients are to receive. Note that the ordering of severity levels must match that of the addresses of SMTP recipients.<br><br>(Optional) |

[Table 26-10](#) lists the response file variables that specify the required information to configure VCS notifications using SNMP.

**Table 26-10** Response file variables specific to configuring VCS notifications using SNMP

| Variable          | List or Scalar | Description                                                                                                                                                                                                                                       |
|-------------------|----------------|---------------------------------------------------------------------------------------------------------------------------------------------------------------------------------------------------------------------------------------------------|
| CFG{vcs_snmpport} | Scalar         | Defines the SNMP trap daemon port (default=162).<br><br>(Optional)                                                                                                                                                                                |
| CFG{vcs_snmpcons} | List           | List of SNMP console system names<br><br>(Optional)                                                                                                                                                                                               |
| CFG{vcs_snmpcsev} | List           | Defines the minimum severity level of messages (Information, Warning, Error, SevereError) that listed SNMP consoles are to receive. Note that the ordering of severity levels must match that of the SNMP console system names.<br><br>(Optional) |

[Table 26-11](#) lists the response file variables that specify the required information to configure SF Oracle RAC global clusters.

**Table 26-11** Response file variables specific to configuring SF Oracle RAC global clusters

| Variable                    | List or Scalar | Description                                                                                                                                                             |
|-----------------------------|----------------|-------------------------------------------------------------------------------------------------------------------------------------------------------------------------|
| CFG{vcs_gconic}<br>{system} | Scalar         | Defines the NIC for the Virtual IP that the Global Cluster Option uses. You can enter 'all' as a system value if the same NIC is used on all systems.<br><br>(Optional) |
| CFG{vcs_gcovip}             | Scalar         | Defines the virtual IP address to that the Global Cluster Option uses.<br><br>(Optional)                                                                                |

**Table 26-11** Response file variables specific to configuring SF Oracle RAC global clusters (*continued*)

| Variable            | List or Scalar | Description                                                                                          |
|---------------------|----------------|------------------------------------------------------------------------------------------------------|
| CFG{vcs_gconetmask} | Scalar         | Defines the Netmask of the virtual IP address that the Global Cluster Option uses.<br><br>(Optional) |

## Sample response file for installing SF Oracle RAC

The following sample response file installs SF Oracle RAC on two nodes, `sys1` and `sys2`.

```
our %CFG;

$CFG{accepteula}=1;
$CFG{opt}{vxkeyless}=1;
$CFG{opt}{install}=1;
$CFG{opt}{installallpkgs}=1;
$CFG{prod}="SFRAC60";
$CFG{systems}=[qw(sys1 sys2)];
$CFG{uploadlogs}=0;

1;
```

## Sample response file for configuring SF Oracle RAC

The following sample response file configures SF Oracle RAC on two nodes, `sys1` and `sys2`.

```
our %CFG;

$CFG{accepteula}=1;
$CFG{opt}{install}=1;
$CFG{prod}="SFRAC60";
$CFG{systems}=[qw(sys1 sys2)];
$CFG{opt}{configure}=1;
$CFG{config_sfrac_subcomponents} = 1;
$CFG{vcs_allowcomms}=1;
$CFG{vcs_clusterid}=101;
$CFG{vcs_clustername}="clus1";
```



```
$CFG{vcs_11tlink1}{sys1}="lan1";
$CFG{vcs_11tlink1}{sys2}="lan1";
$CFG{vcs_11tlink2}{sys1}="lan2";
$CFG{vcs_11tlink2}{sys2}="lan2";
$CFG{vcs_username}=[qw(admin)];
$CFG{vcs_userpriv}=[qw(Administrators)];
$CFG{vcs_userenpw}=[qw(gpqIpkPmqLqqOyqKpn)];
$CFG{uploadlogs}=0;

1;
```

# Performing an automated I/O fencing configuration using response files

This chapter includes the following topics:

- [Configuring I/O fencing using response files](#)
- [Response file variables to configure disk-based I/O fencing](#)
- [Sample response file for configuring disk-based I/O fencing](#)
- [Configuring CP server using response files](#)
- [Response file variables to configure CP server](#)
- [Sample response file for configuring the CP server on SFHA cluster](#)
- [Response file variables to configure server-based I/O fencing](#)
- [Sample response file for configuring server-based I/O fencing](#)

## Configuring I/O fencing using response files

Typically, you can use the response file that the installer generates after you perform I/O fencing configuration to configure I/O fencing for SF Oracle RAC.

**To configure I/O fencing using response files**

- 1 Make sure that SF Oracle RAC is configured.
- 2 Based on whether you want to configure disk-based or server-based I/O fencing, make sure you have completed the preparatory tasks.  
 See [“About planning to configure I/O fencing”](#) on page 58.
- 3 Copy the response file to one of the cluster systems where you want to configure I/O fencing.  
 See [“Sample response file for configuring disk-based I/O fencing”](#) on page 382.  
 See [“Sample response file for configuring server-based I/O fencing”](#) on page 387.
- 4 Edit the values of the response file variables as necessary.  
 See [“Response file variables to configure disk-based I/O fencing”](#) on page 379.  
 See [“Response file variables to configure server-based I/O fencing”](#) on page 386.
- 5 Start the configuration from the system to which you copied the response file. For example:

```
/opt/VRTS/install/installsfrac<version>
-responsefile /tmp/response_file
```

Where *<version>* is the specific release version, and */tmp/response\_file* is the response file’s full path name.

See [“About the Veritas installer”](#) on page 77.

# Response file variables to configure disk-based I/O fencing

[Table 27-1](#) lists the response file variables that specify the required information to configure disk-based I/O fencing for SF Oracle RAC.

**Table 27-1** Response file variables specific to configuring disk-based I/O fencing

| Variable          | List or Scalar | Description                                           |
|-------------------|----------------|-------------------------------------------------------|
| CFG{opt}{fencing} | Scalar         | Performs the I/O fencing configuration.<br>(Required) |

**Table 27-1** Response file variables specific to configuring disk-based I/O fencing  
*(continued)*

| Variable                        | List or Scalar | Description                                                                                                                                                                                                                                                                                                                                             |
|---------------------------------|----------------|---------------------------------------------------------------------------------------------------------------------------------------------------------------------------------------------------------------------------------------------------------------------------------------------------------------------------------------------------------|
| CFG{fencing_option}             | Scalar         | <p>Specifies the I/O fencing configuration mode.</p> <ul style="list-style-type: none"> <li>■ 1—Coordination Point Server-based I/O fencing</li> <li>■ 2—Coordinator disk-based I/O fencing</li> <li>■ 3—Disabled mode</li> <li>■ 4—Fencing migration when the cluster is online</li> </ul> <p>(Required)</p>                                           |
| CFG {fencing_scsi3_disk_policy} | Scalar         | <p>Specifies the I/O fencing mechanism.</p> <p>This variable is not required if you had configured fencing in disabled mode. For disk-based fencing, you must configure the <code>fencing_scsi3_disk_policy</code> variable and either the <code>fencing_dgname</code> variable or the <code>fencing_newdg_disks</code> variable.</p> <p>(Optional)</p> |
| CFG{fencing_dgname}             | Scalar         | <p>Specifies the disk group for I/O fencing.</p> <p>(Optional)</p> <p><b>Note:</b> You must define the <code>fencing_dgname</code> variable to use an existing disk group. If you want to create a new disk group, you must use both the <code>fencing_dgname</code> variable and the <code>fencing_newdg_disks</code> variable.</p>                    |

**Table 27-1** Response file variables specific to configuring disk-based I/O fencing  
*(continued)*

| Variable                          | List or Scalar | Description                                                                                                                                                                                                                                                                                                                                                                                                                                                                                                                                                                                                                                                                                                                                                                              |
|-----------------------------------|----------------|------------------------------------------------------------------------------------------------------------------------------------------------------------------------------------------------------------------------------------------------------------------------------------------------------------------------------------------------------------------------------------------------------------------------------------------------------------------------------------------------------------------------------------------------------------------------------------------------------------------------------------------------------------------------------------------------------------------------------------------------------------------------------------------|
| CFG{fencing_newdg_disks}          | List           | <p>Specifies the disks to use to create a new disk group for I/O fencing.</p> <p>(Optional)</p> <p><b>Note:</b> You must define the <code>fencing_dgname</code> variable to use an existing disk group. If you want to create a new disk group, you must use both the <code>fencing_dgname</code> variable and the <code>fencing_newdg_disks</code> variable.</p>                                                                                                                                                                                                                                                                                                                                                                                                                        |
| CFG{fencing_cpagent_monitor_freq} | Scalar         | <p>Specifies the frequency at which the Coordination Point Agent monitors for any changes to the Coordinator Disk Group constitution.</p> <p><b>Note:</b> Coordination Point Agent can also monitor changes to the Coordinator Disk Group constitution such as a disk being accidentally deleted from the Coordinator Disk Group. The frequency of this detailed monitoring can be tuned with the <code>LevelTwoMonitorFreq</code> attribute. For example, if you set this attribute to 5, the agent will monitor the Coordinator Disk Group constitution every five monitor cycles. If <code>LevelTwoMonitorFreq</code> attribute is not set, the agent will not monitor any changes to the Coordinator Disk Group. 0 means not to monitor the Coordinator Disk Group constitution.</p> |
| CFG {fencing_config_cpagent}      | Scalar         | <p>Enter '1' or '0' depending upon whether you want to configure the Coordination Point agent using the installer or not.</p> <p>Enter "0" if you do not want to configure the Coordination Point agent using the installer.</p> <p>Enter "1" if you want to use the installer to configure the Coordination Point agent.</p>                                                                                                                                                                                                                                                                                                                                                                                                                                                            |

**Table 27-1** Response file variables specific to configuring disk-based I/O fencing  
*(continued)*

| Variable                 | List or Scalar | Description                                                                                                                                                                                                   |
|--------------------------|----------------|---------------------------------------------------------------------------------------------------------------------------------------------------------------------------------------------------------------|
| CFG {fencing_cpagentgrp} | Scalar         | Name of the service group which will have the Coordination Point agent resource as part of it.<br><br><b>Note:</b> This field is obsolete if the <b>fencing_config_cpagent</b> field is given a value of '0'. |

## Sample response file for configuring disk-based I/O fencing

Review the disk-based I/O fencing response file variables and their definitions.

See [“Response file variables to configure disk-based I/O fencing”](#) on page 379.

```
#
Configuration Values:
#
our %CFG;

$CFG{fencing_config_cpagent}=1;
$CFG{fencing_cpagent_monitor_freq}=5;
$CFG{fencing_cpagentgrp}="vxfen";
$CFG{fencing_dgname}="fencingdg1";
$CFG{fencing_newdg_disks}=[qw(emc_clariion0_155
 emc_clariion0_162 emc_clariion0_163)];
$CFG{fencing_option}=2;
$CFG{fencing_scsi3_disk_policy}="dmp";
$CFG{opt}{configure}=1;
$CFG{opt}{fencing}=1;

$CFG{prod}="SFRAC60";

$CFG{systems}=[qw(pilot25)];
$CFG{vcs_clusterid}=32283;
$CFG{vcs_clustername}="whf";
1;
```

## Configuring CP server using response files

You can configure a CP server using a generated responsefile.

**On a single node VCS cluster:**

- ◆ Run the `installvcs<version>` command with the `responsefile` option to configure the CP server on a single node VCS cluster.

```
/opt/VRTS/install/installvcs<version> \
-responsefile '/tmp/sample1.res'
```

Where `<version>` is the specific release version.

See [“About the Veritas installer”](#) on page 77.

**On a SFHA cluster:**

- ◆ Run the `installsfha<version>` command with the `responsefile` option to configure the CP server on a SFHA cluster.

```
/opt/VRTS/install/installsfha<version> \
-responsefile '/tmp/sample1.res'
```

Where `<version>` is the specific release version.

See [“About the Veritas installer”](#) on page 77.

## Response file variables to configure CP server

[Table 27-2](#) shows the response file variables required to configure CP server.

**Table 27-2** describes response file variables to configure CP server

| Variable                   | List or Scalar | Description                                                                             |
|----------------------------|----------------|-----------------------------------------------------------------------------------------|
| CFG{opt}{configcps}        | Scalar         | This variable performs CP server configuration task                                     |
| CFG{cps_singlenode_config} | Scalar         | This variable describes if the CP server will be configured on a singlenode VCS cluster |
| CFG{cps_sfha_config}       | Scalar         | This variable describes if the CP server will be configured on a SFHA cluster           |

**Table 27-2** describes response file variables to configure CP server (*continued*)

| Variable                          | List or Scalar | Description                                                                                        |
|-----------------------------------|----------------|----------------------------------------------------------------------------------------------------|
| CFG{cps_unconfig}                 | Scalar         | This variable describes if the CP server will be unconfigured                                      |
| CFG{cpsname}                      | Scalar         | This variable describes the name of the CP server                                                  |
| CFG{cps_db_dir}                   | Scalar         | This variable describes the absolute path of CP server database                                    |
| CFG{cps_security}                 | Scalar         | This variable describes if security is configured for the CP server                                |
| CFG{cps_reuse_cred}               | Scalar         | This variable describes if reusing the existing credentials for the CP server                      |
| CFG{cps_vips}                     | List           | This variable describes the virtual IP addresses for the CP server                                 |
| CFG{cps_ports}                    | List           | This variable describes the port number for the virtual IP addresses for the CP server             |
| CFG{cps_nic_list}{cpsvip<n>}      | List           | This variable describes the NICs of the systems for the virtual IP address                         |
| CFG{cps_netmasks}                 | List           | This variable describes the netmasks for the virtual IP addresses                                  |
| CFG{cps_prefix_length}            | List           | This variable describes the prefix length for the virtual IP addresses                             |
| CFG{cps_network_hosts}{cpsnic<n>} | List           | This variable describes the network hosts for the NIC resource                                     |
| CFG{cps_vip2nicres_map}{<vip>}    | Scalar         | This variable describes the NIC resource to associate with the virtual IP address                  |
| CFG{cps_diskgroup}                | Scalar         | This variable describes the disk group for the CP server database                                  |
| CFG{cps_volume}                   | Scalar         | This variable describes the volume for the CP server database                                      |
| CFG{cps_newdgd_disks}             | List           | This variable describes the disks to be used to create a new disk group for the CP server database |



**Table 27-2** describes response file variables to configure CP server (*continued*)

| Variable                   | List or Scalar | Description                                                                                                    |
|----------------------------|----------------|----------------------------------------------------------------------------------------------------------------|
| CFG{cps_newvol_volsize}    | Scalar         | This variable describes the volume size to create a new volume for the CP server database                      |
| CFG{cps_delete_database}   | Scalar         | This variable describes if deleting the database of the CP server during the unconfiguration                   |
| CFG{cps_delete_config_log} | Scalar         | This variable describes if deleting the config files and log files of the CP server during the unconfiguration |

## Sample response file for configuring the CP server on SFHA cluster

Review the response file variables and their definitions.

See [Table 27-2](#) on page 383.

```
#
Configuration Values:
#
our %CFG;

$CFG{cps_db_dir}="/cpsdb";
$CFG{cps_diskgroup}="mycpsdg";
$CFG{cps_netmasks}=[qw(255.255.252.0 255.255.252.0)];
$CFG{cps_network_hosts}{cpsnic1}=[qw(10.200.56.22)];
$CFG{cps_network_hosts}{cpsnic2}=[qw(10.200.56.22)];
$CFG{cps_nic_list}{cpsvip1}=[qw(lan0 lan1)];
$CFG{cps_nic_list}{cpsvip2}=[qw(lan0 lan1)];
$CFG{cps_ports}=[qw(65533 14250)];
$CFG{cps_security}=1;
$CFG{cps_fips_mode}=0;
$CFG{cps_sfha_config}=1;
$CFG{cps_vip2nicres_map}{"10.200.58.231"}=1;
$CFG{cps_vip2nicres_map}{"10.200.58.232"}=2;
$CFG{cps_vips}=[qw(10.200.58.231 10.200.58.232)];
```

```
$CFG{cps_volume}="mycpsvol";
$CFG{cpsname}="cps1";
$CFG{opt}{configcps}=1;
$CFG{opt}{configure}=1;
$CFG{prod}="SFHA601";
$CFG{systems}=[qw(cps1 cps2)];
$CFG{vcs_clusterid}=46707;
$CFG{vcs_clustername}="sfha2233";

1;
```

## Response file variables to configure server-based I/O fencing

You can use a coordination point server-based fencing response file to configure server-based customized I/O fencing.

[Table 27-3](#) lists the fields in the response file that are relevant for server-based customized I/O fencing.

**Table 27-3** Coordination point server (CP server) based fencing response file definitions

| Response file field          | Definition                                                                                                                                                                                                                                                                                                                    |
|------------------------------|-------------------------------------------------------------------------------------------------------------------------------------------------------------------------------------------------------------------------------------------------------------------------------------------------------------------------------|
| CFG {fencing_config_cpagent} | <p>Enter '1' or '0' depending upon whether you want to configure the Coordination Point agent using the installer or not.</p> <p>Enter "0" if you do not want to configure the Coordination Point agent using the installer.</p> <p>Enter "1" if you want to use the installer to configure the Coordination Point agent.</p> |
| CFG {fencing_cpagentgrp}     | <p>Name of the service group which will have the Coordination Point agent resource as part of it.</p> <p><b>Note:</b> This field is obsolete if the <code>fencing_config_cpagent</code> field is given a value of '0'.</p>                                                                                                    |
| CFG {fencing_cps}            | <p>Virtual IP address or Virtual hostname of the CP servers.</p>                                                                                                                                                                                                                                                              |

**Table 27-3** Coordination point server (CP server) based fencing response file definitions (*continued*)

| Response file field             | Definition                                                                                                                                                                                                                                                                                                                                                                                                                                                                                                                          |
|---------------------------------|-------------------------------------------------------------------------------------------------------------------------------------------------------------------------------------------------------------------------------------------------------------------------------------------------------------------------------------------------------------------------------------------------------------------------------------------------------------------------------------------------------------------------------------|
| CFG {fencing_reusedg}           | <p>This response file field indicates whether to reuse an existing DG name for the fencing configuration in customized fencing (CP server and coordinator disks).</p> <p>Enter either a "1" or "0".</p> <p>Entering a "1" indicates reuse, and entering a "0" indicates do not reuse.</p> <p>When reusing an existing DG name for the mixed mode fencing configuration, you need to manually add a line of text, such as "\$CFG{fencing_reusedg}=0" or "\$CFG{fencing_reusedg}=1" before proceeding with a silent installation.</p> |
| CFG {fencing_dgname}            | <p>The name of the disk group to be used in the customized fencing, where at least one disk is being used.</p>                                                                                                                                                                                                                                                                                                                                                                                                                      |
| CFG {fencing_disks}             | <p>The disks being used as coordination points if any.</p>                                                                                                                                                                                                                                                                                                                                                                                                                                                                          |
| CFG {fencing_ncp}               | <p>Total number of coordination points being used, including both CP servers and disks.</p>                                                                                                                                                                                                                                                                                                                                                                                                                                         |
| CFG {fencing_ndisks}            | <p>The number of disks being used.</p>                                                                                                                                                                                                                                                                                                                                                                                                                                                                                              |
| CFG {fencing_cps_vips}          | <p>The virtual IP addresses or the fully qualified host names of the CP server.</p>                                                                                                                                                                                                                                                                                                                                                                                                                                                 |
| CFG {fencing_cps_ports}         | <p>The port that the virtual IP address or the fully qualified host name of the CP server listens on.</p>                                                                                                                                                                                                                                                                                                                                                                                                                           |
| CFG {fencing_scsi3_disk_policy} | <p>The disk policy that the customized fencing uses.</p> <p>The value for this field is either "raw" or "dmp"</p>                                                                                                                                                                                                                                                                                                                                                                                                                   |

## Sample response file for configuring server-based I/O fencing

The following is a sample response file used for server-based I/O fencing:

```
$CFG{fencing_config_cpagent}=0;
$CFG{fencing_cps}=[qw(10.200.117.145)];
$CFG{fencing_cps_vips}{"10.200.117.145"}=[qw(10.200.117.145)];
```

```
$CFG{fencing_dgname}="vxfencoorddg";
$CFG{fencing_disks}=[qw(emc_clariion0_37 emc_clariion0_13)];
$CFG{fencing_scsi3_disk_policy}="raw";
$CFG{fencing_ncp}=3;
$CFG{fencing_ndisks}=2;
$CFG{fencing_cps_ports}{"10.200.117.145"}=14250;
$CFG{fencing_reusedg}=1;
$CFG{opt}{configure}=1;
$CFG{opt}{fencing}=1;
$CFG{prod}="SFRAC60";
$CFG{systems}=[qw(sys1 sys2)];
$CFG{vcs_clusterid}=1256;
$CFG{vcs_clustername}="clus1";
$CFG{fencing_option}=1;
```

# Installing Oracle RAC using a response file

This chapter includes the following topics:

- [About installing Oracle RAC using response files](#)
- [Before you install](#)
- [Installing Oracle RAC](#)
- [Response file variable definitions for Oracle RAC](#)
- [Sample response file for installing Oracle RAC](#)

## About installing Oracle RAC using response files

You can perform a silent pre-configuration of your systems by running the SF Oracle RAC installer with the `-responsefile` option. This capability in tandem with the Oracle response files for Oracle Clusterware and Oracle database installation enables you to standardize and automate Oracle RAC deployments in your cluster.

## Before you install

Make sure that you complete the tasks in the following procedure before starting the silent installation of Oracle RAC.

**To prepare the systems for installing Oracle RAC using response files**

- 1 Make sure that the systems meet the installation requirements.  
For information on requirements, see the chapter *System requirements* in this document.
- 2 Complete the following preparatory tasks on the nodes manually or by using the SF Oracle RAC installer:
  - Identify the public virtual IP addresses for use by Oracle
  - Plan for the storage and the private network configuration for Oracle RAC
  - Set the kernel parameters
  - Verify the user "nobody" exists
  - Create Oracle user and groups
  - Set up Oracle user equivalence
  - Edit the Oracle user profile

For instructions, see the chapter *Before installing Oracle RAC* in this document.

- 3 Create response files for Oracle Clusterware/Grid Infrastructure and Oracle database installation using the response file template provided by Oracle RAC.  
For instructions on using the response file template, see the Oracle RAC documentation.

---

**Note:** Keep at hand the full path of the directory where these response files will be saved. The full path of the Oracle Clusterware/Grid Infrastructure response file must be set in the SF Oracle RAC response file variable `$CFG{crs_responsefile};`. The full path of the Oracle database response file must be set in the SF Oracle RAC response file variable `$CFG{db_responsefile};`.

---

- 4 Create an SF Oracle RAC response file.  
For information on various options available for creating a response file:  
See [“About response files”](#) on page 353.  
Make sure that you provide the full path information of the Oracle Clusterware/Grid Infrastructure and Oracle database response files.  
For guidelines on creating a response file:  
See [“Guidelines for creating the SF Oracle RAC response file”](#) on page 356.  
For information on the list of required and optional variables:  
See [“Response file variable definitions for Oracle RAC”](#) on page 392.  
For a sample response file:  
See [“Sample response file for installing Oracle RAC”](#) on page 409.
- 5 Make sure that the Oracle user has appropriate read and write permissions on the response files.
- 6 Make sure that passwordless communication between Oracle users is set up on the nodes of the cluster.

## Installing Oracle RAC

To perform a silent installation of Oracle RAC, run the SF Oracle RAC installer. The installer supports completion of the following tasks using the response file:

- Creates storage for OCR and voting disk
- Configures the private network for Oracle RAC
- Installs Oracle Clusterware/Grid Infrastructure by leveraging the corresponding Oracle response file
- Installs Oracle database by leveraging the Oracle database response file
- Relinks the Oracle RAC libraries with SF Oracle RAC libraries
- Configures the CSSD agent

The sample procedure assumes that Oracle user equivalence is established on all the nodes in the cluster.

**To perform Oracle pre-installation and installation on the nodes**

- 1 Navigate to the directory containing the SF Oracle RAC installer:

```
cd /opt/VRTS/install
```

- 2 Start the installation:

```
./installsfrac<version> -responsefile /tmp/response_file
```

Where <version> is the specific release version.

See [“About the Veritas installer”](#) on page 77.

Where /tmp/response\_file is the full path name of the SF Oracle RAC response file.

- 3 Run the root.sh script as the root user on the cluster nodes.

---

**Note:** Do not run the script simultaneously on your cluster nodes.

---

- 4 Complete the following Oracle post-installation tasks:

- Add any patches or patchsets required by Oracle RAC .
- Create the Oracle RAC database.
- Add the Oracle UDP IPC private IP addresses to the Oracle `init.ora` file if the database cache fusion traffic is configured to use Oracle UDP IPC private IP addresses and if these addresses are configured as a PrivNIC or MultiPrivNIC resource for high availability.
- Configure the Oracle RAC database for manual startup if you want the Oracle RAC database to be managed by VCS using the Oracle agent.
- Configure the VCS service groups for Oracle RAC.
- Verify the cluster.
- Remove the temporary communication permissions.

For instructions:

See the chapter *Performing Oracle RAC post-installation tasks*.

## Response file variable definitions for Oracle RAC

The variable definitions for Oracle RAC are grouped in tabular format for the following Oracle tasks:



|                                                                        |                                             |
|------------------------------------------------------------------------|---------------------------------------------|
| Creating Oracle user and group                                         | See <a href="#">Table 28-1</a> on page 393. |
| Creating storage for OCR and voting disk                               | See <a href="#">Table 28-2</a> on page 395. |
| Configuring the private IP address and PrivNIC resource under VCS      | See <a href="#">Table 28-3</a> on page 398. |
| Configuring the private IP address and MultiPrivNIC resource under VCS | See <a href="#">Table 28-4</a> on page 402. |
| Installing Oracle Clusterware                                          | See <a href="#">Table 28-5</a> on page 405. |
| Installing Oracle database                                             | See <a href="#">Table 28-6</a> on page 406. |
| Configuring CSSD resource                                              | See <a href="#">Table 28-7</a> on page 407. |
| Relinking Oracle RAC libraries                                         | See <a href="#">Table 28-8</a> on page 408. |

---

**Note:** Some of the variable definitions may occur in multiple sections, for example `$CFG{oracle_user}`. These variables need not be repeated if all the tasks are performed as a single installation activity. However, if you perform these tasks independently, make sure that all the required variables, as indicated in the table for each task, are supplied in the response file.

---

[Table 28-1](#) lists the variables that are used to create the Oracle user and group.

**Table 28-1** Variables for creating Oracle user and group

| Variable                                     | List or Scalar | Description                                                                                                                                                                               |
|----------------------------------------------|----------------|-------------------------------------------------------------------------------------------------------------------------------------------------------------------------------------------|
| <code>\$CFG{create_oracle_user_group}</code> | Scalar         | Required<br>Defines a Boolean value 0 or 1.<br>The value 1 indicates that Oracle user and group will be created.<br>The value 0 indicates that Oracle user and group will not be created. |
| <code>\$CFG{grid_user}</code>                | Scalar         | Required<br>Defines the name of the grid user.                                                                                                                                            |
| <code>\$CFG{oracle_user}</code>              | Scalar         | Required<br>Defines the name of the Oracle user.                                                                                                                                          |

**Table 28-1** Variables for creating Oracle user and group (*continued*)

| Variable                      | List or Scalar | Description                                                                                                                                                                                             |
|-------------------------------|----------------|---------------------------------------------------------------------------------------------------------------------------------------------------------------------------------------------------------|
| \$CFG{oracle_uid}             | Scalar         | Required<br>Defines the user ID of the Oracle user.                                                                                                                                                     |
| \$CFG{oracle_group}           | Scalar         | Required<br>Defines the primary group of the Oracle user.                                                                                                                                               |
| \$CFG{oracle_gid}             | Scalar         | Required<br>Defines the group ID of the Oracle user.                                                                                                                                                    |
| \$CFG{oracle_user_home}       | Scalar         | Required<br>Defines the full path of the Oracle user's home directory.                                                                                                                                  |
| \$CFG{oracle_secondary_group} | List           | Optional<br>Defines the list of secondary groups for the Oracle user.                                                                                                                                   |
| \$CFG{oracle_secondary_gid}   | List           | Optional<br>Defines the list of secondary group IDs for the Oracle user. The elements of this variable must be in the same order as that of the elements in the variable \$CFG{oracle_secondary_group}. |

[Table 28-2](#) lists the variables that are used to create the storage for OCR and voting disk.

**Table 28-2** Variables for creating storage for OCR and voting disk

| Variable                       | List or Scalar | Description                                                                                                                                                                                                                                                                                                                                                                                                                                                                                                                                                                                                                               |
|--------------------------------|----------------|-------------------------------------------------------------------------------------------------------------------------------------------------------------------------------------------------------------------------------------------------------------------------------------------------------------------------------------------------------------------------------------------------------------------------------------------------------------------------------------------------------------------------------------------------------------------------------------------------------------------------------------------|
| \$CFG{create_ocr_vote_storage} | Scalar         | <p>Required</p> <p>Defines a Boolean value 0 or 1.</p> <p>The value 1 indicates that the storage for OCR and voting disk will be created.</p> <p>The value 0 indicates that the storage for OCR and voting disk will not be created.</p>                                                                                                                                                                                                                                                                                                                                                                                                  |
| \$CFG{enable_mirroring}        | Scalar         | <p>Required</p> <p>Defines a Boolean value 0 or 1.</p> <p>The value 1 indicates that the storage for OCR and voting disk is mirrored. Provide two disks as input for the variable \$CFG{ocrvotedisks}.</p> <p>The value 0 indicates that the storage for OCR and voting disk is not mirrored.</p>                                                                                                                                                                                                                                                                                                                                         |
| \$CFG{ocrvotedgoption}         | Scalar         | <p>Required</p> <p>Defines a Boolean value 0 or 1.</p> <p>The value 1 indicates that an existing disk group will be used to create the storage for OCR and voting disk.</p> <p><b>Note:</b> If you choose to use an existing disk group, use the \$CFG{ocrvotedgname} variable to specify the name of an existing disk group that has a minimum of two disks (for mirroring).</p> <p>The value 0 indicates that a new disk group will be created for OCR and voting disk storage.</p> <p><b>Note:</b> If you choose to create a disk group, you must set the following variables:<br/> \$CFG{ocrvotedisks},<br/> \$CFG{ocrvotedgname}</p> |

**Table 28-2** Variables for creating storage for OCR and voting disk (*continued*)

| Variable                  | List or Scalar | Description                                                                                                                                                                                                                                                                                                                                                                                                                                                                                                                                                                                          |
|---------------------------|----------------|------------------------------------------------------------------------------------------------------------------------------------------------------------------------------------------------------------------------------------------------------------------------------------------------------------------------------------------------------------------------------------------------------------------------------------------------------------------------------------------------------------------------------------------------------------------------------------------------------|
| \$CFG{ocrvotescheme}      | Scalar         | <p>Required</p> <p>Defines the storage scheme to be used for OCR and voting disk.</p> <p>The value 1 indicates Clustered File System.</p> <p>The value 0 indicates CVM raw volumes.</p>                                                                                                                                                                                                                                                                                                                                                                                                              |
| \$CFG{enable_sep_filesys} | Scalar         | <p>Required</p> <p>Defines a Boolean value 0 or 1.</p> <p>The value 1 indicates that OCR and voting disk are located on separate file systems. Provide values for the following variables: \$CFG{ocrvolname}, \$CFG{ocrvolsize}, \$CFG{votevolname}, \$CFG{votevolsize}, \$CFG{ocrmount}, \$CFG{votemount}</p> <p>The value 0 indicates that OCR and voting disk are located on the same file system. Provide a single volume name using the variable \$CFG{ocrvotevolname}, a single mount point using the variable \$CFG{ocrvotemount}, and the size using the variable \$CFG{ocrvotevolsize}.</p> |
| \$CFG{ocrvotedisks}       | List           | <p>Required</p> <p>Defines the list of shared disks to be used for OCR and voting disk.</p>                                                                                                                                                                                                                                                                                                                                                                                                                                                                                                          |
| \$CFG{ocrvotedgname}      | Scalar         | <p>Required</p> <p>Defines the name of the disk group to be used for OCR and voting disk.</p>                                                                                                                                                                                                                                                                                                                                                                                                                                                                                                        |
| \$CFG{ocrvotevolname}     | Scalar         | <p>Required</p> <p>Defines the volume name for OCR and voting disk. This variable must be used only if you have set the storage scheme to 1 (Clustered File System).</p>                                                                                                                                                                                                                                                                                                                                                                                                                             |

**Table 28-2** Variables for creating storage for OCR and voting disk (*continued*)

| Variable             | List or Scalar | Description                                                                                                                                                                                                                                                      |
|----------------------|----------------|------------------------------------------------------------------------------------------------------------------------------------------------------------------------------------------------------------------------------------------------------------------|
| \$CFG{ocrvoteolsize} | Scalar         | <p>Required</p> <p>Defines the size of the OCR and voting disk volume. This variable must be used only if you have set the storage scheme to 1 (Clustered File System).</p>                                                                                      |
| \$CFG{ocrvotemount}  | Scalar         | <p>Required if you have chosen to locate OCR and voting disk on the same file system.</p> <p>Defines the full path to the CFS mount point. This variable must be used only if you have set the storage scheme to 1 (Clustered File System).</p>                  |
| \$CFG{ocrmount}      | Scalar         | <p>Required if you have chosen to locate OCR and voting disk on separate file systems.</p> <p>Defines the full path to the CFS mount point for OCR. This variable must be used only if you have set the storage scheme to 1 (Clustered File System).</p>         |
| \$CFG{votemount}     | Scalar         | <p>Required if you have chosen to locate OCR and voting disk on separate file systems.</p> <p>Defines the full path to the CFS mount point for voting disk. This variable must be used only if you have set the storage scheme to 1 (Clustered File System).</p> |
| \$CFG{ocrvolname}    | Scalar         | <p>Required</p> <p>Defines the volume name for OCR. This variable must be used only if you have set the storage scheme to 0 (CVM Raw Volumes).</p>                                                                                                               |
| \$CFG{ocrvolsize}    | Scalar         | <p>Required</p> <p>Defines the size of the OCR volume. This variable must be used only if you have set the storage scheme to 0 (CVM Raw Volumes).</p>                                                                                                            |

**Table 28-2** Variables for creating storage for OCR and voting disk (*continued*)

| Variable            | List or Scalar | Description                                                                                                                                        |
|---------------------|----------------|----------------------------------------------------------------------------------------------------------------------------------------------------|
| \$CFG{votevolname}  | Scalar         | Required<br>Defines the volume name for voting disk. This variable must be used only if you have set the storage scheme to 0 (CVM Raw Volumes).    |
| \$CFG{votevolsize}  | Scalar         | Required<br>Defines the size of the voting disk volume. This variable must be used only if you have set the storage scheme to 0 (CVM Raw Volumes). |
| \$CFG{oracle_user}  | Scalar         | Required<br>Defines the name of the Oracle user.                                                                                                   |
| \$CFG{oracle_group} | Scalar         | Required<br>Defines the primary group of the Oracle user.                                                                                          |

[Table 28-3](#) lists the variables that are used to configure the private IP address and PrivNIC resource under VCS.

**Table 28-3** Variables for configuring the private IP address and PrivNIC resource under VCS

| Variable              | List or Scalar | Description                                                                                                                                                                                                                                                                                             |
|-----------------------|----------------|---------------------------------------------------------------------------------------------------------------------------------------------------------------------------------------------------------------------------------------------------------------------------------------------------------|
| \$CFG{config_privnic} | Scalar         | Required<br>Defines a Boolean value 0 or 1.<br><br>The value 1 indicates that the PrivNIC and private IP address information will be configured for Oracle Clusterware.<br><br>The value 0 indicates that the PrivNIC and private IP address information will not be configured for Oracle Clusterware. |

**Table 28-3** Variables for configuring the private IP address and PrivNIC resource under VCS (*continued*)

| Variable                          | List or Scalar | Description                                                                                                                                                                                                                                                                                                                                                                   |
|-----------------------------------|----------------|-------------------------------------------------------------------------------------------------------------------------------------------------------------------------------------------------------------------------------------------------------------------------------------------------------------------------------------------------------------------------------|
| \$CFG{privnic_resname}            | Scalar         | <p>Required</p> <p>Defines the PrivNIC resource name in the main.cf file.</p>                                                                                                                                                                                                                                                                                                 |
| \$CFG{privnic_interface_priority} | String         | <p>Required</p> <p>Defines the priority that determines which NIC will be used in the event of a failover. Set the priority in decreasing order.</p> <p>For example, the following priority setting indicates that lan2 will be given priority in the event of a failover:</p> <p><b>\$CFG{privnic_interface_priority}="lan2 lan3";</b></p>                                   |
| \$CFG{host1}{privnicip}           | Scalar         | <p>Required</p> <p>Defines the IP address to be configured for the PrivNIC resource on the node.</p> <p>Repeat this variable for each node in the cluster. For example, if you have two nodes in the cluster, you must provide this variable for each node.</p> <p>For example:</p> <pre>\$CFG{sys1}{privnicip} ="192.168.12.1"  \$CFG{sys2}{privnicip} ="192.168.12.2"</pre> |
| \$CFG{nic_reuseip}                | Scalar         | <p>Required</p> <p>Defines a boolean value 0 or 1.</p> <p>The value 1 indicates that the existing IP addresses in the /etc/hosts file will be used.</p> <p>The value 0 indicates that the IP addresses will not be reused.</p>                                                                                                                                                |

**Table 28-3** Variables for configuring the private IP address and PrivNIC resource under VCS (*continued*)

| Variable                                       | List or Scalar | Description                                                                                                                                                                                                                                                                                                                                                                                                                                                                                                              |
|------------------------------------------------|----------------|--------------------------------------------------------------------------------------------------------------------------------------------------------------------------------------------------------------------------------------------------------------------------------------------------------------------------------------------------------------------------------------------------------------------------------------------------------------------------------------------------------------------------|
| \$CFG{ <i>host</i> }{ <i>hostname_for_ip</i> } | Scalar         | <p>Required</p> <p>Defines the private node name of the IP address (<i>hostname_for_ip</i>) for the PrivNIC resource and the node (<i>system</i>) for which the resource is configured.</p> <p>Repeat this variable for each node in the cluster. For example, if you have two nodes in the cluster, you must provide this variable for each node.</p> <p>For example:</p> <pre>\$CFG{<i>sys1</i>}{<i>hostname_for_ip</i>} =<i>sys1-priv</i>"  \$CFG{<i>sys2</i>}{<i>hostname_for_ip</i>} =<i>sys2-priv</i>"</pre>       |
| \$CFG{ <i>nic_netmask</i> }                    | Scalar         | <p>Required</p> <p>Defines the netmask for the private network.</p>                                                                                                                                                                                                                                                                                                                                                                                                                                                      |
| \$CFG{ <i>nic_add_ip_to_files</i> }            | Scalar         | <p>Required</p> <p>Defines a boolean value 0 or 1.</p> <p>The value 1 indicates that the IP addresses are added to the <code>/etc/hosts</code> file.</p> <p><b>Note:</b> Make sure that the IP addresses for the NIC resource are not already present in the files or set the <code>\$CFG{<i>nic_reuseip</i>}</code> and <code>\$CFG{<i>nic_reusealias</i>}</code> variables, otherwise the network configuration step fails.</p> <p>The value 0 indicates that the IP addresses may already be present in the file.</p> |



**Table 28-3** Variables for configuring the private IP address and PrivNIC resource under VCS (*continued*)

| Variable                                 | List or Scalar | Description                                                                                                                                                                                                                                                                                                                                                                                                                                                                                                                                                                                                                       |
|------------------------------------------|----------------|-----------------------------------------------------------------------------------------------------------------------------------------------------------------------------------------------------------------------------------------------------------------------------------------------------------------------------------------------------------------------------------------------------------------------------------------------------------------------------------------------------------------------------------------------------------------------------------------------------------------------------------|
| \$CFG{nic_reconfigure_existing_resource} | Scalar         | Optional<br><br>Defines a boolean value 0 or 1.<br><br>The value 1 indicates that the existing PrivNIC resource in the main.cf file will be deleted and reconfigured.<br><br>The value 0 indicates that the existing PrivNIC resource in the main.cf file will be reused.                                                                                                                                                                                                                                                                                                                                                         |
| \$CFG{nic_reusealias}                    | Scalar         | Required<br><br>Defines a boolean value 0 or 1.<br><br>The value 1 indicates that the installer will not check the <code>/etc/hosts</code> file to determine whether the host name alias for the private IP addresses exist or not. The installer assumes that the host names alias information is present in the file. Make sure that the alias information is present in the file.<br><br>The value 0 indicates that the installer checks whether the host name alias information is present in the <code>/etc/hosts</code> file. Make sure that the alias information is present in the file otherwise the installation fails. |

[Table 28-4](#) lists the variables that are used to configure the private IP addresses and the MultiPrivNIC resource under VCS.

**Table 28-4** Variables for configuring the private IP addresses and the MultiPrivNIC resource under VCS

| Variable                    | List or Scalar | Description                                                                                                                                                                                                                                                                                                                                                                                                                                                                                                |
|-----------------------------|----------------|------------------------------------------------------------------------------------------------------------------------------------------------------------------------------------------------------------------------------------------------------------------------------------------------------------------------------------------------------------------------------------------------------------------------------------------------------------------------------------------------------------|
| \$CFG{config_multiprivnic}  | Scalar         | <p>Required</p> <p>Defines a Boolean value 0 or 1.</p> <p>The value 1 indicates that the MultiPrivNIC and private IP address information will be configured for Oracle Clusterware.</p> <p>The value 0 indicates that the MultiPrivNIC and private IP address information will not be configured for Oracle Clusterware.</p>                                                                                                                                                                               |
| \$CFG{multiprivnic_resname} | Scalar         | <p>Required</p> <p>Defines the MultiPrivNIC resource name in the main.cf file.</p>                                                                                                                                                                                                                                                                                                                                                                                                                         |
| \$CFG{nic_add_ip_to_files}  | Scalar         | <p>Required</p> <p>Defines a boolean value 0 or 1.</p> <p>The value 1 indicates that the IP addresses are added to the <code>/etc/hosts</code> file.</p> <p><b>Note:</b> Make sure that the IP addresses for the NIC resource are not already present in the files or set the <code>\$CFG{nic_reuseip}</code> and <code>\$CFG{nic_reusealias}</code> variables, otherwise the network configuration step fails.</p> <p>The value 0 indicates that the IP addresses may already be present in the file.</p> |

**Table 28-4** Variables for configuring the private IP addresses and the MultiPrivNIC resource under VCS (*continued*)

| Variable                                              | List or Scalar | Description                                                                                                                                                                                                                                                                                                                                                                                                                                                                                                                                                                                                                                                                               |
|-------------------------------------------------------|----------------|-------------------------------------------------------------------------------------------------------------------------------------------------------------------------------------------------------------------------------------------------------------------------------------------------------------------------------------------------------------------------------------------------------------------------------------------------------------------------------------------------------------------------------------------------------------------------------------------------------------------------------------------------------------------------------------------|
| \$CFG{ <i>host1</i> }{ <i>NIC1</i> }{multiprivnicip}  | List           | <p>Required</p> <p>Defines the list of IP addresses for the MultiPrivNIC resource.</p> <p><b>Note:</b> The private IP addresses must be configured for each node and each interface in the cluster.</p> <p>For example, if you have two nodes <i>sys1</i> and <i>sys2</i> in the cluster:</p> <pre>\$CFG{<i>sys1</i>}{<i>lan1</i>}{multiprivnicip}="192.168.12.1"; \$CFG{<i>sys1</i>}{<i>lan2</i>}{multiprivnicip}="192.168.2.1"; \$CFG{<i>sys2</i>}{<i>lan1</i>}{multiprivnicip}="192.168.12.2"; \$CFG{<i>sys2</i>}{<i>lan2</i>}{multiprivnicip}="192.168.2.2";</pre>                                                                                                                    |
| \$CFG{ <i>host1</i> }{ <i>NIC1</i> }{hostname_for_ip} | List           | <p>Required</p> <p>Defines the list of private node names (<i>hostname_for_ip</i>) for the IP addresses configured in the MultiPrivNIC resource for the interface (<i>inf</i>) on the node (<i>system</i>).</p> <p><b>Note:</b> The private IP address must be configured for each node and each interface in the cluster.</p> <p>For example, if you have two nodes <i>sys1</i> and <i>sys2</i> in the cluster:</p> <pre>\$CFG{<i>sys1</i>}{<i>lan1</i>}{hostname_for_ip}="sys1-priv"; \$CFG{<i>sys1</i>}{<i>lan2</i>}{hostname_for_ip}="sys1-priv1"; \$CFG{<i>sys2</i>}{<i>lan1</i>}{hostname_for_ip}="sys2-priv"; \$CFG{<i>sys2</i>}{<i>lan2</i>}{hostname_for_ip}="sys2-priv1";</pre> |

**Table 28-4** Variables for configuring the private IP addresses and the MultiPrivNIC resource under VCS (*continued*)

| Variable                                 | List or Scalar | Description                                                                                                                                                                                                                                                                                                                                                                                                                                                                                                                                                                                                                              |
|------------------------------------------|----------------|------------------------------------------------------------------------------------------------------------------------------------------------------------------------------------------------------------------------------------------------------------------------------------------------------------------------------------------------------------------------------------------------------------------------------------------------------------------------------------------------------------------------------------------------------------------------------------------------------------------------------------------|
| \$CFG{nic_netmask}                       | Scalar         | <p>Required</p> <p>Defines the netmask for the private network.</p>                                                                                                                                                                                                                                                                                                                                                                                                                                                                                                                                                                      |
| \$CFG{nic_reconfigure_existing_resource} | Scalar         | <p>Optional</p> <p>Defines a boolean value 0 or 1.</p> <p>The value 1 indicates that the existing MultiPrivNIC resource in the main.cf file will be deleted and reconfigured.</p> <p>The value 0 indicates that the existing MultiPrivNIC resource in the main.cf file will be reused.</p>                                                                                                                                                                                                                                                                                                                                               |
| \$CFG{nic_reuseip}                       | Scalar         | <p>Required</p> <p>Defines a boolean value 0 or 1.</p> <p>The value 1 indicates that the existing IP addresses in the <code>/etc/hosts</code> file will be used.</p> <p>The value 1 indicates that the existing IP addresses in the <code>/etc/hosts</code> or <code>/etc/inet/ipnodes</code> files will be used.</p> <p>The value 0 indicates that the IP addresses will not be reused.</p>                                                                                                                                                                                                                                             |
| \$CFG{nic_reusealias}                    | Scalar         | <p>Required</p> <p>Defines a boolean value 0 or 1.</p> <p>The value 1 indicates that the installer will not check the <code>/etc/hosts</code> file to determine whether the host name alias for the private IP addresses exist or not. The installer assumes that the host names alias information is present in the file. Make sure that the alias information is present in the file.</p> <p>The value 0 indicates that the installer checks whether the host name alias information is present in the <code>/etc/hosts</code> file. Make sure that the alias information is present in the file otherwise the installation fails.</p> |

Table 28-5 lists the variables that are used to install Oracle Clusterware.

**Table 28-5** Variables for installing Oracle Clusterware

| Variable                          | List or Scalar | Description                                                                                                                                                                                |
|-----------------------------------|----------------|--------------------------------------------------------------------------------------------------------------------------------------------------------------------------------------------|
| \$CFG{install_oracle_clusterware} | Scalar         | Required<br>Defines a Boolean value 0 or 1.<br>The value 1 indicates that Oracle Clusterware will be configured.<br>The value 0 indicates that Oracle Clusterware will not be configured.  |
| \$CFG{oracle_user}                | Scalar         | Required<br>Defines the name of the Oracle user.                                                                                                                                           |
| \$CFG{oracle_group}               | Scalar         | Required<br>Defines the primary group of the Oracle user.                                                                                                                                  |
| \$CFG{oracle_base}                | Scalar         | Required<br>Defines the base directory for the Oracle RAC installation.                                                                                                                    |
| \$CFG{crs_home}                   | Scalar         | Required<br>Defines the Oracle Clusterware home directory.<br>The value in this variable must be the same as that of the 'ORACLE_HOME' variable in the Oracle Clusterware response file.   |
| \$CFG{crs_installpath}            | Scalar         | Required<br>Defines the full path of the Oracle Clusterware installation binaries.                                                                                                         |
| \$CFG{oracle_version}             | Scalar         | Required<br>Defines the version of the Oracle RAC binaries (for example, 11.2.0.3.0). This definition is overridden if a different Oracle RAC version is detected during the installation. |

**Table 28-5** Variables for installing Oracle Clusterware (*continued*)

| Variable                | List or Scalar | Description                                                                    |
|-------------------------|----------------|--------------------------------------------------------------------------------|
| \$CFG{crs_responsefile} | Scalar         | Required<br><br>Defines the full path of the Oracle Clusterware response file. |

Table 28-6 lists the variables that are used to install Oracle database.

**Table 28-6** Variables for installing Oracle database

| Variable                       | List or Scalar | Description                                                                                                                                                                                                     |
|--------------------------------|----------------|-----------------------------------------------------------------------------------------------------------------------------------------------------------------------------------------------------------------|
| \$CFG{install_oracle_database} | Scalar         | Required<br><br>Defines a Boolean value 0 or 1.<br><br>The value 1 indicates that the Oracle RAC database will be configured.<br><br>The value 0 indicates that the Oracle RAC database will not be configured. |
| \$CFG{oracle_user}             | Scalar         | Required<br><br>Defines the name of the Oracle user.                                                                                                                                                            |
| \$CFG{oracle_group}            | Scalar         | Required<br><br>Defines the primary group of the Oracle user.                                                                                                                                                   |
| \$CFG{oracle_base}             | Scalar         | Required<br><br>Defines the base directory for the Oracle RAC installation.                                                                                                                                     |
| \$CFG{crs_home}                | Scalar         | Required<br><br>Defines the Oracle Clusterware home directory.<br><br>The value in this variable must be the same as that of the 'ORACLE_HOME' variable in the Oracle Clusterware response file.                |

**Table 28-6** Variables for installing Oracle database (*continued*)

| Variable               | List or Scalar | Description                                                                                                                                                                                        |
|------------------------|----------------|----------------------------------------------------------------------------------------------------------------------------------------------------------------------------------------------------|
| \$CFG{db_home}         | Scalar         | Required<br><br>Defines the Oracle RAC database home directory.<br><br>The value in this variable must be the same as that of the 'ORACLE_HOME' variable in the Oracle RAC database response file. |
| \$CFG{db_installpath}  | Scalar         | Required<br><br>Defines the full path of the Oracle RAC database installation binaries.                                                                                                            |
| \$CFG{oracle_version}  | Scalar         | Required<br><br>Defines the version of the Oracle RAC binaries (for example, 11.2.0.3.0). This definition is overridden if a different Oracle RAC version is detected during the installation.     |
| \$CFG{db_responsefile} | Scalar         | Required<br><br>Defines the full path of the Oracle database response file.                                                                                                                        |

[Table 28-7](#) lists the variables that are used to configure CSSD resource.

**Table 28-7** Variables for configuring CSSD resource

| Variable                 | List or Scalar | Description                                                                                                                                                                                                                                               |
|--------------------------|----------------|-----------------------------------------------------------------------------------------------------------------------------------------------------------------------------------------------------------------------------------------------------------|
| \$CFG{config_cssd_agent} | Scalar         | Required<br><br>Defines a Boolean value 0 or 1.<br><br>The value 1 indicates that the CSSD agent will be configured after Oracle RAC installation.<br><br>The value 0 indicates that the CSSD agent will not be configured after Oracle RAC installation. |

**Table 28-7** Variables for configuring CSSD resource (*continued*)

| Variable                         | List or Scalar | Description                                                                                                                                                                                                                                                                                                                                                                            |
|----------------------------------|----------------|----------------------------------------------------------------------------------------------------------------------------------------------------------------------------------------------------------------------------------------------------------------------------------------------------------------------------------------------------------------------------------------|
| \$CFG{reconfigure_cssd_resource} | Scalar         | <p>Required</p> <p>Defines a boolean value 0 or 1.</p> <p>The value 1 indicates that the SF Oracle RAC installer deletes the existing CSSD resource from the main.cf file and reconfigures it.</p> <p>The value 0 indicates that the SF Oracle RAC installer does not delete and reconfigure the resource. The installer exits the task with the message that the resource exists.</p> |

[Table 28-8](#) lists the variables that are used to relink Oracle RAC libraries.

**Table 28-8** Variables for relinking Oracle RAC libraries

| Variable                      | List or Scalar | Description                                                                                                                                                                                                                                                                                                                                      |
|-------------------------------|----------------|--------------------------------------------------------------------------------------------------------------------------------------------------------------------------------------------------------------------------------------------------------------------------------------------------------------------------------------------------|
| \$CFG{relink_oracle_database} | Scalar         | <p>Required</p> <p>Defines a Boolean value 0 or 1.</p> <p>The value 1 indicates that the SF Oracle RAC libraries will be relinked with the Oracle RAC database after Oracle RAC installation.</p> <p>The value 0 indicates that the SF Oracle RAC libraries will not be relinked with the Oracle RAC database after Oracle RAC installation.</p> |
| \$CFG{oracle_user}            | Scalar         | <p>Required</p> <p>Defines the name of the Oracle user.</p>                                                                                                                                                                                                                                                                                      |
| \$CFG{oracle_group}           | Scalar         | <p>Required</p> <p>Defines the primary group of the Oracle user.</p>                                                                                                                                                                                                                                                                             |



**Table 28-8** Variables for relinking Oracle RAC libraries (*continued*)

| Variable              | List or Scalar | Description                                                                                                                                                                                        |
|-----------------------|----------------|----------------------------------------------------------------------------------------------------------------------------------------------------------------------------------------------------|
| \$CFG{crs_home}       | Scalar         | Required<br><br>Defines the Oracle Clusterware home directory.<br><br>The value in this variable must be the same as that of the 'ORACLE_HOME' variable in the Oracle Clusterware response file.   |
| \$CFG{db_home}        | Scalar         | Required<br><br>Defines the Oracle RAC database home directory.<br><br>The value in this variable must be the same as that of the 'ORACLE_HOME' variable in the Oracle RAC database response file. |
| \$CFG{oracle_version} | Scalar         | Required<br><br>Defines the version of the Oracle RAC binaries (for example, 11.2.0.3.0). This definition is overridden if a different Oracle RAC version is detected during the installation.     |

## Sample response file for installing Oracle RAC

The following sample response file installs Oracle RAC 11g Release 2 and performs the following Oracle RAC pre-installation and installation tasks on two nodes, sys1 and sys2, in the cluster:

- Creates a disk group for OCR and voting disk storage
- Creates OCR and voting disk storage on raw volumes
- Configures the PrivNIC agent for high availability on both nodes
- Installs Oracle Clusterware
- Installs Oracle database
- Relinks the Oracle RAC libraries with SF Oracle RAC libraries
- Configures the CSSD agent

```
#
Configuration Values:
#
our %CFG;

$CFG{prod}="SFRAC601";
$CFG{systems}=[qw(sys1 sys2)];
$CFG{opt}{configure}=1;

$CFG{config_privnic}=1;
$CFG{privnic_resname}="ora_priv";
$CFG{privnic_interface_priority}="lan2 lan3";
$CFG{sys1}{privnicip}=" 192.168.12.1";
$CFG{sys1}{hostname_for_ip}="sys1-priv";
$CFG{sys2}{privnicip}=" 192.168.12.2";
$CFG{sys2}{hostname_for_ip}="sys2-priv";
$CFG{nic_netmask}="255.255.255.0";
$CFG{nic_add_ip_to_files}=1;
$CFG{nic_reuseip}=1;
$CFG{nic_reusealias}=1;

$CFG{create_ocr_vote_storage}=1;
$CFG{ocrvotedgoption}=0;
$CFG{oracle_group}="dba";
$CFG{grid_user}="grid";
$CFG{oracle_user}="oracle";
$CFG{ocrvolname}="ocrvotevol";
$CFG{ocrvolsize}=640;
$CFG{enable_mirroring} = 1;
$CFG{ocrvotedgname}="ocrvotedg";
$CFG{ocrvotedisks}=[qw(Disk_1 Disk_2)];
$CFG{ocrvotescheme}=0;
$CFG{votevolname}="votevol";
$CFG{votevolsize}=500;

$CFG{install_oracle_clusterware}=1;
$CFG{install_oracle_database}=1;
$CFG{oracle_base} = "/u01/app/oracle";
$CFG{crs_home}="/u01/app/oracle/product/11.2.0/crshome";
$CFG{db_home}="/u01/app/oracle/product/11.2.0/dbhome_1";
$CFG{crs_installpath}="/cdrom/oracle/clusterware";
$CFG{db_installpath}="/cdrom/oracle/database";
$CFG{crs_responsefile}="/oracle/crs.rsp";
```

```
$CFG{db_responsefile} = "/oracle/db.rsp";

$CFG{config_cssd_agent}=1;
$CFG{relink_oracle_database}=1;
$CFG{uploadlogs}=0;

1;
```

# Adding and removing nodes

- [Chapter 29. Adding a node to SF Oracle RAC clusters](#)
- [Chapter 30. Removing a node from SF Oracle RAC clusters](#)

# Adding a node to SF Oracle RAC clusters

This chapter includes the following topics:

- [About adding a node to a cluster](#)
- [Before adding a node to a cluster](#)
- [Adding a node to a cluster using the SF Oracle RAC installer](#)
- [Adding a node using the Web-based installer](#)
- [Adding the node to a cluster manually](#)
- [Configuring Cluster Volume Manager \(CVM\) and Cluster File System \(CFS\) on the new node](#)
- [Preparing the new node for installing Oracle RAC](#)
- [Adding the new node to Oracle RAC](#)
- [Adding nodes to a cluster that is using authentication for SFDB tools](#)
- [Updating the Storage Foundation for Databases \(SFDB\) repository after adding a node](#)

## About adding a node to a cluster

After you install SF Oracle RAC and create a cluster, you can add and remove nodes from the cluster. You can create clusters of up to 16 nodes.

You can add a node:

- Using the product installer

- Using the Web installer
- Manually

The following table provides a summary of the tasks required to add a node to an existing SF Oracle RAC cluster.

**Table 29-1** Tasks for adding a node to a cluster

| Step                                                                                                         | Description                                                                                                                                                                                                                                                   |
|--------------------------------------------------------------------------------------------------------------|---------------------------------------------------------------------------------------------------------------------------------------------------------------------------------------------------------------------------------------------------------------|
| Complete the prerequisites and preparatory tasks before adding a node to the cluster.                        | See <a href="#">“Before adding a node to a cluster”</a> on page 414.                                                                                                                                                                                          |
| Add a new node to the cluster.                                                                               | See <a href="#">“Adding a node to a cluster using the SF Oracle RAC installer”</a> on page 417.<br>See <a href="#">“Adding a node using the Web-based installer”</a> on page 421.<br>See <a href="#">“Adding the node to a cluster manually”</a> on page 422. |
| Complete the configuration of the new node after adding it to the cluster.                                   | See <a href="#">“Configuring Cluster Volume Manager (CVM) and Cluster File System (CFS) on the new node”</a> on page 432.                                                                                                                                     |
| Prepare the new node for installing Oracle.                                                                  | See <a href="#">“Preparing the new node for installing Oracle RAC”</a> on page 434.                                                                                                                                                                           |
| Add the node to Oracle.                                                                                      | See <a href="#">“Adding the new node to Oracle RAC”</a> on page 458.                                                                                                                                                                                          |
| If you are using the Storage Foundation for Databases (SFDB) tools, you must update the repository database. | See <a href="#">“Adding nodes to a cluster that is using authentication for SFDB tools”</a> on page 459.<br>See <a href="#">“Updating the Storage Foundation for Databases (SFDB) repository after adding a node”</a> on page 460.                            |

The example procedures describe how to add a node to an existing cluster with two nodes.

## Before adding a node to a cluster

Before preparing to add the node to an existing SF Oracle RAC cluster, perform the required preparations.

- Verify hardware and software requirements are met.
- Set up the hardware.
- Prepare the new node.

**To verify hardware and software requirements are met**

- 1 Review hardware and software requirements for SF Oracle RAC.
- 2 Verify the new system has the same identical operating system versions and patch levels as that of the existing cluster
- 3 Verify the existing cluster is an SF Oracle RAC cluster and that SF Oracle RAC is running on the cluster.
- 4 If the cluster is upgraded from the previous version, you must check the cluster protocol version to make sure it has the same version as the node to be added. If there is a protocol mismatch, the node is unable to join the existing cluster.

Check the cluster protocol version using:

```
vxdctl protocolversion
Cluster running at protocol 120
```

- 5 If the cluster protocol on the master node is below 120, upgrade it using:

```
vxdctl upgrade [version]
```

Before you configure a new system on an existing cluster, you must physically add the system to the cluster as illustrated in [Figure 29-1](#).

**Figure 29-1** Adding a node to a two-node cluster using two switches

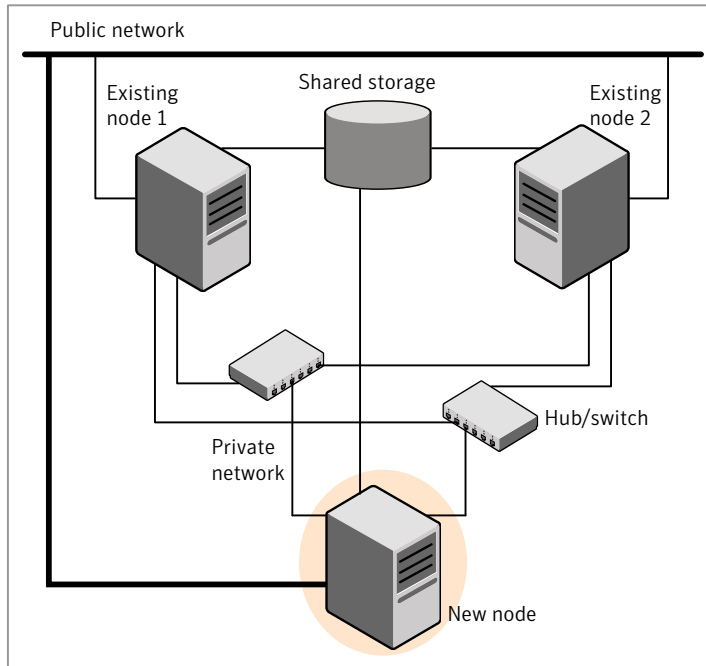

**To set up the hardware**

- 1 Connect the SF Oracle RAC private Ethernet controllers.

Perform the following tasks as necessary:

- When you add nodes to a cluster, use independent switches or hubs for the private network connections.
- If you already use independent hubs, connect the two Ethernet controllers on the new node to the independent hubs.

Figure 29-1 illustrates a new node being added to an existing two-node cluster using two independent hubs.

- 2 Make sure that you meet the following requirements:

- The node must be connected to the same shared storage devices as the existing nodes.
- The node must have private network connections to two independent switches for the cluster.

For more information, see the *Veritas Cluster Server Installation Guide*.



- The network interface names used for the private interconnects on the new node must be the same as that of the existing nodes in the cluster.

Complete the following preparatory steps on the new node before you add it to an existing SF Oracle RAC cluster.

#### To prepare the new node

- 1 Verify that the new node meets installation requirements.

```
./installsfrac -precheck
```

You can also use the Web-based installer for the precheck.

- 2 Install SF Oracle RAC on the new system. Make sure all the VRTS depots available on the existing nodes are also available on the new node.

```
cd /opt/VRTS/install
```

```
./installsfrac<version>
```

Where *<version>* is the specific release version.

Do not configure SF Oracle RAC when prompted.

- 3 The installer copies the configuration files on the new node. Install the SF Oracle RAC-based depots on new node. Restart the node if the installer asks for a reboot.

## Adding a node to a cluster using the SF Oracle RAC installer

You can add a node to a cluster using the `-addnode` option with the SF Oracle RAC installer.

The SF Oracle RAC installer performs the following tasks:

- Verifies that the node and the existing cluster meet communication requirements.
- Verifies the products and depots installed but not configured on the new node.
- Discovers the network interfaces on the new node and checks the interface settings.
- Creates the following files on the new node:  
`/etc/l1ttab`  
`/etc/VRTSvcs/conf/sysname`
- Copies the following files on the new node:

```

/etc/llthosts
/etc/gabtab
/etc/VRTSvcs/conf/config/main.cf

```

- Copies the following files from the existing cluster to the new node:

```

/etc/vxfenmode
/etc/vxfendg
/etc/vcsmmtab
/etc/vx/.uuids/clusuid
/etc/rc.config.d/lltconf
/etc/rc.config.d/gabconf
/etc/rc.config.d/vcsconf
/etc/rc.config.d/vxfenconf
/etc/default/vcsmm
/etc/default/amf

```

- Generate security credentials on the new node if the CPS server of existing cluster is secure
- Configures disk-based or server-based fencing depending on the fencing mode in use on the existing cluster.
- Adds the new node to the CVM, ClusterService, and VxSS service groups in the VCS configuration.

---

**Note:** For other service groups configured under VCS, update the configuration for the new node manually.

---

- Starts SF Oracle RAC processes and configures CVM and CFS on the new node.

At the end of the process, the new node joins the SF Oracle RAC cluster.

---

**Note:** If you have configured server-based fencing on the existing cluster, make sure that the CP server does not contain entries for the new node. If the CP server already contains entries for the new node, remove these entries before adding the node to the cluster, otherwise the process may fail with an error.

---



---

**Caution:** If you plan to use the SF Oracle RAC installer for completing the Oracle pre-installation tasks on the new node, do not quit the installer after adding the node to the cluster. If you quit the installer, you must perform the Oracle pre-installation tasks manually.

---

**To add the node to an existing cluster using the installer**

- 1 Log in as the root user on one of the nodes of the existing cluster.
- 2 Run the SF Oracle RAC installer with the `-addnode` option.

```
cd /opt/VRTS/install

./installsfrac<version> -addnode
```

Where `<version>` is the specific release version.

See [“About the Veritas installer”](#) on page 77.

The installer displays the copyright message and the location where it stores the temporary installation logs.

- 3 Enter the name of a node in the existing SF Oracle RAC cluster.

The installer uses the node information to identify the existing cluster.

```
Enter one node of the SF Oracle RAC cluster to which
you would like to add one or more new nodes: sys1
```

- 4 Review and confirm the cluster information.
- 5 Enter the name of the systems that you want to add as new nodes to the cluster.

```
Enter the system names separated by spaces
to add to the cluster: sys5
```

Confirm if the installer prompts if you want to add the node to the cluster.

The installer checks the installed products and depots on the nodes and discovers the network interfaces.

- 6 Enter the name of the network interface that you want to configure as the first private heartbeat link.

---

**Note:** The network interface names used for the private interconnects on the new node must be the same as that of the existing nodes in the cluster. The LLT configuration for the new node must be the same as that of the existing cluster.

---

```
Enter the NIC for the first private heartbeat
link on sys5: [b,q,?] lan1
```

```
Enter the NIC for the second private heartbeat
link on sys5: [b,q,?] lan2
```

---

**Note:** At least two private heartbeat links must be configured for high availability of the cluster.

---

- 7 Depending on the number of LLT links configured in the existing cluster, configure additional private heartbeat links for the new node.  
 The installer verifies the network interface settings and displays the information.
- 8 Review and confirm the information.
- 9 If you have configured SMTP, SNMP, or the global cluster option in the existing cluster, you are prompted for the NIC information for the new node.

```
Enter the NIC for VCS to use on sys5: lan3
```

```
SF Oracle RAC is configured on the cluster. Do you want to
configure it on the new node(s)? [y,n,q] (y) n
```

- 10 If the existing cluster uses server-based fencing in secure mode, the installer will configure server-based fencing in secure mode on the new nodes.

The installer then starts all the required Veritas processes and joins the new node to cluster.

---

**Note:** Do not quit the installer if you want to perform the Oracle pre-installation tasks using the SF Oracle RAC installer.

---

The installer indicates the location of the log file, summary file, and response file with details of the actions performed.

- 11 Confirm that the new node has joined the SF Oracle RAC cluster using `lltstat -n` and `gabconfig -a` commands.

If the new node has not joined the cluster, verify if it has been added to the SystemList.

## Adding a node using the Web-based installer

You can use the Web-based installer to add a node to a cluster.

### To add a node to a cluster using the Web-based installer

- 1 From the Task pull-down menu, select **Add a Cluster node**.

From the product pull-down menu, select the product.

Click the **Next** button.

- 2 Click **OK** to confirm the prerequisites to add a node.

- 3 In the System Names field enter a name of a node in the cluster where you plan to add the node and click **OK**.

The installer program checks inter-system communications and compatibility. If the node fails any of the checks, review the error and fix the issue.

If prompted, review the cluster's name, ID, and its systems. Click the **Yes** button to proceed.

- 4 In the System Names field, enter the names of the systems that you want to add to the cluster as nodes. Separate system names with spaces. Click the **Next** button.

The installer program checks inter-system communications and compatibility. If the system fails any of the checks, review the error and fix the issue.

Click the **Next** button. If prompted, click the **Yes** button to add the system and to proceed.

- 5 From the heartbeat NIC pull-down menus, select the heartbeat NICs for the cluster. Click the **Next** button.
- 6 Complete the preparatory steps for adding Oracle RAC on the new node.  
 See [“Preparing the new nodes for installing Oracle RAC using the SF Oracle RAC Web-based installer”](#) on page 442.
- 7 Once the addition is complete, review the log files. Optionally send installation information to Symantec. Click the **Finish** button to complete the node's addition to the cluster.

## Adding the node to a cluster manually

Perform this procedure after you install SF Oracle RAC only if you plan to add the node to the cluster manually.

**Table 29-2** Procedures for adding a node to a cluster manually

| Step                                                                                                                                                                                                                             | Description                                                                                                               |
|----------------------------------------------------------------------------------------------------------------------------------------------------------------------------------------------------------------------------------|---------------------------------------------------------------------------------------------------------------------------|
| Start the Veritas Volume Manager (VxVM) on the new node.                                                                                                                                                                         | See <a href="#">“Starting Veritas Volume Manager (VxVM) on the new node”</a> on page 423.                                 |
| Configure the cluster processes on the new node.                                                                                                                                                                                 | See <a href="#">“Configuring cluster processes on the new node”</a> on page 423.                                          |
| If the CPS server of existing cluster is secure, generate security credentials on the new node.                                                                                                                                  | See <a href="#">“Setting up the node to run in secure mode”</a> on page 426.                                              |
| Configure fencing for the new node to match the fencing configuration on the existing cluster.<br><br>If the existing cluster is configured to use server-based I/O fencing, configure server-based I/O fencing on the new node. | See <a href="#">“Starting fencing on the new node”</a> on page 429.                                                       |
| Start VCS.                                                                                                                                                                                                                       | See <a href="#">“To start VCS on the new node”</a> on page 430.                                                           |
| Configure CVM and CFS.                                                                                                                                                                                                           | See <a href="#">“Configuring Cluster Volume Manager (CVM) and Cluster File System (CFS) on the new node”</a> on page 432. |

**Table 29-2** Procedures for adding a node to a cluster manually (*continued*)

| Step                                                                                          | Description |
|-----------------------------------------------------------------------------------------------|-------------|
| If the ClusterService group is configured on the existing cluster, add the node to the group. |             |

## Starting Veritas Volume Manager (VxVM) on the new node

Veritas Volume Manager (VxVM) uses license keys to control access. As you run the `vxinstall` utility, answer **n** to prompts about licensing. You installed the appropriate license when you ran the `installsfrac` program.

### To start VxVM on the new node

- 1 To start VxVM on the new node, use the `vxinstall` utility:

```
vxinstall
```

- 2 VxVM uses license keys to control access. As you run the utility, answer "n" when prompted about licensing; you installed the appropriate license when you ran the `installsfrac` utility.

- 3 Enter **n** when prompted to set up a system wide disk group for the system. The installation completes.

- 4 Verify that the daemons are up and running. Enter the command:

```
vxdisk list
```

Make sure the output displays the shared disks without errors.

## Configuring cluster processes on the new node

Perform the steps in the following procedure to configure cluster processes on the new node.

**To configure cluster processes on the new node on the new node**

- 1 Edit the `/etc/llthosts` file on the existing nodes. Using `vi` or another text editor, add the line for the new node to the file. The file resembles:

```
0 sys1
1 sys2
2 sys5
```

- 2 Copy the `/etc/llthosts` file from one of the existing systems over to the new system. The `/etc/llthosts` file must be identical on all nodes in the cluster.
- 3 Create an `/etc/llttab` file on the new system. For example:

```
set-node sys5
set-cluster 101

link lan1 /dev/lan:1 - ether --
link lan2 /dev/lan:2 - ether --
```

Except for the first line that refers to the node, the file resembles the `/etc/llttab` files on the existing nodes. The second line, the cluster ID, must be the same as in the existing nodes.

- 4 Use `vi` or another text editor to create the file `/etc/gabtab` on the new node. This file must contain a line that resembles the following example:

```
/sbin/gabconfig -c -nN
```

Where `N` represents the number of systems in the cluster including the new node. For a three-system cluster, `N` would equal 3.

- 5 Edit the `/etc/gabtab` file on each of the existing systems, changing the content to match the file on the new system.
- 6 Copy the following files from one of the nodes in the existing cluster to the new node:

```
/etc/rc.config.d/lltconf
/etc/rc.config.d/gabconf
/etc/rc.config.d/vcsconf
/etc/rc.config.d/lmxconf
/etc/rc.config.d/vcsmmconf
/etc/rc.config.d/vxfenconf
/etc/vcsmmtab
```



- 7 Use vi or another text editor to create the file `/etc/VRTSvcs/conf/sysname` on the new node. This file must contain the name of the new node added to the cluster.

For example:

```
sys5
```

- 8 Create the Unique Universal Identifier file `/etc/vx/.uuids/clusuid` on the new node:

```
/opt/VRTSvcs/bin/uuidconfig.pl -rsh -clus -copy \
-from_sys sys1 -to_sys sys5
```

- 9 Start the LLT, GAB, VCSMM, LMX, and ODM drivers on the new node:

```
/sbin/init.d/llt start
/sbin/init.d/gab start
/sbin/init.d/vxfen start
/sbin/init.d/vcsmm start
/sbin/init.d/lmx start
kcmodule vxgms=loaded
kcmodule odm=loaded
/sbin/init.d/odm stop
/sbin/init.d/odm start
```

- 10 On the new node, verify that the GAB port memberships are a, d, and o:

```
gabconfig -a
```

```
GAB Port Memberships
```

```
=====
```

|            |                      |
|------------|----------------------|
| Port a gen | df204 membership 012 |
| Port d gen | df20a membership 012 |
| Port o gen | df207 membership 012 |

## Setting up the node to run in secure mode

You must follow this procedure only if you are adding a node to a cluster that is running in secure mode. If you are adding a node to a cluster that is not running in a secure mode, proceed with configuring LLT and GAB.

[Table 29-3](#) uses the following information for the following command examples.

**Table 29-3** The command examples definitions

| Name | Fully-qualified host name (FQHN) | Function                                         |
|------|----------------------------------|--------------------------------------------------|
| sys5 | sys5.nodes.example.com           | The new node that you are adding to the cluster. |

## Configuring the authentication broker on node sys5

To configure the authentication broker on node sys5

- 1 Extract the embedded authentication files and copy them to temporary directory:

```
mkdir -p /var/VRTSvcs/vcsauth/bkup
cd /tmp; gunzip -c /opt/VRTSvcs/bin/VxAT.tar.gz | tar xvf -
```

- 2 Edit the setup file manually:

```
cat /etc/vx/.uuids/clusuuid 2>&1
```

The output is a string denoting the UUID. This UUID (without { and }) is used as the ClusterName for the setup file.

```
{UUID}
```

```
cat /tmp/eat_setup 2>&1
```

The file content must resemble the following example:

```
AcceptorMode=IP_ONLY

BrokerExeName=vcsauthserver

ClusterName=UUID

DataDir=/var/VRTSvcs/vcsauth/data/VCSAUTHSERVER

DestDir=/opt/VRTSvcs/bin/vcsauth/vcsauthserver

FipsMode=0

IPPort=14149

RootBrokerName=vcsroot_uuid

SetToRBPlusABorNot=0

SetupPDRs=1

SourceDir=/tmp/VxAT/version
```

**3** Set up the embedded authentication file:

```
cd /tmp/VxAT/version/bin/edition_number; \
./broker_setup.sh/tmp/eat_setup

/opt/VRTSvcs/bin/vcsauth/vcsauthserver/bin/vssregctl -s -f \
/var/VRTSvcs/vcsauth/data/VCSAUTHSERVER/root/.VRTSat/profile \
/VRTSatlocal.conf -b 'Security\Authentication \
\Authentication Broker' -k UpdatedDebugLogFileName \
-v /var/VRTSvcs/log/vcsauthserver.log -t string
```

**4** Copy the broker credentials from one node in the cluster to sys5 by copying the entire `bkup` directory.

The `bkup` directory content resembles the following example:

```
cd /var/VRTSvcs/vcsauth/bkup/

ls

CMDSERVER CPSADM CPSEVER HAD VCS_SERVICES WAC
```

**5** Import the `VCS_SERVICES` domain.

```
/opt/VRTSvcs/bin/vcsauth/vcsauthserver/bin/atutil import -z \
/var/VRTSvcs/vcsauth/data/VCSAUTHSERVER -f /var/VRTSvcs/vcsauth/bkup \
/VCS_SERVICES -p password
```

**6** Import the credentials for `HAD`, `CMDSERVER`, `CPSADM`, `CPSEVER`, and `WAC`.

```
/opt/VRTSvcs/bin/vcsauth/vcsauthserver/bin/atutil import -z \
/var/VRTSvcs/vcsauth/data/VCS_SERVICES -f /var/VRTSvcs/vcsauth/bkup \
/HAD -p password
```

**7** Start the `vcsauthserver` process on `sys5`.

```
/opt/VRTSvcs/bin/vcsauth/vcsauthserver/bin/vcsauthserver.sh
```

**8** Perform the following tasks:

```
mkdir /var/VRTSvcs/vcsauth/data/CLIENT
mkdir /var/VRTSvcs/vcsauth/data/TRUST
export EAT_DATA_DIR='/var/VRTSvcs/vcsauth/data/TRUST'
/opt/VRTSvcs/bin/vcsauth/vcsauthserver/bin/vssat setuptrust -b \
localhost:14149 -s high
```

**9** Create the `/etc/VRTSvcs/conf/config/.secure` file:

```
touch /etc/VRTSvcs/conf/config/.secure
```

## Starting fencing on the new node

Perform the following steps to start fencing on the new node.

**To start fencing on the new node**

- 1** For disk-based fencing on at least one node, copy the following files from one of the nodes in the existing cluster to the new node:

```
/etc/rc.config.d/vxfenconf
/etc/vxfendg
/etc/vxfenmode
```

If you are using pure CP server-based fencing on the existing cluster, then only the `/etc/vxfenmode` file needs to be copied on the new node.

- 2** Start fencing on the new node:

```
/sbin/init.d/vxfen start
```

- 3** On the new node, verify that the GAB port memberships are a, b, d, and o:

```
gabconfig -a
```

```
GAB Port Memberships
```

```
=====
Port a gen df204 membership 012
Port b gen df20d membership 012
Port d gen df20a membership 012
Port o gen df207 membership 012
```

## After adding the new node

If you added the new node to the cluster manually, before you starting VCS you must create the file `cssd-pretend-offline` on the new node and make the `cssd` resource non-critical. Failing this, the `cssd` resource lapses into an UNKNOWN state until Oracle Clusterware is installed on the new node, thus preventing the `cvm` group from coming online.

If you used the product installer to add the new node to the cluster, you will not need to perform this step.

---

**Note:** The `cssd` resource will remain in FAULTED/OFFLINE state till Oracle Clusterware is installed on the new node.

---

Start VCS on the new node.

### To start VCS on the new node

- 1 If you installed the new node manually:
  - On one of the nodes in the existing cluster, configure the `cssd` resource as a non-critical resource:

```
haconf -makerw
hares -modify cssd Critical 0
haconf -dump -makero
```

- Create the file `cssd-pretend-offline` on the new node:

```
touch /var/VRTSvcs/lock/cssd-pretend-offline
```

- 2 Start VCS on the new node:

```
hastart
```

VCS brings the CVM group online.

- 3 Verify that the CVM group is online:

---

**Note:** The CVM group reports `Partial` state till Oracle Clusterware/Grid Infrastructure is installed on the new node.

---

```
hagrps -state
```

## Configuring server-based fencing on the new node

This section describes the procedures to configure server-based fencing on a new node. Depending on whether server-based fencing is configured in secure or non-secure mode on the existing cluster, perform the tasks in one of the following procedures:

- Server-based fencing in non-secure mode:  
[To configure server-based fencing in non-secure mode on the new node](#)
- Server-based fencing in secure mode:  
[To configure server-based fencing with security on the new node](#)

### To configure server-based fencing in non-secure mode on the new node

- 1 Log in to each CP server as the root user.
- 2 Update each CP server configuration with the new node information:

```
cpsadm -s cps1.symantecexample.com \
-a add_node -c clus1 -h sys5 -n2
```

```
Node 2 (sys5) successfully added
```

- 3 Verify that the new node is added to the CP server configuration:

```
cpsadm -s cps1.symantecexample.com \
-a list_nodes
```

The new node must be listed in the command output.

- 4 Add the VCS user cpsclient@sys5 to each CP server:

```
cpsadm -s cps1.symantecexample.com \
-a add_user -e cpsclient@sys5 \
-f cps_operator -g vx
```

```
User cpsclient@sys5 successfully added
```

**Configuring Cluster Volume Manager (CVM) and Cluster File System (CFS) on the new node****To configure server-based fencing with security on the new node**

- 1 Log in to each CP server as the root user.
- 2 Update each CP server configuration with the new node information:

```
cpsadm -s cps1.symantecexample.com \
-a add_node -c clus1 -h sys5 -n2
```

```
Node 2 (sys5) successfully added
```

- 3 Verify that the new node is added to the CP server configuration:

```
cpsadm -s cps1.symantecexample.com -a list_nodes
```

The new node must be listed in the output.

**Adding the new node to the vxfen service group**

Perform the steps in the following procedure to add the new node to the vxfen service group.

**To add the new node to the vxfen group using the CLI**

- 1 On one of the nodes in the existing SF Oracle RAC cluster, set the cluster configuration to read-write mode:

```
haconf -makerw
```

- 2 Add the node sys5 to the existing vxfen group.

```
hagrps -modify vxfen SystemList -add sys5 2
```

- 3 Save the configuration by running the following command from any node in the SF Oracle RAC cluster:

```
haconf -dump -makero
```

# Configuring Cluster Volume Manager (CVM) and Cluster File System (CFS) on the new node

Modify the existing cluster configuration to configure Cluster Volume Manager (CVM) and Cluster File System (CFS) for the new node.



**Configuring Cluster Volume Manager (CVM) and Cluster File System (CFS) on the new node****To configure CVM and CFS on the new node**

- 1 Make a backup copy of the main.cf file on the existing node, if not backed up in previous procedures. For example:

```
cd /etc/VRTSvcs/conf/config
cp main.cf main.cf.2node
```

- 2 On one of the nodes in the existing cluster, set the cluster configuration to read-write mode:

```
haconf -makerw
```

- 3 Add the new node to the VCS configuration, if not already added:

```
hasys -add sys5
```

- 4 To enable the existing cluster to recognize the new node, run the following commands on one of the existing nodes:

```
hagrps -modify cvm SystemList -add sys5 2
hagrps -modify cvm AutoStartList -add sys5
hares -modify cvm_clus CVMNodeId -add sys5 2
haconf -dump -makero
/etc/vx/bin/vxclustadm -m vcs reinit
/etc/vx/bin/vxclustadm nidmap
```

- 5 On the remaining nodes of the existing cluster, run the following commands:

```
/etc/vx/bin/vxclustadm -m vcs reinit
/etc/vx/bin/vxclustadm nidmap
```

- 6 Copy the configuration files from one of the nodes in the existing cluster to the new node:

```
rcp /etc/VRTSvcs/conf/config/main.cf \
sys5:/etc/VRTSvcs/conf/config/main.cf
rcp /etc/VRTSvcs/conf/config/CFSTypes.cf \
sys5:/etc/VRTSvcs/conf/config/CFSTypes.cf
rcp /etc/VRTSvcs/conf/config/CVMTypes.cf \
sys5:/etc/VRTSvcs/conf/config/CVMTypes.cf
```

- 7 The `/etc/vx/tunefstab` file sets non-default tunables for local-mounted and cluster-mounted file systems.

If you have configured a `/etc/vx/tunefstab` file to tune cluster-mounted file systems on any of the existing cluster nodes, you may want the new node to adopt some or all of the same tunables.

To adopt some or all tunables, review the contents of the file, and copy either the file, or the portions desired, into the `/etc/vx/tunefstab` file on the new cluster node.

## Preparing the new node for installing Oracle RAC

You must complete certain pre-installation tasks before you add the node to Oracle RAC.

---

**Note:** Use or resume the same installer session that was invoked for adding the node to the cluster. If you quit the session, the add node options for installing Oracle RAC are not displayed.

The instructions in this chapter use variables and sample values wherever required. Replace these variables and sample values with values that conform to your installation requirements.

Before you start the preparatory tasks, you may want to update the sample worksheet with the correct installation values and keep them handy during the process.

---

Use one of the following ways to complete the preparatory tasks:

Using the SF Oracle RAC script-based installer

See [“Preparing the new nodes for installing Oracle RAC using the SF Oracle RAC script-based installer”](#) on page 435.

Using the SF Oracle RAC  
Web-based installer

See [“Preparing the new nodes for installing Oracle RAC using the SF Oracle RAC Web-based installer”](#) on page 442.

Manual

See [“Preparing the new node manually for installing Oracle RAC”](#) on page 450.

---

**Note:** Some of the pre-installation tasks can be completed using the SF Oracle RAC installer while some of the tasks must be completed manually as indicated in the procedures.

---

## Preparing the new nodes for installing Oracle RAC using the SF Oracle RAC script-based installer

The SF Oracle RAC installer performs the following tasks:

- Creates the Oracle user and groups on the new node
- Configures the private IP addresses and the PrivNIC or MultiPrivNIC resources (if they are configured in the existing cluster).
- If the CFSMount and CVMVoIDg resources for OCR and voting disk are configured under the `cvm` service group, the installer brings them online after adding the node to the cluster.

If the resources are configured in any other service group, make sure that you modify the service group to include the new node and bring the service group online.

---

**Note:** If OCR and voting disk are not configured under VCS, manually mount the OCR and voting disk after you finish the steps in the following procedure.

---

- Starts the CVM group on the new node.

**To prepare to install Oracle RAC on the new node using the SF Oracle RAC installer**

**1** After you configure SF Oracle RAC on the new node, the installer displays the following options for configuring Oracle RAC:

- 1) Create Oracle User and Group
- 2) Configure private IP addresses (PrivNIC configuration)
- 3) Configure private IP addresses (MultiPrivNIC configuration)
- 4) Finish

---

**Note:** Depending on whether you configured the private IP addresses as PrivNIC or MultiPrivNIC resources in the existing cluster, either option 2 or 3 are displayed.

---

Enter **1** to select the option **Create Oracle User and Group** from the SF Oracle RAC installer menu.

See [“Creating Oracle user and groups on the new node”](#) on page 438.

**2** Configure the private IP addresses and the PrivNIC resource for Oracle Clusterware (only if the IP addresses on the existing cluster are configured as PrivNIC resources).

You must manually update the PrivNIC resource configuration in the following cases:

- If the PrivNIC resource on the existing cluster is configured under a group other than `cvm`.
- If the `Device` attribute in the PrivNIC resource configuration on the existing cluster is not configured for each node as follows:

```
Device@sys1 = {lan1=0, lan2=1}
Device@sys2 = {lan1=0, lan2=1}
```

Enter **2** to select the option **Configure private IP addresses (PrivNIC configuration)**.

See [“Configuring the private IP addresses and PrivNIC resource for Oracle Clusterware”](#) on page 439.

**3** Configure private IP addresses and the MultiPrivNIC resource for Oracle Clusterware and Oracle UDP IPC (only if the IP addresses on the existing cluster are configured as MultiPrivNIC resources).

You must manually update the MultiPrivNIC resource configuration in the following cases:

- If the MultiPrivNIC resource on the existing cluster is configured under a group other than `cvm`.

- If the `Device` attribute in the MultiPrivNIC resource configuration on the existing cluster is not configured for each node as follows:

```
Device@sys1 = {lan1=0, lan2=1, lan3=2}
```

```
Device@sys2 = {lan1=0, lan2=1, lan3=2}
```

Enter **3** to select the option **Configure private IP addresses (MultiPrivNIC configuration)**.

See [“Configuring the private IP addresses and MultiPrivNIC resource for Oracle Clusterware and Oracle UDP IPC”](#) on page 441.

- 4 Select **Finish** to start the `cvm` group on the new node.

---

**Note:** The `cssd` resource appears **FAULTED** until the new node is added to Oracle Clusterware.

---

- 5 If the `cssd` resource is configured as a critical resource, the `cvm` group will be brought offline on the new node. Modify the configuration to make the `cssd` resource non-critical and bring the `cvm` group online.

- On one of the nodes in the existing cluster, configure the `cssd` resource as a non-critical resource:

```
haconf -makerw
```

```
hares -modify cssd Critical 0
```

```
haconf -dump -makero
```

- Bring the `cvm` group online:

```
hares -online cvm -sys sys5
```

## 6 Verify that all the GAB ports are up:

```
gabcnfig -a
```

```
GAB Port Memberships
```

```
=====
Port a gen ada401 membership 012
Port b gen ada40d membership 012
Port d gen ada409 membership 012
Port f gen ada41c membership 012
Port h gen ada40f membership 012
Port o gen ada406 membership 012
Port u gen ada416 membership 012
Port v gen ada416 membership 012
Port w gen ada418 membership 012
Port y gen ada419 membership 012
```

- 7 Complete the following additional preparatory tasks using the instructions in the chapter "Preparing to install Oracle RAC":
  - Identify public virtual IP addresses for use by Oracle RAC.
  - Set the kernel parameters.
  - Verify that the user "nobody" exists.
  - Set up Oracle user equivalence for remote shell and remote copy environments.
  - Edit the Oracle user profile.
  - If the OCR and voting disk resources are not configured under VCS, mount the OCR and voting disk manually.
- 8 Create Oracle Clusterware and Oracle RAC database home directories manually.

See ["Creating Oracle Clusterware/Grid Infrastructure and Oracle database home directories on the new node"](#) on page 454.

## Creating Oracle user and groups on the new node

Perform the steps in the following procedure to create Oracle user and groups on the new node.

---

**Note:** Set the password of the Oracle user manually before you configure secure shell or remote shell connection on the node.

---

### To create Oracle user and groups on the new node

- 1 Enter the Oracle user name that is used for Oracle RAC operations on the existing cluster.

---

**Note:** If the Oracle user and groups already exist on the new node, make sure that the UID and GID of the Oracle user and groups are the same as that on the current cluster.

---

```
Enter Oracle UNIX user name: [b] oracle
```

The installer obtains the existing group and identifier information based on the Oracle user name.

- 2 Review and confirm the information.  
The installer adds the user and groups to the new node.
- 3 Press **Return** to continue with the other configuration tasks.

### Configuring the private IP addresses and PrivNIC resource for Oracle Clusterware

Perform this step only if the private IP addresses are configured as PrivNIC resources in the existing cluster.

---

**Note:** Make sure that the network interface names of the private interconnects on the new node are the same as those of the existing cluster. For maximum failover options, all available LLT links are used for PrivNIC configuration.

---

Review the pre-configuration information displayed by the installer and ensure that you meet the requirements.

**To configure the private IP addresses and PrivNIC resource for Oracle Clusterware**

- 1** Enter the name for the PrivNIC resource. The installer displays the names of the existing PrivNIC resources. Specify the name of an existing resource.

```
Enter the PrivNIC resource name: [b] (ora_priv)
```

- 2** Enter **y** if you want the installer to add the IP address to the `/etc/hosts` file. You can also add the IP address to the file manually after the configuration. The installer displays the existing PrivNIC resource configuration on the cluster.

```
Resource name: ora_priv
System: sys1
 Private Interfaces: lan1 lan2
 Private IP address: 192.168.12.1
 Alias for above IP: sys1-priv
System: sys2
 Private Interfaces: lan1 lan2
 Private IP address: 192.168.12.2
 Alias for above IP: sys2-priv
Is this information correct? [y,n,q] (y)
```

- 3** Review and confirm the information.
- 4** Enter the private IP address and its private node name for the new node.

```
Enter the private IP for sys5: [b] 192.168.12.5
Enter Hostname alias for the above IP address: [b] sys5-priv
```

The installer displays the resource configuration for the new node.

```
Resource name: ora_priv
System: sys5
 Private Interfaces: lan1 lan2
 Private IP address: 192.168.12.5
 Alias for above IP: sys5-priv
Is this information correct? [y,n,q] (y)
```

- 5** Review and confirm the information. The installer updates the existing PrivNIC resource with the resource configuration for the new node and updates the `/etc/hosts` file on the new node as well as on the existing nodes (if you chose to update the file through the installer).
- 6** Press **Return** to continue with the other configuration tasks.



## Configuring the private IP addresses and MultiPrivNIC resource for Oracle Clusterware and Oracle UDP IPC

Perform this step only if the private IP addresses are configured as MultiPrivNIC resources in the existing cluster.

---

**Note:** Make sure that you configure the same interfaces (as those on the existing cluster) for private interconnects on the new node. For maximum failover options, all available LLT links are used for MultiPrivNIC configuration.

---

Review the pre-configuration information displayed by the installer and ensure that you meet the requirements.

### To configure the private IP addresses and MultiPrivNIC resource for Oracle Clusterware and Oracle UDP IPC

- 1 Enter the name for the MultiPrivNIC resource. The installer displays the names of the existing MultiPrivNIC resources. Specify the name of an existing resource.

```
Enter the MultiPrivNIC resource name: [b] (multi_priv)
```

- 2 Enter **y** if you want the installer to add the IP address to the `/etc/hosts` file. You can also add the IP address to the file manually after the configuration. The installer displays the existing MultiPrivNIC resource configuration on the cluster.

```
Resource name: multi_priv
System: sys1
 Private Interfaces: lan1 lan2
 Private IPs on lan1: 192.168.12.1
 Aliases for above IPs: sys1-priv
 Private IPs on lan2: 192.168.2.1
 Aliases for above IPs: sys1-priv1
System: sys2
 Private Interfaces: lan1 lan2
 Private IPs on lan1: 192.168.12.2
 Aliases for above IPs: sys2-priv
 Private IPs on lan2: 192.168.2.2
 Aliases for above IPs: sys2-priv1
Is this information correct? [y,n,q] (y)
```

- 3 Review and confirm the information.

- 4 Enter the private IP address and the corresponding private node name for the lan1 interface on the new node.

```
Enter IP addresses for sys5 for lan1
separated by space: [b,q,?] 192.168.12.5
Enter Hostname aliases for the above IP addresses
separated by space: [b,q,?] sys5-priv
```

- 5 Enter the private IP address and the corresponding private node name for the lan2 interface on the new node.

```
Enter IP addresses for sys5 for lan2
separated by space: [b,q,?] 192.168.2.6
Enter Hostname aliases for the above IP addresses
separated by space: [b,q,?] sys5-priv1
```

The installer displays the resource configuration for the new node.

```
Resource name: multi_priv
System: sys5
 Private Interfaces: lan1 lan2
 Private IPs on lan1: 192.168.12.5
 Aliases for above IPs: sys5-priv
 Private IPs on lan2: 192.168.2.6
 Aliases for above IPs: sys5-priv1
Is this information correct? [y,n,q] (y)
```

- 6 Review and confirm the information.

The installer updates the existing MultiPrivNIC resource with the resource configuration for the new node and updates the `/etc/hosts` file on the new node as well as on the existing nodes (if you chose to update the file through the installer).

- 7 Press **Return** to continue with the other configuration tasks.

## Preparing the new nodes for installing Oracle RAC using the SF Oracle RAC Web-based installer

The SF Oracle RAC installer performs the following tasks:

- Creates the Oracle user and groups on the new node
- Configures the private IP addresses and the PrivNIC or MultiPrivNIC resources (if they are configured in the existing cluster).

- If the CFSSMount and CVMVolDg resources for OCR and voting disk are configured under the `cvm` service group, the installer brings them online after adding the node to the cluster.  
 If the resources are configured in any other service group, make sure that you modify the service group to include the new node and bring the service group online.

---

**Note:** If OCR and voting disk are not configured under VCS, manually mount the OCR and voting disk after you finish the steps in the following procedure.

---

- Starts the CVM group on the new node.

**To prepare to install Oracle RAC on the new node using the SF Oracle RAC installer**

- 1 After you configure SF Oracle RAC on the new node, the installer displays the following options for configuring Oracle RAC:

```

Create Oracle User and Group
Configure private IP addresses (PrivNIC configuration)
Configure private IP addresses (MultiPrivNIC configuration)
Finish

```

---

**Note:** Depending on whether you configured the private IP addresses as PrivNIC or MultiPrivNIC resources in the existing cluster, either option 2 or 3 is displayed.

---

Select the option **Create Oracle User and Group** from the SF Oracle RAC installer menu. Click **Next**.

See [“Creating Oracle user and groups on the new node”](#) on page 438.

- 2 Configure the private IP addresses and the PrivNIC resource for Oracle Clusterware (only if the IP addresses on the existing cluster are configured as PrivNIC resources).

You must manually update the PrivNIC resource configuration in the following cases:

- If the PrivNIC resource on the existing cluster is configured under a group other than `cvm`.
- If the `Device` attribute in the PrivNIC resource configuration on the existing cluster is not configured for each node as follows:

```

Device@sys1 = {lan1=0, lan2=1}
Device@sys2 = {lan1=0, lan2=1}

```

Select the option **Configure private IP addresses (PrivNIC configuration)**. Click **Next**.

See [“Configuring the private IP addresses and PrivNIC resource for Oracle Clusterware”](#) on page 439.

- 3 Configure private IP addresses and the MultiPrivNIC resource for Oracle Clusterware and Oracle UDP IPC (only if the IP addresses on the existing cluster are configured as MultiPrivNIC resources).

You must manually update the MultiPrivNIC resource configuration in the following cases:

- If the MultiPrivNIC resource on the existing cluster is configured under a group other than `cvm`.
- If the `Device` attribute in the MultiPrivNIC resource configuration on the existing cluster is not configured for each node as follows:

```
Device@sys1 = {lan1=0, lan2=1, lan3=2}
Device@sys2 = {lan1=0, lan2=1, lan3=2}
```

Select the option **Configure private IP addresses (MultiPrivNIC configuration)**. Click **Next**.

See [“Configuring the private IP addresses and MultiPrivNIC resource for Oracle Clusterware and Oracle UDP IPC”](#) on page 441.

- 4 Select **Finish** to start the `cvm` group on the new node.

---

**Note:** The `cssd` resource appears **FAULTED** until the new node is added to Oracle Clusterware.

---

- 5 If the `cssd` resource is configured as a critical resource, the `cvm` group will be brought offline on the new node. Modify the configuration to make the `cssd` resource non-critical and bring the `cvm` group online.

- On one of the nodes in the existing cluster, configure the `cssd` resource as a non-critical resource:

```
haconf -makerw
hares -modify cssd Critical 0
haconf -dump -makero
```

- Bring the `cvm` group online:

```
hares -online cvm -sys sys5
```

## 6 Verify that all the GAB ports are up:

```
gabcnfig -a
```

```
GAB Port Memberships
```

```
=====
Port a gen ada401 membership 012
Port b gen ada40d membership 012
Port d gen ada409 membership 012
Port f gen ada41c membership 012
Port h gen ada40f membership 012
Port o gen ada406 membership 012
Port u gen ada416 membership 012
Port v gen ada416 membership 012
Port w gen ada418 membership 012
Port y gen ada419 membership 012
```

- 7 Complete the following additional preparatory tasks using the instructions in the chapter "Preparing to install Oracle RAC":
  - Identify public virtual IP addresses for use by Oracle RAC.
  - Set the kernel parameters.
  - Verify that the user "nobody" exists.
  - Set up Oracle user equivalence for remote shell and remote copy environments.
  - Edit the Oracle user profile.
  - If the OCR and voting disk resources are not configured under VCS, mount the OCR and voting disk manually.
- 8 Create Oracle Clusterware and Oracle RAC database home directories manually.

See ["Creating Oracle Clusterware/Grid Infrastructure and Oracle database home directories on the new node"](#) on page 454.

## Creating Oracle user and groups on the new node

Perform the steps in the following procedure to create Oracle user and groups on the new node.

---

**Note:** Set the password of the Oracle user manually before you configure secure shell or remote shell connection on the node.

---

### To create Oracle user and groups on the new node

- 1 Enter the Oracle user name that is used for Oracle RAC operations on the existing cluster.

---

**Note:** If the Oracle user and groups already exist on the new node, make sure that the UID and GID of the Oracle user and groups are the same as that on the current cluster.

---

Enter Oracle UNIX user name:

Click **Next**. The installer obtains the existing group and identifier information based on the Oracle user name.

- 2 Review and confirm the information.  
The installer adds the user and groups to the new node.
- 3 Enter the information for the secondary group, if required.
- 4 Click **Yes** to continue with the other configuration tasks.

### Configuring the private IP addresses and PrivNIC resource for Oracle Clusterware

Perform this step only if the private IP addresses are configured as PrivNIC resources in the existing cluster.

---

**Note:** Make sure that the network interface names of the private interconnects on the new node are the same as those of the existing cluster. For maximum failover options, all available LLT links are used for PrivNIC configuration.

---

Review the pre-configuration information displayed by the installer and ensure that you meet the requirements.

**To configure the private IP addresses and PrivNIC resource for Oracle Clusterware**

- 1** Enter the name for the PrivNIC resource. The installer displays the names of the existing PrivNIC resources. Specify the name of an existing resource.

Enter the PrivNIC resource name:

Click **Next**.

- 2** Click **Yes** if you want the installer to add the IP address to the `/etc/hosts` file. You can also add the IP address to the file manually after the configuration. The installer displays the existing PrivNIC resource configuration on the cluster.

```
Resource name: ora_priv
System: sys1
 Private Interfaces: lan1 lan2
 Private IP address: 192.168.12.1
 Alias for above IP: sys1-priv
System: sys2
 Private Interfaces: lan1 lan2
 Private IP address: 192.168.12.2
 Alias for above IP: sys2-priv
Is this information correct?
```

- 3** Review and confirm the information.
- 4** Enter the private IP address and its private node name for the new node.

```
Enter the private IP for sys5: 192.168.12.5
Enter Hostname alias for the above IP address:sys5-priv
```

Click **Next**.

The installer displays the resource configuration for the new node.

```
Resource name: ora_priv
System: sys5
 Private Interfaces: lan1 lan2
 Private IP address: 192.168.12.5
 Alias for above IP: sys5-priv
Is this information correct?
```

- 5 Review and confirm the information.

The installer updates the existing PrivNIC resource with the resource configuration for the new node and updates the `/etc/hosts` file on the new node as well as on the existing nodes (if you chose to update the file through the installer).

- 6 Click **Yes** to continue with the other configuration tasks.

## Configuring the private IP addresses and MultiPrivNIC resource for Oracle Clusterware and Oracle UDP IPC

Perform this step only if the private IP addresses are configured as MultiPrivNIC resources in the existing cluster.

---

**Note:** Make sure that you configure the same interfaces (as those on the existing cluster) for private interconnects on the new node. For maximum failover options, all available LLT links are used for MultiPrivNIC configuration.

---

Review the pre-configuration information displayed by the installer and ensure that you meet the requirements.



**To configure the private IP addresses and MultiPrivNIC resource for Oracle Clusterware and Oracle UDP IPC**

- 1 Enter the name for the MultiPrivNIC resource. The installer displays the names of the existing MultiPrivNIC resources. Specify the name of an existing resource.

Enter the MultiPrivNIC resource name:

Click **Yes**.

- 2 Click **Yes** if you want the installer to add the IP address to the `/etc/hosts` file. You can also add the IP address to the file manually after the configuration. The installer displays the existing MultiPrivNIC resource configuration on the cluster.

```
Resource name: multi_priv
System: sys1
 Private Interfaces: lan1 lan2
 Private IPs on lan1: 192.168.12.1
 Aliases for above IPs: sys1-priv
 Private IPs on lan2: 192.168.2.1
 Aliases for above IPs: sys1-priv1
System: sys2
 Private Interfaces: lan1 lan2
 Private IPs on lan1: 192.168.12.2
 Aliases for above IPs: sys2-priv
 Private IPs on lan2: 192.168.2.2
 Aliases for above IPs: sys2-priv1
Is this information correct?
```

- 3 Review and confirm the information.
- 4 Enter the private IP address and the corresponding private node name for the lan1 interface on the new node.

```
Enter IP addresses for sys5 for lan1
separated by space: 192.168.12.5
Enter Hostname aliases for the above IP addresses
separated by space: sys5-priv
```

Click **Next**.

- 5 Enter the private IP address and the corresponding private node name for the lan2 interface on the new node.

Enter IP addresses for sys5 for lan2  
 separated by space: **192.168.2.6**

Enter Hostname aliases for the above IP addresses  
 separated by space: **sys5-priv1**

Click **Next**.

The installer displays the resource configuration for the new node.

```
Resource name: multi_priv
System: sys5
 Private Interfaces: lan1 lan2
 Private IPs on lan1: 192.168.12.5
 Aliases for above IPs: sys5-priv
 Private IPs on lan2: 192.168.2.6
 Aliases for above IPs: sys5-priv1
Is this information correct?
```

- 6 Review and confirm the information.

The installer updates the existing MultiPrivNIC resource with the resource configuration for the new node and updates the `/etc/hosts` file on the new node as well as on the existing nodes (if you chose to update the file through the installer).

- 7 Click **Yes** to continue with the other configuration tasks.

## Preparing the new node manually for installing Oracle RAC

Complete the following preparatory tasks manually before you install Oracle RAC on the new node.

### To prepare to install Oracle RAC on the new node

- 1 Create Oracle user and groups.
- 2 Configure private IP addresses and the PrivNIC resource for Oracle Clusterware.

See [“Configuring private IP address and PrivNIC resource for Oracle Clusterware”](#) on page 451.

- 3 Configure private IP addresses and the MultiPrivNIC resource for Oracle Clusterware and Oracle UDP IPC.  
 See [“Configuring private IP addresses and MultiPrivNIC resource for Oracle Clusterware and UDP IPC”](#) on page 452.
- 4 Start VCS on the new node.  
 See [“Starting VCS on the new node”](#) on page 453.
- 5 Create the Oracle Clusterware/Grid Infrastructure and Oracle RAC database home directories for installation.  
 See [“Creating Oracle Clusterware/Grid Infrastructure and Oracle database home directories on the new node ”](#) on page 454.
- 6 Complete the following additional preparatory tasks using the instructions in the chapter "Preparing to install Oracle RAC":
  - Identify public virtual IP addresses for use by Oracle RAC.
  - Set the kernel parameters.
  - Verify that the user "nobody" exists.
  - Set up Oracle user equivalence for remote shell and remote copy environments.
  - Edit the Oracle user profile.

## **Configuring private IP address and PrivNIC resource for Oracle Clusterware**

This section provides instructions for configuring private IP address and PrivNIC resource for Oracle Clusterware.

Identify a private IP address that you want to use for the new node. Make sure that the IP address is in the same subnet as the existing cluster.

The procedure uses the following IP address for the new node:

On sys5: 192.168.12.5

## To configure private IP addresses for Oracle Clusterware

- 1 Make a backup copy of the main.cf file. For example:

```
cd /etc/VRTSvcs/conf/config
cp main.cf main.cf.2node
```

- 2 Add the private IP address to the the `ora_priv` resource on the active node:

```
haconf -makerw

hares -modify priv_resname Device -add nic1_node1 0 \
-sys nodenew_name

hares -modify priv_resname Device -add nic2_node1 1 \
-sys nodenew_name

hares -modify priv_resname Address "privnic_ip_newnode" \
-sys nodenew_name

haconf -dump -makero
```

## Configuring private IP addresses and MultiPrivNIC resource for Oracle Clusterware and UDP IPC

This section provides instructions for configuring private IP addresses and MultiPrivNIC resource for Oracle Clusterware and UDP IPC.

Identify the private IP addresses that you want to use for the new node. Make sure that the IP addresses are in the same subnet as the existing cluster.

The procedure uses the following IP addresses for the new node:

|                               |              |
|-------------------------------|--------------|
| IP addresses for the new node | 192.168.12.5 |
|                               | 192.168.2.6  |

### To configure private IP addresses for Oracle Clusterware

- ◆ Use the following commands to add private IP into multi\_priv resource on the active node:

```
haconf -makerw

hares -modify multipriv_resname Device -add lan1 0 \
-sys nodenew_name

hares -modify multipriv_resname Device -add lan2 1 \
-sys nodenew_name

hares -modify multipriv_resname Address -add \
multipriv_ip_newnode 0 -sys nodenew_name

hares -modify multipriv_resname Address -add \
multipriv_udpip1_newnode 1 -sys nodenew_name

haconf -dump -makero
```

### Starting VCS on the new node

Before you start VCS, create the file `cssd-pretend-offline` on the new node and make the `cssd` resource non-critical. Failing this, the `cssd` resource lapses into an UNKNOWN state until Oracle Clusterware is installed on the new node, thus preventing the `cvm` group from coming online.

---

**Note:** The `cssd` resource will remain in FAULTED/OFFLINE state till Oracle Clusterware is installed on the new node.

---

**To start VCS on the new node**

- 1 On one of the nodes in the existing cluster, configure the `cssd` resource as a non-critical resource:

```
haconf -makerw
hares -modify cssd Critical 0
haconf -dump -makero
```

- 2 Create the file `cssd-pretend-offline` on the new node:

```
touch /var/VRTSvcs/lock/cssd-pretend-offline
```

- 3 Start VCS on the new node:

```
hstart
```

## Creating Oracle Clusterware/Grid Infrastructure and Oracle database home directories on the new node

The Oracle Clusterware/Grid Infrastructure and Oracle database home directories must be located on the same storage as that on the existing nodes.

---

**Note:** In the case of Oracle RAC 11g Release 1, only the database is supported. References to Oracle RAC 11g Release 1 in the procedure applies to the Oracle database alone.

---

Depending on the storage in the existing cluster, use one of the following options to create the directories:

- |                     |                                                                                                                                                |
|---------------------|------------------------------------------------------------------------------------------------------------------------------------------------|
| Local file system   | See <a href="#">“To create the directories on the local file system”</a> on page 454.                                                          |
| Cluster File System | See <a href="#">“To create the file system and directories on cluster file system for Oracle Clusterware and Oracle database”</a> on page 457. |

**To create the directories on the local file system**

- 1 Log in as the root user on the node.
- 2 Create a local file system and mount it using one of the following methods:
  - Using native operating system commands  
For instructions, see the operating system documentation.
  - Using Veritas File System (VxFS) commands

As the root user, create a VxVM local diskgroup on each node.

```
vxpdg init vxvm_dg \
dg_name
```

Create separate volumes for Oracle Clusterware/Oracle Grid Infrastructure binaries and Oracle binaries.

```
vxassist -g vxvm_dg make clus_volname size
vxassist -g vxvm_dg make ora_volname size
```

Create the file systems with the volumes.

```
mkfs -F vxfs /dev/vx/rdisk/vxvm_dg/clus_volname
mkfs -F vxfs /dev/vx/rdisk/vxvm_dg/ora_volname
```

Mount the file system.

```
mount -F vxfs /dev/vx/dsk/vxvm_dg/clus_volname \
clus_home
mount -F vxfs /dev/vx/dsk/vxvm_dg/ora_volname \
oracle_home
```

### 3 Create the directories for Oracle RAC.

For Oracle RAC 10g Release 2/Oracle RAC 11g Release 1:

```
mkdir -p oracle_base
mkdir -p clus_home
mkdir -p oracle_home
```

For Oracle RAC 11g Release 2:

```
mkdir -p grid_base
mkdir -p clus_home
mkdir -p oracle_base
mkdir -p oracle_home
```

**4** Set appropriate ownership and permissions for the directories.

For Oracle RAC 10g Release 2/Oracle RAC 11g Release 1:

```
chown -R oracle:oinstall clus_home
chmod -R 775 clus_home
```

For Oracle RAC 11g Release 2:

```
chown -R grid:oinstall grid_base
chmod -R 775 grid_base
chown -R grid:oinstall clus_home
chmod -R 775 clus_home
chown -R oracle:oinstall oracle_base
chmod -R 775 oracle_base
chown -R oracle:oinstall oracle_home
chmod -R 775 oracle_home
```

**5** Add the resources to the VCS configuration.

See [“To add the storage resources created on VxFS to the VCS configuration”](#) on page 456.

**6** Repeat all the steps on each new node of the cluster.

**To add the storage resources created on VxFS to the VCS configuration**

**1** Change the permissions on the VCS configuration file:

```
haconf -makerw
```

**2** Configure the VxVM volumes under VCS:

```
hares -add dg_resname DiskGroup cvm
hares -modify dg_resname DiskGroup vxvm_dg -sys nodenew_name
hares -modify dg_resname Enabled 1
```



### 3 Set up the file system under VCS:

```
hares -add clusbin_mnt_resname Mount cvm

hares -modify clusbin_mnt_resname MountPoint \
"clus_home"

hares -modify clusbin_mnt_resname BlockDevice \
"/dev/vx/dsk/vxvm_dg/clus_volname" -sys nodenew_name
hares -modify clusbin_mnt_resname FSType vxfs
hares -modify clusbin_mnt_resname FsckOpt "-n"
hares -modify clusbin_mnt_resname Enabled 1
hares -add orabin_mnt_resname Mount cvm

hares -modify orabin_mnt_resname MountPoint \
"oracle_home"

hares -modify orabin_mnt_resname BlockDevice \
"/dev/vx/dsk/vxvm_dg/ora_volname" -sys nodenew_name
hares -modify orabin_mnt_resname FSType vxfs
hares -modify orabin_mnt_resname FsckOpt "-n"
hares -modify orabin_mnt_resname Enabled 1
```

### 4 Link the parent and child resources:

```
hares -link clusbin_mnt_resname vxvm_dg
hares -link orabin_mnt_resname vxvm_dg
```

### 5 Repeat all the steps on each new node of the cluster.

To create the file system and directories on cluster file system for Oracle Clusterware and Oracle database

Perform the following steps on the CVM master node in the cluster.

- 1 Create the Oracle base directory, clusterware home directory, and the Oracle home directory.

For Oracle RAC 10g Release 2/Oracle RAC 11g Release 1:

```
mkdir -p oracle_base
mkdir -p clus_home
mkdir -p oracle_home
```

For Oracle RAC 11g Release 2:

```
mkdir -p oracle_base
mkdir -p oracle_home
mkdir -p clus_home
mkdir -p grid_base
```

- 2 Mount the file systems. Perform this step on each new node.

```
mount -F vxfs -o cluster /dev/vx/dsk/cvm_dg/clus_volname \
clus_home
mount -F vxfs -o cluster /dev/vx/dsk/cvm_dg/ora_volname \
oracle_home
```

## Adding the new node to Oracle RAC

Install Oracle Clusterware and Oracle RAC database on the node using the Oracle RAC add node procedure.

For instructions, see the Oracle RAC documentation.

After installing Oracle Clusterware and Oracle RAC database, perform the following post-installation tasks:

1. Delete the file `/var/VRTSvcs/lock/cssd-pretend-offline` on the new node.

Clear the fault and probe the cssd resource on the new node to bring the cssd resource online.

```
hares -clear cssd
hares -probe cssd -sys sys5
```

2. If the cssd resource was configured as a non-critical resource, reconfigure it as a critical resource.

```
haconf -makerw
hares -modify cssd Critical 1
haconf -dump -makero
```

3. If `cssd` is not configured under the `cvm` group, add the new node information to the service group containing the `cssd` resource.
4. Add new Oracle RAC database instances for the new node.  
For instructions, see the Oracle RAC documentation.
5. For Oracle RAC 10g Release 2/Oracle RAC 11g Release 1: Add Oracle UDP IPC private IP addresses to the Oracle `init.ora` file.  
  
See [“Adding Oracle UDP IPC private IP addresses to the Oracle initialization parameter file”](#) on page 332.
6. Update the Oracle RAC database service groups to include the new database instances in the VCS configuration file.
7. For other service groups that are configured under VCS, manually update the service group configuration for the new node.

## Adding nodes to a cluster that is using authentication for SFDB tools

To add a node to a cluster that is using authentication for SFDB tools, perform the following steps as the root user

- 1 Export authentication data from a node in the cluster that has already been authorized, by using the `-o export_broker_config` option of the `sfae_auth_op` command.

Use the `-f` option to provide a file name in which the exported data is to be stored.

```
/opt/VRTS/bin/sfae_auth_op \
-o export_broker_config -f exported-data
```

- 2 Copy the exported file to the new node by using any available copy mechanism such as `scp` or `rcp`.

**Updating the Storage Foundation for Databases (SFDB) repository after adding a node**

- 3 Import the authentication data on the new node by using the `-o import_broker_config` option of the `sfae_auth_op` command. Use the `-f` option to provide the name of the file copied in Step 2.

```
/opt/VRTS/bin/sfae_auth_op \
-o import_broker_config -f exported-data
Setting up AT
Importing broker configuration
Starting SFAE AT broker
```

- 4 Stop the `vxdbd` daemon on the new node.

```
/opt/VRTS/bin/vxdbdctrl stop
Stopping Veritas vxdbd
vxdbd stop succeeded
```

- 5 Enable authentication by setting the `AUTHENTICATION` key to `yes` in the `/etc/vx/vxdbed/admin.properties` configuration file.

If `/etc/vx/vxdbed/admin.properties` does not exist, then use `cp /opt/VRTSdbed/bin/admin.properties.example /etc/vx/vxdbed/admin.properties`.

- 6 Start the `vxdbd` daemon.

```
/opt/VRTS/bin/vxdbdctrl start
Starting Veritas vxdbd
/opt/VRTSdbed/bin/vxdbd start SUCCESS
```

The new node is now authenticated to interact with the cluster to run SFDB commands.

## Updating the Storage Foundation for Databases (SFDB) repository after adding a node

If you are using Database Storage Checkpoints, Database FlashSnap, or SmartTier for Oracle in your configuration, update the SFDB repository to enable access for the new node after it is added to the cluster.

**To update the SFDB repository after adding a node**

- 1 Copy the `/var/vx/vxdba/rep_loc` file from one of the nodes in the cluster to the new node.
- 2 If the `/var/vx/vxdba/auth/user-authorizations` file exists on the existing cluster nodes, copy it to the new node.

If the `/var/vx/vxdba/auth/user-authorizations` file does not exist on any of the existing cluster nodes, no action is required.

This completes the addition of the new node to the SFDB repository.

For information on using SFDB tools features:

See *Veritas Storage Foundation: Storage and Availability Management for Oracle Databases*

# Removing a node from SF Oracle RAC clusters

This chapter includes the following topics:

- [About removing a node from a cluster](#)
- [Removing a node from a cluster](#)
- [Modifying the VCS configuration files on existing nodes](#)
- [Modifying the Cluster Volume Manager \(CVM\) configuration on the existing nodes to remove references to the deleted node](#)
- [Removing the node configuration from the CP server](#)
- [Removing security credentials from the leaving node](#)
- [Updating the Storage Foundation for Databases \(SFDB\) repository after removing a node](#)
- [Sample configuration file for removing a node from the cluster](#)

## About removing a node from a cluster

You can remove one or more nodes from an SF Oracle RAC cluster. The following table provides a summary of the tasks required to add a node to an existing SF Oracle RAC cluster.

**Table 30-1** Tasks for removing a node from a cluster

| Step                                                                                                                                                                                                                                                                                               | Description                                                                                                                                                                                                                                                  |
|----------------------------------------------------------------------------------------------------------------------------------------------------------------------------------------------------------------------------------------------------------------------------------------------------|--------------------------------------------------------------------------------------------------------------------------------------------------------------------------------------------------------------------------------------------------------------|
| Prepare to remove the node: <ul style="list-style-type: none"> <li>■ Back up the configuration file.</li> <li>■ Check the status of the nodes and the service groups.</li> <li>■ Take the service groups offline and removing the database instances.</li> </ul>                                   | See <a href="#">“Removing a node from a cluster”</a> on page 463.                                                                                                                                                                                            |
| Remove the node from the cluster.                                                                                                                                                                                                                                                                  | See <a href="#">“Removing a node from a cluster”</a> on page 463.                                                                                                                                                                                            |
| Modify the cluster configuration on remaining nodes. <ul style="list-style-type: none"> <li>■ Edit the /etc/llhosts file.</li> <li>■ Edit the /etc/gabtab file.</li> <li>■ Modify the VCS configuration to remove the node.</li> <li>■ Modify the CVM configuration to remove the node.</li> </ul> | See <a href="#">“Modifying the VCS configuration files on existing nodes”</a> on page 465.<br><br>See <a href="#">“Modifying the Cluster Volume Manager (CVM) configuration on the existing nodes to remove references to the deleted node”</a> on page 467. |
| If the existing cluster is configured to use server-based I/O fencing, remove the node configuration from the Coordination Point (CP) server.                                                                                                                                                      | See <a href="#">“Removing the node configuration from the CP server”</a> on page 467.                                                                                                                                                                        |
| For a cluster that is running in a secure mode, remove the security credentials from the leaving node.                                                                                                                                                                                             | See <a href="#">“Removing security credentials from the leaving node ”</a> on page 468.                                                                                                                                                                      |
| Updating the Storage Foundation for Databases (SFDB) repository after removing a node                                                                                                                                                                                                              | See <a href="#">“Updating the Storage Foundation for Databases (SFDB) repository after removing a node”</a> on page 469.                                                                                                                                     |

The Veritas product installer does not support removing a node. You must remove a node manually. The example procedures describe how to remove a node from a cluster with three nodes.

## Removing a node from a cluster

Perform the following steps to remove a node from a cluster. The procedure can be done from any node remaining in the cluster or from a remote host.

**To prepare to remove a node from a cluster**

- 1 Take the Oracle RAC service groups offline (if under VCS control) on the node you want to remove.

```
hagrpl -offline oracle_group -sys sys5
```

- 2 Stop the applications that use Veritas File System (VxFS) or Cluster File System (CFS) mount points and are not configured under VCS. Use native application commands to stop the applications.
- 3 Remove the Oracle RAC database software from the node.  
For instructions, see the Oracle RAC documentation.
- 4 Remove Oracle Clusterware from the node.  
For instructions, see the Oracle RAC document.

**To remove a node from a cluster**

- 1 Unmount the VxFS/CFS file systems that are not configured under VCS.

```
umount mount_point
```

- 2 Stop VCS on the node:

```
hastop -local
```

- 3 Uninstall SF Oracle RAC from the node using the SF Oracle RAC installer.

```
cd /opt/VRTS/install
```

```
./uninstallsfrac sys5
```

The installer stops all SF Oracle RAC processes and uninstalls the SF Oracle RAC depots.

- 4 Modify the VCS configuration files on the existing nodes to remove references to the deleted node.  
See [“Modifying the VCS configuration files on existing nodes”](#) on page 465.
- 5 Modify the Cluster Volume Manager (CVM) configuration on the existing nodes to remove references to the deleted node.

See [“Modifying the Cluster Volume Manager \(CVM\) configuration on the existing nodes to remove references to the deleted node”](#) on page 467.



# Modifying the VCS configuration files on existing nodes

Modify the configuration files on the remaining nodes of the cluster to remove references to the deleted nodes.

Tasks for modifying the cluster configuration files:

- Edit the `/etc/llhosts` file
- Edit the `/etc/gabtab` file
- Modify the VCS configuration to remove the node

For an example `main.cf`:

## To edit the `/etc/llhosts` file

- ◆ On each of the existing nodes, edit the `/etc/llhosts` file to remove lines that contain references to the removed nodes.

For example, if `sys5` is the node removed from the cluster, remove the line "2 `sys5`" from the file:

```
0 sys1
1 sys2
2 sys5
```

Change to:

```
0 sys1
1 sys2
```

## To edit the `/etc/gabtab` file

- ◆ Modify the following command in the `/etc/gabtab` file to reflect the number of systems after the node is removed:

```
/sbin/gabconfig -c -nN
```

where `N` is the number of remaining nodes in the cluster.

For example, with two nodes remaining, the file resembles:

```
/sbin/gabconfig -c -n2
```

Modify the VCS configuration file `main.cf` to remove all references to the deleted node.

Use one of the following methods to modify the configuration:

- **Edit the `/etc/VRTSvcs/conf/config/main.cf` file**  
 This method requires application down time.
- **Use the command line interface**  
 This method allows the applications to remain online on all remaining nodes.

The following procedure uses the command line interface and modifies the sample VCS configuration to remove references to the deleted node. Run the steps in the procedure from one of the existing nodes in the cluster. The procedure allows you to change the VCS configuration while applications remain online on the remaining nodes.

**To modify the cluster configuration using the command line interface (CLI)**

- 1 **Back up the `/etc/VRTSvcs/conf/config/main.cf` file.**

```
cd /etc/VRTSvcs/conf/config
cp main.cf main.cf.3node.bak
```

- 2 **Change the cluster configuration to read-write mode:**

```
haconf -makerw
```

- 3 **Remove the node from the `AutoStartList` attribute of the service group by specifying the remaining nodes in the desired order:**

```
hagrps -modify cvm AutoStartList sys1 sys2
```

- 4 **Remove the node from the `SystemList` attribute of the service group:**

```
hagrps -modify cvm SystemList -delete sys5
```

If the system is part of the `SystemList` of a parent group, it must be deleted from the parent group first.

- 5 **Remove the node from the `CVMNodeId` attribute of the service group:**

```
hares -modify cvm_clus CVMNodeId -delete sys5
```

- 6 **If you have the other service groups (such as the database service group or the `ClusterService` group) that have the removed node in their configuration, perform step 4 and step 5 for each of them.**

- 7 **Remove the deleted node from the `NodeList` attribute of all CFS mount resources:**

```
hares -modify CFSMount NodeList -delete sys5
```

## Modifying the Cluster Volume Manager (CVM) configuration on the existing nodes to remove references to the deleted node

- 8 Remove the deleted node from the system list of any other service groups that exist on the cluster. For example, to delete the node sys5:

```
hagrps -modify crsgrp SystemList -delete sys5
```

- 9 Remove the deleted node from the cluster system list:

```
hasys -delete sys5
```

- 10 Save the new configuration to disk:

```
haconf -dump -makero
```

- 11 Verify that the node is removed from the VCS configuration.

```
grep -i sys5 /etc/VRTSvcs/conf/config/main.cf
```

If the node is not removed, use the VCS commands as described in this procedure to remove the node.

## Modifying the Cluster Volume Manager (CVM) configuration on the existing nodes to remove references to the deleted node

To modify the CVM configuration on the existing nodes to remove references to the deleted node

- ◆ On the remaining nodes of the existing cluster, run the following commands:

```
/etc/vx/bin/vxclustadm -m vcs reinit
/etc/vx/bin/vxclustadm nidmap
```

## Removing the node configuration from the CP server

After removing a node from a SF Oracle RAC cluster, perform the steps in the following procedure to remove that node's configuration from the CP server.

---

**Note:** The `cpsadm` command is used to perform the steps in this procedure. For detailed information about the `cpsadm` command, see the *Veritas Storage Foundation for Oracle RAC Administrator's Guide*.

---

**To remove the node configuration from the CP server**

- 1 Log into the CP server as the root user.
- 2 View the list of VCS users on the CP server, using the following command:

```
cpsadm -s cp_server -a list_users
```

Where *cp\_server* is the virtual IP/ virtual hostname of the CP server.

- 3 Remove the VCS user associated with the node you previously removed from the cluster.

For CP server in non-secure mode:

```
cpsadm -s cp_server -a rm_user \
-e cpsclient@sys5 -f cps_operator -g vx
```

- 4 Remove the node entry from the CP server:

```
cpsadm -s cp_server -a rm_node -h sys5 -c clus1 -n 2
```

- 5 View the list of nodes on the CP server to ensure that the node entry was removed:

```
cpsadm -s cp_server -a list_nodes
```

## Removing security credentials from the leaving node

If the leaving node is part of a cluster that is running in a secure mode, you must remove the security credentials from node sys5. Perform the following steps.

**To remove the security credentials**

- 1 Stop the AT process.

```
/opt/VRTSvcs/bin/vcsauth/vcsauthserver/bin/vcsauthserver.sh \
stop
```

- 2 Remove the credentials.

```
rm -rf /var/VRTSvcs/vcsauth/data/
```

## Updating the Storage Foundation for Databases (SFDB) repository after removing a node

After removing a node from a cluster, you do not need to perform any steps to update the SFDB repository.

For information on removing the SFDB repository after removing the product:

See [“Removing the Storage Foundation for Databases \(SFDB\) repository after removing the product”](#) on page 495.

## Sample configuration file for removing a node from the cluster

You may use this sample file as reference information to understand the configuration changes involved when you remove a node from a cluster.

The existing sample configuration before removing the node `sys5` is as follows:

- The existing cluster `clus1` comprises three nodes `sys1`, `sys2`, and `sys5` and hosts a single database.
- The Oracle database is stored on CFS.
- The database is managed by the VCS agent for Oracle. The agent starts, stops, and monitors the database.
- Only one private IP address is configured for Oracle Clusterware. The private IP address is managed by the PrivNIC agent for high availability.
- The Oracle Cluster Registry (OCR) and voting disk are stored on CFS.

---

**Note:** The following sample file shows in **bold** the configuration information that is removed when the node "sys5" is removed from the cluster.

---

```
include "types.cf"
include "CFSTypes.cf"
include "CVMTypes.cf"
include "OracleTypes.cf"
include "PrivNIC.cf"

cluster clus1 (
 UserNames = { admin = bopHo }
```

```
Administrators = { admin }
UseFence = SCSI3
)
```

```
system sys1 (
)
```

```
system sys2 (
)
```

```
system sys5 (
)
```

---

**Note:** In the following group oradb1\_grp, the sys5 node must be removed.

---

```
group oradb1_grp (
 SystemList = { sys1 = 0, sys2 = 1, sys5 = 2 }
 AutoFailOver = 0
 Parallel = 1
 AutoStartList = { sys1, sys2, sys5 }
)
```

---

**Note:** In the following Oracle resource, the sys5 node information must be removed.

---

```
Oracle oral (
 Critical = 0
 Sid @sys1 = vrts1
 Sid @sys2 = vrts2
 Sid @sys5 = vrts3
 Owner = oracle
 Home = "/app/oracle/orahome"
 StartUpOpt = "SRVCTLSTART"
 ShutDownOpt = "SRVCTLSTOP"
)

CFSMount oradata_mnt (
 Critical = 0
 MountPoint = "/oradata"
 BlockDevice = "/dev/vx/dsk/oradatadg/oratavol"
)

CVMVolDg oradata_voldg (
 Critical = 0
```

```

 CVMDiskGroup = oradatadg
 CVMVolume = { oradatavol }
 CVMActivation = sw
)

requires group cvm online local firm
oral requires oradata_mnt
oradata_mnt requires oradata_voldg

```

---

**Note:** In the following CVM and CVMCluster resources, the sys5 node information must be removed.

---

```

group cvm (
 SystemList = { sys1 = 0, sys2 = 1, sys5 =2 }
 AutoFailOver = 0
 Parallel = 1
 AutoStartList = { sys1, sys2, sys5 }
)

Application cssd (
 Critical = 0
 StartProgram = "/opt/VRTSvcs/rac/bin/cssd-online"
 StopProgram = "/opt/VRTSvcs/rac/bin/cssd-offline"
 CleanProgram = "/opt/VRTSvcs/rac/bin/cssd-clean"
 MonitorProgram = "/opt/VRTSvcs/rac/bin/cssd-monitor"
 OnlineRetryLimit = 20
)

CFSMount ocrvote_mnt (
 Critical = 0
 MountPoint = "/ocrvote"
 BlockDevice = "/dev/vx/dsk/ocrvotedg/ocrvotevol"
 MountOpt= "mincache=direct"
)

CVMVolDg ocrvote_voldg (
 Critical = 0
 CVMDiskGroup = ocrvotedg
 CVMVolume = { ocrvotevol }
 CVMActivation = sw
)

```

```
CFSfsckd vxfsckd (
)

CVMCluster cvm_clus (
 CVMClustName = clus1
 CVMNodeId = { sys1 = 0, sys2 = 1, sys5 =2 }
 CVMTransport = gab
 CVMTimeout = 200
)

CVMVxconfigd cvm_vxconfigd (
 Critical = 0
 CVMVxconfigdArgs = { syslog }
)
```

---

**Note:** In the following PrivNIC resource, the sys5 node information must be removed.

---

```
PrivNIC ora_priv (
 Critical = 0
 Device@sys1 = { lan1 = 0, lan2 = 1 }
 Device@sys2 = { lan1 = 0, lan2 = 1 }
 Device@sys5 = { lan1 = 0, lan2 = 1 }
 Address@sys1 = "192.168.12.1"
 Address@sys2 = "192.168.12.2"
 Address@sys5 = "192.168.12.5"
 NetMask = "255.255.255.0"
)
```

```
cssd requires ocrvote_mnt
cssd requires ora_priv
ocrvote_mnt requires ocrvote_voldg
ocrvote_mnt requires vxfsckd
ocrvote_voldg requires cvm_clus
vxfsckd requires cvm_clus
cvm_clus requires cvm_vxconfigd
```



# Configuration of disaster recovery environments

- [Chapter 31. Configuring disaster recovery environments](#)

# Configuring disaster recovery environments

This chapter includes the following topics:

- [Disaster recovery options for SF Oracle RAC](#)
- [About setting up a campus cluster for disaster recovery](#)
- [About setting up a global cluster environment for SF Oracle RAC](#)
- [About configuring a parallel global cluster using Veritas Volume Replicator \(VVR\) for replication](#)

## Disaster recovery options for SF Oracle RAC

SF Oracle RAC supports configuring a disaster recovery environment using:

- Campus cluster
- Global clustering option (GCO) with replication
- Global clustering using Veritas Volume Replicator (VVR) for replication

For more about planning for disaster recovery environments:

See [“About global clusters”](#) on page 29.

See [“About Veritas Volume Replicator”](#) on page 30.

See [“About campus clusters”](#) on page 29.

See [“Supported replication technologies for global clusters”](#) on page 47.

You can install and configure clusters for your disaster recovery environment as you would for any cluster using the procedures in this installation guide.

For a high level description of the tasks for implementing disaster recovery environments:

See [“About setting up a campus cluster for disaster recovery”](#) on page 475.

See [“About setting up a global cluster environment for SF Oracle RAC”](#) on page 477.

See [“About configuring a parallel global cluster using Veritas Volume Replicator \(VVR\) for replication”](#) on page 478.

For complete details for configuring your disaster recovery environment once clusters are installed and configured:

See the *Veritas Storage Foundation and High Availability Solutions Disaster Recovery Implementation Guide*.

## About setting up a campus cluster for disaster recovery

Campus clusters:

- Are connected using a high speed cable that guarantees network access between the nodes
- Provide local high availability and disaster recovery functionality in a single cluster
- Employ shared disk groups mirrored across sites with Veritas Volume Manager (VxVM)
- Are supported by Veritas Storage Foundation for Oracle RAC (SF Oracle RAC)

The following high-level tasks illustrate the setup steps for a parallel campus cluster in an SF for Oracle RAC environment.

**Table 31-1** Tasks for setting up a parallel campus cluster for disaster recovery

| Task                                                            | Description                                                                                                         |
|-----------------------------------------------------------------|---------------------------------------------------------------------------------------------------------------------|
| Prepare to set up campus cluster configuration                  | See the <i>Veritas Storage Foundation and High Availability Solutions Disaster Recovery Implementations Guide</i> . |
| Configure I/O fencing to prevent data corruption                | See the <i>Veritas Storage Foundation and High Availability Solutions Disaster Recovery Implementations Guide</i> . |
| Prepare to install Oracle RAC Clusterware and database binaries | See the <i>Veritas Storage Foundation for Oracle RAC Installation and Configuration Guide</i> .                     |

**Table 31-1** Tasks for setting up a parallel campus cluster for disaster recovery  
*(continued)*

| Task                                                            | Description                                                                                                                                                           |
|-----------------------------------------------------------------|-----------------------------------------------------------------------------------------------------------------------------------------------------------------------|
| Prepare to install Oracle RAC Clusterware and database binaries | See <a href="#">“About preparing to install Oracle RAC”</a> on page 241.                                                                                              |
| Configure VxVM disk groups for campus cluster                   | See the <i>Veritas Storage Foundation and High Availability Solutions Disaster Recovery Implementations Guide</i> .                                                   |
| Install Oracle RAC Clusterware and database binaries            | For Oracle RAC, see the <i>Veritas Storage Foundation for Oracle RAC Installation and Configuration Guide</i> .<br><br>For SFCFS HA, see your database documentation. |
| Install Oracle RAC Clusterware and database binaries            | See <a href="#">“About installing Oracle RAC”</a> on page 299.                                                                                                        |
| Configure VCS service groups                                    | See the <i>Veritas Storage Foundation and High Availability Solutions Disaster Recovery Implementations Guide</i> .                                                   |

Figure 31-1 Sample SF Oracle RAC configuration

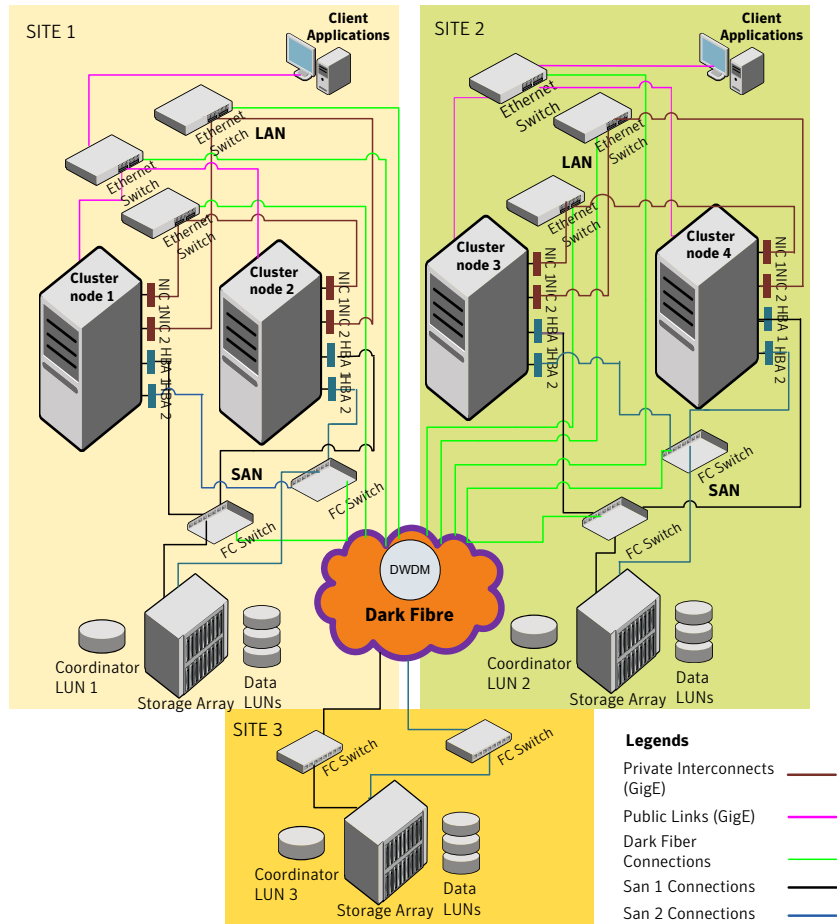

Although a Coordination Point (CP) server is not used in the current example, it can also be used instead of a third site for a coordinator disk.

## About setting up a global cluster environment for SF Oracle RAC

Configuring a global cluster for environment with parallel clusters requires the coordination of many component setup tasks. The procedures provided here are guidelines. You will need this guide to install and configure SF Oracle RAC on each

cluster. Refer to the *Veritas Storage Foundation and High Availability Solutions Disaster Recovery Guide* to configure a global cluster environment and replication between the two clusters.

- Configure a SF Oracle RAC cluster at the primary site
- Configure an SF Oracle RAC cluster at the secondary site
- Configure a global cluster environment
- Test the HA/DR configuration

Upon successful testing, you can bring the environment into production

For global cluster configuration details:

See the *Veritas Storage Foundation and High Availability Solutions Disaster Recovery Guide*.

## About configuring a parallel global cluster using Veritas Volume Replicator (VVR) for replication

Configuring a global cluster for environment with SF Oracle RAC and Veritas Volume Replicator requires the coordination of many component setup tasks. The tasks listed below are guidelines.

Before configuring two clusters for global clustering, you must verify that:

- You have the correct installation options enabled for SF Oracle RAC, whether you are using keyless licensing or installing keys manually. You must have the GCO option for a global cluster and VVR enabled.  
Review SF Oracle RAC requirements and licensing information.
- Both clusters have SF Oracle RAC software installed and configured.

---

**Note:** You can install and configure both clusters at the same time, or you can configure the second cluster at a later time than the first.

---

You can use this guide to install and configure SF Oracle RAC on each cluster. For details for configuring a global cluster environment and replication between the the clusters using VVR:

See the *Veritas Storage Foundation and High Availability Solutions Disaster Recovery Implementation Guide*.

With two clusters installed and configured , you are ready to configure a global cluster environment using VVR. You must perform the following tasks to modify both cluster configurations to support replication in the global cluster environment.

**Table 31-2** Tasks for configuring a parallel global cluster with VVR

| Task                                                       | Description                                                                                                                                                                                                                                                                                                                                                                                                                                                                                                                                 |
|------------------------------------------------------------|---------------------------------------------------------------------------------------------------------------------------------------------------------------------------------------------------------------------------------------------------------------------------------------------------------------------------------------------------------------------------------------------------------------------------------------------------------------------------------------------------------------------------------------------|
| Setting up replication on the primary site                 | <ul style="list-style-type: none"> <li>■ Create the Storage Replicator Log (SRL) in the disk group for the database.</li> <li>■ Create the Replicated Volume Group (RVG) on the primary site.</li> </ul>                                                                                                                                                                                                                                                                                                                                    |
| Setting up replication on the secondary site               | <ul style="list-style-type: none"> <li>■ Create a disk group to hold the data volume, SRL, and RVG on the storage on the secondary site. You must match the names and sizes of these volumes with the names and sizes of the volumes on the primary site.</li> <li>■ Edit the /etc/vx/vras/.rdg file on the secondary site.</li> <li>■ Use resolvable virtual IP addresses that set network RLINK connections as host names of the primary and secondary sites.</li> <li>■ Create the replication objects on the secondary site.</li> </ul> |
| Starting replication of the database.                      | <p>You can use either of the following methods to start replication:</p> <ul style="list-style-type: none"> <li>■ Automatic synchronization</li> <li>■ Full synchronization with Storage Checkpoint</li> </ul>                                                                                                                                                                                                                                                                                                                              |
| Configuring VCS for replication on clusters at both sites. | <p>Configure Veritas Cluster Server (VCS) to provide high availability for the database:</p> <ul style="list-style-type: none"> <li>■ Modify the VCS configuration on the primary site</li> <li>■ Modify the VCS configuration on the secondary site</li> </ul>                                                                                                                                                                                                                                                                             |

Once the global clusters and replication with VVR are configured, the following replication use cases are supported for it:

- Migration of the role of the primary site to the remote site
- Takeover of the primary site role by the secondary site
- Migrate the role of primary site to the secondary site
- Migrate the role of new primary site back to the original primary site
- Take over after an outage
- Resynchronize after an outage
- Update the rlink to reflect changes

For details on the replication use cases:

See the *Veritas Storage Foundation and High Availability Solutions Disaster Recovery Implementation Guide*.



# Uninstallation of SF Oracle RAC

- [Chapter 32. Preparing to uninstall SF Oracle RAC from a cluster](#)
- [Chapter 33. Uninstalling SF Oracle RAC using the product installer](#)
- [Chapter 34. Performing an automated uninstallation of SF Oracle RAC using response files](#)

# Preparing to uninstall SF Oracle RAC from a cluster

This chapter includes the following topics:

- [About uninstalling SF Oracle RAC from a cluster](#)
- [Options for uninstalling SF Oracle RAC](#)
- [Preparing to uninstall SF Oracle RAC from a cluster](#)

## About uninstalling SF Oracle RAC from a cluster

You can uninstall SF Oracle RAC using the `uninstallsrac`.

---

**Note:** After you uninstall SF Oracle RAC, you cannot access the Oracle database as Veritas Volume Manager and Veritas File System are uninstalled from the cluster. Make sure that you back up the Oracle database before you uninstall SF Oracle RAC.

---

[Figure 32-1](#) illustrates the steps that are required to uninstall SF Oracle RAC from a cluster.

**Figure 32-1** SF Oracle RAC uninstallation

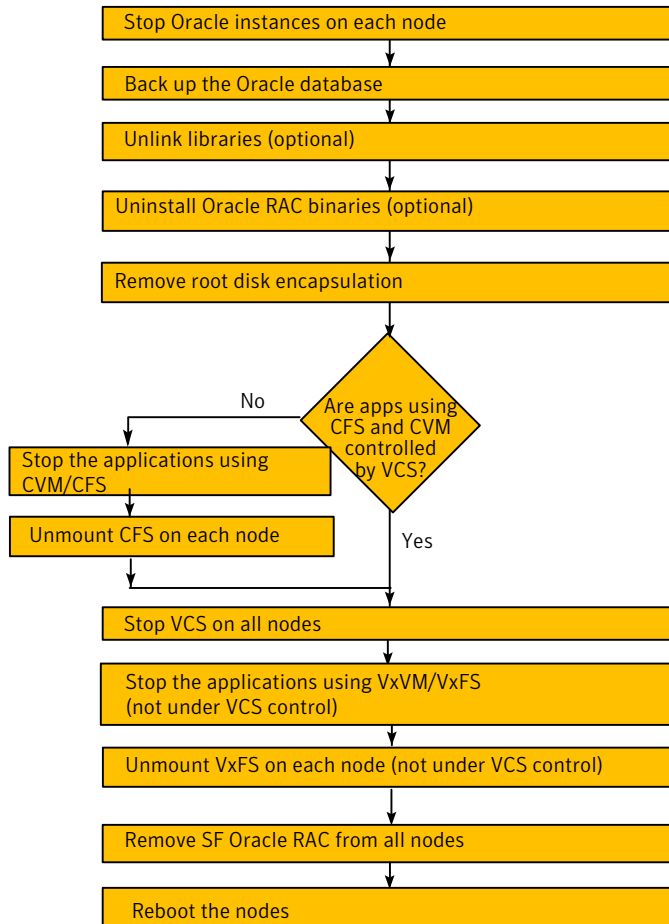

## Options for uninstalling SF Oracle RAC

Table 32-1 lists the available options for uninstalling SF Oracle RAC:

**Table 32-1** Options for uninstalling SF Oracle RAC

| Options                              | Description                                                |
|--------------------------------------|------------------------------------------------------------|
| SF Oracle RAC uninstallation program | Use the uninstallsfrac program to uninstall SF Oracle RAC. |

**Table 32-1** Options for uninstalling SF Oracle RAC (*continued*)

| Options       | Description                                                                                                                                                                        |
|---------------|------------------------------------------------------------------------------------------------------------------------------------------------------------------------------------|
| Response file | Use a response file to automate or perform an unattended installation of SF Oracle RAC.<br><br>See <a href="#">“Uninstalling SF Oracle RAC using a response file”</a> on page 497. |

## Preparing to uninstall SF Oracle RAC from a cluster

Perform the steps in the following procedure before you uninstall SF Oracle RAC from a cluster.

### To prepare to uninstall SF Oracle RAC from a cluster

- 1 Stop Oracle instances.  
See [“Stopping Oracle instances”](#) on page 485.
- 2 Back up the Oracle database.  
See [“Backing up the Oracle database”](#) on page 486.
- 3 Unlink the SF Oracle RAC libraries from Oracle RAC libraries (optional).  
See [“Unlinking the SF Oracle RAC libraries from Oracle RAC”](#) on page 486.
- 4 Uninstalling Oracle RAC (optional)  
See [“Uninstalling Oracle RAC \(optional\)”](#) on page 487.
- 5 Stop the applications that use CFS (outside of VCS control).  
See [“Stopping the applications that use CVM or CFS \(outside of VCS control\)”](#) on page 487.
- 6 Unmount CFS file systems (outside of VCS control).  
See [“Unmounting CFS file systems \(outside of VCS control\)”](#) on page 488.
- 7 Stop VCS.  
See [“Stopping VCS”](#) on page 488.
- 8 Stop the applications that use VxFS (outside of VCS control).  
See [“Stopping the applications that use VxVM or VxFS \(outside of VCS control\)”](#) on page 489.

- 9 Unmount VxFS file systems (outside of VCS control).  
 See [“Unmounting VxFS file systems \(outside of VCS control\)”](#) on page 489.
- 10 Stop the AMF driver.

## Stopping Oracle instances

You need to stop Oracle Clusterware and the Oracle instances on the cluster nodes where you want to uninstall SF Oracle RAC. Before you stop the Oracle instances, stop the applications that are dependent on the service groups that contain Oracle.

The procedure in this section provides instructions to stop the instances on a two-node cluster; the nodes are `sys1` and `sys2`. Depending on the VCS configuration, the procedure to stop Oracle instances may vary.

### To stop Oracle instances

- 1 Log in as the superuser on one of the nodes in the cluster.
- 2 On each node, take the Oracle resources in the VCS configuration file (`main.cf`) offline.

```
hagrpl -offline oracle_group -sys node_name
```

For example:

```
hagrpl -offline oral -sys sys1
```

```
hagrpl -offline oral -sys sys2
```

These commands stop the Oracle resources under VCS control.

If the database is not managed by VCS, stop the Oracle database as follows:

```
$ srvctl stop database -d db_name
```

- 3 Verify that the state of the Oracle (if the database is managed by VCS) and CVM service groups are offline and online respectively.

```
hagrpl -state
```

| Group | Attribute | System | Value   |
|-------|-----------|--------|---------|
| oral  | State     | sys1   | OFFLINE |
| oral  | State     | sys2   | OFFLINE |
| cvm   | State     | sys1   | ONLINE  |
| cvm   | State     | sys2   | ONLINE  |

## Backing up the Oracle database

If you plan to retain the Oracle database, you must back up the Oracle database.

For instructions on backing up the Oracle database, see the Oracle documentation.

## Unlinking the SF Oracle RAC libraries from Oracle RAC

If you want to reuse the Oracle RAC binaries, unlink the SF Oracle RAC libraries from Oracle RAC.

---

**Note:** The Oracle RAC binaries that are located on Veritas File System will not be accessible after the uninstallation.

---

### To unlink the SF Oracle RAC libraries from Oracle RAC libraries

- 1 Stop Oracle's Clusterware:

```
hares -offline cssd_resname -sys node_name
```

- 2 Unlink the Veritas VCSMM library.

Perform this step on each node if the Oracle libraries are on local storage. If the Oracle libraries are installed on shared storage, perform the step on one node only.

For Oracle RAC 10g Release 2:

```
$ cd $CRS_HOME/lib
```

For Oracle RAC 11g Release 2:

```
$ cd $GRID_HOME/lib
```

For Oracle RAC 10g Release 2 (HP-UX (IA) architectures):

```
$ ln -sf $CRS_HOME/lib/libskgxns.so libskgxns2.so
```

Oracle RAC 11g Release 2 (HP-UX (IA) architectures):

```
$ ln -sf $GRID_HOME/lib/libskgxns.so libskgxns2.so
```

### 3 For Oracle RAC 10g: Unlink the Veritas VCS IPC library.

Perform this step on each node if the Oracle libraries are on local storage. If the Oracle libraries are installed on shared storage, perform the step on one node only.

```
$ cd $ORACLE_HOME/lib
$ make -f ins_rdbms.mk rac_on
$ make -f ins_rdbms.mk ioracle
```

### 4 Unlink the Veritas ODM library.

Perform this step on each node if the Oracle libraries are on local storage. If the Oracle libraries are installed on shared storage, perform the step on one node only.

```
$ cd $ORACLE_HOME/lib
```

For Oracle RAC 10g (HP-UX (IA) architecture):

```
$ ln -sf $ORACLE_HOME/lib/libodmd10.so libodm10.so
```

For Oracle RAC 11g Release 2 (HP-UX (IA) architecture):

```
$ ln -sf $ORACLE_HOME/lib/libodmd11.so libodm11.so
```

## Uninstalling Oracle RAC (optional)

You cannot use the Oracle database after you uninstall SF Oracle RAC. However, you can continue using the Oracle RAC software, provided the Oracle Clusterware and database binaries are not installed on Veritas file system. To continue using Oracle RAC, unlink the SF Oracle RAC libraries from Oracle RAC as described in the preceding topic.

For instructions on uninstalling Oracle RAC, see the Oracle documentation.

## Stopping the applications that use CVM or CFS (outside of VCS control)

You need to stop the applications that use CVM volumes or CFS mount points not controlled by VCS.

### To stop the applications that use CVM or CFS (outside of VCS control)

- 1 Using native application commands, stop the applications that use CVM or a CFS.
- 2 Verify that no processes use the CFS mount point:

```
fuser -c mount_point
```

## Unmounting CFS file systems (outside of VCS control)

You need to unmount CFS file systems that are not under VCS control on all nodes.

### To unmount CFS file systems not under VCS control

- 1 Determine the file systems that need to be unmounted by checking the output of the mount command. The command lists all the mounted clustered file systems. Consult the main.cf file for identifying the files that are under VCS control.

```
mount -v | grep vxfs | grep cluster
```

- 2 Unmount each file system that is not controlled by VCS:

```
umount mount_point
```

## Stopping VCS

Stop VCS to take the service groups on all nodes offline.

The process also stops replication as the replication service group is also taken offline.



### To stop VCS

- 1 Log in as the superuser on one of the cluster nodes.
- 2 Stop VCS on all nodes:

```
hastop -all
```

- 3 Verify the output of the `gabconfig -a` command to ensure that VCS has been stopped.

In this command output, the VCS engine or high availability daemon (HAD) port `h` is not displayed. This output indicates that VCS has been stopped.

```
gabconfig -a
```

```
GAB Port Memberships
```

```
=====
Port a gen 5c3d0b membership 01
Port b gen 5c3d10 membership 01
Port d gen 5c3d0c membership 01
Port o gen 5c3d0f membership 01
```

## Stopping the applications that use VxVM or VxFS (outside of VCS control)

You need to stop all applications that use VxVM volumes or VxFS mount points not under VCS control.

### To stop the applications that use VxVM or VxFS (outside of VCS control)

- 1 Using native application commands, stop the applications that use VxVM or VxFS.
- 2 Verify that no processes use the VxFS mount point:

```
fuser -c mount_point
```

## Unmounting VxFS file systems (outside of VCS control)

You need to unmount VxFS file systems that are not under VCS control on all nodes.

---

**Note:** To avoid issues on rebooting, you must remove all entries of VxFS from the `/etc/fstab` file.

---

### To unmount VxFS file systems not under VCS control

- 1 Determine the file systems that need to be unmounted by checking the output of the mount command. The command lists all the mounted file systems.

```
mount -v | grep vxfs
```

- 2 Unmount each file system that is not under VCS control:

```
umount mount_point
```

# Uninstalling SF Oracle RAC using the product installer

This chapter includes the following topics:

- [Uninstalling SF Oracle RAC with the script-based installer](#)
- [Uninstalling SF Oracle RAC with the Veritas Web-based installer](#)
- [Removing other configuration files \(optional\)](#)
- [Removing the Storage Foundation for Databases \(SFDB\) repository after removing the product](#)

## Uninstalling SF Oracle RAC with the script-based installer

Perform the steps in the following procedure to remove SF Oracle RAC from a cluster.

### To remove SF Oracle RAC from a cluster

- 1 Remove the CP server configuration using the removal script.  
For instructions, see the *Veritas Cluster Server Installation Guide*.
- 2 Remove the SF Oracle RAC depots. You can remove the depots using the uninstallation program or using the response file.

Using the uninstallation program:

See [“Removing the SF Oracle RAC depots”](#) on page 492.

Using the response file:

See [“Uninstalling SF Oracle RAC using a response file”](#) on page 497.

- 3 Remove other configuration files (optional).  
See [“Removing other configuration files \(optional\)”](#) on page 494.
- 4 Remove the Storage Foundation for Databases (SFDB) repository after removing the product.  
See [“Removing the Storage Foundation for Databases \(SFDB\) repository after removing the product”](#) on page 495.
- 5 Reboot the nodes.

```
shutdown -r now
```

## Removing the SF Oracle RAC depots

The `uninstallsfrac` can remove these depots only if the root disk is not under VxVM control and there are no open volumes.

The installer performs the following tasks:

- Removes the SF Oracle RAC depots.
- Removes the language depots, if installed.

---

**Note:** The following directories remain after uninstallation: `/opt/VRTS`, `/opt/VRTSperl`, `/etc/VRTSvcs`, `/var/VRTSvcs`, `/var/VRTSat_lhc`, `/var/VRTSat`. They contain logs and configuration information for future reference. You may or may not remove them.

---

### To remove the SF Oracle RAC depots

- 1 Log in as the superuser on any node in the cluster.
- 2 Navigate to the directory that contains the `uninstallsfrac`:

```
cd /opt/VRTS/install
```

- 3 Start the `uninstallsfrac`:

```
./uninstallsfrac<version> sys1 sys2
```

Where `<version>` is the specific release version.

See [“About the Veritas installer”](#) on page 77.

The program displays the directory where the logs are created and the copyright message.

- 4 If you have VxVM installed, indicate whether or not you want to remove the VxVM depots from all nodes in the cluster. Enter **y** only if the root disk is outside of VxVM control.

The `uninstallsrac` performs the following tasks:

- Checks the operating system on each node
- Verifies the system-to-system communication
- Verifies the licenses
- Checks for the SF Oracle RAC depots installed on the nodes. This process involves identifying system uninstallation requirements and dependencies between depots to determine the safety and order of uninstalling depots.

- 5 Confirm to uninstall SF Oracle RAC.

```
All SF Oracle RAC processes that are currently running
must be stopped.
```

```
Do you want to stop SF Oracle RAC processes now?
```

```
[y,n,q,?] (y) y
```

---

**Note:** If you have not already unmounted the VxFS file systems, the installer will display a message asking that the file systems be unmounted. Make sure that you unmount the file systems before you proceed.

---

The program performs the following tasks:

- Stops the agents and performs verifications on each node to proceed with uninstallation
- Stops the SF Oracle RAC processes and uninstalls the SF Oracle RAC depots
- Displays the location of the uninstallation summary, response file, and log files for reference.

## Uninstalling SF Oracle RAC with the Veritas Web-based installer

This section describes how to uninstall using the Veritas Web-based installer.

---

**Note:** After you uninstall the product, you cannot access any file systems you created using the default disk layout Version in SF Oracle RAC 6.0.1 with a previous version of SF Oracle RAC.

---

### To uninstall SF Oracle RAC

- 1 Perform the required steps to save any data that you wish to preserve. For example, take back-ups of configuration files.
- 2 Start the Web-based installer.  
See [“Starting the Veritas Web-based installer”](#) on page 122.
- 3 On the Select a task and a product page, select **Uninstall a Product** from the Task drop-down list.
- 4 Select **Veritas Storage Foundation for Oracle RAC** from the Product drop-down list, and click **Next**.
- 5 Indicate the systems on which to uninstall. Enter one or more system names, separated by spaces. Click **Next**.
- 6 After the validation completes successfully, click **Next** to uninstall SF Oracle RAC on the selected system.
- 7 If there are any processes running on the target system, the installer stops the processes. Click **Next**.
- 8 After the installer stops the processes, the installer removes the products from the specified system.  
Click **Next**.
- 9 After the uninstall completes, the installer displays the location of the summary, response, and log files. If required, view the files to confirm the status of the removal.
- 10 Click **Finish**.  
Most depots have kernel components. In order to ensure their complete removal, a system reboot is recommended after all the depots have been removed.

## Removing other configuration files (optional)

You may want to remove the following configuration files that remain after you run the `uninstallsfrac`:

```
/etc/vcsmmtab
/etc/vxfentab
/etc/vxfendg
/etc/llttab
/etc/gabtab
/etc/llthosts
```

To remove the configuration files:

```
rm /etc/vcsmmtab
rm /etc/vxfentab
rm /etc/vxfendg
rm /etc/llttab
rm /etc/gabtab
rm /etc/llthosts
```

## Removing the Storage Foundation for Databases (SFDB) repository after removing the product

After removing the product, you can remove the SFDB repository file and any backups.

Removing the SFDB repository file disables the SFDB tools.

### To remove the SFDB repository

- 1 Identify the SFDB repositories created on the host.

```
cat /var/vx/vxdba/rep_loc
```

Oracle:

```
{
 "sfae_rept_version" : 1,
 "oracle" : {
 "SFAEDB" : {
 "location" : "/data/sfaedb/.sfae",
 "old_location" : "",
 "alias" : [
 "sfaedb"
]
 }
 }
}
```

- 2 Remove the directory identified by the `location` key.

Oracle:

```
rm -rf /data/sfaedb/.sfae
```

- 3 Remove the repository location file.

```
rm -rf /var/vx/vxdba/rep_loc
```

This completes the removal of the SFDB repository.



# Performing an automated uninstalation of SF Oracle RAC using response files

This chapter includes the following topics:

- [Uninstalling SF Oracle RAC using a response file](#)
- [Response file variables to uninstall Veritas Storage Foundation for Oracle RAC](#)
- [Sample response file for uninstalling SF Oracle RAC](#)

## Uninstalling SF Oracle RAC using a response file

Perform the steps in the following procedure to uninstall SF Oracle RAC using a response file.

**To uninstall SF Oracle RAC using a response file**

- 1 Make sure that you have completed the pre-uninstallation tasks.

- 2 Create a response file using one of the available options.

For information on various options available for creating a response file:

See [“About response files”](#) on page 353.

---

**Note:** You must replace the host names in the response file with that of the systems from which you want to uninstall SF Oracle RAC.

---

For a sample response file:

See [“Sample response file for uninstalling SF Oracle RAC”](#) on page 499.

- 3 Navigate to the directory containing the SF Oracle RAC uninstallation program:

```
cd /opt/VRTS/install
```

- 4 Start the uninstallation:

```
./uninstallsfrac<version> -responsefile /tmp/response_file
```

Where *<version>* is the specific release version.

See [“About the Veritas installer”](#) on page 77.

Where */tmp/response\_file* is the full path name of the response file.

- 5 Remove other Veritas configuration files and depots that may be present.

- 6 Reboot the nodes:

```
shutdown -r now
```

- 7 Optionally, remove residual configuration files, if any.

See [“Removing other configuration files \(optional\)”](#) on page 494.

## Response file variables to uninstall Veritas Storage Foundation for Oracle RAC

[Table 34-1](#) lists the response file variables that you can define to configure SF Oracle RAC.

**Table 34-1** Response file variables for uninstalling SF Oracle RAC

| Variable            | Description                                                                                                                                                                                                                                 |
|---------------------|---------------------------------------------------------------------------------------------------------------------------------------------------------------------------------------------------------------------------------------------|
| CFG{systems}        | List of systems on which the product is to be installed or uninstalled.<br><br>List or scalar: list<br><br>Optional or required: required                                                                                                   |
| CFG{prod}           | Defines the product to be installed or uninstalled.<br><br>List or scalar: scalar<br><br>Optional or required: required                                                                                                                     |
| CFG{opt}{keyfile}   | Defines the location of an ssh keyfile that is used to communicate with all remote systems.<br><br>List or scalar: scalar<br><br>Optional or required: optional                                                                             |
| CFG{opt}{tmppath}   | Defines the location where a working directory is created to store temporary files and the depots that are needed during the install. The default location is /var/tmp.<br><br>List or scalar: scalar<br><br>Optional or required: optional |
| CFG{opt}{logpath}   | Mentions the location where the log files are to be copied. The default location is /opt/VRTS/install/logs.<br><br>List or scalar: scalar<br><br>Optional or required: optional                                                             |
| CFG{opt}{uninstall} | Uninstalls SF Oracle RAC depots.<br><br>List or scalar: scalar<br><br>Optional or required: optional                                                                                                                                        |

## Sample response file for uninstalling SF Oracle RAC

The following sample response file uninstalls SF Oracle RAC from nodes, sys1 and sys2.

```
our %CFG;

$CFG{opt}{uninstall}=1;
$CFG{prod}="SFRAC601";
```

```
$CFG{systems}=[qw(sys1 sys2)];
```

```
1;
```

# Installation reference

- [Appendix A. Installation scripts](#)
- [Appendix B. Tunable files for installation](#)
- [Appendix C. Sample installation and configuration values](#)
- [Appendix D. Sample configuration files](#)
- [Appendix E. Setting up inter-system communication](#)
- [Appendix F. Automatic Storage Management](#)
- [Appendix G. Creating a test database](#)
- [Appendix H. High availability agent information](#)
- [Appendix I. SF Oracle RAC deployment scenarios](#)
- [Appendix J. Compatibility issues when installing Veritas Storage Foundation for Oracle RAC with other products](#)

# Installation scripts

This appendix includes the following topics:

- [Installation script options](#)
- [About using the postcheck option](#)

## Installation script options

[Table A-1](#) shows command line options for the installation script. For an initial install or upgrade, options are not usually required. The installation script options apply to all Veritas Storage Foundation product scripts, except where otherwise noted.

See [“About the Veritas installer”](#) on page 77.

**Table A-1** Available command line options

| Commandline Option | Function                                                                                                                                                                                                                                                     |
|--------------------|--------------------------------------------------------------------------------------------------------------------------------------------------------------------------------------------------------------------------------------------------------------|
| -addnode           | Adds a node to a high availability cluster.                                                                                                                                                                                                                  |
| -allpkgs           | Displays all depots required for the specified product. The depots are listed in correct installation order. The output can be used to create scripts for command line installs, or for installations over a network.                                        |
| -comcleanup        | The <code>-comcleanup</code> option removes the secure shell or remote shell configuration added by installer on the systems. The option is only required when installation routines that performed auto-configuration of the shell are abruptly terminated. |

**Table A-1** Available command line options (*continued*)

| Commandline Option                 | Function                                                                                                                                                                                                        |
|------------------------------------|-----------------------------------------------------------------------------------------------------------------------------------------------------------------------------------------------------------------|
| -configcps                         | The <code>-configcps</code> option is used to configure CP server on a running system or cluster.                                                                                                               |
| -configure                         | Configures the product after installation.                                                                                                                                                                      |
| -fencing                           | Configures I/O fencing in a running cluster.                                                                                                                                                                    |
| -fips                              | The <code>-fips</code> option is used to enable or disable security with fips mode on a running VCS cluster. It could only be used together with <code>-security</code> or <code>-securityonnode</code> option. |
| -ignite                            | The <code>-ignite</code> option allows you to create SD bundles for a product. When you create the SD bundle for the product, the Veritas product disc must be mounted on the Ignite-UX Server.                 |
| -hostfile <i>full_path_to_file</i> | Specifies the location of a file that contains a list of hostnames on which to install.                                                                                                                         |
| -installallpkgs                    | The <code>-installallpkgs</code> option is used to select all depots.                                                                                                                                           |
| -installrecpkgs                    | The <code>-installrecpkgs</code> option is used to select the recommended depots set.                                                                                                                           |
| -installminpkgs                    | The <code>-installminpkgs</code> option is used to select the minimum depots set.                                                                                                                               |
| -ignorepatchreqs                   | The <code>-ignorepatchreqs</code> option is used to allow installation or upgrading even if the prerequisite packages or patches are missed on the system.                                                      |
| -keyfile <i>ssh_key_file</i>       | Specifies a key file for secure shell (SSH) installs. This option passes <code>-i ssh_key_file</code> to every SSH invocation.                                                                                  |
| -license                           | Registers or updates product licenses on the specified systems.                                                                                                                                                 |
| -logpath <i>log_path</i>           | Specifies a directory other than <code>/opt/VRTS/install/logs</code> as the location where installer log files, summary files, and response files are saved.                                                    |

**Table A-1** Available command line options (*continued*)

| Commandline Option           | Function                                                                                                                                                                                                                                                                                       |
|------------------------------|------------------------------------------------------------------------------------------------------------------------------------------------------------------------------------------------------------------------------------------------------------------------------------------------|
| -makeresponsefile            | Use the <code>-makeresponsefile</code> option only to generate response files. No actual software installation occurs when you use this option.                                                                                                                                                |
| -minpkgs                     | Displays the minimal depots required for the specified product. The depots are listed in correct installation order. Optional depots are not listed. The output can be used to create scripts for command line installs, or for installations over a network. See <code>allpkgs</code> option. |
| -nolic                       | Allows installation of product depots without entering a license key. Licensed features cannot be configured, started, or used when this option is specified.                                                                                                                                  |
| -pkginfo                     | Displays a list of depots and the order of installation in a human-readable format. This option only applies to the individual product installation scripts. For example, use the <code>-pkginfo</code> option with the <code>installvcs</code> script to display VCS depots.                  |
| -pkgpath <i>package_path</i> | Designates the path of a directory that contains all depots to install. The directory is typically an NFS-mounted location and must be accessible by all specified installation systems.                                                                                                       |
| -pkgset                      | Discovers and displays the depot group (minimum, recommended, all) and depots that are installed on the specified systems.                                                                                                                                                                     |
| -pkgtable                    | Displays product's depots in correct installation order by group.                                                                                                                                                                                                                              |
| -postcheck                   | Checks for different HA and file system-related processes, the availability of different ports, and the availability of cluster-related service groups.                                                                                                                                        |
| -precheck                    | Performs a preinstallation check to determine if systems meet all installation requirements. Symantec recommends doing a precheck before installing a product.                                                                                                                                 |



**Table A-1** Available command line options (*continued*)

| Commandline Option                 | Function                                                                                                                                                                                                                                                                                                                                   |
|------------------------------------|--------------------------------------------------------------------------------------------------------------------------------------------------------------------------------------------------------------------------------------------------------------------------------------------------------------------------------------------|
| -recpkgs                           | Displays the recommended depots required for the specified product. The depots are listed in correct installation order. Optional depots are not listed. The output can be used to create scripts for command line installs, or for installations over a network. See <code>allpkgs</code> option.                                         |
| -redirect                          | Displays progress details without showing the progress bar.                                                                                                                                                                                                                                                                                |
| -requirements                      | The <code>-requirements</code> option displays required OS version, required depots and patches, file system space, and other system requirements in order to install the product.                                                                                                                                                         |
| -responsefile <i>response_file</i> | Automates installation and configuration by using system and configuration information stored in a specified file instead of prompting for information. The <i>response_file</i> must be a full path name. You must edit the response file to use it for subsequent installations. Variable field definitions are defined within the file. |
| -rolling_upgrade                   | Starts a rolling upgrade. Using this option, the installer detects the rolling upgrade status on cluster systems automatically without the need to specify rolling upgrade phase 1 or phase 2 explicitly.                                                                                                                                  |
| -rollingupgrade_phase1             | The <code>-rollingupgrade_phase1</code> option is used to perform rolling upgrade Phase-I. In the phase, the product kernel depots get upgraded to the latest version.                                                                                                                                                                     |
| -rollingupgrade_phase2             | The <code>-rollingupgrade_phase2</code> option is used to perform rolling upgrade Phase-II. In the phase, VCS and other agent depots upgrade to the latest version. Product kernel drivers are rolling-upgraded to the latest protocol version.                                                                                            |
| -rsh                               | Specify this option when you want to use RSH and RCP for communication between systems instead of the default SSH and SCP.                                                                                                                                                                                                                 |

**Table A-1** Available command line options (*continued*)

| Commandline Option       | Function                                                                                                                                                                                                                                                                                                                                                                                                            |
|--------------------------|---------------------------------------------------------------------------------------------------------------------------------------------------------------------------------------------------------------------------------------------------------------------------------------------------------------------------------------------------------------------------------------------------------------------|
| -security                | The <code>-security</code> option is used to convert a running VCS cluster between secure and non-secure modes of operation.                                                                                                                                                                                                                                                                                        |
| -securityonenode         | The <code>-securityonenode</code> option is used to configure a secure cluster node by node.                                                                                                                                                                                                                                                                                                                        |
| -securitytrust           | The <code>-securitytrust</code> option is used to setup trust with another broker.                                                                                                                                                                                                                                                                                                                                  |
| -serial                  | Specifies that the installation script performs install, uninstall, start, and stop operations on each system in a serial fashion. If this option is not specified, these operations are performed simultaneously on all systems.                                                                                                                                                                                   |
| -setunables              | Specify this option when you want to set tunable parameters after you install and configure a product. You may need to restart processes of the product for the tunable parameter values to take effect. You must use this option together with the <code>-tunablesfile</code> option.                                                                                                                              |
| -start                   | Starts the daemons and processes for the specified product.                                                                                                                                                                                                                                                                                                                                                         |
| -stop                    | Stops the daemons and processes for the specified product.                                                                                                                                                                                                                                                                                                                                                          |
| -timeout                 | The <code>-timeout</code> option is used to specify the number of seconds that the script should wait for each command to complete before timing out. Setting the <code>-timeout</code> option overrides the default value of 1200 seconds. Setting the <code>-timeout</code> option to 0 prevents the script from timing out. The <code>-timeout</code> option does not work with the <code>-serial</code> option. |
| -tmppath <i>tmp_path</i> | Specifies a directory other than <code>/var/tmp</code> as the working directory for the installation scripts. This destination is where initial logging is performed and where depots are copied on remote systems before installation.                                                                                                                                                                             |

**Table A-1** Available command line options (*continued*)

| Commandline Option                  | Function                                                                                                                                                                                                                                                                                                                                                                                                |
|-------------------------------------|---------------------------------------------------------------------------------------------------------------------------------------------------------------------------------------------------------------------------------------------------------------------------------------------------------------------------------------------------------------------------------------------------------|
| -tunables                           | Lists all supported tunables and create a tunables file template.                                                                                                                                                                                                                                                                                                                                       |
| -tunables_file <i>tunables_file</i> | Specify this option when you specify a tunables file. The tunables file should include tunable parameters.                                                                                                                                                                                                                                                                                              |
| -upgrade                            | Specifies that an existing version of the product exists and you plan to upgrade it.                                                                                                                                                                                                                                                                                                                    |
| -upgrade_kernelpkgs                 | The <code>-upgrade_kernelpkgs</code> option has been renamed to <code>-rollingupgrade_phase1</code> .                                                                                                                                                                                                                                                                                                   |
| -upgrade_nonkernelpkgs              | The <code>-upgrade_nonkernelpkgs</code> option has been renamed to <code>-rollingupgrade_phase2</code> .                                                                                                                                                                                                                                                                                                |
| -version                            | Checks and reports the installed products and their versions. Identifies the installed and missing depots and patches where applicable for the product. Provides a summary that includes the count of the installed and any missing depots and patches where applicable. Lists the installed patches, hotfixes, and available updates for the installed product if an Internet connection is available. |

## About using the postcheck option

You can use the installer's post-check to determine installation-related problems and to aid in troubleshooting.

---

**Note:** This command option requires downtime for the node.

---

When you use the `postcheck` option, it can help you troubleshoot the following VCS-related issues:

- The heartbeat link does not exist.
- The heartbeat link cannot communicate.
- The heartbeat link is a part of a bonded or aggregated NIC.
- A duplicated cluster ID exists (if LLT is not running at the check time).
- The VRTSllt pkg version is not consistent on the nodes.

- The `llt-linkinstall` value is incorrect.
- The `llthosts(4)` or `llttab(4)` configuration is incorrect.
- the `/etc/gabtab` file is incorrect.
- The incorrect GAB `linkinstall` value exists.
- The `VRTSgab` pkg version is not consistent on the nodes.
- The `main.cf` file or the `types.cf` file is invalid.
- The `/etc/VRTSvcs/conf/sysname` file is not consistent with the hostname.
- The cluster UUID does not exist.
- The `uuidconfig.pl` file is missing.
- The `VRTSvcs` pkg version is not consistent on the nodes.
- The `/etc/vxfenmode` file is missing or incorrect.
- The `/etc/vxfendg` file is invalid.
- The `vxfen` link-install value is incorrect.
- The `VRTSvxfen` pkg version is not consistent.

The `postcheck` option can help you troubleshoot the following SFHA or SFCFSHA issues:

- Volume Manager cannot start because the `/etc/vx/reconfig.d/state.d/install-db` file has not been removed.
- Volume Manager cannot start because the `volboot` file is not loaded.
- Volume Manager cannot start because no license exists.
- Cluster Volume Manager cannot start because the CVM configuration is incorrect in the `main.cf` file. For example, the `Autostartlist` value is missing on the nodes.
- Cluster Volume Manager cannot come online because the node ID in the `/etc/llthosts` file is not consistent.
- Cluster Volume Manager cannot come online because `Vxfen` is not started.
- Cluster Volume Manager cannot start because `gab` is not configured.
- Cluster Volume Manager cannot come online because of a CVM protocol mismatch.
- Cluster Volume Manager group name has changed from "cvm", which causes CVM to go offline.

You can use the installer's post-check option to perform the following checks:

General checks for all products:

- All the required depots are installed.
- The versions of the required depots are correct.
- There are no verification issues for the required depots.

#### Checks for Volume Manager (VM):

- Lists the daemons which are not running (`vxattachd`, `vxconfigbackupd`, `vxesd`, `vxrelocd` ...).
- Lists the disks which are not in 'online' or 'online shared' state (`vxdisk list`).
- Lists the diskgroups which are not in 'enabled' state (`vxdg list`).
- Lists the volumes which are not in 'enabled' state (`vxprint -g <dgname>`).
- Lists the volumes which are in 'Unstartable' state (`vxinfo -g <dgname>`).
- Lists the volumes which are not configured in (AIX) `/etc/filesystems`, (Linux/HP-UX) `/etc/fstab`, or (SunOS) `/etc/vfstab`.

#### Checks for File System (FS):

- Lists the VxFS kernel modules which are not loaded (`vxfs/fdd/vxportal`).
- Whether all VxFS file systems present in (AIX) `/etc/filesystems`, (Linux/HP-UX) `/etc/fstab`, or (SunOS) `/etc/vfstab` file are mounted.
- Whether all VxFS file systems present in (AIX) `/etc/filesystems`, (Linux/HP-UX) `/etc/fstab`, or (SunOS) `/etc/vfstab` are in disk layout 6 or higher.
- Whether all mounted VxFS file systems are in disk layout 6 or higher.

#### Checks for Cluster File System:

- Whether FS and ODM are running at the latest protocol level.
- Whether all mounted CFS file systems are managed by VCS.
- Whether `cvm` service group is online.

See [“Performing a postcheck on a node”](#) on page 143.

# Tunable files for installation

This appendix includes the following topics:

- [About setting tunable parameters using the installer or a response file](#)
- [Setting tunables for an installation, configuration, or upgrade](#)
- [Setting tunables with no other installer-related operations](#)
- [Setting tunables with an un-integrated response file](#)
- [Preparing the tunables file](#)
- [Setting parameters for the tunables file](#)
- [Tunables value parameter definitions](#)

## About setting tunable parameters using the installer or a response file

You can set non-default product and system tunable parameters using a tunables file. With the file, you can set tunables such as the I/O policy or toggle native multi-pathing. The tunables file passes arguments to the installer script to set tunables. With the file, you can set the tunables for the following operations:

- When you install, configure, or upgrade systems.

```
./installer -tunablesfile tunables_file_name
```

See “[Setting tunables for an installation, configuration, or upgrade](#)” on page 511.

- When you apply the tunables file with no other installer-related operations.

```
./installer -tunablesfile tunables_file_name -setttunables [
system1 system2 ...]
```

See [“Setting tunables with no other installer-related operations”](#) on page 512.

- When you apply the tunables file with an un-integrated response file.

```
./installer -responsefile response_file_name -tunablesfile
tunables_file_name
```

See [“Setting tunables with an un-integrated response file”](#) on page 513.

For more information on response files, see the *chapter: About response files*.

You must select the tunables that you want to use from this guide.

See [“Tunables value parameter definitions”](#) on page 515.

## Setting tunables for an installation, configuration, or upgrade

You can use a tunables file for installation procedures to set non-default tunables. You invoke the installation script with the `tunablesfile` option. The tunables file passes arguments to the script to set the selected tunables. You must select the tunables that you want to use from this guide.

See [“Tunables value parameter definitions”](#) on page 515.

---

**Note:** Certain tunables only take effect after a system reboot.

---

### To set the non-default tunables for an installation, configuration, or upgrade

- 1 Prepare the tunables file.  
See [“Preparing the tunables file”](#) on page 514.
- 2 Make sure the systems where you want to install SF Oracle RAC meet the installation requirements.
- 3 Complete any preinstallation tasks.
- 4 Copy the tunables file to one of the systems where you want to install, configure, or upgrade the product.
- 5 Mount the product disc and navigate to the directory that contains the installation program.
- 6 Start the installer for the installation, configuration, or upgrade. For example:

```
./installer -tunablesfile /tmp/tunables_file
```

Where `/tmp/tunables_file` is the full path name for the tunables file.

- 7 Proceed with the operation. When prompted, accept the tunable parameters.  
Certain tunables are only activated after a reboot. Review the output carefully to determine if the system requires a reboot to set the tunable value.
- 8 The installer validates the tunables. If an error occurs, exit the installer and check the tunables file.

## Setting tunables with no other installer-related operations

You can use the installer to set tunable parameters without any other installer-related operations. You must use the parameters described in this guide. Note that many of the parameters are product-specific. You must select the tunables that you want to use from this guide.

See [“Tunables value parameter definitions”](#) on page 515.

---

**Note:** Certain tunables only take effect after a system reboot.

---

### To set tunables with no other installer-related operations

- 1 Prepare the tunables file.  
See [“Preparing the tunables file”](#) on page 514.
- 2 Make sure the systems where you want to install SF Oracle RAC meet the installation requirements.
- 3 Complete any preinstallation tasks.
- 4 Copy the tunables file to one of the systems that you want to tune.
- 5 Mount the product disc and navigate to the directory that contains the installation program.
- 6 Start the installer with the `-setttunables` option.

```
./installer -tunablesfile tunables_file_name -setttunables [
sys123 sys234 ...]
```

Where `/tmp/tunables_file` is the full path name for the tunables file.



- 7 Proceed with the operation. When prompted, accept the tunable parameters.  
Certain tunables are only activated after a reboot. Review the output carefully to determine if the system requires a reboot to set the tunable value.
- 8 The installer validates the tunables. If an error occurs, exit the installer and check the tunables file.

## Setting tunables with an un-integrated response file

You can use the installer to set tunable parameters with an un-integrated response file. You must use the parameters described in this guide. Note that many of the parameters are product-specific. You must select the tunables that you want to use from this guide.

See [“Tunables value parameter definitions”](#) on page 515.

---

**Note:** Certain tunables only take effect after a system reboot.

---

### To set tunables with an un-integrated response file

- 1 Make sure the systems where you want to install SF Oracle RAC meet the installation requirements.
- 2 Complete any preinstallation tasks.
- 3 Prepare the tunables file.  
See [“Preparing the tunables file”](#) on page 514.
- 4 Copy the tunables file to one of the systems that you want to tune.
- 5 Mount the product disc and navigate to the directory that contains the installation program.
- 6 Start the installer with the `-responsefile` and `-tunablesfile` options.

```
./installer -responsefile response_file_name -tunablesfile
tunables_file_name
```

Where *response\_file\_name* is the full path name for the response file and *tunables\_file\_name* is the full path name for the tunables file.

- 7 Certain tunables are only activated after a reboot. Review the output carefully to determine if the system requires a reboot to set the tunable value.
- 8 The installer validates the tunables. If an error occurs, exit the installer and check the tunables file.

For more information on response files, see the *chapter: About response files*.

## Preparing the tunables file

A tunables file is a Perl module and consists of an opening and closing statement, with the tunables defined between. Use the hash symbol at the beginning of the line to comment out the line. The tunables file opens with the line "our %TUN;" and ends with the return true "1;" line. The final return true line only needs to appear once at the end of the file. Define each tunable parameter on its own line.

You can use the installer to create a tunables file template, or manually format tunables files you create.

### To create a tunables file template

- ◆ Start the installer with the `-tunables` option. Enter the following:

```
./installer -tunables
```

You see a list of all supported tunables, and the location of the tunables file template.

### To manually format tunables files

- ◆ Format the tunable parameter as follows:

```
$TUN{"tunable_name"}{"system_name"|"*"}=value_of_tunable;
```

For the *system\_name*, use the name of the system, its IP address, or a wildcard symbol. The *value\_of\_tunable* depends on the type of tunable you are setting. End the line with a semicolon.

The following is an example of a tunables file.

```

Tunable Parameter Values:

our %TUN;

$TUN{"tunable1"}{"*"}=1024;
$TUN{"tunable3"}{"sys123"}="SHA256";

1;
```

## Setting parameters for the tunables file

Each tunables file defines different tunable parameters. The values that you can use are listed in the description of each parameter. Select the tunables that you want to add to the tunables file and then configure each parameter.

See [“Tunables value parameter definitions”](#) on page 515.

Each line for the parameter value starts with \$TUN. The name of the tunable is in curly brackets and double-quotes. The system name is enclosed in curly brackets and double-quotes. Finally define the value and end the line with a semicolon, for example:

```
$TUN{"dmp_daemon_count"}{"node123"}=16;
```

In this example, you are changing the dmp\_daemon\_count value from its default of 10 to 16. You can use the wildcard symbol "\*" for all systems. For example:

```
$TUN{"dmp_daemon_count"}{"*"}=16;
```

## Tunables value parameter definitions

When you create a tunables file for the installer you can only use the parameters in the following list.

Prior to making any updates to the tunables, refer to the *Veritas Storage Foundation and High Availability Solutions Tuning Guide* for detailed information on product tunable ranges and recommendations .

[Table B-1](#) describes the supported tunable parameters that can be specified in a tunables file.

**Table B-1** Supported tunable parameters

| Tunable             | Description                                                                                                                                                                                        |
|---------------------|----------------------------------------------------------------------------------------------------------------------------------------------------------------------------------------------------|
| dmp_cache_open      | (Veritas Dynamic Multi-Pathing) Whether the first open on a device performed by an array support library (ASL) is cached. This tunable must be set after Veritas Dynamic Multi-Pathing is started. |
| dmp_daemon_count    | (Veritas Dynamic Multi-Pathing) The number of kernel threads for DMP administrative tasks. This tunable must be set after Veritas Dynamic Multi-Pathing is started.                                |
| dmp_delayq_interval | (Veritas Dynamic Multi-Pathing) The time interval for which DMP delays the error processing if the device is busy. This tunable must be set after Veritas Dynamic Multi-Pathing is started.        |
| dmp_evm_handling    | (Veritas Dynamic Multi-Pathing) Whether EVM should be handled or not.                                                                                                                              |

**Table B-1** Supported tunable parameters (*continued*)

| Tunable               | Description                                                                                                                                                                                                       |
|-----------------------|-------------------------------------------------------------------------------------------------------------------------------------------------------------------------------------------------------------------|
| dmp_fast_recovery     | (Veritas Dynamic Multi-Pathing) Whether DMP should attempt to obtain SCSI error information directly from the HBA interface. This tunable must be set after Veritas Dynamic Multi-Pathing is started.             |
| dmp_health_time       | (Veritas Dynamic Multi-Pathing) The time in seconds for which a path must stay healthy. This tunable must be set after Veritas Dynamic Multi-Pathing is started.                                                  |
| dmp_log_level         | (Veritas Dynamic Multi-Pathing) The level of detail to which DMP console messages are displayed. This tunable must be set after Veritas Dynamic Multi-Pathing is started.                                         |
| dmp_low_impact_probe  | (Veritas Dynamic Multi-Pathing) Whether the low impact path probing feature is enabled. This tunable must be set after Veritas Dynamic Multi-Pathing is started.                                                  |
| dmp_lun_retry_timeout | (Veritas Dynamic Multi-Pathing) The retry period for handling transient errors. This tunable must be set after Veritas Dynamic Multi-Pathing is started.                                                          |
| dmp_monitor_fabric    | (Veritas Dynamic Multi-Pathing) Whether the Event Source daemon (vxesd) uses the Storage Networking Industry Association (SNIA) HBA API. This tunable must be set after Veritas Dynamic Multi-Pathing is started. |
| dmp_monitor_osevent   | (Veritas Dynamic Multi-Pathing) Whether the Event Source daemon (vxesd) monitors operating system events. This tunable must be set after Veritas Dynamic Multi-Pathing is started.                                |
| dmp_monitor_ownership | (Veritas Dynamic Multi-Pathing) Whether the dynamic change in LUN ownership is monitored. This tunable must be set after Veritas Dynamic Multi-Pathing is started.                                                |
| dmp_native_support    | (Veritas Dynamic Multi-Pathing) Whether DMP does multi-pathing for native devices. This tunable must be set after Veritas Dynamic Multi-Pathing is started.                                                       |
| dmp_path_age          | (Veritas Dynamic Multi-Pathing) The time for which an intermittently failing path needs to be monitored before DMP marks it as healthy. This tunable must be set after Veritas Dynamic Multi-Pathing is started.  |

**Table B-1** Supported tunable parameters (*continued*)

| Tunable                   | Description                                                                                                                                                                                                                         |
|---------------------------|-------------------------------------------------------------------------------------------------------------------------------------------------------------------------------------------------------------------------------------|
| dmp_pathswitch_blks_shift | (Veritas Dynamic Multi-Pathing) The default number of contiguous I/O blocks sent along a DMP path to an array before switching to the next available path. This tunable must be set after Veritas Dynamic Multi-Pathing is started. |
| dmp_probe_idle_lun        | (Veritas Dynamic Multi-Pathing) Whether the path restoration kernel thread probes idle LUNs. This tunable must be set after Veritas Dynamic Multi-Pathing is started.                                                               |
| dmp_probe_threshold       | (Veritas Dynamic Multi-Pathing) The number of paths will be probed by the restore daemon. This tunable must be set after Veritas Dynamic Multi-Pathing is started.                                                                  |
| dmp_restore_cycles        | (Veritas Dynamic Multi-Pathing) The number of cycles between running the check_all policy when the restore policy is check_periodic. This tunable must be set after Veritas Dynamic Multi-Pathing is started.                       |
| dmp_restore_interval      | (Veritas Dynamic Multi-Pathing) The time interval in seconds the restore daemon analyzes the condition of paths. This tunable must be set after Veritas Dynamic Multi-Pathing is started.                                           |
| dmp_restore_policy        | (Veritas Dynamic Multi-Pathing) The policy used by DMP path restoration thread. This tunable must be set after Veritas Dynamic Multi-Pathing is started.                                                                            |
| dmp_restore_state         | (Veritas Dynamic Multi-Pathing) Whether kernel thread for DMP path restoration is started. This tunable must be set after Veritas Dynamic Multi-Pathing is started.                                                                 |
| dmp_retry_count           | (Veritas Dynamic Multi-Pathing) The number of times a path reports a path busy error consecutively before DMP marks the path as failed. This tunable must be set after Veritas Dynamic Multi-Pathing is started.                    |
| dmp_scsi_timeout          | (Veritas Dynamic Multi-Pathing) The timeout value for any SCSI command sent via DMP. This tunable must be set after Veritas Dynamic Multi-Pathing is started.                                                                       |
| dmp_sfg_threshold         | (Veritas Dynamic Multi-Pathing) The status of the subpaths failover group (SFG) feature. This tunable must be set after Veritas Dynamic Multi-Pathing is started.                                                                   |

**Table B-1** Supported tunable parameters (*continued*)

| Tunable             | Description                                                                                                                                                                                                                                                                                                                                                           |
|---------------------|-----------------------------------------------------------------------------------------------------------------------------------------------------------------------------------------------------------------------------------------------------------------------------------------------------------------------------------------------------------------------|
| dmp_stat_interval   | (Veritas Dynamic Multi-Pathing) The time interval between gathering DMP statistics. This tunable must be set after Veritas Dynamic Multi-Pathing is started.                                                                                                                                                                                                          |
| max_diskq           | (Veritas File System) Specifies the maximum disk queue generated by a single file. The installer sets only the system default value of max_diskq. Refer to the tuneftab(4) manual page for setting this tunable for a specified block device.                                                                                                                         |
| read_ahead          | (Veritas File System) The 0 value disables read ahead functionality, the 1 value (default) retains traditional sequential read ahead behavior, and the 2 value enables enhanced read ahead for all reads. The installer sets only the system default value of read_ahead. Refer to the tuneftab(4) manual page for setting this tunable for a specified block device. |
| read_nstream        | (Veritas File System) The number of parallel read requests of size read_pref_io that can be outstanding at one time. The installer sets only the system default value of read_nstream. Refer to the tuneftab(4) manual page for setting this tunable for a specified block device.                                                                                    |
| read_pref_io        | (Veritas File System) The preferred read request size. The installer sets only the system default value of read_pref_io. Refer to the tuneftab(4) manual page for setting this tunable for a specified block device.                                                                                                                                                  |
| vol_cmpres_enabled  | (Veritas Volume Manager) Allow enabling compression for VERITAS Volume Replicator.                                                                                                                                                                                                                                                                                    |
| vol_cmpres_threads  | (Veritas Volume Manager) Maximum number of compression threads for VERITAS Volume Replicator.                                                                                                                                                                                                                                                                         |
| vol_default_iodelay | (Veritas Volume Manager) Time to pause between I/O requests from VxVM utilities (10ms units). This tunable requires system reboot to take effect.                                                                                                                                                                                                                     |
| vol_fmr_logsz       | (Veritas Volume Manager) Maximum size of bitmap Fast Mirror Resync uses to track changed blocks (KBytes). This tunable requires system reboot to take effect.                                                                                                                                                                                                         |

**Table B-1** Supported tunable parameters (*continued*)

| Tunable                | Description                                                                                                                                          |
|------------------------|------------------------------------------------------------------------------------------------------------------------------------------------------|
| vol_max_adminio_poolsz | (Veritas Volume Manager) Maximum amount of memory used by VxVM admin I/O's (bytes). This tunable requires system reboot to take effect.              |
| vol_max_nmpool_sz      | (Veritas Volume Manager) Maximum name pool size (bytes).                                                                                             |
| vol_max_rdback_sz      | (Veritas Volume Manager) Storage Record readback pool maximum (bytes).                                                                               |
| vol_max_wrspool_sz     | (Veritas Volume Manager) Maximum memory used in clustered version of VERITAS Volume Replicator (bytes).                                              |
| vol_maxio              | (Veritas Volume Manager) Maximum size of logical VxVM I/O operations (sectors). This tunable requires system reboot to take effect.                  |
| vol_maxioctl           | (Veritas Volume Manager) Maximum size of data passed into the VxVM ioctl calls (bytes). This tunable requires system reboot to take effect.          |
| vol_maxparallelio      | (Veritas Volume Manager) Number of I/O operations vxconfigd can request at one time. This tunable requires system reboot to take effect.             |
| vol_maxspecialio       | (Veritas Volume Manager) Maximum size of a VxVM I/O operation issued by an ioctl call (sectors). This tunable requires system reboot to take effect. |
| vol_min_lowmem_sz      | (Veritas Volume Manager) Low water mark for memory (bytes).                                                                                          |
| vol_nm_hb_timeout      | (Veritas Volume Manager) Veritas Volume Replicator timeout value (ticks).                                                                            |
| vol_rvio_maxpool_sz    | (Veritas Volume Manager) Maximum memory requested by VERITAS Volume Replicator (bytes).                                                              |
| vol_stats_enable       | (Veritas Volume Manager) Enable VxVM I/O stat collection.                                                                                            |
| vol_subdisk_num        | (Veritas Volume Manager) Maximum number of subdisks attached to a single VxVM plex. This tunable requires system reboot to take effect.              |

**Table B-1** Supported tunable parameters (*continued*)

| Tunable                     | Description                                                                                                                                               |
|-----------------------------|-----------------------------------------------------------------------------------------------------------------------------------------------------------|
| voldrl_max_drtregs          | (Veritas Volume Manager) Maximum number of dirty VxVM regions that can exist on a non-sequential DRL. This tunable requires system reboot to take effect. |
| voldrl_max_seq_dirty        | (Veritas Volume Manager) Maximum number of dirty regions in sequential mode. This tunable requires system reboot to take effect.                          |
| voldrl_min_regionsz         | (Veritas Volume Manager) Minimum size of a VxVM Dirty Region Logging (DRL) region (sectors). This tunable requires system reboot to take effect.          |
| voldrl_volumemax_drtregs    | (Veritas Volume Manager) Max per volume dirty regions in log-plex DRL.                                                                                    |
| voldrl_volumemax_drtregs_20 | (Veritas Volume Manager) Max per volume dirty regions in DCO version 20.                                                                                  |
| voldrl_dirty_regions        | (Veritas Volume Manager) Number of regions cached for DCO version 30.                                                                                     |
| voliomem_chunk_size         | (Veritas Volume Manager) Size of VxVM memory allocation requests (bytes). This tunable requires system reboot to take effect.                             |
| voliomem_maxpool_sz         | (Veritas Volume Manager) Maximum amount of memory used by VxVM (bytes). This tunable requires system reboot to take effect.                               |
| voliot_errbuf_dflt          | (Veritas Volume Manager) Size of a VxVM error trace buffer (bytes). This tunable requires system reboot to take effect.                                   |
| voliot_iobuf_limit          | (Veritas Volume Manager) Maximum total size of all VxVM I/O trace buffers (bytes). This tunable requires system reboot to take effect.                    |
| voliot_iobuf_max            | (Veritas Volume Manager) Maximum size of a VxVM I/O trace buffer (bytes). This tunable requires system reboot to take effect.                             |
| voliot_max_open             | (Veritas Volume Manager) Maximum number of VxVM trace channels available for vxtrace commands. This tunable requires system reboot to take effect.        |



**Table B-1** Supported tunable parameters (*continued*)

| Tunable              | Description                                                                                                                                                                                                                                                                            |
|----------------------|----------------------------------------------------------------------------------------------------------------------------------------------------------------------------------------------------------------------------------------------------------------------------------------|
| volpagemod_max_memsz | (Veritas Volume Manager) Maximum paging module memory used by Instant Snapshots (Kbytes).                                                                                                                                                                                              |
| volraid_rsrtransmax  | (Veritas Volume Manager) Maximum number of VxVM RAID-5 transient reconstruct operations in parallel. This tunable requires system reboot to take effect.                                                                                                                               |
| vxfs_ninode          | (Veritas File System) Number of entries in the VxFS inode table. This tunable requires system reboot to take effect.                                                                                                                                                                   |
| write_nstream        | (Veritas File System) The number of parallel write requests of size write_pref_io that can be outstanding at one time. The installer sets only the system default value of write_nstream. Refer to the tunefstab(4) manual page for setting this tunable for a specified block device. |
| write_pref_io        | (Veritas File System) The preferred write request size. The installer sets only the system default value of write_pref_io. Refer to the tunefstab(4) manual page for setting this tunable for a specified block device.                                                                |

# Sample installation and configuration values

This appendix includes the following topics:

- [About the installation and configuration worksheets](#)
- [SF Oracle RAC worksheet](#)
- [Oracle RAC worksheet](#)
- [Replicated cluster using VVR worksheet](#)
- [Replicated cluster using SRDF worksheet](#)
- [Required installation information for Oracle Clusterware/Grid Infrastructure](#)
- [Required installation information for Oracle database](#)

## About the installation and configuration worksheets

The installation programs prompt you for information during the installation and configuration of SF Oracle RAC and Oracle RAC. The installation and configuration worksheets provide sample values that you can use as examples of the information required when you run the Veritas installation programs or the Oracle Universal Installer.

Symantec recommends using the worksheets to record values for your systems before you begin the installation and configuration process.

# SF Oracle RAC worksheet

This section provides worksheets for installing and configuring SF Oracle RAC, its component products, and features.

[Table C-1](#) contains the sample values that may be used when you install and configure SF Oracle RAC. Enter the SF Oracle RAC values for your systems in the following table:

**Table C-1** SF Oracle RAC worksheet

| Installation information             | Sample value                                                                                                                                                                                                                                                                                                                                                                                                                                                             | Assigned value |
|--------------------------------------|--------------------------------------------------------------------------------------------------------------------------------------------------------------------------------------------------------------------------------------------------------------------------------------------------------------------------------------------------------------------------------------------------------------------------------------------------------------------------|----------------|
| Number of nodes in the cluster       | 2                                                                                                                                                                                                                                                                                                                                                                                                                                                                        |                |
| Host names for Primary cluster       | sys1 and sys2<br><b>Note:</b> Do not use the underscore character in host names. Host names that use the underscore character are not compliant with RFC standards and cause issues.                                                                                                                                                                                                                                                                                     |                |
| Host names for added or removed node | sys5<br><b>Note:</b> Do not use the underscore character in host names. Host names that use the underscore character are not compliant with RFC standards and cause issues.                                                                                                                                                                                                                                                                                              |                |
| License keys                         | License keys can be one of the following types: <ul style="list-style-type: none"><li>Valid license keys for each system in the cluster</li><li>Valid site license key</li><li>Valid demo license key</li></ul> If you want to configure global clusters and enable disaster recovery, you must enter appropriate license keys.<br><b>Note:</b> You can choose between SF Oracle RAC and SF Oracle RAC Disaster Recovery and High Availability options for license keys. |                |

**Table C-1** SF Oracle RAC worksheet (*continued*)

| Installation information                                                  | Sample value                                                                                                                                                      | Assigned value |
|---------------------------------------------------------------------------|-------------------------------------------------------------------------------------------------------------------------------------------------------------------|----------------|
| SF Oracle RAC depots to be installed on the cluster                       | Install only the required depots if you do not want to configure any optional components or features.<br><br>Default option is to install the recommended depots. |                |
| Primary cluster name                                                      | clus1                                                                                                                                                             |                |
| Primary cluster ID number                                                 | 101                                                                                                                                                               |                |
| Private network links                                                     | lan1, lan2                                                                                                                                                        |                |
| Cluster Manager NIC (Primary NIC)                                         | lan0                                                                                                                                                              |                |
| Cluster Manager IP                                                        | 10.10.12.1, 10.10.12.2                                                                                                                                            |                |
| Netmask for the virtual IP address                                        | 255.255.240.0                                                                                                                                                     |                |
| VCS user name (not required if you configure your cluster in secure mode) | VCS usernames must not exceed 1024 characters.<br><br>Example: smith                                                                                              |                |
| VCS user password                                                         | VCS passwords must not exceed 512 characters.                                                                                                                     |                |
| VCS user privileges                                                       | Users have three levels of privileges: A=Administrator, O=Operator, or G=Guest.<br><br>Example: A                                                                 |                |
| Domain-based address of SMTP server                                       | smtp.symantecexample.com                                                                                                                                          |                |
| Email address of SMTP notification recipients                             | admin@symantecexample.com                                                                                                                                         |                |

**Table C-1** SF Oracle RAC worksheet (*continued*)

| Installation information                               | Sample value                                                                                                                                                                                                                                                                                                                                                                                                                                                                                                                        | Assigned value |
|--------------------------------------------------------|-------------------------------------------------------------------------------------------------------------------------------------------------------------------------------------------------------------------------------------------------------------------------------------------------------------------------------------------------------------------------------------------------------------------------------------------------------------------------------------------------------------------------------------|----------------|
| Minimum severity of events for SMTP email notification | <p>Events have four levels of severity:</p> <ul style="list-style-type: none"> <li>■ I=Information</li> <li>■ W=Warning</li> <li>■ E=Error</li> <li>■ S=SevereError</li> </ul> <p>Example: I</p> <p>The severity levels are defined as follows:</p> <ul style="list-style-type: none"> <li>■ Information - Important events that exhibit normal behavior</li> <li>■ Warning - Deviation from normal behavior</li> <li>■ Error - A fault</li> <li>■ Severe Error -Critical error that can lead to data loss or corruption</li> </ul> |                |
| SNMP trap daemon port number the console               | 162                                                                                                                                                                                                                                                                                                                                                                                                                                                                                                                                 |                |
| System name for the SNMP console                       | system2                                                                                                                                                                                                                                                                                                                                                                                                                                                                                                                             |                |
| Minimum severity of events for SNMP trap notification  | <p>Events have four levels of severity:</p> <ul style="list-style-type: none"> <li>■ I=Information</li> <li>■ W=Warning</li> <li>■ E=Error</li> <li>■ S=SevereError</li> </ul> <p>Example: I</p> <p>The severity levels are defined as follows:</p> <ul style="list-style-type: none"> <li>■ Information - Important events that exhibit normal behavior</li> <li>■ Warning - Deviation from normal behavior</li> <li>■ Error - A fault</li> <li>■ Severe Error -Critical error that can lead to data loss or corruption</li> </ul> |                |

**Table C-1** SF Oracle RAC worksheet (*continued*)

| Installation information                                                                                             | Sample value           | Assigned value |
|----------------------------------------------------------------------------------------------------------------------|------------------------|----------------|
| Vxfen disks<br><br>These values are required if SCSI-3 disks are used as coordination points for your configuration. | disk01, disk02, disk03 |                |
| Vxfen disk group                                                                                                     | vxfencoordg            |                |

## Veritas Cluster Server component information

[Table C-2](#) displays the information that is required to configure the Veritas Cluster Server component.

**Table C-2** Veritas Cluster Server component information

| Information                      | Example                                                                                                                                                                                       | Assigned values |
|----------------------------------|-----------------------------------------------------------------------------------------------------------------------------------------------------------------------------------------------|-----------------|
| Name of the cluster              | The name must begin with a letter of the alphabet (a-z, A-Z) and contain only the characters a through z, A through Z, and 1 through 0, hyphen (-), and underscore (_).<br><br>Example: clus1 |                 |
| Unique ID number for the cluster | Number in the range of 0-65535. Within the site that contains the cluster, each cluster must have a unique ID.<br><br>Example: 101                                                            |                 |

**Table C-2** Veritas Cluster Server component information (*continued*)

| Information                                                                | Example                                                                                                                                                                                                                                                                                                                                                                                                                                                           | Assigned values |
|----------------------------------------------------------------------------|-------------------------------------------------------------------------------------------------------------------------------------------------------------------------------------------------------------------------------------------------------------------------------------------------------------------------------------------------------------------------------------------------------------------------------------------------------------------|-----------------|
| <p>Device names of the NICs used by the private networks among systems</p> | <p>You can choose a network interface card that is not part of any aggregated interface, or you can choose an aggregated interface.</p> <p>The interface names that are associated with each NIC for each network link must be the same on all nodes.</p> <p>For example:</p> <ul style="list-style-type: none"> <li>■ lan1</li> <li>■ lan2</li> </ul> <p>Do not use the network interface card that is used for the public network, which is typically lan0.</p> |                 |

## I/O fencing information

[Table C-3](#) displays the information that is required to configure I/O fencing.

**Table C-3** I/O fencing information

| Information                                                                  | Sample values                                                                                                                                                         | Assigned values |
|------------------------------------------------------------------------------|-----------------------------------------------------------------------------------------------------------------------------------------------------------------------|-----------------|
| <p>The name of three disks that form the coordinator disk group.</p>         | <p>The following are examples of disk names:</p> <ul style="list-style-type: none"> <li>■ c1t1d0</li> <li>■ c2t1d0</li> <li>■ c3t1d0</li> </ul>                       |                 |
| <p>The names for each disk in the coordinator disk group (if using DMP).</p> | <p>The following are examples:</p> <ul style="list-style-type: none"> <li>■ /dev/vx/dmp/c1t1d0</li> <li>■ /dev/vx/dmp/c2t1d0</li> <li>■ /dev/vx/dmp/c3t1d0</li> </ul> |                 |

## Cluster Volume Manager information

[Table C-4](#) displays the information that is required to configure the Cluster Volume Manager.

**Table C-4** Cluster Volume Manager information

| Information                                             | Examples                                                                                                                                                                                                                                | Assigned values |
|---------------------------------------------------------|-----------------------------------------------------------------------------------------------------------------------------------------------------------------------------------------------------------------------------------------|-----------------|
| Do you want to configure enclosure-based naming scheme? | <p>Enter Yes to configure an enclosure-based naming scheme.</p> <p>Enter No to not configure an enclosure-based naming scheme.</p> <p><b>Note:</b> Dynamic Multi-Pathing (DMP) is a prerequisite for enclosure-based naming schemes</p> |                 |

## SF Oracle RAC add user information

[Table C-5](#) displays the information that is required to add VCS users. If you configure SF Oracle RAC cluster in secure mode, you need to add VCS users.

---

**Note:** Adding VCS users is optional.

---

**Table C-5** SF Oracle RAC add user information

| Information   | Examples | Assigned values |
|---------------|----------|-----------------|
| User name     | smith    |                 |
| User password | ****     |                 |



**Table C-5** SF Oracle RAC add user information (*continued*)

| Information    | Examples                                                                                                                                                                                                                                                                                                                                                                                                                                                                                                                                             | Assigned values |
|----------------|------------------------------------------------------------------------------------------------------------------------------------------------------------------------------------------------------------------------------------------------------------------------------------------------------------------------------------------------------------------------------------------------------------------------------------------------------------------------------------------------------------------------------------------------------|-----------------|
| User privilege | <p>Users have three levels of privileges:</p> <ul style="list-style-type: none"> <li>■ A=Administrator</li> <li>■ O=Operator</li> <li>■ G=Guest</li> </ul> <p>Example: A</p> <p>VCS privilege levels include:</p> <ul style="list-style-type: none"> <li>■ Administrators— Can perform all operations, including configuration options on the cluster, service groups, systems, resources, and users.</li> <li>■ Operators—Can perform specific operations on a cluster or a service group.</li> <li>■ Guests—Can view specified objects.</li> </ul> |                 |

## Global cluster information

[Table C-6](#) displays the information that is required to configure global clusters.

---

**Note:** Global clusters are an optional feature that requires a license.

---

**Table C-6** Global cluster information

| Information                   | Example                                                                                                                 | Assigned values |
|-------------------------------|-------------------------------------------------------------------------------------------------------------------------|-----------------|
| Name of the public NIC        | <p>You must specify appropriate values for the NIC when you are prompted.</p> <p>Example: lan0</p>                      |                 |
| Virtual IP address of the NIC | <p>You must specify appropriate values for the virtual IP address when you are prompted.</p> <p>Example: 10.10.12.1</p> |                 |

**Table C-6** Global cluster information (*continued*)

| Information                        | Example                                                                                                               | Assigned values |
|------------------------------------|-----------------------------------------------------------------------------------------------------------------------|-----------------|
| Netmask for the virtual IP address | You must specify appropriate values for the netmask when you are prompted.<br><br>Example: 255.255.255.0              |                 |
| NetworkHosts IP addresses          | You must specify appropriate values for the NetworkHosts IP address when you are prompted.<br><br>Example: 10.10.12.2 |                 |

## Veritas Volume Replicator information

[Table C-7](#) displays the information that is required to configure Veritas Volume Replicator (VVR).

---

**Note:** Configuring Veritas Volume Replicator is optional. Veritas Volume Replicator is an advanced option. Users are prompted for this configuration information only if they have entered a VVR license.

---

**Table C-7** Veritas Volume Replicator information

| Information                                          | Examples                                                                            | Assigned values |
|------------------------------------------------------|-------------------------------------------------------------------------------------|-----------------|
| Frequency of VVR statistics collection.              | Enter a number to represent the frequency in seconds.<br><br>Default is 10 seconds. |                 |
| Number of days to preserve the collected statistics. | Enter a number to represent the number of days.<br><br>Default is 3 days.           |                 |

For additional Veritas Volume Replicator information, see the *Veritas Storage Foundation for Oracle RAC Administrator's Guide*.

## Oracle RAC worksheet

This section provides a worksheet with sample values for installing and configuring Oracle RAC.

**Note:** *Italicized* text in parenthesis indicates the corresponding variable that is used in procedures. When you perform the steps in the procedures, ensure that you replace the variables with the values that are assigned to them in this worksheet.

[Table C-8](#) displays the sample worksheets that may be used as reference when you perform the corresponding tasks.

**Table C-8** Required information for Oracle RAC

| Sample value sheet                     | Go to                                       |
|----------------------------------------|---------------------------------------------|
| Oracle user and group                  | See <a href="#">Table C-9</a> on page 531.  |
| Public IP addresses and host names     | See <a href="#">Table C-10</a> on page 532. |
| PrivNIC and MultiPrivNIC               | See <a href="#">Table C-11</a> on page 533. |
| Oracle RAC home directories            | See <a href="#">Table C-12</a> on page 539. |
| OCR and voting disk                    | See <a href="#">Table C-13</a> on page 541. |
| CSSD and Oracle database configuration | See <a href="#">Table C-14</a> on page 542. |

[Table C-9](#) displays sample values that may be used when you create Oracle users and groups.

**Table C-9** Sample value sheet - Oracle user and group

| Information                                                 | Sample value                                                                                                                                           | Assigned value |
|-------------------------------------------------------------|--------------------------------------------------------------------------------------------------------------------------------------------------------|----------------|
| Oracle user name<br>( <i>user_name</i> )                    | <ul style="list-style-type: none"> <li>■ For Oracle Clusterware<br/><b>oracle</b></li> <li>■ For Oracle Grid Infrastructure<br/><b>grid</b></li> </ul> |                |
| Oracle user ID<br>( <i>user_id</i> )                        | <b>1000</b>                                                                                                                                            |                |
| Oracle group name -<br>Primary group<br>( <i>grp_name</i> ) | <b>oinstall</b> (for inventory group as primary group)<br><br>Default is oinstall.                                                                     |                |

**Table C-9** Sample value sheet - Oracle user and group (*continued*)

| Information                                                     | Sample value                                                                                                                                                                             | Assigned value |
|-----------------------------------------------------------------|------------------------------------------------------------------------------------------------------------------------------------------------------------------------------------------|----------------|
| Oracle group name -<br>Secondary group<br><i>(grp_name_sec)</i> | <b>dba</b> (for dba group as secondary group)<br>Default is dba.<br><b>Note:</b> You can have an optional secondary group "oper". Review your Oracle guide for details about this group. |                |
| Oracle group ID -<br>Primary group ID<br><i>(grp_id)</i>        | <b>1000</b> (for inventory group as primary group)                                                                                                                                       |                |
| Oracle group ID -<br>Secondary group ID<br><i>(grp_id_sec)</i>  | <b>1001</b> (for dba group as secondary group)                                                                                                                                           |                |
| Oracle user home<br>directory<br><i>(usr_home_ora)</i>          | <b>/home/oracle</b>                                                                                                                                                                      |                |
| Grid user home<br>directory<br><i>(usr_home_grid)</i>           | <b>/home/grid</b>                                                                                                                                                                        |                |

**Table C-10** displays sample values for public IP addresses and host names.

**Table C-10** Sample value sheet - Public IP addresses and host names

| Information                                                                    | Sample value                                                                                                      | Assigned value |
|--------------------------------------------------------------------------------|-------------------------------------------------------------------------------------------------------------------|----------------|
| Name of a node in<br>the cluster<br><i>(node_name1)</i><br><i>(node_name2)</i> | For a two-node cluster:<br><ul style="list-style-type: none"> <li>■ <b>sys1</b></li> <li>■ <b>sys2</b></li> </ul> |                |
| Name of a new node<br>added to the cluster<br><i>(nodenew_name)</i>            | <b>sys5</b>                                                                                                       |                |
| Virtual IP address                                                             | <b>10.10.10.10</b>                                                                                                |                |
| Virtual IP alias                                                               | <b>sys1-vip</b>                                                                                                   |                |

**Table C-10** Sample value sheet - Public IP addresses and host names (*continued*)

| Information                                           | Sample value                                                                                                               | Assigned value |
|-------------------------------------------------------|----------------------------------------------------------------------------------------------------------------------------|----------------|
| SCAN IP addresses (only for Oracle RAC 11g Release 2) | A minimum of three addresses is recommended.<br><br><b>10.10.10.20</b><br><br><b>10.10.10.21</b><br><br><b>10.10.10.22</b> |                |
| SCAN name (only for Oracle RAC 11g Release 2)         | <b>clus1_scan</b>                                                                                                          |                |

Table C-11 displays sample values that may be used when you configure PrivNIC or MultiPrivNIC.

**Table C-11** Sample value sheet - PrivNIC and MultiPrivNIC

| Information                                                                             | Sample value                                                                                                                                                                                                                                                                                                             | Assigned value |
|-----------------------------------------------------------------------------------------|--------------------------------------------------------------------------------------------------------------------------------------------------------------------------------------------------------------------------------------------------------------------------------------------------------------------------|----------------|
| Private IP address for first node in the cluster - PrivNIC ( <i>privnic_ip_node1</i> )  | <b>192.168.12.1</b> (on sys1)<br><br><b>Note:</b> The IP addresses must not contain leading zeroes in any of the octets that comprise the address for example 0X.X.X.X or X0X.X.X, or X.X.0X.X, or X.X.X.0X. Make sure that the private IP addresses have a format as displayed in the above examples for sys1 and sys2. |                |
| Private IP address for second node in the cluster - PrivNIC ( <i>privnic_ip_node2</i> ) | <b>192.168.12.2</b> (on sys2)<br><br><b>Note:</b> The IP addresses must not contain leading zeroes in any of the octets that comprise the address for example 0X.X.X.X or X0X.X.X, or X.X.0X.X, or X.X.X.0X. Make sure that the private IP addresses have a format as displayed in the above examples for sys1 and sys2. |                |

**Table C-11** Sample value sheet - PrivNIC and MultiPrivNIC (*continued*)

| Information                                                                                        | Sample value                                                                                                                                                                                                                                                                                                                                                                                                                                                                                                                                                                                                                                                                                                                                                                                                                                                                                                                                                                    | Assigned value |
|----------------------------------------------------------------------------------------------------|---------------------------------------------------------------------------------------------------------------------------------------------------------------------------------------------------------------------------------------------------------------------------------------------------------------------------------------------------------------------------------------------------------------------------------------------------------------------------------------------------------------------------------------------------------------------------------------------------------------------------------------------------------------------------------------------------------------------------------------------------------------------------------------------------------------------------------------------------------------------------------------------------------------------------------------------------------------------------------|----------------|
| Private IP address when you add a node in the cluster - PrivNIC<br><i>(privnic_ip_newnode)</i>     | <b>192.168.12.5</b> (on sys2)<br><br><b>Note:</b> The IP addresses must not contain leading zeroes in any of the octets that comprise the address for example 0X.X.X.X or X0X.X.X, or X.X.0X.X, or X.X.X.0X. Make sure that the private IP addresses have a format as displayed in the above examples for sys1 and sys2.                                                                                                                                                                                                                                                                                                                                                                                                                                                                                                                                                                                                                                                        |                |
| NIC address for network on first node in the cluster<br><i>(nic1_node1)</i><br><i>(nic2_node1)</i> | <p>You have to choose an LLT device as a device for the Oracle Clusterware heartbeat. The interfaces specified should be exactly the same in name and total number as those which have been used for LLT configuration.</p> <p>For example, if the LLT devices on sys1 are lan1, lan2:</p> <p><b>lan1, lan2</b></p> <p>Then the PrivNIC or MultiPrivNIC device names will be as follows:</p> <p><b>Device@sys1= { lan1 = 0, lan2 = 1 }</b></p> <p>If aggregated device names are configured under LLT, then the aggregated names must be used in PrivNIC or MultiPrivNIC agent.</p> <p><b>Note:</b> If you configured aggregated interfaces for LLT, then you must set the Device attribute value to use the same aggregated interface names that you configured for LLT.</p> <p>For example, if LLT device name on sys1 is:</p> <p><b>aggr1</b></p> <p>Then the Device Attribute for the MultiPrivNIC agent would be as follows:</p> <p><b>Device@sys1 = { aggr1 = 0 }</b></p> |                |

**Table C-11** Sample value sheet - PrivNIC and MultiPrivNIC (*continued*)

| Information                                                                                                    | Sample value                                                                                                                                                                                                                                                                                                                                                                                                                                                                                                                                                                                                                                                                                                                                                                                                                                                                                                                                                                                        | Assigned value |
|----------------------------------------------------------------------------------------------------------------|-----------------------------------------------------------------------------------------------------------------------------------------------------------------------------------------------------------------------------------------------------------------------------------------------------------------------------------------------------------------------------------------------------------------------------------------------------------------------------------------------------------------------------------------------------------------------------------------------------------------------------------------------------------------------------------------------------------------------------------------------------------------------------------------------------------------------------------------------------------------------------------------------------------------------------------------------------------------------------------------------------|----------------|
| <p>NIC address for network on second node in the cluster<br/> <i>(nic1_node2)</i><br/> <i>(nic2_node2)</i></p> | <p>You have to choose an LLT device as a device for the Oracle Clusterware heartbeat. The interfaces specified should be exactly the same in name and total number as those which have been used for LLT configuration.</p> <p>For example, if the LLT devices on sys2 are lan1, lan2:</p> <p><b>lan1, lan2</b> (on sys2)</p> <p>Then the PrivNIC or MultiPrivNIC device names will be as follows:</p> <p><b>Device@sys2= { lan1 = 0, lan2 = 1 }</b></p> <p>If aggregated device names are configured under LLT, then the aggregated names must be used in PrivNIC or MultiPrivNIC agent.</p> <p><b>Note:</b> If you configured aggregated interfaces for LLT, then you must set the Device attribute value to use the same aggregated interface names that you configured for LLT.</p> <p>For example, if LLT device name on sys2 is:</p> <p><b>aggr1</b> (on sys2)</p> <p>Then the Device Attribute for the MultiPrivNIC agent would be as follows:</p> <p><b>Device@sys2 = { aggr1 = 0 }</b></p> |                |
| <p>VCS resource name for PrivNIC<br/> <i>(priv_resname)</i></p>                                                | <p><b>ora_priv</b></p>                                                                                                                                                                                                                                                                                                                                                                                                                                                                                                                                                                                                                                                                                                                                                                                                                                                                                                                                                                              |                |
| <p>VCS resource name for MultiPrivNIC<br/> <i>(multipriv_resname)</i></p>                                      | <p><b>multi_priv</b></p>                                                                                                                                                                                                                                                                                                                                                                                                                                                                                                                                                                                                                                                                                                                                                                                                                                                                                                                                                                            |                |

**Table C-11** Sample value sheet - PrivNIC and MultiPrivNIC (*continued*)

| Information                                                                                                                                                             | Sample value                                                                                                                                                                                                                                                                                                                                                                                                                                                                                                                                                                                                                                                                                                                                                                                                                                                                                                                                                 | Assigned value |
|-------------------------------------------------------------------------------------------------------------------------------------------------------------------------|--------------------------------------------------------------------------------------------------------------------------------------------------------------------------------------------------------------------------------------------------------------------------------------------------------------------------------------------------------------------------------------------------------------------------------------------------------------------------------------------------------------------------------------------------------------------------------------------------------------------------------------------------------------------------------------------------------------------------------------------------------------------------------------------------------------------------------------------------------------------------------------------------------------------------------------------------------------|----------------|
| Private IP addresses for first node in the cluster - MultiPrivNIC<br>( <i>multipriv_ip1_node1</i> )<br>( <i>multipriv_ip2_node1</i> )<br>( <i>multipriv_ip3_node1</i> ) | <p>On sys1:</p> <ul style="list-style-type: none"> <li>■ <b>192.168.12.1</b> (Oracle Clusterware)</li> <li>■ <b>192.168.2.1</b> (UDP to use for the CLUSTER_INTERCONNECT parameter)</li> <li>■ <b>192.168.3.1</b> (Second UDP to use for the CLUSTER_INTERCONNECT parameter)</li> </ul> <p><b>Note:</b> The IP addresses must not contain leading zeroes in any of the octets that comprise the address for example 0X.X.X.X or X.0X.X.X, or X.X.0X.X, or X.X.X.0X. Make sure that the private IP addresses have a format as displayed in the above examples for sys1 and sys2.</p> <p>Symantec recommends that all Oracle Clusterware and UDP cache-fusion links be LLT links.</p> <p>To avoid routing issues, ensure that the private IP addresses assigned to the first NIC (Clusterware and UDP 1) are using the same subnet. Additionally, ensure that the third IP address (UDP 2) for the second NIC is on a different subnet than the first NIC.</p> |                |



**Table C-11** Sample value sheet - PrivNIC and MultiPrivNIC (*continued*)

| Information                                                                                                                                                                           | Sample value                                                                                                                                                                                                                                                                                                                                                                                                                                                                                                                                                                                                                                                                                                                                                                                                                                                                                                                                                 | Assigned value |
|---------------------------------------------------------------------------------------------------------------------------------------------------------------------------------------|--------------------------------------------------------------------------------------------------------------------------------------------------------------------------------------------------------------------------------------------------------------------------------------------------------------------------------------------------------------------------------------------------------------------------------------------------------------------------------------------------------------------------------------------------------------------------------------------------------------------------------------------------------------------------------------------------------------------------------------------------------------------------------------------------------------------------------------------------------------------------------------------------------------------------------------------------------------|----------------|
| <p>Private IP addresses for second node in the cluster - MultiPrivNIC</p> <p>(<i>multipriv_ip1_node2</i>)</p> <p>(<i>multipriv_ip2_node2</i>)</p> <p>(<i>multipriv_ip3_node2</i>)</p> | <p>On sys2:</p> <ul style="list-style-type: none"> <li>■ <b>192.168.12.2</b> (Oracle Clusterware)</li> <li>■ <b>192.168.2.2</b> (UDP to use for the CLUSTER_INTERCONNECT parameter)</li> <li>■ <b>192.168.3.2</b> (Second UDP to use for the CLUSTER_INTERCONNECT parameter)</li> </ul> <p><b>Note:</b> The IP addresses must not contain leading zeroes in any of the octets that comprise the address for example 0X.X.X.X or X.0X.X.X, or X.X.0X.X, or X.X.X.0X. Make sure that the private IP addresses have a format as displayed in the above examples for sys1 and sys2.</p> <p>Symantec recommends that all Oracle Clusterware and UDP cache-fusion links be LLT links.</p> <p>To avoid routing issues, ensure that the private IP addresses assigned to the first NIC (Clusterware and UDP 1) are using the same subnet. Additionally, ensure that the third IP address (UDP 2) for the second NIC is on a different subnet than the first NIC.</p> |                |

**Table C-11** Sample value sheet - PrivNIC and MultiPrivNIC (*continued*)

| Information                                                                                                                                        | Sample value                                                                                                                                                                                                                                                                                                                                                                                                                                                                                                                                                                                                                                                                                                                                                                                                                                                    | Assigned value |
|----------------------------------------------------------------------------------------------------------------------------------------------------|-----------------------------------------------------------------------------------------------------------------------------------------------------------------------------------------------------------------------------------------------------------------------------------------------------------------------------------------------------------------------------------------------------------------------------------------------------------------------------------------------------------------------------------------------------------------------------------------------------------------------------------------------------------------------------------------------------------------------------------------------------------------------------------------------------------------------------------------------------------------|----------------|
| Private IP addresses when you add a new node in the cluster - MultiPrivNIC<br>( <i>multipriv_ip1_newnode</i> )<br>( <i>multipriv_ip2_newnode</i> ) | On sys2:<br><ul style="list-style-type: none"> <li>■ <b>192.168.12.5</b> (Oracle Clusterware)</li> <li>■ <b>192.168.2.6</b> (UDP to use for the CLUSTER_INTERCONNECT parameter)</li> </ul> <p><b>Note:</b> The IP addresses must not contain leading zeroes in any of the octets that comprise the address for example 0X.X.X.X or X.0X.X.X, or X.X.0X.X, or X.X.X.0X. Make sure that the private IP addresses have a format as displayed in the above examples for sys1 and sys2.</p> <p>Symantec recommends that all Oracle Clusterware and UDP cache-fusion links be LLT links.</p> <p>To avoid routing issues, ensure that the private IP addresses assigned to the first NIC (Clusterware and UDP 1) are using the same subnet. Additionally, ensure that the third IP address (UDP 2) for the second NIC is on a different subnet than the first NIC.</p> |                |
| Private hostnames (set in /etc/hosts) for first node in the cluster<br>( <i>ip_node1</i> )                                                         | On sys1:<br><ul style="list-style-type: none"> <li>■ <b>sys1-priv</b></li> <li>■ <b>sys1-priv1</b></li> </ul>                                                                                                                                                                                                                                                                                                                                                                                                                                                                                                                                                                                                                                                                                                                                                   |                |
| Private hostnames (set in /etc/hosts) for second node in the cluster<br>( <i>ip_node2</i> )                                                        | On sys2:<br><ul style="list-style-type: none"> <li>■ <b>sys2-priv</b></li> <li>■ <b>sys2-priv1</b></li> </ul>                                                                                                                                                                                                                                                                                                                                                                                                                                                                                                                                                                                                                                                                                                                                                   |                |
| Netmask for cluster<br>( <i>netmask_ip</i> )                                                                                                       | <b>255.255.255.0</b>                                                                                                                                                                                                                                                                                                                                                                                                                                                                                                                                                                                                                                                                                                                                                                                                                                            |                |

Table C-12 displays sample values that may be used when you create the Oracle RAC home directories.

**Table C-12** Sample value sheet - Oracle RAC home directories

| Information                                                                                                                                       | Sample value                                                                                                                                                                                                                                                               | Assigned value |
|---------------------------------------------------------------------------------------------------------------------------------------------------|----------------------------------------------------------------------------------------------------------------------------------------------------------------------------------------------------------------------------------------------------------------------------|----------------|
| Disk for each node that contains the Oracle Clusterware and database binaries<br><i>disk_name</i>                                                 | <b>Disk_1</b>                                                                                                                                                                                                                                                              |                |
| VxVM local disk group name<br><i>dg_name</i>                                                                                                      | <ul style="list-style-type: none"> <li>■ <b>bindg_sys1</b> (on sys1)</li> <li>■ <b>bindg_sys2</b> (on sys2)</li> </ul>                                                                                                                                                     |                |
| CVM disk group name<br><i>cvm_dg</i>                                                                                                              | <b>bindg</b>                                                                                                                                                                                                                                                               |                |
| Volume name for Oracle Clusterware binaries<br><i>clus_volname</i>                                                                                | <ul style="list-style-type: none"> <li>■ For Oracle Clusterware<br/><b>crsbinvol</b></li> <li>■ For Oracle Grid Infrastructure<br/><b>gridbinvol</b></li> </ul>                                                                                                            |                |
| Oracle Clusterware home directory<br><i>clus_home</i>                                                                                             | <ul style="list-style-type: none"> <li>■ For Oracle Clusterware, path to <i>crs_home</i><br/><b>/u01/app/oracle/product/10.2.0/crshome</b></li> <li>■ For Oracle Grid Infrastructure, path to <i>grid_home</i><br/><b>/u01/app/grid/product/11.2.0/gridhome</b></li> </ul> |                |
| Volume name for Oracle Database binaries<br><i>ora_volname</i>                                                                                    | <b>orabinvol</b>                                                                                                                                                                                                                                                           |                |
| VCS resource name for disk groups containing the Oracle Clusterware/Grid Infrastructure and Oracle Database home directories<br><i>dg_resname</i> | <b>bin_dg</b>                                                                                                                                                                                                                                                              |                |

**Table C-12** Sample value sheet - Oracle RAC home directories (*continued*)

| Information                                                                       | Sample value                                                                                                                                                                                                                                                                                                     | Assigned value |
|-----------------------------------------------------------------------------------|------------------------------------------------------------------------------------------------------------------------------------------------------------------------------------------------------------------------------------------------------------------------------------------------------------------|----------------|
| Oracle Clusterware binary mount point resource name<br><i>clusbin_mnt_resname</i> | <ul style="list-style-type: none"> <li>■ For Oracle Clusterware<br/><b>crsbin_mnt</b></li> <li>■ For Oracle Grid Infrastructure<br/><b>gridbin_mnt</b></li> </ul>                                                                                                                                                |                |
| Oracle Database binary mount point resource name<br><i>orabin_mnt_resname</i>     | <b>orabin_mnt</b>                                                                                                                                                                                                                                                                                                |                |
| Oracle base directory for Oracle Clusterware<br><i>oracle_base</i>                | <b>/u01/app/oracle</b>                                                                                                                                                                                                                                                                                           |                |
| Oracle base directory for Oracle Grid Infrastructure<br><i>grid_base</i>          | <b>/u01/app/grid</b>                                                                                                                                                                                                                                                                                             |                |
| Oracle base directory for Database<br><i>oracle_base</i>                          | <b>/u01/app/oracle</b>                                                                                                                                                                                                                                                                                           |                |
| Oracle Database home directory<br><i>db_home</i>                                  | <ul style="list-style-type: none"> <li>■ Oracle RAC 10g Release 2:<br/><b>/u02/app/oracle/product/10.2.0/dbhome_1</b></li> <li>■ Oracle RAC 11g Release 1:<br/><b>/u02/app/oracle/product/11.1.0/dbhome_1</b></li> <li>■ Oracle RAC 11g Release 2:<br/><b>/u02/app/oracle/product/11.2.0/dbhome_1</b></li> </ul> |                |
| Oracle Grid Infrastructure home directory<br><i>grid_home</i>                     | <b>/u01/app/11.2.0/grid</b>                                                                                                                                                                                                                                                                                      |                |

**Table C-13** displays sample values that may be used when you create the storage for OCR and voting disk.

**Table C-13** Sample value sheet - OCR and voting disk

| Information                                                                                                      | Sample value                       | Assigned value |
|------------------------------------------------------------------------------------------------------------------|------------------------------------|----------------|
| Disks for creating a shared disk group for OCR and voting disk<br><br><i>disk_name2</i><br><br><i>disk_name3</i> | <b>Disk_2</b><br><br><b>Disk_3</b> |                |
| Shared disk group for OCR and voting disk<br><br><i>ocrvote_dgname</i>                                           | <b>ocrvotedg</b>                   |                |
| OCR volume on CVM raw volumes<br><br><i>ocr_volname</i>                                                          | <b>ocrvol</b>                      |                |
| Voting disk volume on CVM raw volumes<br><br><i>vote_volname</i>                                                 | <b>votevol</b>                     |                |
| OCR and voting disk volume on CFS<br><br><i>ocrvote_volname</i>                                                  | <b>ocrvotevol</b>                  |                |
| Volume options for OCR and voting disk                                                                           | nmirror=2                          |                |
| File system on shared volume (CFS)                                                                               | /dev/vx/rdisk/ocrvotedg/ocrvotevol |                |
| Mount point for shared file system<br><br><i>ocrvote_mnt</i>                                                     | <b>/ocrvote</b>                    |                |
| CVMVolDg resource name for OCR and voting disk<br><br><i>ocrvotevol_resname</i>                                  | <b>ocrvote_voldg_ocrvotedg</b>     |                |
| CFSMount resource name for OCR and voting disk<br><br><i>ocrvotemnt_resname</i>                                  | <b>ocrvote_mnt_ocrvotedg</b>       |                |

**Table C-13** Sample value sheet - OCR and voting disk (*continued*)

| Information                          | Sample value    | Assigned value |
|--------------------------------------|-----------------|----------------|
| Mount point for archive logs         | <b>/oradata</b> |                |
| CVM group name<br><i>cvm_grpname</i> | <b>cvm</b>      |                |

**Table C-14** displays sample values that may be used when you configure the CSSD agent and the Oracle database.

**Table C-14** Sample value sheet - CSSD and Oracle database configuration

| Information                                                   | Sample value                                  | Assigned value |
|---------------------------------------------------------------|-----------------------------------------------|----------------|
| CVM group name<br><i>cvm_grpname</i>                          | <b>cvm</b>                                    |                |
| CSSD group name<br><i>cssd_grpname</i>                        | <b>cssd</b>                                   |                |
| VCS service group for Oracle Database<br><i>oradb_grpname</i> | <b>oradb_grp</b>                              |                |
| VCS resource name for Oracle<br><i>db_resname</i>             | <b>oradb</b>                                  |                |
| Oracle database name<br><i>db_name</i>                        | <b>db</b>                                     |                |
| Global Database Name                                          | db.symantecexample.com (database name.domain) |                |
| Disk group name for Oracle Database<br><i>oradb_dgname</i>    | <b>oradatadg</b> (Shared)                     |                |
| Volume name for Oracle Database<br><i>oradb_volname</i>       | <b>oradatavol</b>                             |                |

**Table C-14** Sample value sheet - CSSD and Oracle database configuration  
*(continued)*

| Information                                                        | Sample value             | Assigned value |
|--------------------------------------------------------------------|--------------------------|----------------|
| Mount point for Oracle Database<br><i>oradb_mnt</i>                | <b>/oradata</b> (Shared) |                |
| CVMVolDg resource for Oracle Database<br><i>orabdg_resname</i>     | <b>oradata_voldg</b>     |                |
| CFSMount resource for Oracle Database<br><i>orabmnt_resname</i>    | <b>oradata_mnt</b>       |                |
| SID prefix for policy-managed databases<br><i>oradb_sid_prefix</i> | <b>db</b>                |                |
| SID on first node in the cluster<br><i>oradb_sid_node1</i>         | <b>db1</b>               |                |
| SID on second node in the cluster<br><i>oradb_sid_node2</i>        | <b>db2</b>               |                |

## Replicated cluster using VVR worksheet

Table C-15 contains the sample values that may be used when you install and configure CVM and VVR. If applicable, enter the CVM/VVR values for your systems in the following table:

**Table C-15** Replicated cluster using VVR worksheet

| Installation information         | Sample value     | Assigned value |
|----------------------------------|------------------|----------------|
| Host names for Secondary Cluster | mercury, jupiter |                |
| Secondary Cluster Name           | rac_cluster102   |                |

**Table C-15** Replicated cluster using VVR worksheet (*continued*)

| Installation information                                                      | Sample value                | Assigned value |
|-------------------------------------------------------------------------------|-----------------------------|----------------|
| Secondary cluster ID number                                                   | 102                         |                |
| Primary Cluster Address                                                       | 10.10.10.101                |                |
| Primary Cluster Logowner IP                                                   | 10.10.9.101                 |                |
| Secondary Cluster Address                                                     | 10.11.10.102                |                |
| Secondary Cluster Logowner IP                                                 | 10.11.9.102                 |                |
| RVG Name                                                                      | rac1_rvg                    |                |
| Global Database Name                                                          | vrts                        |                |
| Database Resource Name                                                        | ora1                        |                |
| Database Group Name<br>(depends on cvm, includes resources oracle agent etc.) | oradb1_grp                  |                |
| Srl Volume Name                                                               | rac1_srl                    |                |
| Resolvable Virtual Hostname of the cluster on Primary Site (for VVR)          | rac_clus101_priv            |                |
| Resolvable Virtual Hostname of the cluster on Secondary Site (for VVR)        | rac_clus102_priv            |                |
| Private IP addresses for Secondary Cluster                                    | 192.168.12.3 - 192.168.12.4 |                |

## Replicated cluster using SRDF worksheet

**Table C-16** contains the sample values that may be used when you install and configure CVM and VVR. If applicable, enter the CVM/VVR values for your systems in the following table:



**Table C-16** Replicated cluster using SRDF worksheet

| Installation information                                                   | Sample value                   | Assigned value |
|----------------------------------------------------------------------------|--------------------------------|----------------|
| Host names for Secondary Cluster                                           | mercury, jupiter               |                |
| Secondary Cluster Name                                                     | rac_cluster102                 |                |
| Secondary cluster ID number                                                | 102                            |                |
| Primary Cluster Address                                                    | 10.10.10.101                   |                |
| Primary Cluster Logowner IP                                                | 10.10.9.101                    |                |
| Secondary Cluster Address                                                  | 10.11.10.102                   |                |
| Secondary Cluster Logowner IP                                              | 10.11.9.102                    |                |
| RVG Name                                                                   | rac1_rvg                       |                |
| Global Database Name                                                       | vrts                           |                |
| Database Resource Name                                                     | ora1                           |                |
| Database Group Name (depends on cvm, includes resources oracle agent etc.) | oradb1_grp                     |                |
| Srl Volume Name                                                            | rac1_srl                       |                |
| Resolvable Virtual Hostname of the cluster on Primary Site (for VVR)       | rac_clus101_priv               |                |
| Resolvable Virtual Hostname of the cluster on Secondary Site (for VVR)     | rac_clus102_priv               |                |
| Private IP addresses for Secondary Cluster                                 | 192.168.12.3 -<br>192.168.12.4 |                |

# Required installation information for Oracle Clusterware/Grid Infrastructure

This section describes the information required by the Oracle Universal Installer for installing the Oracle Clusterware/Grid Infrastructure software.

[Table C-17](#) lists the information required by the Oracle Universal Installer when you install Oracle Clusterware.

**Table C-17** Required installation information for Oracle Clusterware - Oracle RAC 10g Release 2/Oracle RAC 11g Release 1

| OUI menu                                         | Description                                                                                                                                                                                                                                                                                                                                                                                                                                                                                               |
|--------------------------------------------------|-----------------------------------------------------------------------------------------------------------------------------------------------------------------------------------------------------------------------------------------------------------------------------------------------------------------------------------------------------------------------------------------------------------------------------------------------------------------------------------------------------------|
| <b>Specify Inventory Details and Credentials</b> | <p>Enter the full path of the inventory directory and the operating system group name.</p> <p><b>Note:</b> Retain the directory paths and operating system group name suggested by the installer. Changing the information results in failure of certain post-verification tasks.</p>                                                                                                                                                                                                                     |
| <b>Specify Home Details</b>                      | <p>Enter the path to the CRS home directory.</p> <p>The Oracle Universal Installer performs product-specific prerequisite checks and verifies that your environment meets all of the minimum requirements for installing Oracle RAC. You must manually verify and confirm the items that are flagged with warnings and items that require manual checks.</p> <p>The OUI displays the full path of the oraInventory logs. Make a note of the log file path to verify the installation at a later time.</p> |
| <b>Specify cluster configuration</b>             | <p>Verify the cluster name and the nodes to be managed by Oracle Clusterware.</p>                                                                                                                                                                                                                                                                                                                                                                                                                         |

**Table C-17** Required installation information for Oracle Clusterware - Oracle RAC 10g Release 2/Oracle RAC 11g Release 1 (*continued*)

| OUI menu                                                 | Description                                                                                                                                                                                                                                                                                                                                                                                                                                                                                                                                                                                                                                                                      |
|----------------------------------------------------------|----------------------------------------------------------------------------------------------------------------------------------------------------------------------------------------------------------------------------------------------------------------------------------------------------------------------------------------------------------------------------------------------------------------------------------------------------------------------------------------------------------------------------------------------------------------------------------------------------------------------------------------------------------------------------------|
| <b>Specify network interface usage</b>                   | <p>Identify the planned use for each interface: Public, Private, or Do Not use.</p> <p><b>Note:</b> Make sure that the same private interfaces that you specified at the time of configuring PrivNIC and MultiPrivNIC are listed on the screen.</p> <p><b>Note:</b> Mark the interfaces for the subnet containing the private IP addresses managed by the PrivNIC/MultiPrivNIC agents as 'Private'.</p> <p>The interfaces that are <b>Private</b> are stored in OCR as a 'cluster_interconnect' for database cache fusion traffic. Oracle recommends the use of a common private interface for both Oracle Clusterware and Oracle RAC database.</p>                              |
| <b>Specify Oracle Cluster Registry (OCR) information</b> | <p>Enter the full path of the location where you want to store the OCR information.</p> <p>For example, if you are storing the OCR information on CFS, enter: <code>/ocrvote/ocr</code>.</p> <p><b>Note:</b> Store the OCR information at the root of the file system. If you place the OCR information under a directory on CFS, the configuration of the CSSD agent after Oracle RAC installation fails.</p> <p>If you are storing the OCR information on raw volumes, enter: <code>/dev/vx/rdisk/ocrvotedg/ocrvol</code></p> <p><b>Note:</b> Select the option <b>External Redundancy</b>. OCR mirroring is performed by CVM if you have chosen to mirror the OCR volume.</p> |

**Table C-17** Required installation information for Oracle Clusterware - Oracle RAC 10g Release 2/Oracle RAC 11g Release 1 (*continued*)

| OUI menu                            | Description                                                                                                                                                                                                                                                                                                                                                                                                                                                                                                                                                                                                                                                                                                                               |
|-------------------------------------|-------------------------------------------------------------------------------------------------------------------------------------------------------------------------------------------------------------------------------------------------------------------------------------------------------------------------------------------------------------------------------------------------------------------------------------------------------------------------------------------------------------------------------------------------------------------------------------------------------------------------------------------------------------------------------------------------------------------------------------------|
| <b>Specify voting disk location</b> | <p>Enter the full path of the location where you want to store the voting disk information.</p> <p>For example, if you are storing the voting disk information on CFS, enter: <code>/ocrvote/vote</code></p> <p><b>Note:</b> Store the voting disk information at the root of the file system. If you place the voting disk information under a directory on CFS, the configuration of the CSSD agent after Oracle RAC installation fails.</p> <p>If you are storing the voting disk information on raw volumes, enter: <code>/dev/vx/rdisk/ocrvotedg/votevol</code></p> <p><b>Note:</b> Select the option <b>External Redundancy</b>. Voting disk redundancy is provided by CVM if you have chosen to mirror the voting disk volume.</p> |

**Table C-18** lists the information required by the Oracle Universal Installer when you install Oracle Grid Infrastructure.

**Table C-18** Required installation information for Oracle Grid Infrastructure - Oracle RAC 11g Release 2

| OUI menu                              | Description                                                                                                                                                                                                                                                                             |
|---------------------------------------|-----------------------------------------------------------------------------------------------------------------------------------------------------------------------------------------------------------------------------------------------------------------------------------------|
| <b>Select installation option</b>     | Select the option <b>Install and Configure Grid Infrastructure for a Cluster</b> .                                                                                                                                                                                                      |
| <b>Select installation type</b>       | Select the option <b>Advanced Installation</b> .                                                                                                                                                                                                                                        |
| <b>Specify cluster configuration</b>  | Enter the SCAN name for the cluster that will be used by the database clients to connect to databases within the cluster.                                                                                                                                                               |
| <b>Grid Plug and Play information</b> | <p>Provide the following information:</p> <ul style="list-style-type: none"> <li>■ Name of the cluster</li> <li>■ SCAN name<br/>The SCAN address on the domain name server (DNS) must resolve to three addresses (recommended) or at least one address.</li> <li>■ SCAN port</li> </ul> |

**Table C-18** Required installation information for Oracle Grid Infrastructure - Oracle RAC 11g Release 2 (*continued*)

| OUI menu                               | Description                                                                                                                                                                                                                                                                                                                                                                                                                                                                                                                                                                                                                                                                                                                               |
|----------------------------------------|-------------------------------------------------------------------------------------------------------------------------------------------------------------------------------------------------------------------------------------------------------------------------------------------------------------------------------------------------------------------------------------------------------------------------------------------------------------------------------------------------------------------------------------------------------------------------------------------------------------------------------------------------------------------------------------------------------------------------------------------|
| <b>Specify network interface usage</b> | <p>Identify the planned use for each interface: Public, Private, or Do Not use.</p> <p><b>Note:</b> Make sure that the same private interfaces that you specified at the time of configuring PrivNIC and MultiPrivNIC are listed on the screen.</p> <p><b>Note:</b> Mark the interfaces for the subnet containing the private IP addresses managed by the PrivNIC/MultiPrivNIC agents as 'Private'.</p> <p>The interfaces that are <b>Private</b> are stored in GPnP profile as a 'cluster_interconnect' for Oracle Grid Infrastructure communication and database cache fusion traffic.</p>                                                                                                                                              |
| <b>Storage option information</b>      | Select the option <b>Shared File System</b> .                                                                                                                                                                                                                                                                                                                                                                                                                                                                                                                                                                                                                                                                                             |
| <b>OCR storage option</b>              | <p>Enter the full path of the location where you want to store the OCR information.</p> <p>For example, if you are storing the OCR information on CFS, enter: <code>/ocrvote/ocr</code>.</p> <p><b>Note:</b> Select the option <b>External Redundancy</b> when you install Oracle Clusterware/Grid Infrastructure. Mirroring is performed by CVM if you have chosen to mirror the OCR volume.</p> <p>If you are storing the OCR information on an ASM disk group that uses CVM raw volumes, enter:<br/><code>/dev/vx/rdisk/ocrvotedg/ocrvol</code></p> <p><b>Note:</b> Select the option <b>External</b> when you create the ASM disk group and instances. Mirroring is performed by CVM if you have chosen to mirror the OCR volume.</p> |

**Table C-18** Required installation information for Oracle Grid Infrastructure - Oracle RAC 11g Release 2 (*continued*)

| OUI menu                             | Description                                                                                                                                                                                                                                                                                                                                                                                                                                                                                                                                                                                                                                                                                                                                                                         |
|--------------------------------------|-------------------------------------------------------------------------------------------------------------------------------------------------------------------------------------------------------------------------------------------------------------------------------------------------------------------------------------------------------------------------------------------------------------------------------------------------------------------------------------------------------------------------------------------------------------------------------------------------------------------------------------------------------------------------------------------------------------------------------------------------------------------------------------|
| <b>Voting Disk storage option</b>    | <p>Enter the full path of the location where you want to store the voting disk information.</p> <p>For example, if you are storing the voting disk information on CFS, enter: <code>/ocrvote/vote</code></p> <p><b>Note:</b> Select the option <b>External Redundancy</b> when you install Oracle Clusterware/Grid Infrastructure. Mirroring is performed by CVM if you have chosen to mirror the voting disk volume.</p> <p>If you are storing the voting disk information on an ASM disk group that uses CVM raw volumes, enter:<br/> <code>/dev/vx/rdisk/ocrvotedg/votevol</code></p> <p><b>Note:</b> Select the option <b>External</b> when you create the ASM disk group and instances. Mirroring is performed by CVM if you have chosen to mirror the voting disk volume.</p> |
| <b>Specify installation location</b> | Enter the full path to the Oracle base directory and the Oracle Grid Infrastructure home directory.                                                                                                                                                                                                                                                                                                                                                                                                                                                                                                                                                                                                                                                                                 |
| <b>Create inventory</b>              | Enter the full path to the Oracle inventory directory where you want to store the installation files.                                                                                                                                                                                                                                                                                                                                                                                                                                                                                                                                                                                                                                                                               |

## Required installation information for Oracle database

This section describes the information required by the Oracle Universal Installer for installing the Oracle database software.

[Table C-19](#) lists the information required by the Oracle Universal Installer when you install Oracle database software.

**Table C-19** Required installation information for Oracle database - Oracle RAC 10g Release 2/Oracle RAC 11g Release 1

| OUI menu                        | Description                                                      |
|---------------------------------|------------------------------------------------------------------|
| <b>Select installation type</b> | Select <b>Enterprise Edition</b> .                               |
| <b>Specify home details</b>     | Review or enter the ORACLE_HOME and ORACLE_BASE directory paths. |

**Table C-19** Required installation information for Oracle database - Oracle RAC 10g Release 2/Oracle RAC 11g Release 1 (*continued*)

| OUI menu                                          | Description                                                                                                                                                                                                                                                                                                                                                                                                                   |
|---------------------------------------------------|-------------------------------------------------------------------------------------------------------------------------------------------------------------------------------------------------------------------------------------------------------------------------------------------------------------------------------------------------------------------------------------------------------------------------------|
| <b>Specify Hardware Cluster Installation Mode</b> | <p>Select <b>Cluster Installation</b>.</p> <p>Select the nodes on which you want to install the Oracle RAC database software.</p> <p>The Oracle Universal Installer runs a product-specific prerequisite check. Any items that are flagged must be manually checked and configured. The OUI displays the full path of the oraInventory logs. Make a note of the log file path to verify the installation at a later time.</p> |
| <b>Select Configuration Option</b>                | <p>Select the option <b>Install database software only</b>.</p> <p><b>Note:</b> Do not select the option <b>Create a database</b>. Symantec recommends that you create the database later.</p>                                                                                                                                                                                                                                |

[Table C-20](#) lists the information required by the Oracle Universal Installer when you install Oracle database software.

**Table C-20** Required installation information for Oracle database - Oracle RAC 11g Release 2

| OUI menu                             | Description                                                                                                                                                                                                                  |
|--------------------------------------|------------------------------------------------------------------------------------------------------------------------------------------------------------------------------------------------------------------------------|
| <b>Select installation option</b>    | Select the option <b>Install database software only</b> .                                                                                                                                                                    |
| <b>Node selection</b>                | <p>Select <b>Real Application Clusters database installation</b>.</p> <p>Select the nodes on which the Oracle RAC database software must be installed.</p>                                                                   |
| <b>Select database edition</b>       | Select <b>Enterprise Edition</b> .                                                                                                                                                                                           |
| <b>Specify installation location</b> | <p>Review or enter the ORACLE_BASE and ORACLE_HOME directory paths.</p> <p>The Oracle Universal Installer runs product-specific prerequisite checks. Any items that are flagged must be manually checked and configured.</p> |

# Sample configuration files

This appendix includes the following topics:

- [About VCS configuration file](#)
- [About the LLT and GAB configuration files](#)
- [About I/O fencing configuration files](#)
- [Sample configuration files](#)

## About VCS configuration file

This section provides a high-level overview of the contents of the VCS configuration file after the SF Oracle RAC installation. Review the configuration file after the SF Oracle RAC installation and before the Oracle installation.

The configuration file includes the following information:

- The "include" statements list the various VCS types files (`.conf`) for SF Oracle RAC.  
The files are located in the `/etc/VRTSvcs/conf/config` directory. These files define the agents that control the resources in the cluster.
- The cluster definition, with the cluster name provided during installation (for example, `rac_cluster101`), includes the names of users and administrators of the cluster. The `UseFence = SCSI3` attribute is not automatically present; you must manually add it after the installation.
- The `main.cf` includes the `cvm` service group. The service group includes definitions for monitoring the CFS and the CVM resources. The `CVMCluster` agent resource definition indicates that the nodes use GAB for messaging operations.  
The `cvm` group has the `Parallel` attribute set to 1. This value enables the resources to run in parallel on each node in the system list.



# About the LLT and GAB configuration files

Low Latency Transport (LLT) and Group Membership and Atomic Broadcast (GAB) are VCS communication services. LLT requires `/etc/llthosts` and `/etc/llttab` files. GAB requires `/etc/gabtab` file.

[Table D-1](#) lists the LLT configuration files and the information that these files contain.

**Table D-1** LLT configuration files

| File                                  | Description                                                                                                                                                                                                                                                                                                                                                                                                                                                                                                                                                                                                                                                                                                                                                                                                |
|---------------------------------------|------------------------------------------------------------------------------------------------------------------------------------------------------------------------------------------------------------------------------------------------------------------------------------------------------------------------------------------------------------------------------------------------------------------------------------------------------------------------------------------------------------------------------------------------------------------------------------------------------------------------------------------------------------------------------------------------------------------------------------------------------------------------------------------------------------|
| <code>/etc/rc.config.d/lltconf</code> | <p>This file stores the start and stop environment variables for LLT:</p> <ul style="list-style-type: none"> <li>■ <code>LLT_START</code>—Defines the startup behavior for the LLT module after a system reboot. Valid values include: <ul style="list-style-type: none"> <li>1—Indicates that LLT is enabled to start up.</li> <li>0—Indicates that LLT is disabled to start up.</li> </ul> </li> <li>■ <code>LLT_STOP</code>—Defines the shutdown behavior for the LLT module during a system shutdown. Valid values include: <ul style="list-style-type: none"> <li>1—Indicates that LLT is enabled to shut down.</li> <li>0—Indicates that LLT is disabled to shut down.</li> </ul> </li> </ul> <p>The installer sets the value of these variables to 1 at the end of SF Oracle RAC configuration.</p> |
| <code>/etc/llthosts</code>            | <p>The file <code>llthosts</code> is a database that contains one entry per system. This file links the LLT system ID (in the first column) with the LLT host name. This file must be identical on each node in the cluster. A mismatch of the contents of the file can cause indeterminate behavior in the cluster.</p> <p>For example, the file <code>/etc/llthosts</code> contains the entries that resemble:</p> <pre> 0      sys1 1      sys2 </pre>                                                                                                                                                                                                                                                                                                                                                  |

**Table D-1** LLT configuration files (*continued*)

| File        | Description                                                                                                                                                                                                                                                                                                                                                                                                                                                                                                                                                                                                                                                                                                                                                                                                                                                                                                                                                                                                                                                       |
|-------------|-------------------------------------------------------------------------------------------------------------------------------------------------------------------------------------------------------------------------------------------------------------------------------------------------------------------------------------------------------------------------------------------------------------------------------------------------------------------------------------------------------------------------------------------------------------------------------------------------------------------------------------------------------------------------------------------------------------------------------------------------------------------------------------------------------------------------------------------------------------------------------------------------------------------------------------------------------------------------------------------------------------------------------------------------------------------|
| /etc/llttab | <p>The file <code>llttab</code> contains the information that is derived during installation and used by the utility <code>lltconfig(1M)</code>. After installation, this file lists the LLT network links that correspond to the specific system.</p> <p>For example, the file <code>/etc/llttab</code> contains the entries that resemble:</p> <pre> set-node sys1 set-cluster 2 link lan1 /dev/lan:1 - ether - - link lan2 /dev/lan:2 - ether - - </pre> <p>The first line identifies the system. The second line identifies the cluster (that is, the cluster ID you entered during installation). The next two lines begin with the <code>link</code> command. These lines identify the two network cards that the LLT protocol uses.</p> <p>If you configured a low priority link under LLT, the file also includes a "link-lowpri" line.</p> <p>Refer to the <code>llttab(4)</code> manual page for details about how the LLT configuration may be modified. The manual page describes the ordering of the directives in the <code>llttab</code> file.</p> |

[Table D-2](#) lists the GAB configuration files and the information that these files contain.

**Table D-2** GAB configuration files

| File                     | Description                                                                                                                                                                                                                                                                                                                                                                                                                                                                                                                                                                                                                                                                                                                                                                                    |
|--------------------------|------------------------------------------------------------------------------------------------------------------------------------------------------------------------------------------------------------------------------------------------------------------------------------------------------------------------------------------------------------------------------------------------------------------------------------------------------------------------------------------------------------------------------------------------------------------------------------------------------------------------------------------------------------------------------------------------------------------------------------------------------------------------------------------------|
| /etc/rc.config.d/gabconf | <p>This file stores the start and stop environment variables for GAB:</p> <ul style="list-style-type: none"> <li>■ <b>GAB_START</b>—Defines the startup behavior for the GAB module after a system reboot. Valid values include: <ul style="list-style-type: none"> <li>1—Indicates that GAB is enabled to start up.</li> <li>0—Indicates that GAB is disabled to start up.</li> </ul> </li> <li>■ <b>GAB_STOP</b>—Defines the shutdown behavior for the GAB module during a system shutdown. Valid values include: <ul style="list-style-type: none"> <li>1—Indicates that GAB is enabled to shut down.</li> <li>0—Indicates that GAB is disabled to shut down.</li> </ul> </li> </ul> <p>The installer sets the value of these variables to 1 at the end of SF Oracle RAC configuration.</p> |

**Table D-2** GAB configuration files (*continued*)

| File        | Description                                                                                                                                                                                                                                                                                                                                                                                                                                                                                                                                                                                                                                                                                                                                                                                                                                                                     |
|-------------|---------------------------------------------------------------------------------------------------------------------------------------------------------------------------------------------------------------------------------------------------------------------------------------------------------------------------------------------------------------------------------------------------------------------------------------------------------------------------------------------------------------------------------------------------------------------------------------------------------------------------------------------------------------------------------------------------------------------------------------------------------------------------------------------------------------------------------------------------------------------------------|
| /etc/gabtab | <p>After you install SF Oracle RAC, the file /etc/gabtab contains a <code>gabconfig(1)</code> command that configures the GAB driver for use.</p> <p>The file /etc/gabtab contains a line that resembles:</p> <pre style="margin-left: 40px;">/sbin/gabconfig -c -nN</pre> <p>The <code>-c</code> option configures the driver for use. The <code>-nN</code> specifies that the cluster is not formed until at least <i>N</i> nodes are ready to form the cluster. Symantec recommends that you set <i>N</i> to be the total number of nodes in the cluster.</p> <p><b>Note:</b> Symantec does not recommend the use of the <code>-c -x</code> option for <code>/sbin/gabconfig</code>. Using <code>-c -x</code> can lead to a split-brain condition. Use the <code>-c</code> option for <code>/sbin/gabconfig</code> to avoid a split-brain condition.</p> <p><b>Note:</b></p> |

## About I/O fencing configuration files

[Table D-3](#) lists the I/O fencing configuration files.

**Table D-3** I/O fencing configuration files

| File                       | Description                                                                                                                                                                                                                                                                                                                                                                                                                                                                                                                                                                                                                                                                                                                                                                                                                                                |
|----------------------------|------------------------------------------------------------------------------------------------------------------------------------------------------------------------------------------------------------------------------------------------------------------------------------------------------------------------------------------------------------------------------------------------------------------------------------------------------------------------------------------------------------------------------------------------------------------------------------------------------------------------------------------------------------------------------------------------------------------------------------------------------------------------------------------------------------------------------------------------------------|
| /etc/rc.config.d/vxfenconf | <p>This file stores the start and stop environment variables for I/O fencing:</p> <ul style="list-style-type: none"> <li>■ <b>VXFEN_START</b>—Defines the startup behavior for the I/O fencing module after a system reboot. Valid values include: <ul style="list-style-type: none"> <li>1—Indicates that I/O fencing is enabled to start up.</li> <li>0—Indicates that I/O fencing is disabled to start up.</li> </ul> </li> <li>■ <b>VXFEN_STOP</b>—Defines the shutdown behavior for the I/O fencing module during a system shutdown. Valid values include: <ul style="list-style-type: none"> <li>1—Indicates that I/O fencing is enabled to shut down.</li> <li>0—Indicates that I/O fencing is disabled to shut down.</li> </ul> </li> </ul> <p>The installer sets the value of these variables to 1 at the end of SF Oracle RAC configuration.</p> |
| /etc/vxfendg               | <p>This file includes the coordinator disk group information.</p> <p>This file is not applicable for server-based fencing.</p>                                                                                                                                                                                                                                                                                                                                                                                                                                                                                                                                                                                                                                                                                                                             |

**Table D-3**      I/O fencing configuration files (*continued*)

| File           | Description                                                                                                                                                                                                                                                                                                                                                                                                                                                                                                                                                                                                                                                                                                                                                                                                                                                                                                                                                                                                                                                                                                                                                                                                                                                                                                                                                                                                                                                                                                                                                                                                                                                                                                                                                                                                                                                                                                                                                                                                     |
|----------------|-----------------------------------------------------------------------------------------------------------------------------------------------------------------------------------------------------------------------------------------------------------------------------------------------------------------------------------------------------------------------------------------------------------------------------------------------------------------------------------------------------------------------------------------------------------------------------------------------------------------------------------------------------------------------------------------------------------------------------------------------------------------------------------------------------------------------------------------------------------------------------------------------------------------------------------------------------------------------------------------------------------------------------------------------------------------------------------------------------------------------------------------------------------------------------------------------------------------------------------------------------------------------------------------------------------------------------------------------------------------------------------------------------------------------------------------------------------------------------------------------------------------------------------------------------------------------------------------------------------------------------------------------------------------------------------------------------------------------------------------------------------------------------------------------------------------------------------------------------------------------------------------------------------------------------------------------------------------------------------------------------------------|
| /etc/vxfenmode | <p>This file contains the following parameters:</p> <ul style="list-style-type: none"> <li>■ <code>vxfen_mode</code> <ul style="list-style-type: none"> <li>■ <code>scsi3</code>—For disk-based fencing</li> <li>■ <code>customized</code>—For server-based fencing</li> <li>■ <code>disabled</code>—To run the I/O fencing driver but not do any fencing operations.</li> </ul> </li> <li>■ <code>vxfen_mechanism</code><br/> This parameter is applicable only for server-based fencing. Set the value as <code>cps</code>.</li> <li>■ <code>scsi3_disk_policy</code><br/> You must configure the <code>vxfen</code> module to use DMP devices or iSCSI devices, and set the SCSI-3 disk policy as <code>dmp</code>.</li> <li>■ <code>security</code><br/> This parameter is applicable only for server-based fencing.<br/> 1—Indicates that communication with the CP server is in secure mode. This setting is the default.<br/> 0—Indicates that communication with the CP server is in non-secure mode.</li> <li>■ List of coordination points<br/> This list is required only for server-based fencing configuration.<br/> Coordination points in server-based fencing can include coordinator disks, CP servers, or both. If you use coordinator disks, you must create a coordinator disk group containing the individual coordinator disks.<br/> Refer to the sample file <code>/etc/vxfen.d/vxfenmode_cps</code> for more information on how to specify the coordination points and multiple IP addresses for each CP server.</li> <li>■ <code>autoseed_gab_timeout</code><br/> This parameter enables GAB automatic seeding of the cluster even when some cluster nodes are unavailable. This feature requires that I/O fencing is enabled.<br/> 0—Turns the GAB auto-seed feature on. Any value greater than 0 indicates the number of seconds that GAB must delay before it automatically seeds the cluster.<br/> -1—Turns the GAB auto-seed feature off. This setting is the default.</li> </ul> |

Table D-3 I/O fencing configuration files (*continued*)

| File                       | Description                                                                                                                                                                                                                                                                                                                                                                                                                                                                                                                                                                                                                                                                                                                                                                                                                                                                                                                                                                                                                                                           |
|----------------------------|-----------------------------------------------------------------------------------------------------------------------------------------------------------------------------------------------------------------------------------------------------------------------------------------------------------------------------------------------------------------------------------------------------------------------------------------------------------------------------------------------------------------------------------------------------------------------------------------------------------------------------------------------------------------------------------------------------------------------------------------------------------------------------------------------------------------------------------------------------------------------------------------------------------------------------------------------------------------------------------------------------------------------------------------------------------------------|
| <code>/etc/vxfentab</code> | <p>When I/O fencing starts, the <code>vxfen</code> startup script creates this <code>/etc/vxfentab</code> file on each node. The startup script uses the contents of the <code>/etc/vxfendg</code> and <code>/etc/vxfenmode</code> files. Any time a system is rebooted, the fencing driver reinitializes the <code>vxfentab</code> file with the current list of all the coordinator points.</p> <p><b>Note:</b> The <code>/etc/vxfentab</code> file is a generated file; do not modify this file.</p> <p>An example of the <code>/etc/vxfentab</code> file in a disk-based fencing configuration on one node resembles as follows:</p> <pre> /dev/vx/rdmp/c1t1d0 HITACHI%5F1724-100%20%20FAST%5FDISKS%5F6 00A0B8000215A5D000006804E795D075 /dev/vx/rdmp/c2t1d0 HITACHI%5F1724-100%20%20FAST%5FDISKS%5F6 00A0B8000215A5D000006814E795D076 /dev/vx/rdmp/c3t1d0 HITACHI%5F1724-100%20%20FAST%5FDISKS%5F6 00A0B8000215A5D000006824E795D077 </pre> <p>For server-based fencing, the <code>/etc/vxfentab</code> file also includes the security settings information.</p> |

## Sample configuration files

SF Oracle RAC provides several sample configuration files illustrating various scenarios. You may use the sample files as a guideline for setting up your cluster environment. These sample files are located at `/etc/VRTSvcs/conf/sample_rac/`.

This section briefly describes each of the sample files and illustrates the service group configuration for each of them. The section does not include a copy of the `main.cf` files.

The following sample files are discussed in this section:

- [sfrac01\\_main.cf file](#)
- [sfrac02\\_main.cf file](#)
- [sfrac03\\_main.cf file](#)
- [sfrac04\\_main.cf file](#)
- [sfrac05\\_main.cf file](#)
- [sfrac06\\_main.cf file](#)
- [sfrac07\\_main.cf and sfrac08\\_main.cf files](#)
- [sfrac09\\_main.cf and sfrac10\\_main.cf files](#)

- [sfrac11\\_main.cf file](#)
- [sfrac12\\_main.cf and sfrac13\\_main.cf files](#)
- [sfrac14\\_main.cf file](#)

## sfrac01\_main.cf file

The sample configuration is applicable only for Oracle RAC 10g installations.

This sample file describes the following configuration:

- A two node SF Oracle RAC cluster hosting single database.
- The Oracle database is stored on CFS.
- The database is managed by the VCS agent for Oracle.  
The agent starts, stops, and monitors the database.
- The database uses the VCSIPC for database cache fusion.
- Only one private IP address is configured for Oracle Clusterware. The private IP address is managed by the PrivNIC agent for high availability.
- The Oracle Cluster Registry (OCR) and voting disk are stored on CFS.

[Figure D-1](#) illustrates the configuration.

**Figure D-1** Service group configuration for sfrac01\_main.cf file

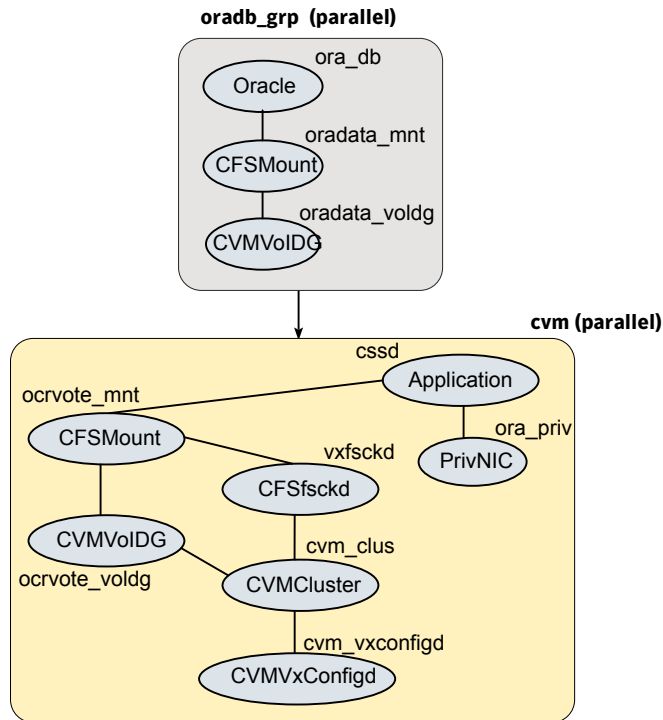

## sfrac02\_main.cf file

This sample file describes the following configuration:

- A two node SF Oracle RAC cluster hosting single database.
- The Oracle database is stored on CFS.
- The database is managed by the VCS agent for Oracle. The agent starts, stops, and monitors the database.
- The database uses the Oracle UDP IPC for database cache fusion.
- A common IP address is used by Oracle Clusterware and database cache fusion. The private IP address is managed by the PrivNIC agent for high availability.
- The Oracle Cluster Registry (OCR) and voting disk are stored on CVM raw volumes.

Figure D-2 illustrates the configuration.

**Figure D-2** Service group configuration for sfrac02\_main.cf file

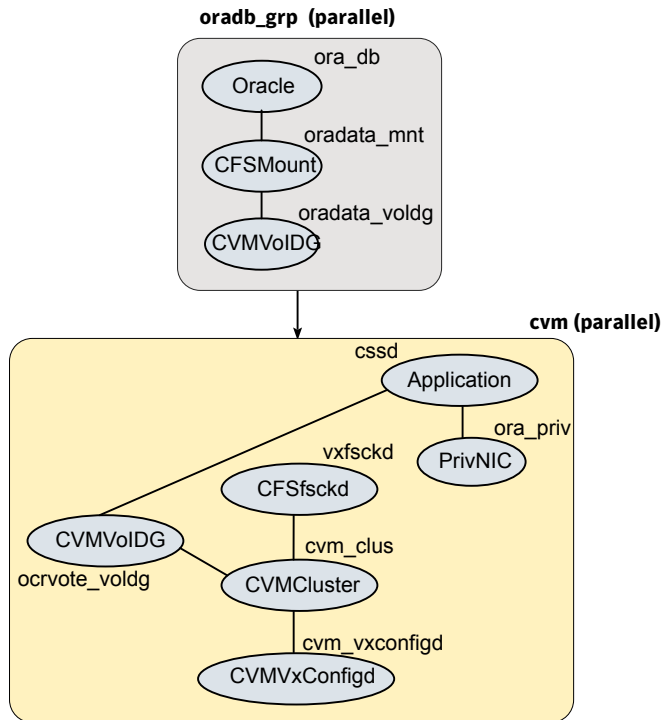

## sfrac03\_main.cf file

This sample file describes the following configuration:

- A two node SF Oracle RAC cluster hosting two databases.
- The Oracle database is stored on CFS.
- The database is managed by the VCS agent for Oracle. The agent starts, stops, and monitors the database.
- The database uses the Oracle UDP IPC for database cache fusion.
- One IP address (on lan1) is shared by Oracle Clusterware and one of the databases for cache fusion. The second IP address (on lan2) is used by the second database for cache fusion. The private IP addresses are managed by the MultiPrivNIC agent for high availability.
- The Oracle Cluster Registry (OCR) and voting disk are stored on CFS.



Figure D-3 illustrates the configuration.

**Figure D-3** Service group configuration for sfrac03\_main.cf file

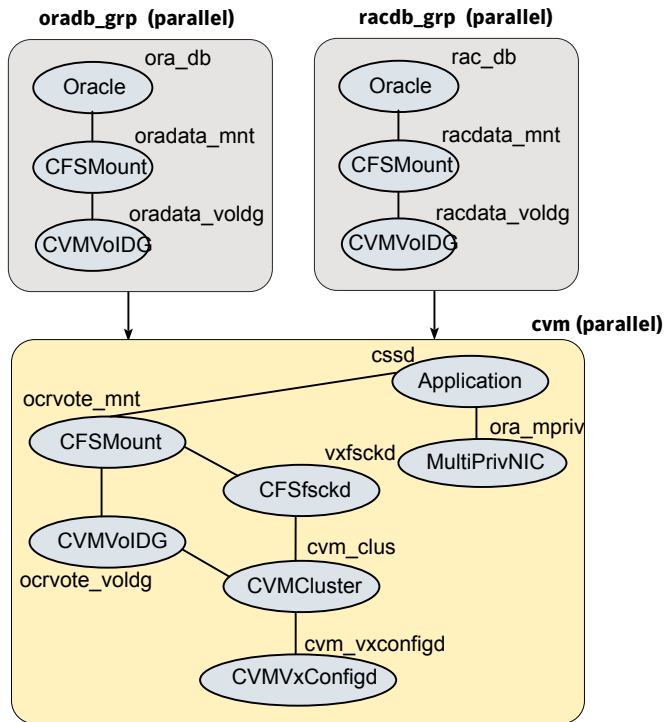

## sfrac04\_main.cf file

This sample file describes the following configuration:

- A two node SF Oracle RAC cluster hosting two databases.
- The Oracle database is stored on CFS.
- Database is not managed by VCS. Oracle Clusterware starts, stops, and monitors the databases.

The CRSResource agent monitors the status of the database, the VIP resource, and the listener resource configured under Oracle Clusterware.

---

**Note:** The CFSSMount and CVMVolDg resources for Oracle database can not be set as critical resources in the group.

The CRSResource agent appears FAULTED until Oracle Clusterware brings up the database.

---

- The database uses the Oracle UDP IPC for database cache fusion.
- One IP address (on lan1) is shared by Oracle Clusterware and one of the databases for cache fusion.  
The second IP address (on lan2) is used by the second database for cache fusion.  
The private IP addresses are managed by the MultiPrivNIC agent for high availability.
- The Oracle Cluster Registry (OCR) and voting disk are stored on CFS.

[Figure D-4](#) illustrates the configuration.

**Figure D-4** Service group configuration for sfrac04\_main.cf file

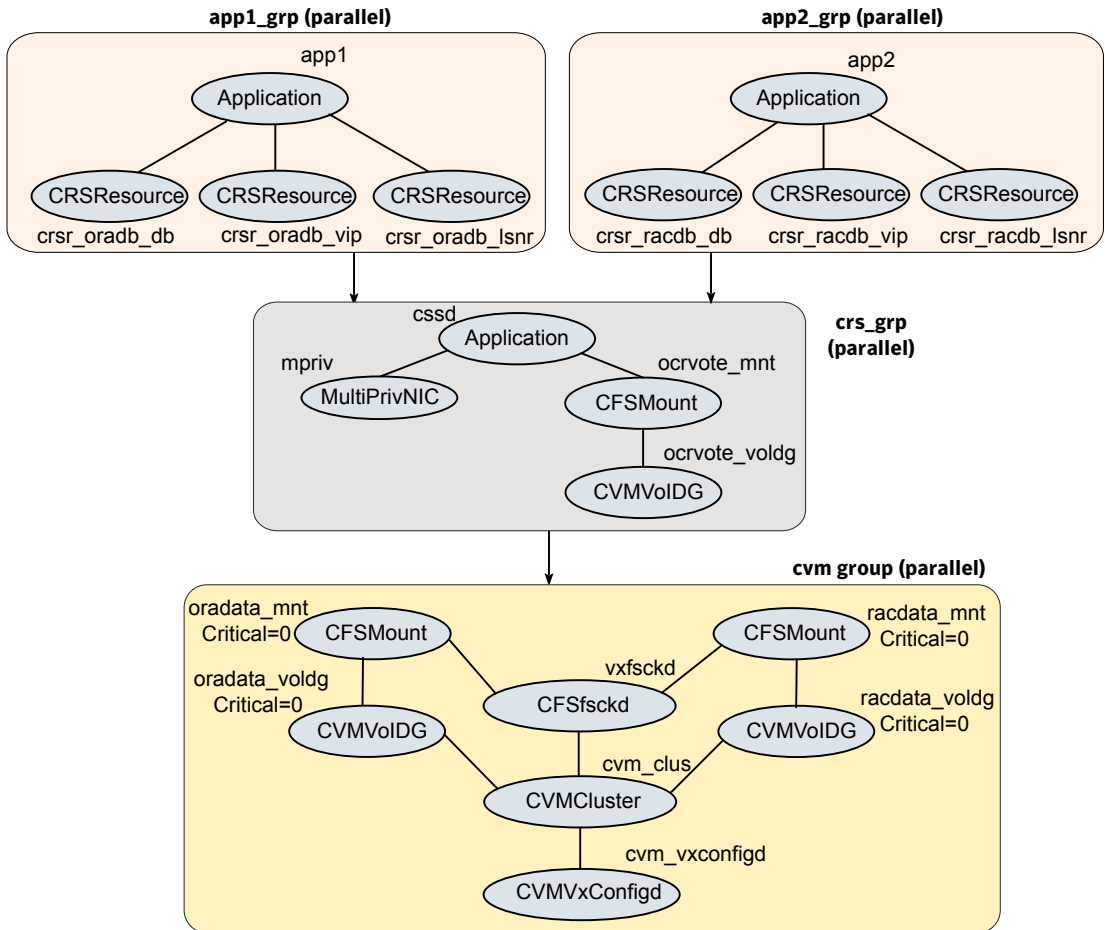

## sfrac05\_main.cf file

This sample file describes the following configuration:

- A two node SF Oracle RAC cluster hosting single database.
- The Oracle database is stored on ASM.
- The database is managed by the VCS agent for Oracle.  
The agent starts, stops, and monitors the database.
- The database uses the Oracle UDP IPC for database cache fusion.

- A common IP address is used by Oracle Clusterware and database cache fusion. The private IP address is managed by the PrivNIC agent for high availability.
- The Oracle Cluster Registry (OCR) and voting disk are stored on CFS.

Figure D-5 illustrates the configuration.

**Figure D-5** Service group configuration for sfrac05\_main.cf file

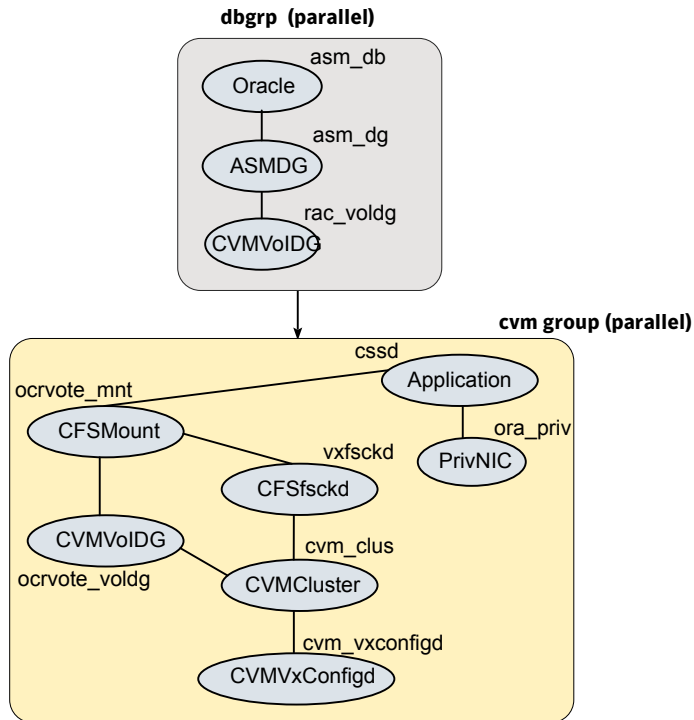

## sfrac06\_main.cf file

This sample file describes the following configuration:

- A two node SF Oracle RAC cluster hosting two databases.
- The Oracle database is stored on CFS.
- The database is managed by the VCS agent for Oracle. The agent starts, stops, and monitors the database.
- The database uses Oracle UDP IPC for cache fusion. A dedicated link is used for each database .
- One private IP address (on lan1) is used by Oracle Clusterware.

The private IP address on lan2 is used by one of the databases for cache fusion. The private IP address on NIC3 is used by the other database for cache fusion. The private IP addresses are managed by the MultiPrivNIC agent for high availability.

- The Oracle Cluster Registry (OCR) and voting disk are stored on CFS.

Figure D-6 illustrates the configuration.

**Figure D-6** Service group configuration for sfrac06\_main.cf file

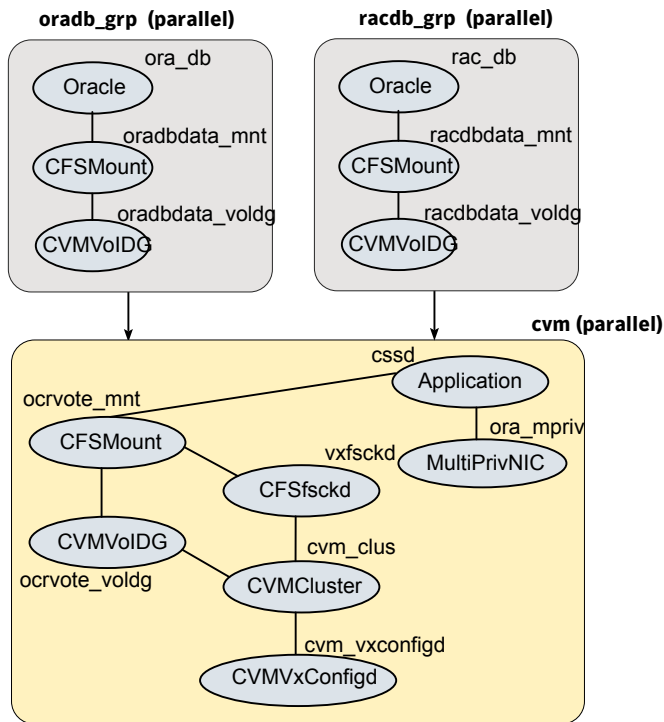

## sfrac07\_main.cf and sfrac08\_main.cf files

The sample configuration, `sfrac07_main.cf`, describes a disaster recovery configuration for the primary site. The sample configuration, `sfrac08_main.cf`, describes a disaster recovery configuration for the secondary site. The configuration uses VVR for replicating data between the sites.

This sample file describes the following configuration:

- Two SF Oracle RAC clusters, comprising two nodes each, hosted at different geographical locations.

- A single Oracle database that is stored on CFS.
- The database is managed by the VCS agent for Oracle. The agent starts, stops, and monitors the database.
- The database uses the Oracle UDP IPC for database cache fusion.
- A common IP address is used by Oracle Clusterware and database cache fusion. The private IP address is managed by the PrivNIC agent for high availability.
- One virtual IP address must be configured under the `ClusterService` group on each site for inter-cluster communication.
- The Oracle Cluster Registry (OCR) and voting disk are stored on CFS.
- Veritas Volume Replicator (VVR) is used to replicate data between the sites.
- The shared volumes replicated across the sites are configured under the RVG group.
- The replication link used by VVR for communicating log information between sites are configured under the `rlogowner` group. This is a failover group that will be online on only one of the nodes in the cluster at each site.
- The database group will be online on the primary cluster. The `RVGSharedPri` resource determines where the database group will be brought online.
- The database group is configured as a global group by specifying the clusters on the primary and secondary sites as values for the `ClusterList` group attribute.

Figure D-7 illustrates the configuration. The service group configuration is the same on the primary and secondary site. The availability of groups (online/offline) differ between the sites.

**Figure D-7** Service group configuration for sfrac07\_main.cf and sfrac08\_main.cf files

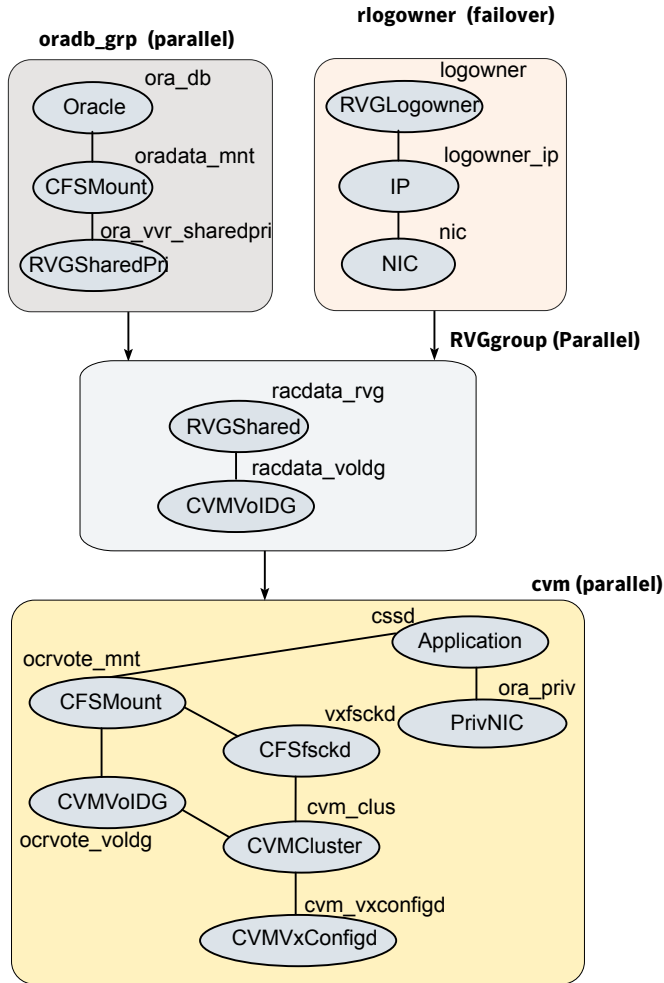

## sfrac09\_main.cf and sfrac10\_main.cf files

The sample configuration, sfrac09\_main.cf, describes a disaster recovery configuration for the primary site. The sample configuration, sfrac10\_main.cf, describes a disaster recovery configuration for the secondary site. The sample configuration uses EMC SRDF technology for replicating data between the sites.

---

**Note:** You can use other supported hardware-based replication technologies with this configuration.

---

This sample file describes the following configuration:

- Two SF Oracle RAC clusters, comprising two nodes each, hosted at different geographical locations.
- A single Oracle database that is stored on CFS.
- The database is managed by the VCS agent for Oracle. The agent starts, stops, and monitors the database.
- The database uses the Oracle UDP IPC for database cache fusion.
- A common IP address is used by Oracle Clusterware and database cache fusion. The private IP address is managed by the PrivNIC agent for high availability.
- One virtual IP address must be configured under the `ClusterService` group on each site for inter-cluster communication.
- The Oracle Cluster Registry (OCR) and voting disk are stored on CFS.
- EMC SRDF is used to replicate data between the sites.
- The SRDF disk groups that are replicated across the sites using SRDF technology and the replication mode are specified under the SRDF resource in the database group. The CVM disk group that comprises the SRDF disk group must be configured under the `CVMVolDg` resource in the database group.
- The database group will be online on the primary cluster. The SRDF resource determines where the database group will be brought online.
- The database group is configured as a global group by specifying the clusters on the primary and secondary sites as values for the `ClusterList` group attribute.

[Figure D-8](#) illustrates the configuration on the primary site.



**Figure D-8** Service group configuration for sfrac09\_main.cf file

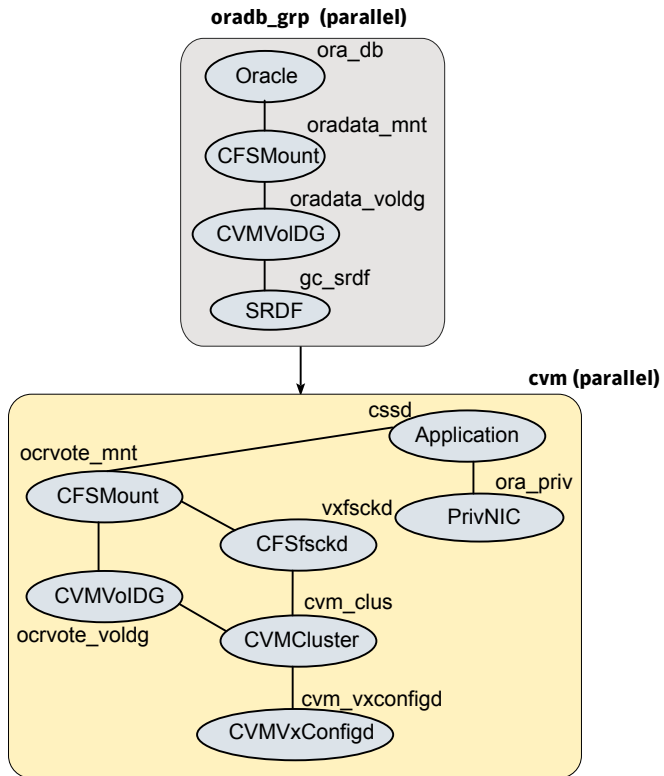
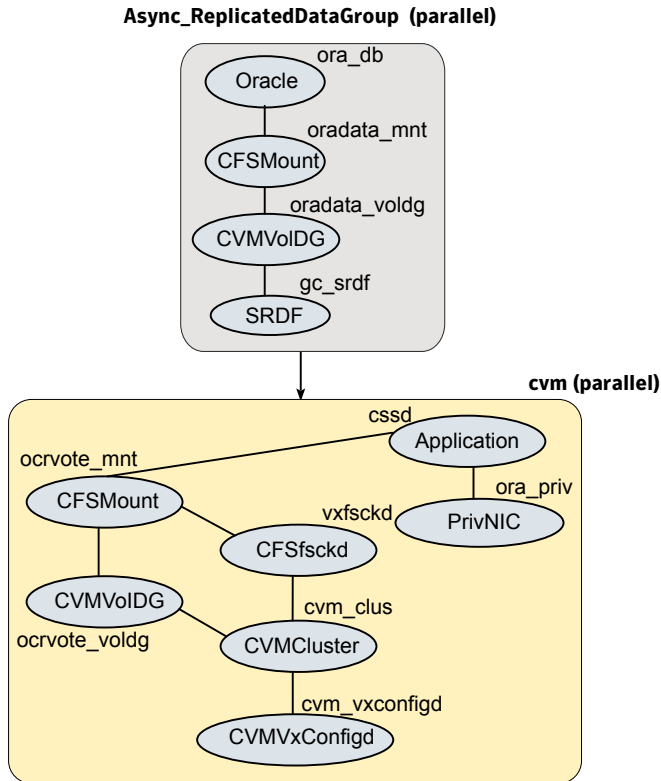

Figure D-9 illustrates the configuration on the secondary site.

**Figure D-9** Service group configuration for sfrac10\_main.cf file



## sfrac11\_main.cf file

This sample file describes the following configuration:

- An SF Oracle RAC campus cluster with four nodes hosted across two sites.
- Each site comprises two nodes of the cluster hosting a single database.
- The Oracle database is stored on CFS.
- The database is managed by the VCS agent for Oracle. The agent starts, stops, and monitors the database.
- The database uses the Oracle UDP IPC for database cache fusion.
- The IP address on lan1 is used by Oracle Clusterware. The second IP address on NIC2 is used for Oracle database cache fusion.

The private IP addresses are managed by the MultiPrivNIC agent for high availability.

- The Oracle Cluster Registry (OCR) and voting disk are stored on CFS.
- Group the hosts at each physical site into separate logical system zones using the SystemZones attribute.

Figure D-10 illustrates the configuration.

**Figure D-10** Service group configuration for sfrac11\_main.cf file

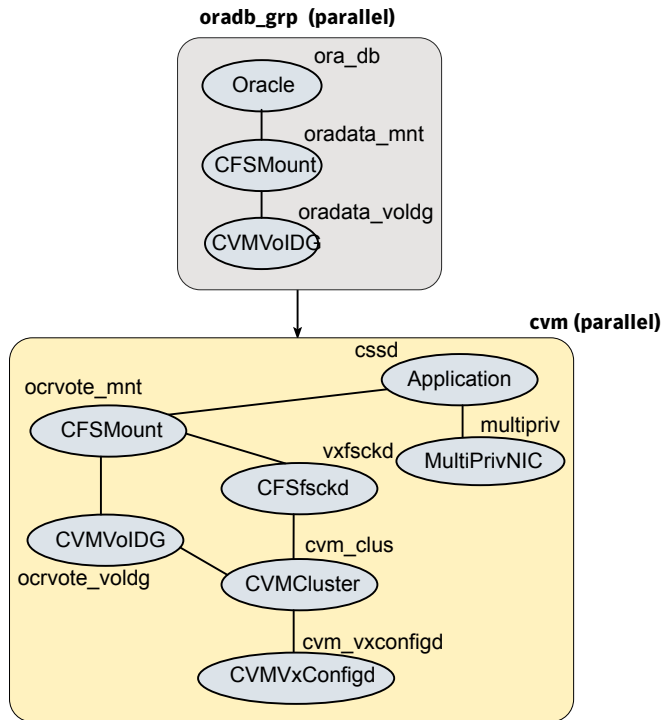

## sfrac12\_main.cf and sfrac13\_main.cf files

The sample configuration, sfrac12\_main.cf, describes a disaster recovery configuration for the primary site. The sample configuration, sfrac13\_main.cf, describes a disaster recovery configuration for the secondary site with fire-drill capability. The sample configuration uses Hitachi True Copy technology for replicating data between the sites.

---

**Note:** You can use other supported hardware-based replication technologies with this configuration.

---

This sample file describes the following configuration:

- Two SF Oracle RAC clusters, comprising two nodes each, hosted at different geographical locations.
- A single Oracle database that is stored on CFS.
- The database is managed by the VCS agent for Oracle. The agent starts, stops, and monitors the database.
- The database uses the Oracle UDP IPC for database cache fusion.
- A common IP address is used by Oracle Clusterware and database cache fusion. The private IP address is managed by the PrivNIC agent for high availability.
- One virtual IP address must be configured under the `ClusterService` group on each site for inter-cluster communication.
- The Oracle Cluster Registry (OCR) and voting disk are stored on CFS.
- Hitachi True Copy is used to replicate data between the sites.
- The HTC disk groups that are replicated across the sites using HTC technology and the replication mode are specified under the HTC resource in the database group. The CVM disk group that comprises the HTC disk group must be configured under the CVMVolDg resource in the database group.
- The database group will be online on the primary cluster. The HTC resource determines where the database group will be brought online.
- The database group is configured as a global group by specifying the clusters on the primary and secondary sites as values for the `ClusterList` group attribute.
- The database group `oradb_grp_fd` on the secondary is configured for fire drill.
- When the group `oradb_grp_fd` is brought online, the HTCSnap creates a snapshot of the disk group configured under the HTC resource in the database group `oradg_grp`.  
Further, the Oracle database and the associated volumes and mount points configured under the service group `oradb_grp_fd` are brought online using the snapshots created by HTCSnap.

Figure D-11 illustrates the configuration on the primary site.

**Figure D-11** Service group configuration for sfrac12\_main.cf file

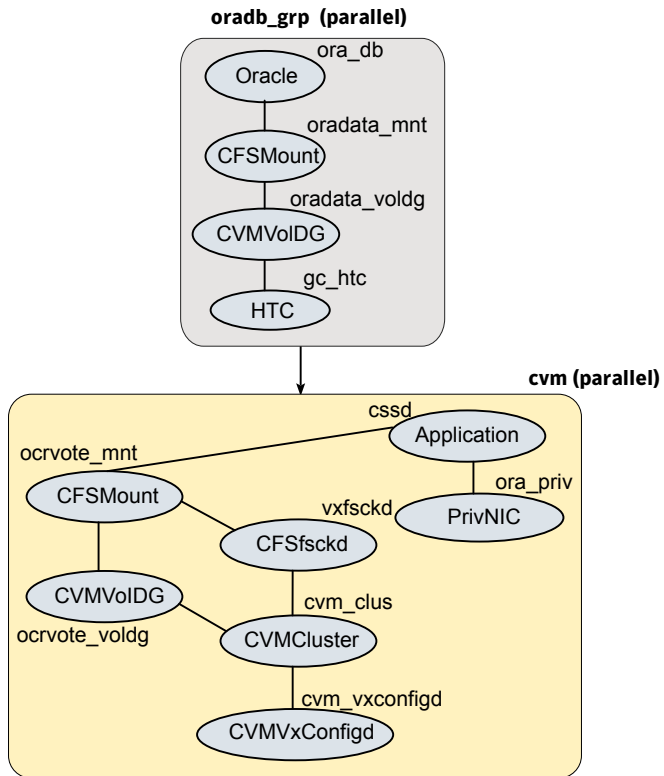

**Figure D-12** illustrates the configuration on the secondary site.

**Figure D-12** Service group configuration for sfrac13\_main.cf file

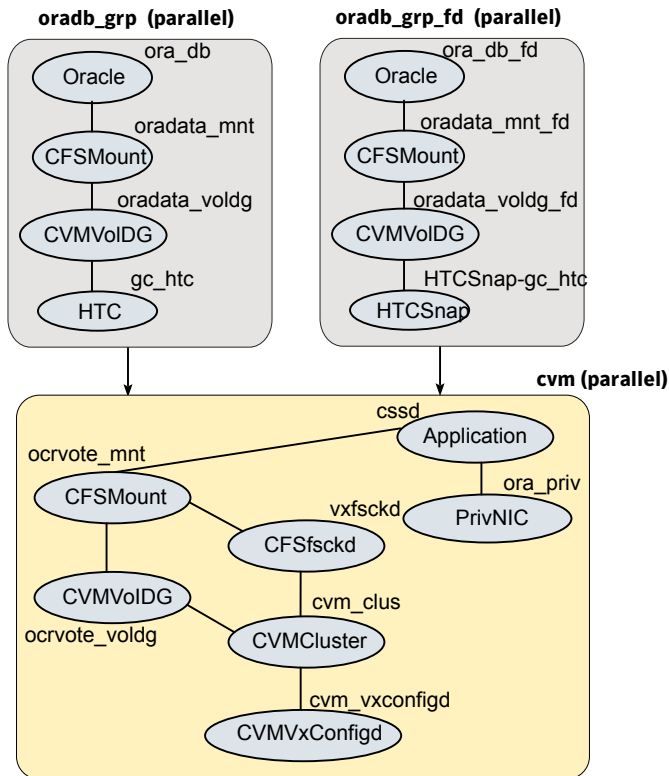

## sfrac14\_main.cf file

This sample file describes the following configuration:

- A two node SF Oracle RAC cluster hosting single database.
- The Oracle database is stored on CFS.
- The database is managed by the VCS agent for Oracle. The agent starts, stops, and monitors the database.
- The database uses the Oracle UDP IPC for database cache fusion.
- A common IP address is used by Oracle Clusterware and database cache fusion. The private IP address is managed by the PrivNIC agent for high availability.
- The Oracle Cluster Registry (OCR) and voting disk are stored on CFS.

Figure D-13 illustrates the configuration.

**Figure D-13** Service group configuration for sfrac14\_main.cf file

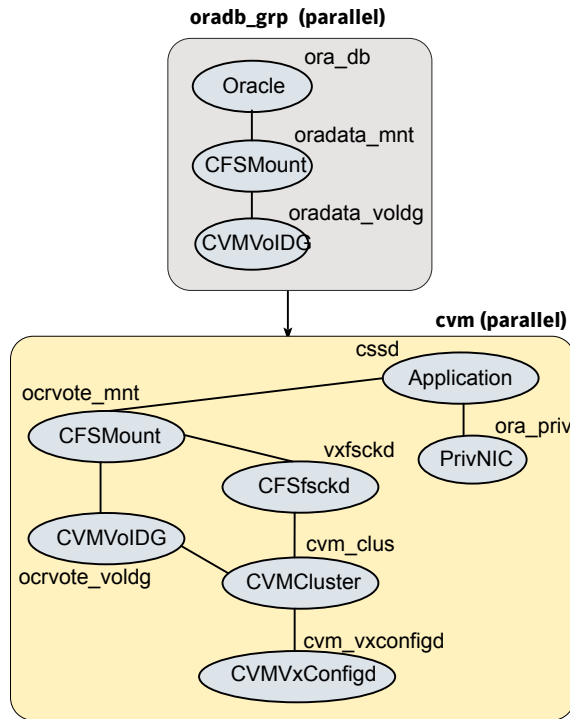

## Sample configuration files for CP server

The `/etc/vxcps.conf` file determines the configuration of the coordination point server (CP server.)

See “[Sample CP server configuration \(/etc/vxcps.conf\) file output](#)” on page 581.

The following are example main.cf files for a CP server that is hosted on a single node, and a CP server that is hosted on an SFHA cluster.

- The main.cf file for a CP server that is hosted on a single node:  
 See “[Sample main.cf file for CP server hosted on a single node that runs VCS](#)” on page 576.
- The main.cf file for a CP server that is hosted on an SFHA cluster:  
 See “[Sample main.cf file for CP server hosted on a two-node SFHA cluster](#)” on page 578.

---

**Note:** The CP server supports Internet Protocol version 4 (IPv4 addresses) when communicating with SF Oracle RAC clusters (application clusters). The example main.cf files use IPv4 addresses.

---

## Sample main.cf file for CP server hosted on a single node that runs VCS

The following is an example of a single CP server node main.cf.

For this CP server single node main.cf, note the following values:

- Cluster name: cps1
- Node name: cps1

```
include "types.cf"
include "/opt/VRTScps/bin/Quorum/QuorumTypes.cf"

// cluster name: cps1
// CP server: cps1

cluster cps1 (
 UserNames = { admin = bMNFmHmJNiNNlVnHMK, haris = fopKojNvpHouNn,
 "cps1.symantecexample.com@root@vx" = aj,
 "root@cps1.symantecexample.com" = hq }
 Administrators = { admin, haris,
 "cps1.symantecexample.com@root@vx",
 "root@cps1.symantecexample.com" }
 SecureClus = 1
 HacliUserLevel = COMMANDROOT
)

system cps1 (
)

group CPSSG (
 SystemList = { cps1 = 0 }
 AutoStartList = { cps1 }
)

IP cpsvip1 (
 Critical = 0
 Device @cps1 = lan0
 Address = "10.209.3.1"
 NetMask = "255.255.252.0"
```



```
)

IP cpsvip2 (
 Critical = 0
 Device @cps1 = lan1
 Address = "10.209.3.2"
 NetMask = "255.255.252.0"
)

NIC cpsnic1 (
 Critical = 0
 Device @cps1 = lan0
 PingOptimize = 0
 NetworkHosts @cps1 = { "10.209.3.10 }
)

NIC cpsnic2 (
 Critical = 0
 Device @cps1 = lan1
 PingOptimize = 0
)

Process vxcperv (
 PathName = "/opt/VRTScps/bin/vxcperv"
 ConfInterval = 30
 RestartLimit = 3
)

Quorum quorum (
 QuorumResources = { cpsvip1, cpsvip2 }
)

cpsvip1 requires cpsnic1
cpsvip2 requires cpsnic2
vxcperv requires quorum

// resource dependency tree
//
// group CPSSG
// {
// IP cpsvip1
// {
```

```
// NIC cpsnic1
// }
// IP cpsvip2
// {
// NIC cpsnic2
// }
// Process vxcperv
// {
// Quorum quorum
// }
// }
```

## Sample main.cf file for CP server hosted on a two-node SFHA cluster

The following is an example of a main.cf, where the CP server is hosted on an SFHA cluster.

For this CP server hosted on an SFHA cluster main.cf, note the following values:

- Cluster name: cps1
- Nodes in the cluster: cps1, cps2

```
include "types.cf"
include "CFSTypes.cf"
include "CVMTTypes.cf"
include "/opt/VRTScps/bin/Quorum/QuorumTypes.cf"

// cluster: cps1
// CP servers:
// cps1
// cps2

cluster cps1 (
 UserNames = { admin = ajkCjeJgkFkkIskEjh,
 "cps1.symantecexample.com@root@vx" = JK,
 "cps2.symantecexample.com@root@vx" = dl }
 Administrators = { admin, "cps1.symantecexample.com@root@vx",
 "cps2.symantecexample.com@root@vx" }
 SecureClus = 1
)

system cps1 (
```

```
)

system cps2 (
)

group CPSSG (
 SystemList = { cps1 = 0, cps2 = 1 }
 AutoStartList = { cps1, cps2 })

 DiskGroup cpsdg (
 DiskGroup = cps_dg
)

 IP cpsvip1 (
 Critical = 0
 Device @cps1 = lan0
 Device @cps2 = lan0
 Address = "10.209.81.88"
 NetMask = "255.255.252.0"
)

 IP cpsvip2 (
 Critical = 0
 Device @cps1 = lan1
 Device @cps2 = lan1
 Address = "10.209.81.89"
 NetMask = "255.255.252.0"
)

 Mount cpsmount (
 MountPoint = "/etc/VRTScps/db"
 BlockDevice = "/dev/vx/dsk/cps_dg/cps_volume"
 FSType = vxfs
 FsckOpt = "-y"
)

 NIC cpsnic1 (
 Critical = 0
 Device @cps1 = lan0
 Device @cps2 = lan0
 PingOptimize = 0
 NetworkHosts @cps1 = { "10.209.81.10 }
)
```

```
NIC cpsnic2 (
 Critical = 0
 Device @cps1 = lan1
 Device @cps2 = lan1
 PingOptimize = 0
)

Process vxcperv (
 PathName = "/opt/VRTScps/bin/vxcperv"
)

Quorum quorum (
 QuorumResources = { cpsvip1, cpsvip2 }
)

Volume cpsvol (
 Volume = cps_volume
 DiskGroup = cps_dg
)

cpismount requires cpsvol
cpsvip1 requires cpsnic1
cpsvip2 requires cpsnic2
cpsvol requires cpsdg
vxcperv requires cpismount
vxcperv requires quorum

// resource dependency tree
//
// group CPSSG
// {
// IP cpsvip1
// {
// NIC cpsnic1
// }
// IP cpsvip2
// {
// NIC cpsnic2
// }
// Process vxcperv
// {
```

```
// Quorum quorum
// Mount cpsmount
// {
// Volume cpsvol
// {
// DiskGroup cpsdg
// }
// }
// }
```

## Sample CP server configuration (/etc/vxcps.conf) file output

The following is an example of a coordination point server (CP server) configuration file `/etc/vxcps.conf` output.

```
The vxcps.conf file determines the
configuration for Veritas CP Server.
cps_name=cps1
vip=[10.209.81.88]
vip=[10.209.81.89]:56789
port=14250
security=1
db=/etc/VRTScps/db
```

# Setting up inter-system communication

This appendix includes the following topics:

- [About using ssh or remsh with the Veritas installer](#)
- [Setting up inter-system communication](#)

## About using ssh or remsh with the Veritas installer

The installer uses passwordless secure shell (`ssh`) or remote shell (`remsh`) communications among systems. The installer uses the `ssh` or `remsh` daemon that comes bundled with the operating system. During an installation, you choose the communication method that you want to use. You then provide the installer with the superuser passwords for the systems where you plan to install. Note that for security reasons, the installation program neither stores nor caches these passwords. The `ssh` or `remsh` communication among the systems is removed when the installation process completes, unless the installation abruptly terminates. If installation terminated abruptly, use the installation script's `-comcleanup` option to remove the `ssh` or `remsh` configuration from the systems.

In most installation, configuration, upgrade (where necessary), and uninstallation scenarios, the installer can configure `ssh` or `remsh` on the target systems. In the following scenarios, you need to set up `ssh` or `remsh` manually:

- When the root broker is outside of the cluster that you plan to configure.
- When you add new nodes to an existing cluster.
- When the nodes are in a subcluster during a phased upgrade.
- When you perform installer sessions using a response file.

# Setting up inter-system communication

If you manually need to set up a communication mode, refer to these procedures. You must have root privilege to issue ssh or remsh commands on all systems in the cluster. If ssh is used to communicate between systems, it must be configured in a way such that it operates without requests for passwords or passphrases. Similarly, remsh must be configured in such a way to not prompt for passwords.

If system communication is not possible between systems using ssh or remsh, contact Symantec Support. See <http://support.symantec.com>.

## Setting up ssh on cluster systems

Use the Secure Shell (ssh) to install SF Oracle RAC on all systems in a cluster from a system outside of the cluster. Before you start the installation process, verify that ssh is configured correctly.

Use Secure Shell (ssh) to do the following:

- Log on to another system over a network
- Execute commands on a remote system
- Copy files from one system to another

The ssh shell provides strong authentication and secure communications over channels. It is intended to replace rlogin, remsh, and rcp.

## Configuring ssh

The procedure to configure ssh uses OpenSSH example file names and commands.

---

**Note:** You can configure ssh in other ways. Regardless of how ssh is configured, complete the last step in the example to verify the configuration.

---

### To configure ssh

- 1 Log on to the system from which you want to install SF Oracle RAC.
- 2 Generate a DSA key pair on this system by running the following command:

```
ssh-keygen -t dsa
```

- 3 Accept the default location of `~/.ssh/id_dsa`.
- 4 When the command prompts, enter a passphrase and confirm it.

- 5 Change the permissions of the `.ssh` directory by typing:

```
chmod 755 ~/.ssh
```

- 6 The file `~/.ssh/id_dsa.pub` contains a line that begins with `ssh_dss` and ends with the name of the system on which it was created. Copy this line to the `/.ssh/authorized_keys` file on all systems where you plan to install SF Oracle RAC.

If the local system is part of the cluster, make sure to edit the `authorized_keys` file on that system.

- 7 Run the following commands on the system where you are installing:

```
exec /usr/bin/ssh-agent $SHELL
ssh-add
```

This step is shell-specific and is valid for the duration the shell is alive.

- 8 When the command prompts, enter your DSA passphrase.

You are ready to install VCS on several systems in one of the following ways:

- Run the `installvcs` program on any one of the systems
- Run the `installvcs` program on an independent system outside the cluster

- 9 To verify that you can connect to the systems where you plan to install SF Oracle RAC, type:

```
ssh -x -l root north ls
ssh -x -l root south /usr/sbin/ifconfig lan0
```

The commands should execute on the remote system without having to enter a passphrase or password.



# Automatic Storage Management

This appendix includes the following topics:

- [About ASM in SF Oracle RAC environments](#)
- [ASM configuration with SF Oracle RAC](#)
- [Configuring ASM in SF Oracle RAC environments](#)
- [Sample configuration file Veritas CVM and ASM main.cf file](#)

## About ASM in SF Oracle RAC environments

ASM is an integrated storage management solution from Oracle RAC that combines file system and volume management capabilities.

ASM can be configured with Cluster Volume Manager (CVM) for better performance and availability. CVM mirrored volumes with dynamic multi-pathing improves data access performance and offers continuous data availability in large heterogeneous SAN environments. You can create CVM disk groups and volumes for use as ASM disks groups and configure the ASM disk groups to be managed by the Veritas ASMDG agent. The ASMDG agent mounts, unmounts, and monitors the ASM disk groups.

Depending on the Oracle RAC version installed, the following are supported on ASM for that version:

|                                                   |                                                                                  |
|---------------------------------------------------|----------------------------------------------------------------------------------|
| Oracle RAC 10g Release 2/Oracle RAC 11g Release 1 | Data files, control files, online redo logs, archive log files, and backup files |
|---------------------------------------------------|----------------------------------------------------------------------------------|

Oracle RAC 11g Release 2      Oracle Cluster Registry devices (OCR), voting disk, data files, control files, online redo logs, archive log files, and backup files

Depending on the Oracle RAC version installed, the following are not supported on ASM for that version:

Oracle RAC 10g Release 2/Oracle RAC 11g Release 1      Oracle binaries, trace files, alert logs, export files, tar files, core files, Oracle Cluster Registry devices (OCR), voting disk, application binaries and application data

Oracle RAC 11g Release 2      Oracle binaries, trace files, alert logs, export files, tar files, core files, application binaries and application data

## ASM configuration with SF Oracle RAC

Configure ASM disk groups over CVM volumes in SF Oracle RAC environments. The CVM volumes are mirrored for high availability of data and leverage Dynamic Multi-Pathing to access the shared storage.

[Figure F-1](#) illustrates the configuration of ASM disk groups over CVM.

**Figure F-1**      ASM disk groups over CVM

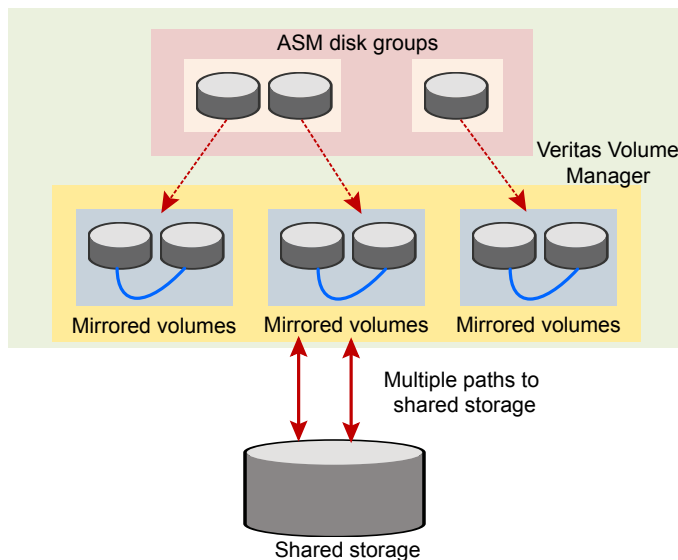

Figure F-2 illustrates the following supported configuration for all supported versions of Oracle RAC:

- ASM disk groups configured over CVM volumes
- Oracle Clusterware and database binaries stored locally
- Oracle database files stored on ASM configured over CVM  
The Oracle databases are managed by Oracle Clusterware.
- Oracle Cluster Registry and voting disk stored on CFS

Figure F-2 Supported Oracle RAC configuration (all supported Oracle RAC versions)

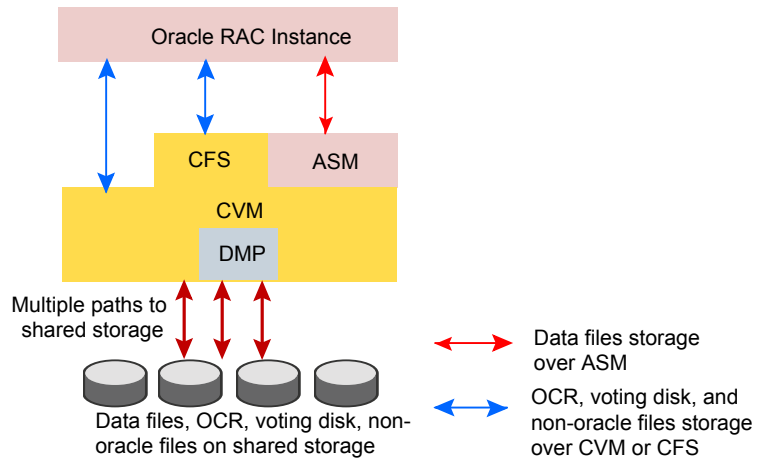
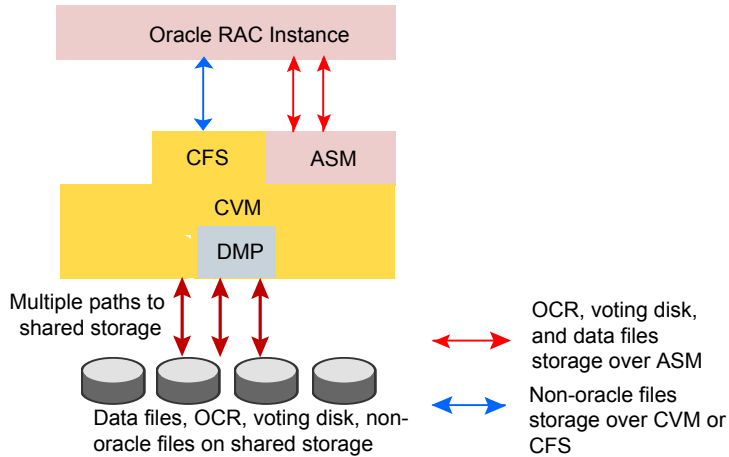

Figure F-3 illustrates the following supported configuration for Oracle RAC 11g Release 2:

- ASM disk groups configured over CVM volumes
- Oracle Clusterware and database binaries stored locally
- Oracle database files stored on ASM configured over CVM  
The Oracle databases are managed by Oracle Clusterware.
- Oracle Cluster Registry and voting disk stored on ASM over CVM volumes

**Figure F-3** Supported Oracle RAC configuration (Oracle RAC 11g Release 2)



## Configuring ASM in SF Oracle RAC environments

Before you configure ASM, review the planning guidelines for ASM:

See [“Planning for Oracle ASM over CVM”](#) on page 56.

---

**Note:** Make sure that you have installed SF Oracle RAC and Oracle RAC before configuring ASM.

---

Depending on the Oracle RAC version, the ASM home directory varies as follows:

Oracle RAC 10g Release 2/Oracle RAC 11g Release 1

Use a home directory distinct from the ORACLE\_HOME directory.

Oracle RAC 11g Release 2

The ASM home directory is the same as the Oracle Grid Infrastructure home directory (GRID\_HOME).

### To configure ASM in SF Oracle RAC installations

- 1 Set up ASM.  
See [“Setting up Automatic Storage Management”](#) on page 589.
- 2 For Oracle RAC 10g Release 2/Oracle RAC 11g Release 1: In the ASM home directory, relink the Oracle libraries with Veritas libraries.

---

**Note:** When the SF Oracle RAC installer prompts you for the path to the ORACLE\_HOME directory, make sure to enter the path to the ASM\_HOME directory, which is distinct from the Oracle home directory.

---

See [“Relinking the SF Oracle RAC libraries with Oracle RAC”](#) on page 327.

- 3 For Oracle RAC 10g Release 2/Oracle RAC 11g Release 1: Unlink the Veritas ODM library from the ASM home directory.  
For Oracle RAC 11g Release 2:  
Unlink the Veritas ODM library from the ORACLE\_HOME directory.  
See [“Unlinking the SF Oracle RAC ODM library”](#) on page 591.
- 4 Create the required database storage on ASM by creating CVM disk groups and volumes for use as ASM disks.  
See [“Creating database storage on ASM”](#) on page 592.
- 5 Create ASM disk groups and instances.  
See [“Creating ASM disk groups and instances”](#) on page 593.
- 6 Verify the ASM setup.  
See [“Verifying the ASM setup”](#) on page 594.
- 7 Create the Oracle database. For instructions, see the Oracle RAC documentation.
- 8 Configure VCS service groups for the Oracle database.  
See [“Configuring VCS service groups for database instances on ASM”](#) on page 594.

## Setting up Automatic Storage Management

Perform this step only for Oracle RAC 10g Release 2 or Oracle RAC 11g Release 1 installations.

Set up ASM in a directory distinct from the Oracle database home (ORACLE\_HOME) directory. A separate ASM home directory enables you to upgrade or uninstall the software independent of the Oracle database home.

The following procedure describes how to set up ASM using the Oracle Universal Installer. Symantec recommends that you set up ASM locally on each node.

### To set up ASM using the Oracle Universal Installer

- 1 Log in as the Oracle user. On the first node, set the DISPLAY variable.

- For Bourne Shell (bash), type:

```
$ DISPLAY=10.20.12.150:0.0 export DISPLAY
```

- For C Shell (csh or tcsh), type:

```
$ setenv DISPLAY 10.20.12.150:0.0
```

- 2 Start the Oracle Universal Installer.

```
$ cd /dvd_mount
```

```
$./runInstaller
```

- 3 Enter the following information when prompted by the Oracle Universal Installer:

Select installation type

Select **Enterprise Edition**.

Specify home details

Enter the full path of the ASM home directory.

**Note:** Oracle recommends that the ASM home directory be different from the ORACLE\_HOME directory used for installing the Oracle database.

Oracle Home location: The installation destination (\$ORACLE\_HOME). Depending on where you install Oracle binaries, this location is either on shared storage or an identical location on each of the local cluster nodes.

Specify Hardware Cluster Installation Mode

Select **Cluster Installation**.

Select the nodes on which you want to install the Oracle RAC database software.

- 4 Click **Next**.

The Oracle Universal Installer runs a product-specific prerequisite check. Any items that are flagged must be manually checked and configured.

- 5 On the **Select Configuration Option** screen, select the option **Install database software only**.

---

**Note:** Do not select the option **Configure Automatic Storage Management (ASM)**. Symantec recommends that you configure ASM later.

---

- 6 Review the configuration summary presented by the Oracle Universal Installer. The Oracle Universal Installer begins the installation.
- 7 Run the root.sh script as prompted by the Oracle Universal Installer.

## Unlinking the SF Oracle RAC ODM library

ODM is a disk management interface for data files that reside on the Veritas File system.

You need to unlink the ODM library from the ORACLE\_HOME directory for ASM before you configure the database storage on ASM with SF Oracle RAC.

For Oracle RAC 10g Release 2/Oracle RAC 11g Release 1, the Oracle home directory for ASM is separate from the ORACLE\_HOME directory.

For Oracle RAC 11g Release 2, the Oracle home directory for ASM is the same as the GRID\_HOME directory.

---

**Note:** Depending on the Oracle version installed, provide the appropriate path for \$ORACLE\_HOME.

---

Perform the steps in the procedure on each node in the cluster.

### To unlink the Veritas ODM library

- 1 Log in as the Oracle user.
- 2 Shut down the ASM instance if it is running:

```
$ srvctl stop asm -n sys1
```

```
$ srvctl stop asm -n sys2
```

- 3 Change to the Oracle home directory for ASM:

```
$ cd $ORACLE_HOME/lib
```

- 4 Unlink the Veritas ODM libraries:

For Oracle RAC 10g:

```
$ ln -sf libodmd10.so libodm10.so
```

For Oracle RAC 11g:

```
$ ln -sf libodmd11.so libodm11.so
```

## Creating database storage on ASM

This step creates the database storage on ASM using CVM volumes. To create the storage for Oracle databases on ASM, first create the required CVM disk groups and volumes. Then, use these CVM volumes to create ASM disk groups for storing the database files.

### To create database storage on ASM

- 1 Log in as the root user to the CVM master:

To determine the CVM master:

```
vxdctl -c mode
```

- 2 Initialize the disks as VxVM disks:

```
vxdisksetup -i c1t1d0
```

- 3 Set the activation mode for the disk group on all nodes:

```
vxdg -g ora_asm_dg set activation=sw
```

- 4 Create the CVM disk group and volume:

```
vxdg -s init ora_asm_dg c1t1d0
```

```
vxassist -g ora_asm_dg make ora_asm_vol 2000M
```

- 5 Set the permissions for the Oracle user on the volume:

```
vxedit -g ora_asm_dg \
set group=dba user=oracle mode=660 ora_asm_vol
```



Configure ASM using DBCA (Oracle RAC 10g Release 2/Oracle RAC 11g Release 1), ASMCA (Oracle RAC 11g Release 2), or OEM.

## Creating ASM disk groups and instances

Depending on the Oracle RAC version, use one of the following ways to create ASM disk groups:

|                                                   |                                                                                      |
|---------------------------------------------------|--------------------------------------------------------------------------------------|
| Oracle RAC 10g Release 2/Oracle RAC 11g Release 1 | Database Configuration Assistant (DBCA)<br>Oracle Enterprise Manager (OEM)<br>Manual |
| Oracle RAC 10g Release 2                          | ASM Configuration Assistant (ASMCA)<br>Manual                                        |

The following tasks are performed:

- The ASM disk group and instance is created.
- The ASM instance is started and the disk group is mounted on all nodes in the cluster. The default ASM instance name is +ASM $n$  where  $n$  is the instance number depending on the number of ASM instances.

---

**Note:** For ASM instances that use a pfile, if you restart a node, make sure that the underlying volumes are available before the ASM disk group is mounted. Then, update the ASM init.ora parameter with the full path that contains the VxVM volumes created for ASM.

For ASM instances that use an spfile, the parameter is updated automatically by the Oracle Configuration Assistant.

In either case, dependencies must be managed manually. Symantec recommends the use of the ASMDG agent for easier management of ASM disk groups.

---

SF Oracle RAC requires the following settings when you create ASM disk groups and instances:

Type of parameter file for the server parameter file (spfile)  
ASM instance

Disk Discovery Path                      Enter the full path that contains the VxVM volumes created for ASM, for example  
`/dev/vx/rdisk/ora_asm_dg/ora_asm_vol.`

|                     |                                                                                                                                                                 |
|---------------------|-----------------------------------------------------------------------------------------------------------------------------------------------------------------|
| Redundancy          | Select the option <b>External</b> . Mirroring is performed by CVM.                                                                                              |
| Select member disks | Select the VxVM disks you want to use; You may need to select the <b>Force</b> checkbox next to the ASM disks you want to use if the disk group creation fails. |

For detailed instructions, see the Oracle documentation.

## Verifying the ASM setup

Verify that the database services for ASM are up and running after the installation.

### To verify the ASM installation

- 1 Change to the Oracle Clusterware/Grid Infrastructure home directory:

For Oracle RAC 10g Release 2/Oracle RAC 11g Release 1:

```
cd $CRS_HOME/bin
```

For Oracle RAC 11g Release 2:

```
cd $GRID_HOME/bin
```

- 2 Verify the status of ASM on all the nodes in the cluster:

```
./srvctl status asm
```

```
ASM instance +ASM1 is running on node sys1
```

The sample output shows that there is one ASM instance running on the local node.

## Configuring VCS service groups for database instances on ASM

This section describes how to configure the Oracle service group using the CLI for databases on ASM.

For sample service group illustration:

See “[sfrac05\\_main.cf file](#)” on page 563.

For a sample configuration file describing the configuration, see the file `sfrac05_main.cf` in the directory `/etc/VRTSvcs/conf/sample_rac/`.

The following procedure assumes that you have created the database.

**To configure the Oracle service group using the CLI**

- 1 Change the cluster configuration to read-write mode:

```
haconf -makerw
```

- 2 Add the service group to the VCS configuration:

```
hagrps -add dbgrp
```

- 3 Modify the attributes of the service group:

```
hagrps -modify dbgrp Parallel 1
```

```
hagrps -modify dbgrp SystemList sys1 0 sys2 1
```

```
hagrps -modify dbgrp AutoStartList sys1 sys2
```

- 4 Add the CVMVolDg resource for the service group:

```
hares -add oradata_voldg CVMVolDg dbgrp
```

- 5 Modify the attributes of the CVMVolDg resource for the service group:

```
hares -modify oradata_voldg CVMdiskGroup ora_asm_dg
```

```
hares -modify oradata_voldg CVMActivation sw
```

```
hares -modify oradata_voldg CVMVolume ora_asm_vol
```

- 6 Add the ASMDG resource for the service group:

```
hares -add asmdg ASMDG dbgrp
```

- 7 Modify the attributes of the ASMDG resource for the service group.

---

**Note:** The `$ASM_HOME` variable refers to the ASM home directory.

For Oracle RAC 10g Release 2/Oracle RAC 11g Release 1, the ASM home directory is distinct from the `ORACLE_HOME` directory.

---

For Oracle RAC 10g Release 2/Oracle RAC 11g Release 1:

```
hares -modify asmdg DiskGroups ASM_RAC_DG
hares -modify asmdg Home "$ASM_HOME"
hares -local asmdg Sid
hares -modify asmdg Sid "+ASM1" -sys sys1
hares -modify asmdg Sid "+ASM2" -sys sys2
hares -modify asmdg Owner oracle
```

For Oracle RAC 11g Release 2:

```
hares -modify asmdg DiskGroups ASM_RAC_DG
hares -modify asmdg Home "$ASM_HOME"
hares -local asmdg Sid
hares -modify asmdg Sid "+ASM1" -sys sys1
hares -modify asmdg Sid "+ASM2" -sys sys2
hares -modify asmdg Owner grid
```

- 8 Add the Oracle RAC database instance to the service group:

```
hares -add asmdb Oracle dbgrp
```

- 9 Modify the attributes of the Oracle resource for the service group:

```
hares -modify asmdb Owner oracle
hares -local asmdb Sid
hares -modify asmdb Sid oradb1 -sys sys1
hares -modify asmdb Sid oradb2 -sys sys2
hares -modify asmdb Home "$ORACLE_HOME"
hares -modify asmdb StartUpOpt SRVCTLSTART
hares -modify asmdb ShutDownOpt SRVCTLSTOP
```

- 10 Set the dependencies between the ASMDG resource and the CVMVolDg resource for the Oracle service group:

```
hares -link asmdg oradata_voldg
```

- 11 Set the dependencies between the Oracle resource and the ASMDG resource for the Oracle service group:

```
hares -link asmdb asmdg
```

- 12 Create an online local firm dependency between the dbgrp service group and the cvm service group:

```
hagrps -link dbgrp cvm online local firm
```

- 13 Enable the Oracle service group:

```
hagrps -enableresources dbgrp
```

- 14 Change the cluster configuration to the read-only mode:

```
haconf -dump -makero
```

- 15 Bring the Oracle service group online on all the nodes:

```
hagrps -online dbgrp -any
```

## Sample configuration file Veritas CVM and ASM main.cf file

A sample configuration file (`sfrac05_main.cf`) illustrating ASM configuration in SF Oracle RAC is available at `/etc/VRTSvcs/conf/sample_rac/`.

For an illustration of the service group configuration:

See [“sfrac05\\_main.cf file”](#) on page 563.

# Creating a test database

This appendix includes the following topics:

- [About creating a test database](#)
- [Creating a database for Oracle](#)

## About creating a test database

A test database can be created and used for both testing and troubleshooting purposes.

The following optional procedures describe the methods for creating a test database on shared storage.

Use your own tools or refer to the guidelines below on using the Oracle DBCA (Database Creation Assistant) tool to create a database on shared raw VxVM volumes or shared VxFS file systems.

## Creating a database for Oracle

Before you begin to create the database, ensure that the following prerequisites are met:

- The Clusterware/Grid daemons must be running.  
To verify the status of Oracle Clusterware, type the following command:  
For Oracle RAC 10g Release 2/Oracle RAC 11g Release 1:

```
$CRS_HOME/bin/crs_stat
```

For Oracle RAC 11g Release 2:

```
$GRID_HOME/bin/crsctl stat res -t
```

- All private IP addresses on each node must be up.  
Use the `ping` command to verify that all private IP addresses on each node are up.

Refer to your Oracle documentation for instructions on how to install the Oracle database.

You can create the database on one of the following types of storage:

- Shared raw volume  
See [“Creating the database storage on raw volumes”](#) on page 599.
- Cluster File System (CFS)  
See [“Creating the database storage on CFS”](#) on page 600.
- ASM  
See [“Creating database storage on ASM”](#) on page 592.

## Creating the database storage on raw volumes

You can create the database storage on shared raw volume.

**To create the database storage on shared raw volumes**

- 1 Log in as root user.
- 2 On the master node, create a shared disk group:

```
vxdg -s init oradatadg Disk_1
```

- 3 Create a volume in the shared group for each of the required tablespaces.

Refer to the Oracle documentation to determine the tablespace requirements.

For example, type:

```
vxassist -g oradatadg make VRT_sys1 1000M
vxassist -g oradatadg make VRT_spfile1 10M
.
.
```

- 4 Define the access mode and permissions for the volumes storing the Oracle data.

For each volume listed in \$ORACLE\_HOME/raw\_config, use the `vxedit(1M)` command:

```
vxedit -g disk_group set group=group user=user mode=660 volume
```

For example:

```
vxedit -g oradatadg set group=dba user=oracle mode=660 \
VRT_sys1
```

In this example, `VRT_sys1` is the name of one of the volumes. Repeat the command to define access mode and permissions for each volume in the `oradatadg`.

- 5 Create the database using the Oracle documentation.

## Creating the database storage on CFS

If you plan to use a cluster file system to store the Oracle database, use the following procedure to create the file system.

### To create the database storage on CFS

- 1 Create a disk group (for example, `oradatadg`):

```
vxdg -s init oradatadg Disk_1
```

- 2 Create a single shared volume (for example, `oradatavol`) that is large enough to contain a file system for all tablespaces.

For example, assuming 6.8 GB is required for database storage, type:

```
vxassist -g oradatadg make oradatavol 6800M
```

- 3 Set the activation mode (`sw`) to allow shared access to the disk group:

```
vxdg -g oradatadg set activation=sw
```

- 4 Start the volume in the disk group:

```
vxvol -g oradatadg startall
```

- 5 Create a VxFS file system in this volume. From one node, type:

```
mkfs -F vxfs -o largefiles /dev/vx/rdisk/oradatadg/oradatavol
```



- 6 Create a mount point for the shared file system:

```
mkdir /oradata
```

- 7 From the same node, mount the file system:

```
mount -F vxfs -o cluster /dev/vx/dsk/oradatadg/oradatavol1 \
/oradata
```

- 8 Set the "Oracle" user as the owner of the file system, and set "755" as the permissions:

```
chown oracle:oinstall /oradata
chmod 755 /oradata
```

- 9 On the other node(s), complete step 6 and step 7.
- 10 Create the database using the Oracle documentation.

# High availability agent information

This appendix includes the following topics:

- [About agents](#)
- [CVMCluster agent](#)
- [CVMVxconfigd agent](#)
- [CVMVolDg agent](#)
- [CFSMount agent](#)
- [CFSfsckd agent](#)
- [PrivNIC agent](#)
- [MultiPrivNIC agent](#)
- [CSSD agent](#)
- [VCS agents for Oracle](#)
- [CRSResource agent](#)

## About agents

An agent is defined as a process that starts, stops, and monitors all configured resources of a type, and reports their status to Veritas Cluster Server (VCS). Agents have both entry points and attributes. Entry points are also known as agent functions and are referred to as "agent functions" throughout the document.

Attributes contain data about the agent. An attribute has a definition and a value. You change attribute values to configure resources, which are defined as the individual components that work together to provide application services to the public network. For example, a resource may be a physical component such as a disk or a network interface card, a software component such as Oracle or a Web server, or a configuration component such as an IP address or mounted file system.

Attributes are either optional or required, although sometimes the attributes that are optional in one configuration may be required in other configurations. Many optional attributes have predefined or default values, which you should change as required. A variety of internal use only attributes also exist. Do not modify these attributes—modifying them can lead to significant problems for your clusters. Attributes have type and dimension. Some attribute values can accept numbers, others can accept alphanumeric values or groups of alphanumeric values, while others are simple boolean on/off values.

The entry points and attributes for each SF Oracle RAC agent are described in this appendix.

## VCS agents included within SF Oracle RAC

SF Oracle RAC includes the following VCS agents:

- CVMCluster agent
- CVMVxconfigd agent
- CVMVolDg agent
- CFSSMount agent

An SF Oracle RAC installation automatically configures the CVMCluster resource and the CVMVxconfigd resource.

You must configure the CVMVolDg agent for each shared disk group. If the database uses cluster file systems, configure the CFSSMount agent for each volume in the disk group.

Use the information in this appendix about the entry points and attributes of the listed agents to make necessary configuration changes. For information on how to modify the VCS configuration:

See the *Veritas Cluster Server Administrator's Guide*

## VCS agents for Oracle included within SF Oracle RAC

SF Oracle RAC includes the following VCS agents for Oracle:

- Oracle agent

The Oracle agent monitors the database processes.

- **Netlsnr agent**  
The Netlsnr agent brings the listener services online, monitors their status, and takes them offline.
- **PrivNIC agent**  
The PrivNIC agent provides high availability to a single private IP address across LLT Ethernet interfaces for a system.
- **MultiPrivNIC agent**  
The MultiPrivNIC agent provides high availability to multiple private IP addresses across LLT Ethernet interfaces for a system.
- **CSSD agent**  
The CSSD (Cluster Synchronization Services daemon) agent provides the resources to monitor Oracle Clusterware. The agent ensures that the dependency of cssd on the OCR and the VOTE resources and the PrivNIC (optional) resource are satisfied.
- **ASMDG agent**  
The ASMDG agent mounts and unmounts the ASM disk groups onto an ASM instance.

See the *Veritas Cluster Server Agent for Oracle Installation and Configuration Guide*

## CVMCluster agent

The CVMCluster agent controls system membership on the cluster port that is associated with Veritas Volume Manager (VxVM).

The CVMCluster agent performs the following functions:

- Joins a node to the CVM cluster port.
- Removes a node from the CVM cluster port.
- Monitors the node's cluster membership state.

## Entry points for CVMCluster agent

[Table H-1](#) describes the entry points used by the CVMCluster agent.

**Table H-1** CVMCluster agent entry points

| Entry Point | Description                                                                                                                               |
|-------------|-------------------------------------------------------------------------------------------------------------------------------------------|
| Online      | Joins a node to the CVM cluster port. Enables the Volume Manager cluster functionality by automatically importing the shared disk groups. |

**Table H-1** CVMCluster agent entry points (*continued*)

| Entry Point | Description                                       |
|-------------|---------------------------------------------------|
| Offline     | Removes a node from the CVM cluster port.         |
| Monitor     | Monitors the node's CVM cluster membership state. |

## Attribute definition for CVMCluster agent

[Table H-2](#) describes the user-modifiable attributes of the CVMCluster resource type.

**Table H-2** CVMCluster agent attributes

| Attribute    | Description                                                                                                                                                                                            |
|--------------|--------------------------------------------------------------------------------------------------------------------------------------------------------------------------------------------------------|
| CVMClustName | Name of the cluster. <ul style="list-style-type: none"> <li>Type and dimension: string-scalar</li> </ul>                                                                                               |
| CVMNodeAddr  | List of host names and IP addresses. <ul style="list-style-type: none"> <li>Type and dimension: string-association</li> </ul>                                                                          |
| CVMNodeId    | Associative list. The first part names the system; the second part contains the LLT ID number for the system. <ul style="list-style-type: none"> <li>Type and dimension: string-association</li> </ul> |
| CVMTransport | Specifies the cluster messaging mechanism. <ul style="list-style-type: none"> <li>Type and dimension: string-scalar</li> <li>Default = gab</li> </ul> <p><b>Note:</b> Do not change this value.</p>    |
| PortConfigd  | The port number that is used by CVM for vxconfigd-level communication. <ul style="list-style-type: none"> <li>Type and dimension: integer-scalar</li> </ul>                                            |
| PortKmsgd    | The port number that is used by CVM for kernel-level communication. <ul style="list-style-type: none"> <li>Type and dimension: integer-scalar</li> </ul>                                               |
| CVMTimeout   | Timeout in seconds used for CVM cluster reconfiguration. <ul style="list-style-type: none"> <li>Type and dimension: integer-scalar</li> <li>Default = 200</li> </ul>                                   |

## CVMCluster agent type definition

The following type definition is included in the file, `CVMTypes.cf`:

```
type CVMCluster (
 static keylist RegList = { CVMNodePreference }
 static int NumThreads = 1
 static int OnlineRetryLimit = 2
 static int OnlineTimeout = 400
 static str ArgList[] = { CVMTransport, CVMClustName,
 CVMNodeAddr, CVMNodeId, PortConfigd,
 PortKmsgd, CVMTimeout }

 str CVMClustName
 str CVMNodeAddr{}
 str CVMNodeId{}
 str CVMTransport
 str CVMNodePreference
 int PortConfigd
 int PortKmsgd
 int CVMTimeout
)
```

---

**Note:** The attributes `CVMNodeAddr`, `PortConfigd`, and `PortKmsgd` are not used in an SF Oracle RAC environment. GAB, the required cluster communication messaging mechanism, does not use them.

---

## CVMCluster agent sample configuration

The following is an example definition for the CVMCluster service group:

```
CVMCluster cvm_clus (
 Critical = 0
 CVMClustName = clus1
 CVMNodeId = { sys1 = 0, sys2 = 1 }
 CVMTransport = gab
 CVMTimeout = 200
)
```

## CVMVxconfigd agent

The CVMVxconfigd agent starts and monitors the vxconfigd daemon. The vxconfigd daemon maintains disk and disk group configurations, communicates configuration

changes to the kernel, and modifies the configuration information that is stored on disks. CVMVxconfigd must be present in the CVM service group.

The CVMVxconfigd agent is an OnOnly agent; the agent starts the resource when the cluster starts up and VCS restarts the resource when necessary. The Operations attribute specifies these default aspects of startup.

Symantec recommends starting the vxconfigd daemon with the `syslog` option, which enables logging of debug messages. Note that the SF Oracle RAC installation configures the `syslog` option for the CVMVxconfigd agent.

This agent is IMF-aware and uses asynchronous monitoring framework (AMF) kernel driver for IMF notification. For more information about the Intelligent Monitoring Framework (IMF) and intelligent resource monitoring, refer to the *Veritas Cluster Server Administrator's Guide*.

## Entry points for CVMVxconfigd agent

[Table H-3](#) describes the entry points for the CVMVxconfigd agent.

**Table H-3** CVMVxconfigd entry points

| Entry Point                      | Description                                                                                                                                                                                                                                                                                                         |
|----------------------------------|---------------------------------------------------------------------------------------------------------------------------------------------------------------------------------------------------------------------------------------------------------------------------------------------------------------------|
| Online                           | Starts the <code>vxconfigd</code> daemon                                                                                                                                                                                                                                                                            |
| Offline                          | N/A                                                                                                                                                                                                                                                                                                                 |
| Monitor                          | Monitors whether <code>vxconfigd</code> daemon is running                                                                                                                                                                                                                                                           |
| <code>imf_init</code>            | Initializes the agent to interface with the AMF kernel module. This function runs when the agent starts up.                                                                                                                                                                                                         |
| <code>imf_getnotification</code> | Gets notification about the <code>vxconfigd</code> process state. This function runs after the agent initializes with the AMF kernel module. This function continuously waits for notification. If the <code>vxconfigd</code> process fails, the function initiates a traditional CVMVxconfigd monitor entry point. |
| <code>imf_register</code>        | Registers or unregisters the <code>vxconfigd</code> process id (pid) with the AMF kernel module. This function runs after the resource goes into steady online state.                                                                                                                                               |

## Attribute definition for CVMVxconfigd agent

[Table H-4](#) describes the modifiable attributes of the CVMVxconfigd resource type.

**Table H-4** CVMVxconfigd agent attribute

| Attribute        | Description                                                                                                                                                                                                                                                                                                                                                                                                                                                                                                                                                                                                                                                                                                                                                                                                                                                                                                                                                                                                                                                                                                                                                                                                                                                                                                                                                                                                                                                                                                                                                                                                                                                                                                                                                                                                                                                                                                                                                                                                                                                                                                                                                                                          |
|------------------|------------------------------------------------------------------------------------------------------------------------------------------------------------------------------------------------------------------------------------------------------------------------------------------------------------------------------------------------------------------------------------------------------------------------------------------------------------------------------------------------------------------------------------------------------------------------------------------------------------------------------------------------------------------------------------------------------------------------------------------------------------------------------------------------------------------------------------------------------------------------------------------------------------------------------------------------------------------------------------------------------------------------------------------------------------------------------------------------------------------------------------------------------------------------------------------------------------------------------------------------------------------------------------------------------------------------------------------------------------------------------------------------------------------------------------------------------------------------------------------------------------------------------------------------------------------------------------------------------------------------------------------------------------------------------------------------------------------------------------------------------------------------------------------------------------------------------------------------------------------------------------------------------------------------------------------------------------------------------------------------------------------------------------------------------------------------------------------------------------------------------------------------------------------------------------------------------|
| CVMVxconfigdArgs | <p>List of the arguments that are sent to the <code>online</code> entry point.</p> <p>Symantec recommends always specifying the <code>syslog</code> option.</p> <ul style="list-style-type: none"> <li>■ Type and dimension: keylist</li> </ul>                                                                                                                                                                                                                                                                                                                                                                                                                                                                                                                                                                                                                                                                                                                                                                                                                                                                                                                                                                                                                                                                                                                                                                                                                                                                                                                                                                                                                                                                                                                                                                                                                                                                                                                                                                                                                                                                                                                                                      |
| IMF              | <p>This resource-type level attribute determines whether the CVMVxconfigd agent must perform intelligent resource monitoring. You can also override the value of this attribute at resource-level.</p> <p>This attribute includes the following keys:</p> <ul style="list-style-type: none"> <li>■ Mode: Define this attribute to enable or disable intelligent resource monitoring.<br/> Valid values are as follows: <ul style="list-style-type: none"> <li>■ 0—Does not perform intelligent resource monitoring</li> <li>■ 2—Performs intelligent resource monitoring for online resources and performs poll-based monitoring for offline resources</li> </ul> Default: 0 </li> <li>■ MonitorFreq: This key value specifies the frequency at which the agent invokes the monitor agent function. The value of this key is an integer.<br/> Default: 1<br/> You can set this key to a non-zero value for cases where the agent requires to perform both poll-based and intelligent resource monitoring. If the value is 0, the agent does not perform poll-based process check monitoring.<br/> After the resource registers with the AMF kernel driver, the agent calls the monitor agent function as follows: <ul style="list-style-type: none"> <li>■ After every (MonitorFreq x MonitorInterval) number of seconds for online resources</li> <li>■ After every (MonitorFreq x OfflineMonitorInterval) number of seconds for offline resources</li> </ul> </li> <li>■ RegisterRetryLimit: If you enable intelligent resource monitoring, the agent invokes the <code>imf_register</code> agent function to register the resource with the AMF kernel driver. The value of the RegisterRetyLimit key determines the number of times the agent must retry registration for a resource. If the agent cannot register the resource within the limit that is specified, then intelligent monitoring is disabled until the resource state changes or the value of the Mode key changes.<br/> Default: 3.</li> <li>■ Type and dimension: integer-association</li> </ul> <p>For more details of IMF attribute for the agent type, refer to the <i>Veritas Cluster Server Administrator's Guide</i>.</p> |



## CVMVxconfigd agent type definition

The following type definition is included in the CVMTypes.cf file:

```
type CVMVxconfigd (
 static int IMF{} = { Mode=2, MonitorFreq=1, RegisterRetryLimit=3 }
 static int FaultOnMonitorTimeouts = 2
 static int RestartLimit = 5
 static str ArgList[] = { CVMVxconfigdArgs }
 static str Operations = OnOnly
 keylist CVMVxconfigdArgs
)
```

## CVMVxconfigd agent sample configuration

The following is an example definition for the `CVMVxconfigd` resource in the CVM service group:

```
CVMVxconfigd cvm_vxconfigd (
 Critical = 0
 CVMVxconfigdArgs = { syslog }
)
```

## CVMVoIDg agent

The CVMVoIDg agent manages the CVM disk groups and CVM volumes and volume sets within the disk groups by performing the following functions:

- Imports the shared disk group from the CVM master node
- Starts the volumes and volume sets in the disk group
- Monitors the disk group, volumes, and volume sets
- Optionally, deports the disk group when the dependent applications are taken offline. The agent deports the disk group only if the appropriate attribute is set.

Configure the CVMVoIDg agent for each disk group used by a Oracle service group. A disk group must be configured to only one Oracle service group. If cluster file systems are used for the database, configure the CFSMount agent for each volume or volume set in the disk group.

## Entry points for CVMVoIDg agent

[Table H-5](#) describes the entry points used by the CVMVoIDg agent.

**Table H-5** CVMVoIDg agent entry points

| Entry Point | Description                                                                                                                                                                                                                                                                                                                                                                                                                                                                                                                                                                                                |
|-------------|------------------------------------------------------------------------------------------------------------------------------------------------------------------------------------------------------------------------------------------------------------------------------------------------------------------------------------------------------------------------------------------------------------------------------------------------------------------------------------------------------------------------------------------------------------------------------------------------------------|
| Online      | <p>Imports the shared disk group from the CVM master node, if the disk group is not already imported.</p> <p>Starts all volumes and volume sets in the shared disk group specified by the CVMVolume attribute.</p> <p>Sets the disk group activation mode to shared-write if the value of the CVMActivation attribute is sw. You can set the activation mode on both slave and master systems.</p>                                                                                                                                                                                                         |
| Offline     | <p>Removes the temporary files created by the online entry point.</p> <p>If the <code>CVMDeportOnOffline</code> attribute is set to 1 and if the shared disk group does not contain open volumes on any node in the cluster, the disk group is deported from the CVM master node.</p>                                                                                                                                                                                                                                                                                                                      |
| Monitor     | <p>Determines whether the disk group, the volumes, and the volume sets are online.</p> <p>The agent takes a volume set offline if the file system metadata volume of a volume set is discovered to be offline in a monitor cycle.</p> <p><b>Note:</b> If the CFSMount resource goes offline and the file system on the volume set is unmounted, the agent retains the online state of the volume set even if the file system metadata volume in the volume set is offline. This is because the CVMVoIDg agent is unable to determine whether or not the volumes that are offline are metadata volumes.</p> |
| Clean       | Removes the temporary files created by the online entry point.                                                                                                                                                                                                                                                                                                                                                                                                                                                                                                                                             |

## Attribute definition for CVMVoIDg agent

[Table H-6](#) describes the user-modifiable attributes of the CVMVoIDg resource type.

**Table H-6** CVMVoIDg agent attributes

| Attribute               | Description                                                                                                        |
|-------------------------|--------------------------------------------------------------------------------------------------------------------|
| CVMDiskGroup (required) | <p>Shared disk group name.</p> <ul style="list-style-type: none"> <li>Type and dimension: string-scalar</li> </ul> |

Table H-6 CVMVoIDg agent attributes (continued)

| Attribute                     | Description                                                                                                                                                                                                                                                                                                                                                                                                                                                                                                                                                                                                                                                                                                                                                                                                                                                                                                                                                                                                                                                                                                                                                                                                                                                                                                                     |
|-------------------------------|---------------------------------------------------------------------------------------------------------------------------------------------------------------------------------------------------------------------------------------------------------------------------------------------------------------------------------------------------------------------------------------------------------------------------------------------------------------------------------------------------------------------------------------------------------------------------------------------------------------------------------------------------------------------------------------------------------------------------------------------------------------------------------------------------------------------------------------------------------------------------------------------------------------------------------------------------------------------------------------------------------------------------------------------------------------------------------------------------------------------------------------------------------------------------------------------------------------------------------------------------------------------------------------------------------------------------------|
| CVMVolume (required)          | <p>Name of shared volumes or volume sets. This list is used to check that the volumes or volume sets are in the correct state before allowing the resource to come online, and that the volumes remain in an enabled state.</p> <ul style="list-style-type: none"> <li>Type and dimension: string-keylist</li> </ul>                                                                                                                                                                                                                                                                                                                                                                                                                                                                                                                                                                                                                                                                                                                                                                                                                                                                                                                                                                                                            |
| CVMActivation (required)      | <p>Activation mode for the disk group.</p> <ul style="list-style-type: none"> <li>Type and dimension: string-scalar</li> <li>Default = <code>sw</code> (<code>shared-write</code>)</li> </ul> <p>This is a localized attribute.</p>                                                                                                                                                                                                                                                                                                                                                                                                                                                                                                                                                                                                                                                                                                                                                                                                                                                                                                                                                                                                                                                                                             |
| CVMVolumeIoTest(optional)     | <p>List of volumes and volume sets that will be periodically polled to test availability. The polling is in the form of 4 KB reads every monitor cycle to a maximum of 10 of the volumes or volume sets in the list. For volume sets, reads are done on a maximum of 10 component volumes in each volume set.</p> <ul style="list-style-type: none"> <li>Type and dimension: string-keylist</li> </ul>                                                                                                                                                                                                                                                                                                                                                                                                                                                                                                                                                                                                                                                                                                                                                                                                                                                                                                                          |
| CVMDeportOnOffline (optional) | <p>Indicates whether or not the shared disk group must be deported when the last online CVMVoIDg resource for a disk group is taken offline.</p> <p>The value 1 indicates that the agent will deport the shared disk group from the CVM master node, if not already deported, when the last online CVMVoIDg resource for the disk group is taken offline.</p> <p>The value 0 indicates that the agent will not deport the shared disk group when the CVMVoIDg resource is taken offline.</p> <ul style="list-style-type: none"> <li>Type and dimension: integer-scalar</li> <li>Default = 0</li> </ul> <p><b>Note:</b> If multiple CVMVoIDg resources are configured for a shared disk group, set the value of the attribute to either 1 or 0 for all of the resources.</p> <p>The CVM disk group is deported based on the order in which the CVMVoIDg resources are taken offline. If the CVMVoIDg resources in the disk group contain a mixed setting of 1 and 0 for the <code>CVMDeportOnOffline</code> attribute, the disk group is deported only if the attribute value is 1 for the last CVMVoIDg resource taken offline. If the attribute value is 0 for the last CVMVoIDg resource taken offline, the disk group is not deported.</p> <p>The deport operation fails if the shared disk group contains open volumes.</p> |

## CVMVoIDg agent type definition

The `CVMTypes.cf` file includes the CVMVoIDg type definition:

```

type CVMVolDg (
 static keylist RegList = { CVMActivation, CVMVolume }
 static int OnlineRetryLimit = 2
 static int OnlineTimeout = 400
 static keylist ExternalStateChange = { OnlineGroup }
 static str ArgList[] = { CVMDiskGroup, CVMVolume, CVMActivation,
 CVMVolumeIoTest, CVMDGAction, CVMDeportOnOff
 CVMDeactivateOnOffline, State }

 str CVMDiskGroup
 str CVMDGAction
 keylist CVMVolume
 str CVMActivation
 keylist CVMVolumeIoTest
 int CVMDeportOnOffline
 int CVMDeactivateOnOffline
 temp int voldg_stat
)

```

## CVMVolDg agent sample configuration

Each Oracle service group requires a CVMVolDg resource type to be defined. The following is a sample configuration:

```

CVMVolDg ora_voldg (
 Critical = 0
 CVMDiskGroup = oradatadg
 CVMVolume = { oradata1, oradata2 }
 CVMActivation = sw
)

```

## CFSMount agent

The CFSMount agent brings online, takes offline, and monitors a cluster file system mount point.

The agent executable is located in `/opt/VRTSvcs/bin/CFSMount/CFSMountAgent`.

The CFSMount type definition is described in the `/etc/VRTSvcs/conf/config/CFSTypes.cf` file.

This agent is IMF-aware and uses asynchronous monitoring framework (AMF) kernel driver for IMF notification. For more information about the Intelligent Monitoring Framework (IMF) and intelligent resource monitoring, refer to the *Veritas Cluster Server Administrator's Guide*.

## Entry points for CFSMount agent

Table H-7 provides the entry points for the CFSMount agent.

**Table H-7** CFSMount agent entry points

| Entry Point         | Description                                                                                                                                                                                                                      |
|---------------------|----------------------------------------------------------------------------------------------------------------------------------------------------------------------------------------------------------------------------------|
| Online              | Mounts a block device in cluster mode.                                                                                                                                                                                           |
| Offline             | Unmounts the file system, forcing unmount if necessary, and sets primary to secondary if necessary.                                                                                                                              |
| Monitor             | Determines if the file system is mounted. Checks mount status using the <code>fsclustadm</code> command.                                                                                                                         |
| Clean               | Generates a null operation for a cluster file system mount.                                                                                                                                                                      |
| imf_init            | Initializes the agent to interface with the AMF kernel driver, which is the IMF notification module for the agent. This function runs when the agent starts up.                                                                  |
| imf_getnotification | Gets notification about resource state changes. This function runs after the agent initializes with the AMF kernel module. This function continuously waits for notification and takes action on the resource upon notification. |
| imf_register        | Registers or unregisters resource entities with the AMF kernel module. This function runs for each resource after the resource goes into steady state (online or offline).                                                       |

## Attribute definition for CFSMount agent

Table H-8 lists user-modifiable attributes of the CFSMount Agent resource type.

**Table H-8** CFSMount Agent attributes

| Attribute   | Description                                                                                                           |
|-------------|-----------------------------------------------------------------------------------------------------------------------|
| MountPoint  | Directory for the mount point. <ul style="list-style-type: none"> <li>Type and dimension: string-scalar</li> </ul>    |
| BlockDevice | Block device for the mount point. <ul style="list-style-type: none"> <li>Type and dimension: string-scalar</li> </ul> |

**Table H-8** CFSMount Agent attributes (*continued*)

| Attribute | Description                                                                                                                                                                                                                                                                                                                                                                                                                                                                                                                                                                                                                                                                                                                                                                                                                                                                                                                                                                                                                                                                                                                                                                                                                                                                                                                                                                                                                                                                                                                                                                                                                                                                                                                                                                                                                                                                                                                                                                                                                                                                                                                                                                                                                                                                             |
|-----------|-----------------------------------------------------------------------------------------------------------------------------------------------------------------------------------------------------------------------------------------------------------------------------------------------------------------------------------------------------------------------------------------------------------------------------------------------------------------------------------------------------------------------------------------------------------------------------------------------------------------------------------------------------------------------------------------------------------------------------------------------------------------------------------------------------------------------------------------------------------------------------------------------------------------------------------------------------------------------------------------------------------------------------------------------------------------------------------------------------------------------------------------------------------------------------------------------------------------------------------------------------------------------------------------------------------------------------------------------------------------------------------------------------------------------------------------------------------------------------------------------------------------------------------------------------------------------------------------------------------------------------------------------------------------------------------------------------------------------------------------------------------------------------------------------------------------------------------------------------------------------------------------------------------------------------------------------------------------------------------------------------------------------------------------------------------------------------------------------------------------------------------------------------------------------------------------------------------------------------------------------------------------------------------------|
| NodeList  | <p>List of nodes on which to mount. If NodeList is NULL, the agent uses the service group system list.</p> <ul style="list-style-type: none"> <li>■ Type and dimension: string-keylist</li> </ul>                                                                                                                                                                                                                                                                                                                                                                                                                                                                                                                                                                                                                                                                                                                                                                                                                                                                                                                                                                                                                                                                                                                                                                                                                                                                                                                                                                                                                                                                                                                                                                                                                                                                                                                                                                                                                                                                                                                                                                                                                                                                                       |
| IMF       | <p>Resource-type level attribute that determines whether the CFSMount agent must perform intelligent resource monitoring. You can also override the value of this attribute at resource-level.</p> <p>This attribute includes the following keys:</p> <ul style="list-style-type: none"> <li>■ Mode: Define this attribute to enable or disable intelligent resource monitoring.<br/> Valid values are as follows: <ul style="list-style-type: none"> <li>■ 0—Does not perform intelligent resource monitoring</li> <li>■ 1—Performs intelligent resource monitoring for offline resources and performs poll-based monitoring for online resources</li> <li>■ 2—Performs intelligent resource monitoring for online resources and performs poll-based monitoring for offline resources</li> <li>■ 3—Performs intelligent resource monitoring for both online and for offline resources</li> </ul> Default: 0</li> <li>■ MonitorFreq: This key value specifies the frequency at which the agent invokes the monitor agent function. The value of this key is an integer.<br/> Default: 1<br/> You can set this key to a non-zero value for cases where the agent requires to perform both poll-based and intelligent resource monitoring. If the value is 0, the agent does not perform poll-based process check monitoring.<br/> After the resource registers with the AMF kernel driver, the agent calls the monitor agent function as follows: <ul style="list-style-type: none"> <li>■ After every (MonitorFreq x MonitorInterval) number of seconds for online resources</li> <li>■ After every (MonitorFreq x OfflineMonitorInterval) number of seconds for offline resources</li> </ul> </li> <li>■ RegisterRetryLimit: If you enable intelligent resource monitoring, the agent invokes the imf_register agent function to register the resource with the AMF kernel driver. The value of the RegisterRetyLimit key determines the number of times the agent must retry registration for a resource. If the agent cannot register the resource within the limit that is specified, then intelligent monitoring is disabled until the resource state changes or the value of the Mode key changes.<br/> Default: 3.</li> <li>■ Type and dimension: integer-association</li> </ul> |

**Table H-8** CFSMount Agent attributes (*continued*)

| Attribute                    | Description                                                                                                                                                                                                                                                                                                                                                                                                                                                                                                                                                                              |
|------------------------------|------------------------------------------------------------------------------------------------------------------------------------------------------------------------------------------------------------------------------------------------------------------------------------------------------------------------------------------------------------------------------------------------------------------------------------------------------------------------------------------------------------------------------------------------------------------------------------------|
| MountOpt<br>(optional)       | <p>Options for the mount command. To create a valid MountOpt attribute string:</p> <ul style="list-style-type: none"> <li>Use the VxFS type-specific options only.</li> <li>Do not use the <code>-o</code> flag to specify the VxFS-specific options.</li> <li>Do not use the <code>-F vxfs</code> file system type option.</li> <li>Be aware the cluster option is not required.</li> <li>Specify options in comma-separated list: <pre>ro ro,cluster blkclear,mincache=closesync</pre> </li> </ul> <ul style="list-style-type: none"> <li>Type and dimension: string-scalar</li> </ul> |
| Policy (optional)            | <p>List of nodes to assume the primaryship of the cluster file system if the primary fails. If set to NULL or if none of the hosts specified in the list is active when the primary fails, a node is randomly selected from the set of active nodes to assume primaryship.</p> <ul style="list-style-type: none"> <li>Type and dimension: string-scalar</li> </ul>                                                                                                                                                                                                                       |
| Primary<br>(Not set by user) | <p>Information only. Stores the primary node name for a VxFS file system. The value is automatically modified in the configuration file when an unmounted file system is mounted or another node becomes the primary node. The user does not set this attribute and user programs do not rely on this attribute.</p> <ul style="list-style-type: none"> <li>Type and dimension: string-scalar</li> </ul>                                                                                                                                                                                 |

## CFSMount agent type definition

The `CFSTypes.cf` file includes the CFSMount agent type definition:

```
type CFSMount (
 static int IMF{} = { Mode=3, MonitorFreq=1, RegisterRetryLimit=3 }
 static keylist RegList = { MountOpt, Policy, NodeList, ForceOff, SetPrimary }
 static keylist SupportedActions = { primary }
 static int FaultOnMonitorTimeouts = 1
 static int OnlineWaitLimit = 1
 static str ArgList[] = { MountPoint, BlockDevice, MountOpt, Primary, AMFMountType }
 str MountPoint
 str MountType
 str BlockDevice
 str MountOpt
 keylist NodeList
```

```

keylist Policy
temp str Primary
str SetPrimary
temp str RemountRes
temp str AMFMountType
str ForceOff
)

```

## CFSMount agent sample configuration

Each Oracle service group requires a CFSMount resource type to be defined:

```

CFSMount ora_mount (
 MountPoint = "/oradata"
 BlockDevice = "/dev/vx/dsk/oradatadg/oradatavol1"
 Primary = sys2;
)

```

## CFSfsckd agent

The CFSfsckd agent starts, stops, and monitors the `vxfsckd` process. The CFSfsckd agent executable is `/opt/VRTSvcs/bin/CFSfsckd/CFSfsckdAgent`. The type definition is in the `/etc/VRTSvcs/conf/config/CFSTypes.cf` file. The configuration is added to the `main.cf` file after running the `cfsccluster config` command.

This agent is IMF-aware and uses asynchronous monitoring framework (AMF) kernel driver for IMF notification. For more information about the Intelligent Monitoring Framework (IMF) and intelligent resource monitoring, refer to the *Veritas Cluster Server Administrator's Guide*.

## Entry points for CFSfsckd agent

[Table H-9](#) describes the CFSfsckd agent entry points.

**Table H-9** CFSfsckd agent entry points

| Entry Points | Description                                                 |
|--------------|-------------------------------------------------------------|
| Online       | Starts the <code>vxfsckd</code> process.                    |
| Offline      | Kills the <code>vxfsckd</code> process.                     |
| Monitor      | Checks whether the <code>vxfsckd</code> process is running. |
| Clean        | A null operation for a cluster file system mount.           |



**Table H-9** CFSfsckd agent entry points (*continued*)

| Entry Points        | Description                                                                                                                                                                                                                      |
|---------------------|----------------------------------------------------------------------------------------------------------------------------------------------------------------------------------------------------------------------------------|
| imf_init            | Initializes the agent to interface with the AMF kernel driver, which is the IMF notification module for the agent. This function runs when the agent starts up.                                                                  |
| imf_getnotification | Gets notification about resource state changes. This function runs after the agent initializes with the AMF kernel module. This function continuously waits for notification and takes action on the resource upon notification. |
| imf_register        | Registers or unregisters resource entities with the AMF kernel module. This function runs for each resource after the resource goes into steady state (online or offline).                                                       |

## Attribute definition for CFSfsckd agent

[Table H-10](#) lists user-modifiable attributes of the CFSfsckd Agent resource type.

Table H-10 CFSfsckd Agent attributes

| Attribute | Description                                                                                                                                                                                                                                                                                                                                                                                                                                                                                                                                                                                                                                                                                                                                                                                                                                                                                                                                                                                                                                                                                                                                                                                                                                                                                                                                                                                                                                                                                                                                                                                                                                                                                                                                                                                                                                                                                                                                                                                                                                                                                                                                                                                                                                                                                                     |
|-----------|-----------------------------------------------------------------------------------------------------------------------------------------------------------------------------------------------------------------------------------------------------------------------------------------------------------------------------------------------------------------------------------------------------------------------------------------------------------------------------------------------------------------------------------------------------------------------------------------------------------------------------------------------------------------------------------------------------------------------------------------------------------------------------------------------------------------------------------------------------------------------------------------------------------------------------------------------------------------------------------------------------------------------------------------------------------------------------------------------------------------------------------------------------------------------------------------------------------------------------------------------------------------------------------------------------------------------------------------------------------------------------------------------------------------------------------------------------------------------------------------------------------------------------------------------------------------------------------------------------------------------------------------------------------------------------------------------------------------------------------------------------------------------------------------------------------------------------------------------------------------------------------------------------------------------------------------------------------------------------------------------------------------------------------------------------------------------------------------------------------------------------------------------------------------------------------------------------------------------------------------------------------------------------------------------------------------|
| IMF       | <p>Resource-type level attribute that determines whether the CFSfsckd agent must perform intelligent resource monitoring. You can also override the value of this attribute at resource-level.</p> <p>This attribute includes the following keys:</p> <ul style="list-style-type: none"> <li>■ <b>Mode:</b> Define this attribute to enable or disable intelligent resource monitoring.<br/>Valid values are as follows: <ul style="list-style-type: none"> <li>■ 0—Does not perform intelligent resource monitoring</li> <li>■ 1—Performs intelligent resource monitoring for offline resources and performs poll-based monitoring for online resources</li> <li>■ 2—Performs intelligent resource monitoring for online resources and performs poll-based monitoring for offline resources</li> <li>■ 3—Performs intelligent resource monitoring for both online and for offline resources</li> </ul> Default: 0 </li> <li>■ <b>MonitorFreq:</b> This key value specifies the frequency at which the agent invokes the monitor agent function. The value of this key is an integer.<br/>Default: 1<br/>You can set this key to a non-zero value for cases where the agent requires to perform both poll-based and intelligent resource monitoring. If the value is 0, the agent does not perform poll-based process check monitoring.<br/>After the resource registers with the AMF kernel driver, the agent calls the monitor agent function as follows: <ul style="list-style-type: none"> <li>■ After every (MonitorFreq x MonitorInterval) number of seconds for online resources</li> <li>■ After every (MonitorFreq x OfflineMonitorInterval) number of seconds for offline resources</li> </ul> </li> <li>■ <b>RegisterRetryLimit:</b> If you enable intelligent resource monitoring, the agent invokes the imf_register agent function to register the resource with the AMF kernel driver. The value of the RegisterRetyLimit key determines the number of times the agent must retry registration for a resource. If the agent cannot register the resource within the limit that is specified, then intelligent monitoring is disabled until the resource state changes or the value of the Mode key changes.<br/>Default: 3.</li> <li>■ <b>Type and dimension:</b> integer-association</li> </ul> |

## CFSfsckd agent type definition

The CFSfsckd type definition:

```
type CFSfsckd (
 static int IMF{} = { Mode=3, MonitorFreq=1, RegisterRetryLimit=3 }
 static int RestartLimit = 1
```

```

 str ActivationMode{}
)

```

## CFSfsckd agent sample configuration

This is a sample of CFSfsckd configuration:

```

CFSfsckd vxfscckd (
)

```

## PrivNIC agent

The PrivNIC agent provides high availability to a single private IP address across LLT Ethernet interfaces for a system. Private IP addresses are required by Oracle Clusterware and the Oracle database to provide communication between the cluster nodes.

---

**Note:** The PrivNIC agent operates over LLT links. To use the agent, the Oracle Clusterware interconnects and the Oracle RAC database communication links must be configured as LLT links.

---

The PrivNIC agent relies on LLT to monitor the LLT Ethernet interfaces. It queries LLT for the number of visible nodes on each of the LLT Ethernet interfaces.

If LLT is unable to communicate with the peer nodes, one of the following actions take place:

- If the link of a peer node is unavailable for the `peerinact` duration, LLT sets the link status to `down`.
- If the link of a peer node is not reachable within the `peertrouble` duration, LLT sets the link status to `trouble`. If the attribute `EnableUseTroubleState` is set to 1, the agent fails over the IP address after the link goes into troubled state.

---

**Note:** Set the value of the `EnableUseTroubleState` attribute to 1 to enable faster failover of failed links to available links.

---

The PrivNIC agent provides a reliable alternative when operating system limitations prevent you from using NIC bonding to provide increased bandwidth using multiple network interfaces. In the event of a NIC failure or link failure, the agent fails over the private IP address from the failed link to the connected or available LLT link. If the preferred link becomes available, the IP address is failed back to the preferred link.

---

**Note:** The PrivNIC agent is not supported with Oracle RAC 11.2.0.2 and later versions. For more information, see <http://www.symantec.com/business/support/index?page=content&id=TECH145261>

---

## Functions of the PrivNIC agent

[Table H-11](#) describes the PrivNIC agent's monitor entry point.

---

**Note:** Because the resource is persistent, only the monitor entry point is required.

---

**Table H-11** PrivNIC agent entry point

| Entry Point | Description                                                                                                                                                                                                                                                                                                                                                                                                                                                                                                                                                                                                                                                                                                                                   |
|-------------|-----------------------------------------------------------------------------------------------------------------------------------------------------------------------------------------------------------------------------------------------------------------------------------------------------------------------------------------------------------------------------------------------------------------------------------------------------------------------------------------------------------------------------------------------------------------------------------------------------------------------------------------------------------------------------------------------------------------------------------------------|
| Monitor     | <p>The PrivNIC agent queries LLT to create a list of nodes visible on every LLT network interface. The PrivNIC agent then applies various filters to this list to arrive at a most desired failover decision and calculates a "winner" device on which to configure the IP address. The "winner" device is compared to the currently active device where the IP address is currently configured. If the active and "winner" devices are different, the PrivNIC agent initiates a failover to the "winner" device.</p> <p><b>Note:</b> The value of the <code>MonitorInterval</code> attribute for the PrivNIC agent is now set to a default value of 10 seconds. This means that the agent runs the monitor entry point every 10 seconds.</p> |

## Attributes of the PrivNIC agent

[Table H-12](#) describes the user-modifiable attributes of the PrivNIC agent.

**Table H-12** Required attributes for PrivNIC agent

| Attribute | Dimension            | Description                                                                                                                                                                                                                                                                                                                                                                                                                                                                                                                                                                                                                                |
|-----------|----------------------|--------------------------------------------------------------------------------------------------------------------------------------------------------------------------------------------------------------------------------------------------------------------------------------------------------------------------------------------------------------------------------------------------------------------------------------------------------------------------------------------------------------------------------------------------------------------------------------------------------------------------------------------|
| Device    | string - association | <p>Specifies the network interface device as shown by the <code>ifconfig</code> command and the network ID associated with the interface. Network IDs of the interfaces connected to the same physical network must match. The interface with the lower network-id has the higher preference for failover. Interfaces specified in the PrivNIC configuration should be exactly the same in name and total number as those which have been used for LLT configuration.</p> <p>At least one interface device must be specified.</p> <p>Example:</p> <pre>Device@sys1 = {lan1=0, lan2=1, lan3=2} Device@sys2 = {lan1=0, lan2=1, lan3=2}</pre> |
| Address   | string-scalar        | <p>The numerical private IP address.</p> <p>Checks are performed to determine if this is a valid IP address.</p> <p>When configuring private IPv4 addresses for Oracle Clusterware, make sure that there are no leading zeroes in any of the octets that comprise the IP address, for example X.X.X.01 or X.X.0X.1 or X.0X.X.1 or 0X.X.X.1.</p> <p>Ensure that the IPv4 addresses have the format as "X.X.X.1".</p> <p>The following is an example of an IPv4 address:</p> <pre>Address = "192.168.12.1"</pre>                                                                                                                             |
| Netmask   | string - association | <p>The numerical netmask for the private IP address. For example:</p> <pre>Netmask = "255.255.255.0"</pre>                                                                                                                                                                                                                                                                                                                                                                                                                                                                                                                                 |
| MTU       | string - association | <p>The maximum packet size, in bytes, that can be transmitted over LLT links. This value overrides the default MTU size of the network interface.</p>                                                                                                                                                                                                                                                                                                                                                                                                                                                                                      |

**Table H-12** Required attributes for PrivNIC agent (*continued*)

| Attribute             | Dimension | Description                                                                                                                                                                                                                                                                                                                                                  |
|-----------------------|-----------|--------------------------------------------------------------------------------------------------------------------------------------------------------------------------------------------------------------------------------------------------------------------------------------------------------------------------------------------------------------|
| EnableUseTroubleState | Boolean   | <p>Value of 1 or 0.</p> <p>The value 1 indicates that the PrivNIC agent fails over the IP address of a failed link even when the link state is marked <code>trouble</code>. The default value is 1.</p> <p>The value 0 indicates that the PrivNIC agent fails over the IP address of a failed link only when the link state is marked <code>down</code>.</p> |

## Optional attributes of the PrivNIC agent

**Table H-13** Optional attributes for PrivNIC agent

| Attribute | Dimension            | Description                                                                                                                                                                                                                                                                                                                                                                                                                                                                                                                                                                                                                                                                                                                                                                                                                                                                                                  |
|-----------|----------------------|--------------------------------------------------------------------------------------------------------------------------------------------------------------------------------------------------------------------------------------------------------------------------------------------------------------------------------------------------------------------------------------------------------------------------------------------------------------------------------------------------------------------------------------------------------------------------------------------------------------------------------------------------------------------------------------------------------------------------------------------------------------------------------------------------------------------------------------------------------------------------------------------------------------|
| DeviceTag | string - association | <p>Associates an LLT device "tag" with device via the network-id. If an LLT device tag (as specified in the <code>/etc/llttab</code> file) differs from the name of the network interface as shown in "ifconfig," then <code>DeviceTag</code> must be specified for that interface.</p> <p>For example: <code>/etc/llttab</code> contains:</p> <pre>link lan0 /dev/lan:0 - ether - - link lan1 /dev/lan:1 - ether - - link-lowpri lan0 /dev/lan:0 - ether - -</pre> <p>In the above case, <code>DeviceTag</code> does not need to be specified. However, if <code>/etc/llttab</code> contains:</p> <pre>link link1 /dev/lan:1 - ether - - link link2 /dev/lan:2 - ether - - link-lowpri spare /dev/lan:0 - ether - -</pre> <p>And,</p> <pre>Device@sys1 = { lan1=0, lan2=1, lan0=2 }</pre> <p><code>DeviceTag</code> needs to be specified as:</p> <pre>DeviceTag@sys1 = { link1=0, link2=1, spare=2 }</pre> |

**Table H-13** Optional attributes for PrivNIC agent (*continued*)

| Attribute     | Dimension      | Description                                                                                                                                                                                                                                                                                                                                                                                                                       |
|---------------|----------------|-----------------------------------------------------------------------------------------------------------------------------------------------------------------------------------------------------------------------------------------------------------------------------------------------------------------------------------------------------------------------------------------------------------------------------------|
| GabPort       | string-scalar  | A single lower-case letter specifying the name of the GAB port to be used for filtering. "o" is the default. NULL disables GAB port filtering.<br><br>Example: <code>GabPort = "b"</code>                                                                                                                                                                                                                                         |
| UseVirtualIP  | integer-scalar | The default is 0, which specifies that the agent use the physical interface for configuring the private IP address when possible.<br><br>The value 1 specifies that the agent always use the virtual interface for configuring the private IP address.<br><br>The value 2 (which includes the functionality of the value 1) specifies the agent should complain if the private IP address already exists on a physical interface. |
| UseSystemList | integer-scalar | The value 1 specifies that the agent use the SystemList of the service group to filter the node list. Default = 0.                                                                                                                                                                                                                                                                                                                |
| ExcludeNode   | integer-vector | List of nodes to permanently exclude from calculation.                                                                                                                                                                                                                                                                                                                                                                            |

## States of the PrivNIC agent

[Table H-14](#) lists the states of the PrivNIC agent.

**Table H-14** States of the PrivNIC agent

| State   | Description                                                                                                                       |
|---------|-----------------------------------------------------------------------------------------------------------------------------------|
| Online  | Indicates that the private IP address is available.                                                                               |
| Unknown | Indicates the inability to determine the state of the resource due to incorrect attribute settings or other configuration issues. |

## Sample service group configuration with the PrivNIC agent

[Figure H-1](#) illustrates a basic service group configuration with the PrivNIC agent.

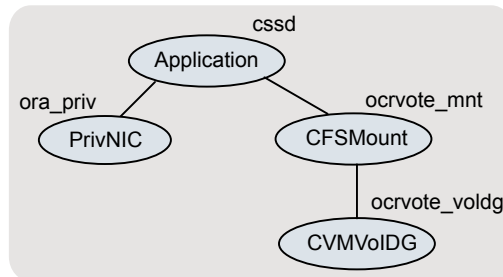
**Figure H-1** Basic service group configuration with the PrivNIC agent

This configuration shows the dependency of the CSSD resource on the private IP address configured as a PrivNIC resource along with the OCR and voting disk volume and mount point dependencies.

For sample deployment scenarios, see the appendix *SF Oracle RAC deployment scenarios*.

## Type definition of the PrivNIC resource

The following extract shows the type definition of the PrivNIC resource in the `PrivNIC.cf` file:

```

type PrivNIC (
 static str ArgList[] = { Device, DeviceTag, Address,
 NetMask, UseVirtualIP, GabPort, UseSystemList,
 ExcludeNode, MTU, EnableUseTroubleState }
 static int OfflineMonitorInterval = 60
 static int MonitorTimeout = 300
 static int MonitorInterval = 10
 static str Operations = None

 str Device{}
 str DeviceTag{}
 str Address = ""
 str NetMask = ""
 int UseVirtualIP = 0
 str GabPort = "o"
 int UseSystemList = 0
 int ExcludeNode[]
 str MTU{}
 int EnableUseTroubleState = 1
)

```



## Sample configuration of the PrivNIC resource

The following extract from the configuration file illustrates the configuration of a PrivNIC resource.

```
group cvm (
 SystemList = { sys1 = 0, sys2 = 1 }
 AutoFailOver = 0
 Parallel = 1
 AutoStartList = { sys1, sys2 }
)

PrivNIC ora_priv (
 Critical = 0
 Device@sys1 = { lan1 = 0, lan2 = 1 }
 Device@sys2 = { lan1 = 0, lan2 = 1 }
 Address@sys1 = "192.168.12.1"
 Address@sys2 = "192.168.12.2"
 NetMask = "255.255.255.0"
)
```

For more examples, see the sample configuration files located at `/etc/VRTSvcs/conf/sample_rac/`.

## MultiPrivNIC agent

The MultiPrivNIC agent provides high availability to multiple private IP addresses across LLT Ethernet interfaces for a system. In the event of a NIC failure or link failure, the agent fails over the private IP address from the failed link to one of the available LLT links. To use the agent, the Oracle Clusterware interconnects and the Oracle RAC database communication links must be configured as LLT links.

The MultiPrivNIC agent is a reliable alternative in scenarios where operating system limitations prevent you from using NIC bonding to provide increased bandwidth and high availability using multiple network interfaces. Even if link aggregation solutions in the form of bonded NICs are implemented, the MultiPrivNIC agent can be used to provide additional protection against the failure of aggregated links by failing over the IP addresses to the available alternate links. These alternate links can be simple NIC interfaces or bonded NICs.

---

**Note:** The MultiPrivNIC agent is not supported with Oracle RAC 11.2.0.2 and later versions. For more information, see <http://www.symantec.com/business/support/index?page=content&id=TECH145261>

---

## Managing high availability of private interconnects

The MultiPrivNIC agent operates over LLT links and relies on LLT to monitor the cluster interfaces. It queries LLT to count and report the number of visible nodes on each of the LLT interfaces.

If LLT is unable to communicate with the peer nodes, one of the following actions take place:

- If the link of a peer node is unavailable for the `peerinact` duration, LLT sets the link status to `down`.
- If the link of a peer node is not reachable within the `peertrouble` duration, LLT sets the link status to `trouble`. If the attribute `EnableUseTroubleState` is set to 1, the agent fails over the IP address after the link goes into troubled state.

---

**Note:** Set the value of the `EnableUseTroubleState` attribute to 1 to enable faster failover of failed links to available links.

---

When a preferred link goes into the `down` or `trouble` state, the IP address is failed over to the private link on which maximum number of peer nodes are visible. If multiple links see maximum nodes and if load-balancing is enabled, the agent considers the current traffic on all devices and calculates a "winner" device with lower traffic. If load balancing is not enabled, the IP address is failed over to the link with the lower network-id.

The failover decision for an IP address is made only when the link hosting the IP address fails. If the preferred link becomes available, the IP address is failed back to the preferred link regardless of whether load-balancing is enabled or disabled.

## Functions of the MultiPrivNIC agent

[Table H-15](#) describes the MultiPrivNIC agent's monitor entry point.

---

**Note:** Because the resource is persistent, only the monitor entry point is required.

---

**Table H-15** MultiPrivNIC agent entry point

| Entry point | Description                                                                                                                                                                                                                                                                                                                                                                                                                                                                                                                                                                                                                                                    |
|-------------|----------------------------------------------------------------------------------------------------------------------------------------------------------------------------------------------------------------------------------------------------------------------------------------------------------------------------------------------------------------------------------------------------------------------------------------------------------------------------------------------------------------------------------------------------------------------------------------------------------------------------------------------------------------|
| Monitor     | <p>The MultiPrivNIC agent queries LLT to create a list of the visible nodes on each LLT network interface.</p> <p>The agent applies various filters to this list and calculates a winner device on which to configure the IP address.</p> <p>If the active device on which the IP address is configured does not see the same number of nodes as the winner device, the agent fails over the IP address to the winner device.</p> <p><b>Note:</b> The value of the <code>MonitorInterval</code> attribute for the MultiPrivNIC agent is now set to a default value of 10 seconds. This means that the agent runs the monitor entry point every 10 seconds.</p> |

## Attributes of the MultiPrivNIC agent

[Table H-16](#) below describes the user-modifiable attributes of the MultiPrivNIC resource type.

**Table H-16** MultiPrivNIC agent attribute definitions

| Attribute | Dimension          | Description                                                                                                                                                                                                                                                                                                                                                                                                                                                                                                                                                                    |
|-----------|--------------------|--------------------------------------------------------------------------------------------------------------------------------------------------------------------------------------------------------------------------------------------------------------------------------------------------------------------------------------------------------------------------------------------------------------------------------------------------------------------------------------------------------------------------------------------------------------------------------|
| Device    | string-association | <p>The device attribute specifies the network interface displayed by the <code>ifconfig</code> command and the network ID associated with the interface.</p> <p>The network IDs of the interfaces connected to the same physical network must match. The interfaces specified in the MultiPrivNIC configuration should be exactly the same in name and total number as those which have been used for LLT configuration.</p> <p>An example of the device attribute is as follows:</p> <pre>Device@sys1 = {lan1=0, lan2=1, lan3=2} Device@sys2 = {lan1=0, lan2=1, lan3=2}</pre> |

**Table H-16** MultiPrivNIC agent attribute definitions (*continued*)

| Attribute | Dimension          | Description                                                                                                                                                                                                                                                                                                                                                                                                                                                                                                                                                                                                                                                                                                                                                                                                                                                                   |
|-----------|--------------------|-------------------------------------------------------------------------------------------------------------------------------------------------------------------------------------------------------------------------------------------------------------------------------------------------------------------------------------------------------------------------------------------------------------------------------------------------------------------------------------------------------------------------------------------------------------------------------------------------------------------------------------------------------------------------------------------------------------------------------------------------------------------------------------------------------------------------------------------------------------------------------|
| Address   | string-association | <p>The numerical private IP address and its preferred device.</p> <p>The agent verifies that the IP addresses are valid addresses. When you configure private IP addresses, ensure that the addresses do not have a leading 0 in any of the octets that comprise the IP address. The IP address must be in the format "X.X.X.1".</p> <p>In the following example, 0 and 1 indicates the ID of the device on which the IP address is hosted. If the device is unavailable, the agent automatically reconfigures the IP address on one of the available devices. The available device is determined based on the UseLoadBalance attribute setting.</p> <p>An example of the address attribute is as follows:</p> <pre>Address @sys1 = { "192.168.12.1" =0, "192.168.2.1" =0, "192.168.3.1" =1 } Address @sys2 = { "192.168.12.2" =0, "192.168.2.2" =0, "192.168.3.2" =1 }</pre> |
| Netmask   | string-association | <p>The netmask attribute is the numerical netmask for the private IP address.</p> <p>For example, Netmask = "255.255.255.0".</p>                                                                                                                                                                                                                                                                                                                                                                                                                                                                                                                                                                                                                                                                                                                                              |

**Table H-16** MultiPrivNIC agent attribute definitions (*continued*)

| Attribute             | Dimension          | Description                                                                                                                                                                                                                                                                                                                                                                                                                                                                                                                                             |
|-----------------------|--------------------|---------------------------------------------------------------------------------------------------------------------------------------------------------------------------------------------------------------------------------------------------------------------------------------------------------------------------------------------------------------------------------------------------------------------------------------------------------------------------------------------------------------------------------------------------------|
| UseLoadBalance        | integer-scalar     | <p>Value 0 or 1.</p> <p>In the event that the preferred device is unavailable and multiple links see maximum nodes during failover:</p> <ul style="list-style-type: none"> <li>■ Setting the attribute to 1 fails over the IP address to the device with lower traffic.</li> <li>■ Setting the attribute to 0 fails over the IP address to the device with lower network ID.</li> </ul> <p><b>Note:</b> If the preferred device becomes available, the IP address is failed back to the preferred device regardless of the value of UseLoadBalance.</p> |
| MTU                   | string-association | The maximum packet size, in bytes, that can be transmitted over LLT links. This value overrides the default MTU size of the network interface.                                                                                                                                                                                                                                                                                                                                                                                                          |
| EnableUseTroubleState | Boolean            | <p>Value 1 or 0.</p> <p>The value 1 indicates that the MultiPrivNIC agent fails over the IP address of a failed link even when the link state is marked <code>trouble</code>. The default value is 1.</p> <p>The value 0 indicates that the MultiPrivNIC agent fails over the IP address of a failed link only when the link state is marked <code>down</code>.</p>                                                                                                                                                                                     |

## States of the MultiPrivNIC agent

[Table H-17](#) lists the states of the MultiPrivNIC agent.

**Table H-17** States of the MultiPrivNIC agent

| State  | Description                                            |
|--------|--------------------------------------------------------|
| Online | Indicates that the private IP addresses are available. |

**Table H-17** States of the MultiPrivNIC agent (*continued*)

| State   | Description                                                                                                                       |
|---------|-----------------------------------------------------------------------------------------------------------------------------------|
| Unknown | Indicates the inability to determine the state of the resource due to incorrect attribute settings or other configuration issues. |

## Sample service group configuration with the MultiPrivNIC agent

Figure H-2 illustrates a sample service group configuration with the MultiPrivNIC agent.

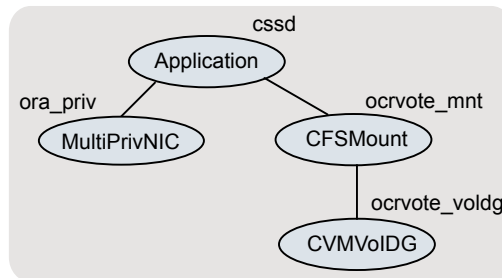
**Figure H-2** Basic service group configuration with MultiPrivNIC agent

The illustrated configuration shows the dependency of the CSSD resource on the private IP address configured as a MultiPrivNIC resource along with the OCR and voting disk volume and mount point dependencies.

For sample deployment scenarios, see the appendix *SF Oracle RAC deployment scenarios*.

## Type definition of the MultiPrivNIC resource

The following extract shows the type definition of the MultiPrivNIC resource in the MultiPrivNIC.cf file:

```

type MultiPrivNIC (
 static int MonitorTimeout = 300
 static int OfflineMonitorInterval = 60
 static int MonitorInterval = 10
 static str ArgList[] = { Device, DeviceTag, Address, NetMask,
 UseVirtualIP, GabPort, UseSystemList,
 ExcludeNode, MTU, UseLoadBalance,
 EnableUseTroubleState }
 static str Operations = None

```

```

 str Device{}
 str DeviceTag{}
 str Address{}
 str NetMask
 int UseVirtualIP
 str GabPort = o
 int UseSystemList
 int ExcludeNode[]
 int UseLoadBalance
 str MTU{}
 int EnableUseTroubleState = 1
)

```

## Sample configuration of the MultiPrivNIC resource

The following extract from the configuration file illustrates the configuration of a MultiPrivNIC resource.

```

MultiPrivNIC multi_priv (
 Critical = 0
 Device @sys1 = { lan1 = 0, lan2 = 1 }
 Device @sys2 = { lan1 = 0, lan2 = 1 }
 Address @sys1 = { "192.168.12.1" =0, "192.168.2.1" =0,
 "192.168.3.1" =1 }
 Address @sys2 = { "192.168.12.2" =0, "192.168.2.2" =0,
 "192.168.3.2" =1 }
 NetMask = "255.255.255.0"
 UseLoadBalance = 1
)

```

For more examples, see the sample configuration files located at  
/etc/VRTSvcs/conf/sample\_rac/.

In the above example, the interface next to the IP address is the preferred device for that particular IP address. If the same number of nodes are visible on each of the LLT interfaces, the IP addresses are configured on the preferred interfaces.

## CSSD agent

The CSSD agent starts, stops, and monitors Oracle Clusterware/Grid Infrastructure. It ensures that the OCR, the voting disk and the private IP address resources required by Oracle Clusterware/Grid Infrastructure are online before Oracle Clusterware/Grid Infrastructure starts. For this purpose, the cssd resource must be configured as a parent of the resources that manage the OCR, the voting disk, and

the private IP address used by Oracle Clusterware/Grid Infrastructure. Using the CSSD agent in SF Oracle RAC installations ensures adequate handling of inter-dependencies and thus prevents the premature startup of Oracle Clusterware/Grid Infrastructure, which causes cluster failures.

For Oracle RAC 10g Release 2 and Oracle RAC 11g Release 1, during system startup, the Oracle Clusterware init scripts invoke the clinfo script provided by Veritas software. The clinfo script ensures that the dependent resources of cssd resource configured under VCS are online, thus ensuring that the OCR, the voting disk, and the private IP address resources are online before the cssd resource comes online. After the underlying resources are online, the CSSD agent starts Oracle Clusterware.

For Oracle RAC 11g Release 2, the automatic startup of Oracle Clusterware/Grid Infrastructure must be disabled when the system starts. This prevents the premature startup of Oracle Clusterware/Grid Infrastructure during system startup. Thus, VCS ensures that Oracle Clusterware/Grid Infrastructure is started using the CSSD agent only when all the dependent resources of the cssd resource configured under VCS are online.

During system shutdown, the agent stops Oracle Clusterware/Grid Infrastructure before the OCR and voting disk resources are taken offline by VCS. This ensures that Oracle Clusterware/Grid Infrastructure does not panic the nodes in the cluster due to unavailability of the required resources.

---

**Note:** It is mandatory to use CSSD agent in SF Oracle RAC installations. You must configure the CSSD agent after installing Oracle Clusterware/Grid Infrastructure.

---

## Functions of the CSSD agent

[Table H-18](#) describes the functions of the CSSD agent.

**Table H-18** CSSD agent functions

| Function | Description                              |
|----------|------------------------------------------|
| Online   | Starts Oracle Clusterware.               |
| Offline  | Stops Oracle Clusterware.                |
| Monitor  | Checks the status of Oracle Clusterware. |

## Attributes of the CSSD agent

[Table H-19](#) lists the required attributes of the CSSD agent:



**Table H-19** Required attributes for CSSD resource

| Attribute Name | Required Value                    |
|----------------|-----------------------------------|
| Critical       | 0                                 |
| StartProgram   | /opt/VRTSvcs/rac/bin/cssd-online  |
| StopProgram    | /opt/VRTSvcs/rac/bin/cssd-offline |
| CleanProgram   | /opt/VRTSvcs/rac/bin/cssd-clean   |
| MonitorProgram | /opt/VRTSvcs/rac/bin/cssd-monitor |

## States of the CSSD agent

[Table H-20](#) describes the states of the CSSD agent.

**Table H-20** CSSD agent states

| State   | Description                                                                                                                       |
|---------|-----------------------------------------------------------------------------------------------------------------------------------|
| Online  | Indicates that Oracle Clusterware is running.                                                                                     |
| Offline | Indicates that Oracle Clusterware is not running.                                                                                 |
| Unknown | Indicates the inability to determine the state of the resource due to incorrect attribute settings or other configuration issues. |

## Sample service group configurations with the CSSD agent

[Figure H-3](#) illustrates a basic service group configuration with the CSSD agent.

**Figure H-3** Basic service group configuration with the CSSD agent

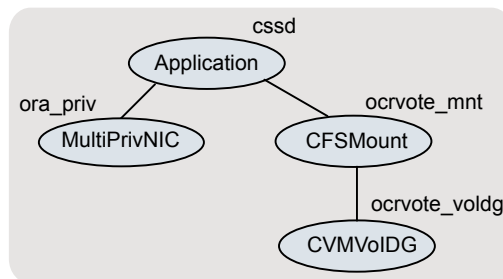

In this basic configuration, the OCR and voting disk volumes/mount points and IP addresses are configured under the CSSD resource. This ensures that these resources are online before the CSSD agent starts Oracle Clusterware.

---

**Note:** Depending on whether the Oracle database is started by Oracle Clusterware or by the VCS agent for Oracle, you must configure the Oracle database mounts such that they are online before the database starts.

---

For more sample configurations:

See [“Sample configuration files”](#) on page 557.

## Type definition of the CSSD resource

The CSSD agent is an application agent. You can determine the name of the CSSD resource.

The following extract shows the type definition of the CSSD resource in the `types.cf` file.

```
type Application (
 static keylist SupportedActions = { "program.vfd", "user.vfd", "cksum"
 static int IMF{} = { Mode = 3, MonitorFreq = 1, RegisterRetryLimit =
 static keylist IMFRegList = { MonitorProcesses, User, PidFiles, Monit
 static keylist RegList = { MonitorProcesses, User }
 static str ArgList[] = { State, IState, User, StartProgram, StopProgr
 CleanProgram, MonitorProgram, PidFiles, Moni
 EnvFile, UseSUDash }

 str User = root
 str StartProgram
 str StopProgram
 str CleanProgram
 str MonitorProgram
 str PidFiles[]
 str MonitorProcesses[]
 str EnvFile
 boolean UseSUDash
)
```

## Sample configuration of the CSSD resource

The following extract from the `main.cf` file illustrates a sample CSSD agent configuration:

```
Application cssd (
 Critical = 0
 StartProgram = "/opt/VRTSvcs/rac/bin/cssd-online"
 StopProgram = "/opt/VRTSvcs/rac/bin/cssd-offline"
 CleanProgram = "/opt/VRTSvcs/rac/bin/cssd-clean"
 MonitorProgram = "/opt/VRTSvcs/rac/bin/cssd-monitor"
)
```

## VCS agents for Oracle

The VCS agents for Oracle include the following agents that work together to make Oracle highly available:

- The Oracle agent monitors the Oracle database processes.  
 See [“Oracle agent functions”](#) on page 635.  
 See [“Resource type definition for the Oracle agent”](#) on page 641.
- The Netlsnr agent monitors the listener process.  
 See [“Netlsnr agent functions”](#) on page 649.
- The ASMDG agent monitors the Oracle ASM disk groups.  
 See [“ASMDG agent functions”](#) on page 654.  
 See [“Resource type definition for the ASMDG agent”](#) on page 655.

Refer to the *Veritas Cluster Server Agent for Oracle Installation and Configuration Guide* for more details on the agent functions and the resource types.

## Oracle agent functions

The Oracle agent monitors the database processes.

[Table H-21](#) lists the Oracle agent functions.

**Table H-21** Oracle agent functions

| Agent operation | Description                                                                                                                                                                                                                                                                                                                                                                               |
|-----------------|-------------------------------------------------------------------------------------------------------------------------------------------------------------------------------------------------------------------------------------------------------------------------------------------------------------------------------------------------------------------------------------------|
| Online          | <p>Starts the Oracle database.</p> <p>The agent uses the default startup option STARTUP_FORCE. For RAC clusters, you must manually change the value of the StartUpOpt attribute to SRVCTLSTART.</p> <p>If you set the option to SRVCTLSTART, the agent uses the following <code>srvctl</code> command to start the Oracle database:</p> <pre>srvctl start database -d database_name</pre> |

**Table H-21** Oracle agent functions (*continued*)

| Agent operation            | Description                                                                                                                                                                                                                                                                                                                                                                                                                                                                                                                                             |
|----------------------------|---------------------------------------------------------------------------------------------------------------------------------------------------------------------------------------------------------------------------------------------------------------------------------------------------------------------------------------------------------------------------------------------------------------------------------------------------------------------------------------------------------------------------------------------------------|
| Offline                    | <p>Stops the Oracle database.</p> <p>The agent uses the default shutdown option IMMEDIATE. For RAC clusters, you must manually change the value of the ShutDownOpt attribute to SRVCTLSTOP.</p> <p>If you set the option to SRVCTLSTOP, the agent uses the following <code>srvctl</code> command to stop the Oracle database:</p> <pre>srvctl stop database -d database_name</pre>                                                                                                                                                                      |
| Monitor                    | <p>Verifies the status of the Oracle processes. The Oracle agent provides two levels of monitoring: basic and detail.</p> <p>See <a href="#">“Monitor options for the Oracle agent”</a> on page 637.</p>                                                                                                                                                                                                                                                                                                                                                |
| oracle_imf_init            | <p>Initializes the agent to interface with the AMF kernel driver, which is the IMF notification module for Oracle agent. This function runs when the agent starts up.</p>                                                                                                                                                                                                                                                                                                                                                                               |
| oracle_imf_getnotification | <p>Gets notification about resource state changes. This function runs after the agent initializes with the AMF kernel module. This function continuously waits for notification and takes action on the resource upon notification.</p>                                                                                                                                                                                                                                                                                                                 |
| oracle_imf_register        | <p>Registers or unregisters resource entities with the AMF kernel module. This function runs for each resource after the resource goes into steady state (online or offline).</p>                                                                                                                                                                                                                                                                                                                                                                       |
| Clean                      | <p>Forcibly stops the Oracle database.</p> <p>If you set the shutdown option to SRVCTLSTOP, the agent uses the following <code>srvctl</code> command:</p> <pre>srvctl stop database -d database_name</pre> <p>If the process does not respond to the <code>srvctl</code> command, then the agent does the following:</p> <ul style="list-style-type: none"> <li>■ Scans the process table for the processes that are associated with the configured instance</li> <li>■ Kills the processes that are associated with the configured instance</li> </ul> |

**Table H-21** Oracle agent functions (*continued*)

| Agent operation | Description                                                                                                                                                                |
|-----------------|----------------------------------------------------------------------------------------------------------------------------------------------------------------------------|
| Info            | Provides the static and dynamic information about the state of the database.<br><br>See <a href="#">"Info entry point for SF Oracle RAC agent for Oracle"</a> on page 638. |
| Action          | Performs the predefined actions on a resource.<br><br>See <a href="#">"Action entry point for SF Oracle RAC agent for Oracle"</a> on page 639.                             |

## Monitor options for the Oracle agent

The Oracle agent provides two levels of monitoring: basic and detail. By default, the agent does a basic monitoring.

The basic monitoring mode has the following options:

- Process check
- Health check

The MonitorOption attribute of the Oracle resource determines whether the agent must perform basic monitoring in Process check or Health check mode.

[Table H-22](#) describes the basic monitoring options.

**Table H-22** Basic monitoring options

| Option         | Description                                                                                                                                                                                                                                                                                                                                                                           |
|----------------|---------------------------------------------------------------------------------------------------------------------------------------------------------------------------------------------------------------------------------------------------------------------------------------------------------------------------------------------------------------------------------------|
| 0<br>(Default) | Process check<br><br>The agent scans the process table for the ora_dbw0, ora_smon, ora_pmon, ora_lmon, and ora_lgwr processes to verify that Oracle is running.<br><br>In this mode, the agent also supports intelligent resource monitoring.                                                                                                                                         |
| 1              | Health check (supported on Oracle 10g and later)<br><br>The agent uses the Health Check APIs from Oracle to monitor the SGA and retrieve the information about the instance.<br><br>If you want to use the Oracle agent's intentional offline functionality, you must enable Health check monitoring.<br><br>The agent does not support intelligent resource monitoring in this mode. |

Review the following considerations if you want to configure basic monitoring:

- Basic monitoring of Oracle processes is user-specific. As a result, an Oracle instance started under the context of another user cannot be detected as online. For example, if an Oracle instance is started under the user "oraVRT" and the agent is configured for a user "oracle", the agent will not detect the instance started by "oraVRT" as online.

This could lead to situations where issuing a command to online a resource on a node might online an already running instance on that node (or any other node).

So, Symantec recommends that instances started outside SF Oracle RAC control be configured with the correct Owner attribute corresponding to the OS user for that instance.

Review the following considerations if you want to configure detail monitoring mode:

- If Oracle processes are online and you attempt to bring online the Oracle database, then basic monitoring detects and reports concurrency violation by the Oracle database on the standby node. However, detail monitoring does not detect concurrency violation because Oracle processes are online but the Oracle database is reported offline. Detail monitoring only reports concurrency violation when both processes and database are online.
- In the detail monitoring mode, the agent performs a transaction on a test table in the database to ensure that Oracle database functions properly. The agent uses this test table for internal purposes. Symantec recommends that you do not perform any other transaction on the test table.

## Info entry point for SF Oracle RAC agent for Oracle

The Veritas Cluster Server agent for Oracle supports the Info entry point, which provides static and dynamic information about the state of the database.

To invoke the Info entry point, type the following command:

```
hares -value resource ResourceInfo [system] \
[-clus cluster | -localclus]
```

The entry point retrieves the following static information:

- |                |              |                |
|----------------|--------------|----------------|
| ■ Version      | ■ InstanceNo | ■ InstanceName |
| ■ DatabaseName | ■ HostName   | ■ StartupTime  |
| ■ Parallel     | ■ Thread     | ■ InstanceRole |

The entry point retrieves the following dynamic information:

- InstanceStatus                      ■ Logins                                      ■ OpenMode
- LogMode                                ■ ShutdownPending                      ■ DatabaseStatus
- Shared Pool Percent free   ■ Buffer Hits Percent

You can add additional attributes by adding sql statements to the file `/opt/VRTSagents/ha/bin/Oracle/resinfo.sql`. For example:

```
select 'static:HostName:'||host_name from v$instance;
select 'dynamic:ShutdownPending:'||shutdown_pending from v$instance;
```

The format of the selected record must be as follows:

```
attribute_type:userkey_name:userkey_value
```

The variable *attribute\_type* can take the value static and/or dynamic.

## Action entry point for SF Oracle RAC agent for Oracle

The Veritas Cluster Server agent for Oracle supports the Action entry point, which enables you to perform predefined actions on a resource.

To perform an action on a resource, type the following command:

```
hares -action res token [-actionargs arg1 ...] \
[-sys system] [-clus cluster]
```

You can also add custom actions for the agent.

For further information, refer to the *Veritas Cluster Server Agent Developer's Guide*.

See [Table H-24](#) on page 640. describes the agent's predefined virtual fire drill actions.

[Table H-23](#) describes the agent's predefined actions.

**Table H-23**            Predefined agent actions

| Action                  | Description                                                                                                                |
|-------------------------|----------------------------------------------------------------------------------------------------------------------------|
| VRTS_GetInstanceName    | Retrieves the name of the configured instance. You can use this option for the Oracle and the Netlsnr resources.           |
| VRTS_GetRunningServices | Retrieves the list of processes that the agent monitors. You can use this option for the Oracle and the Netlsnr resources. |

**Table H-23** Predefined agent actions (*continued*)

| Action         | Description                                                                                     |
|----------------|-------------------------------------------------------------------------------------------------|
| DBRestrict     | Changes the database session to enable the RESTRICTED mode.                                     |
| DBUndoRestrict | Changes the database session to disable the RESTRICTED mode.                                    |
| DBSuspend      | Suspends a database.                                                                            |
| DBResume       | Resumes a suspended database.                                                                   |
| DBTbspBackup   | Backs up a tablespace; <code>actionargs</code> contains name of the tablespace to be backed up. |

[Table H-24](#) lists the virtual fire drill actions of the Veritas Cluster Server agent for Oracle lets you run infrastructure checks and fix specific errors.

**Table H-24** Predefined virtual fire drill actions

| Virtual fire drill action   | Description                                                                                                                                                                                                                                                                                                                                                                                                        |
|-----------------------------|--------------------------------------------------------------------------------------------------------------------------------------------------------------------------------------------------------------------------------------------------------------------------------------------------------------------------------------------------------------------------------------------------------------------|
| getid<br>(Oracle agent)     | Verifies that the Oracle Owner exists on the node.                                                                                                                                                                                                                                                                                                                                                                 |
| home.vfd<br>(Oracle agent)  | Verifies the following: <ul style="list-style-type: none"> <li>■ ORACLE_HOME is mounted on the node and corresponding entry is in the fstab.<br/>If the ORACLE_HOME is not mounted, the action entry point checks if any other resource has already mounted ORACLE_HOME.</li> <li>■ Pfile is provided and it exists on the node.</li> <li>■ Password file from \$ORACLE_HOME/dbs/orapw[SID] is present.</li> </ul> |
| owner.vfd<br>(Oracle agent) | Verifies the uid and gid of the Oracle Owner attribute. Checks if uid and gid of Owner attribute is the same on the node where the Oracle resource is currently ONLINE.                                                                                                                                                                                                                                            |
| pfile.vfd<br>(Oracle agent) | Checks for the presence of pfile or spfile on the local disk. If both pfile and spfile are not present, the agent function exits. If the Oracle resource is online in the cluster, the agent function logs a message that the spfile must be on the shared storage because the Oracle resource is online.                                                                                                          |



**Table H-24** Predefined virtual fire drill actions (*continued*)

| Virtual fire drill action       | Description                                                                                                                                             |
|---------------------------------|---------------------------------------------------------------------------------------------------------------------------------------------------------|
| tsnadmin.vfd<br>(Netlsnr agent) | Checks if listener.ora file is present. If the listener.ora file is not present, it checks if ORACLE_HOME is mounted and displays appropriate messages. |

## Resource type definition for the Oracle agent

The Oracle agent of the Veritas Cluster Server agent for Oracle is represented by the Oracle resource type in SF Oracle RAC.

The following extract shows the type definition of the Oracle resource in the OracleTypes.cf file.

```

type Oracle (
static str AgentDirectory = "/opt/VRTSagents/ha/bin/Oracle"
static keylist SupportedActions = { VRTS_GetInstanceName, VRTS_GetRunningServ
DBRestrict, DBUndoRestrict, DBResume, DBSuspend, DBTbspBackup, "home.vfd",
"owner.vfd", "getid", "pfile.vfd" }
static str ArgList[] = { Sid, Owner, Home, Pfile, StartUpOpt, ShutDownOpt, DB
DBAPword, EnvFile, AutoEndBkup, User, Pword, Table, MonScript,
Encoding, MonitorOption, DBName, ManagedBy }
static int IMF{} = { Mode=3, MonitorFreq=5, RegisterRetryLimit=3 }
static str IMFRegList[] = { Home, Owner, Sid, MonitorOption }
str Sid
str Owner
str Home
str Pfile
str StartUpOpt = STARTUP_FORCE
str ShutDownOpt = IMMEDIATE
str DBName
str ManagedBy = "ADMIN"
str DBAUser
str DBAPword
str EnvFile
boolean AutoEndBkup = 1
str MonScript = "./bin/Oracle/SqlTest.pl"
str User
str Pword
str Table
str Encoding

```

```

int MonitorOption = 0
static boolean IntentionalOffline = 0
)

```

## Attribute definition for the Oracle agent

Review the description of the Oracle agent attributes. The agent attributes are classified as required, optional, and internal.

[Table H-25](#) lists the required attributes. You must assign values to the required attributes.

**Table H-25** Required attributes for Oracle agent

| Required attributes | Type and dimension | Definition                                                                                                                                                                                                                                                                                                                              |
|---------------------|--------------------|-----------------------------------------------------------------------------------------------------------------------------------------------------------------------------------------------------------------------------------------------------------------------------------------------------------------------------------------|
| Sid                 | string-scalar      | The variable \$ORACLE_SID that represents the Oracle instance. The Sid is considered case-sensitive by the Oracle agent and by the Oracle database server.<br><br>For a policy managed database, the Sid attribute should be set to Sid prefix. See <a href="#">“About the Sid attribute in a policy managed database”</a> on page 648. |
| Owner               | string-scalar      | The Oracle user who has privileges to start or stop the database instance. The agent also supports LDAP users as Oracle user.                                                                                                                                                                                                           |
| Home                | string-scalar      | The \$ORACLE_HOME path to Oracle binaries and configuration files. For example, you could specify the path as /opt/ora_home.<br><br><b>Note:</b> Do not append a slash (/) at the end of the path.                                                                                                                                      |

[Table H-26](#) lists the optional attributes for Oracle agent. You can configure the optional attributes if necessary.

**Table H-26** Optional attributes for Oracle agent

| Optional Attributes | Type and Dimension | Definition                                                                                                                                                                                      |
|---------------------|--------------------|-------------------------------------------------------------------------------------------------------------------------------------------------------------------------------------------------|
| DBAUser             | string-scalar      | The database user who has sysdba privileges to start or stop the database.                                                                                                                      |
| DBAPword            | string-scalar      | Encrypted password for DBAUser.<br><br>Encrypt passwords only when entering them using the command-line. Passwords must be encrypted using the VCS Encrypt Utility (/opt/VRTSvcs/bin/vcscrypt). |

**Table H-26** Optional attributes for Oracle agent (*continued*)

| Optional Attributes | Type and Dimension | Definition                                                                                                                                                                                                                                                                                                                                                                                                               |
|---------------------|--------------------|--------------------------------------------------------------------------------------------------------------------------------------------------------------------------------------------------------------------------------------------------------------------------------------------------------------------------------------------------------------------------------------------------------------------------|
| StartUpOpt          | string-scalar      | <p>Startup options for the Oracle instance. This attribute can take the following values:</p> <ul style="list-style-type: none"> <li>■ STARTUP</li> <li>■ STARTUP_FORCE</li> <li>■ RESTRICTED</li> <li>■ RECOVERDB</li> <li>■ SRVCTLSTART</li> <li>■ SRVCTLSTART_RO</li> <li>■ CUSTOM</li> </ul> <p>Default is STARTUP_FORCE.</p>                                                                                        |
| ShutDownOpt         | string-scalar      | <p>Shut down options for the Oracle instance. This attribute can take the following values:</p> <ul style="list-style-type: none"> <li>■ IMMEDIATE</li> <li>■ TRANSACTIONAL</li> <li>■ SRVCTLSTOP</li> <li>■ SRVCTLSTOP_TRANSACT</li> <li>■ SRVCTLSTOP_ABORT</li> <li>■ SRVCTLSTOP_IMMEDIATE</li> <li>■ CUSTOM</li> </ul> <p>Default is IMMEDIATE.</p>                                                                   |
| EnvFile             | string-scalar      | <p>The full path name of the file that is sourced by the entry point scripts. This file contains the environment variables set by the user for the Oracle database server environment such as LD_LIBRARY_PATH, NLS_DATE_FORMAT, and so on.</p> <p>The syntax for the contents of the file depends on the login shell of Owner. File must be readable by Owner. The file must not contain any prompts for user input.</p> |
| Pfile               | string-scalar      | <p>The name of the initialization parameter file with the complete path of the startup profile.</p> <p>You can also use the server parameter file. Create a one-line text initialization parameter file that contains only the SPFILE parameter. See the Oracle documentation for more information.</p>                                                                                                                  |

**Table H-26** Optional attributes for Oracle agent (*continued*)

| Optional Attributes | Type and Dimension | Definition                                                                                                                                                                                                                                                                                                                                                                                                        |
|---------------------|--------------------|-------------------------------------------------------------------------------------------------------------------------------------------------------------------------------------------------------------------------------------------------------------------------------------------------------------------------------------------------------------------------------------------------------------------|
| AutoEndBkup         | integer-scalar     | Setting the AutoEndBkup attribute to a non-zero value takes the datafiles in the database out of the backup mode, during Online.<br><br>Default = 1                                                                                                                                                                                                                                                               |
| MonitorOption       | integer-scalar     | Monitor options for the Oracle instance. This attribute can take values 0 or 1. <ul style="list-style-type: none"><li>■ 0—Process check monitoring (recommended)</li><li>■ 1—Health check monitoring</li></ul> The agent supports intelligent resource monitoring only when this attribute value is set to 0.<br><br>Default = 0<br><br>See " <a href="#">Monitor options for the Oracle agent</a> " on page 637. |

**Table H-26** Optional attributes for Oracle agent (*continued*)

| Optional Attributes | Type and Dimension  | Definition                                                                                                                                                                                                                                                                                                                                                                                                                                                                                                                                                                                                                                                                                                                                                                                                                                                                                                                                                                                                                                                                                                                                                                                                                                                                                                                                                                                                                                                                                                                                                                                                                                                                                                                                                                                                                                                                                                                                                                                                                                                                                                                                                                                                                                                                                                                                                       |
|---------------------|---------------------|------------------------------------------------------------------------------------------------------------------------------------------------------------------------------------------------------------------------------------------------------------------------------------------------------------------------------------------------------------------------------------------------------------------------------------------------------------------------------------------------------------------------------------------------------------------------------------------------------------------------------------------------------------------------------------------------------------------------------------------------------------------------------------------------------------------------------------------------------------------------------------------------------------------------------------------------------------------------------------------------------------------------------------------------------------------------------------------------------------------------------------------------------------------------------------------------------------------------------------------------------------------------------------------------------------------------------------------------------------------------------------------------------------------------------------------------------------------------------------------------------------------------------------------------------------------------------------------------------------------------------------------------------------------------------------------------------------------------------------------------------------------------------------------------------------------------------------------------------------------------------------------------------------------------------------------------------------------------------------------------------------------------------------------------------------------------------------------------------------------------------------------------------------------------------------------------------------------------------------------------------------------------------------------------------------------------------------------------------------------|
| IMF                 | integer-association | <p>This resource-type level attribute determines whether the Oracle agent must perform intelligent resource monitoring. You can also override the value of this attribute at resource-level.</p> <p>This attribute includes the following keys:</p> <ul style="list-style-type: none"> <li>■ <b>Mode:</b> Define this attribute to enable or disable intelligent resource monitoring.</li> </ul> <p>Valid values are as follows:</p> <ul style="list-style-type: none"> <li>■ 0—Does not perform intelligent resource monitoring</li> <li>■ 1—Performs intelligent resource monitoring for offline resources and performs poll-based monitoring for online resources</li> <li>■ 2—Performs intelligent resource monitoring for online resources and performs poll-based monitoring for offline resources</li> <li>■ 3—Performs intelligent resource monitoring for both online and for offline resources</li> </ul> <p>Default: 3</p> <ul style="list-style-type: none"> <li>■ <b>MonitorFreq:</b> This key value specifies the frequency at which the agent invokes the monitor agent function. The value of this key is an integer.</li> </ul> <p>Default: 5</p> <p>You can set this key to a non-zero value for cases where the agent requires to perform both poll-based and intelligent resource monitoring. If the value is 0, the agent does not perform poll-based process check monitoring.</p> <p>After the resource registers with the AMF kernel driver, the agent calls the monitor agent function as follows:</p> <ul style="list-style-type: none"> <li>■ After every (MonitorFreq x MonitorInterval) number of seconds for online resources</li> <li>■ After every (MonitorFreq x OfflineMonitorInterval) number of seconds for offline resources</li> </ul> <ul style="list-style-type: none"> <li>■ <b>RegisterRetryLimit:</b> If you enable intelligent resource monitoring, the agent invokes the oracle_imf_register agent function to register the resource with the AMF kernel driver. The value of the RegisterRetryLimit key determines the number of times the agent must retry registration for a resource. If the agent cannot register the resource within the limit that is specified, then intelligent monitoring is disabled until the resource state changes or the value of the Mode key changes.</li> </ul> <p>Default: 3</p> |

Table H-26 Optional attributes for Oracle agent (*continued*)

| Optional Attributes | Type and Dimension | Definition                                                                                                                                                                                                                                                                                                                                                                                                                                                                                                                                                                                                                                                                                                                                                                                                                                                                                                                                  |
|---------------------|--------------------|---------------------------------------------------------------------------------------------------------------------------------------------------------------------------------------------------------------------------------------------------------------------------------------------------------------------------------------------------------------------------------------------------------------------------------------------------------------------------------------------------------------------------------------------------------------------------------------------------------------------------------------------------------------------------------------------------------------------------------------------------------------------------------------------------------------------------------------------------------------------------------------------------------------------------------------------|
| MonScript           | string-scalar      | <p>Pathname to the script provided for detail monitoring. The default (basic monitoring) is to monitor the database PIDs only.</p> <p><b>Note:</b> Detail monitoring is disabled if the value of the attribute MonScript is invalid or is set to an empty string.</p> <p>The pathname to the supplied detail monitor script is <code>/opt/VRTSagents/ha/bin/Oracle/SqlTest.pl</code>.</p> <p>MonScript also accepts a pathname relative to <code>/opt/VRTSagents/ha</code>. A relative pathname should start with <code>./</code>, as in the path <code>./bin/Oracle/SqlTest.pl</code>.</p>                                                                                                                                                                                                                                                                                                                                                 |
| User                | string-scalar      | Internal database user. Connects to the database for detail monitoring.                                                                                                                                                                                                                                                                                                                                                                                                                                                                                                                                                                                                                                                                                                                                                                                                                                                                     |
| LevelTwoMonitorFreq | integer-scalar     | <p>Specifies the frequency at which the agent for this resource type must perform second-level or detailed monitoring. You can also override the value of this attribute at resource-level.</p> <p>The value indicates the number of monitor cycles after which the agent will monitor Oracle in detail. For example, the value 5 indicates that the agent will monitor Oracle in detail every five online monitor intervals.</p> <p>If you manually upgraded to the SF Oracle RAC 6.0.1 agent, and if you had enabled detail monitoring in the previous version, then do the following:</p> <ul style="list-style-type: none"> <li>Set the value of the LevelTwoMonitorFreq attribute to the same value of that of the DetailMonitor attribute.</li> </ul> <p><b>Note:</b> If you set the AutoEndBkup attribute value to 0, then make sure that the LevelTwoMonitorFreq attribute value is 1 for detail monitoring.</p> <p>Default = 0</p> |
| Pword               | string-scalar      | <p>Encrypted password for internal database-user authentication.</p> <p>Encrypt passwords only when entering them using the command-line. Passwords must be encrypted using the VCS Encrypt Utility (<code>/opt/VRTSvcs/bin/vcscrypt</code>).</p>                                                                                                                                                                                                                                                                                                                                                                                                                                                                                                                                                                                                                                                                                           |
| Table               | string-scalar      | Table for update by <code>User/Pword</code> .                                                                                                                                                                                                                                                                                                                                                                                                                                                                                                                                                                                                                                                                                                                                                                                                                                                                                               |
| Encoding            | string-scalar      | <p>Specifies operating system encoding that corresponds to Oracle encoding for the displayed Oracle output.</p> <p>Default is "".</p>                                                                                                                                                                                                                                                                                                                                                                                                                                                                                                                                                                                                                                                                                                                                                                                                       |

Table H-26 Optional attributes for Oracle agent (*continued*)

| Optional Attributes | Type and Dimension | Definition                                                                                                                                                                                                                                                                                                                                                                                                                                                                                                                                                                                                                                                                                                                                                                                                                                                   |
|---------------------|--------------------|--------------------------------------------------------------------------------------------------------------------------------------------------------------------------------------------------------------------------------------------------------------------------------------------------------------------------------------------------------------------------------------------------------------------------------------------------------------------------------------------------------------------------------------------------------------------------------------------------------------------------------------------------------------------------------------------------------------------------------------------------------------------------------------------------------------------------------------------------------------|
| IntentionalOffline  |                    | <p>This resource-type level attribute defines how VCS reacts when Oracle is intentionally stopped outside of VCS control.</p> <p>If you stop Oracle out of VCS control, the agent behavior is as follows:</p> <ul style="list-style-type: none"> <li>■ 0—The Oracle agent registers a fault and initiates the failover of the service group.</li> <li>■ 1—The Oracle agent takes the Oracle resource offline when Health check monitoring is enabled.</li> </ul> <p>If Health check monitoring is not enabled, the agent registers a fault and initiates the failover of the service group.</p> <p><b>Note:</b> If you want to use the intentional offline functionality of the agent, you must set the value of the MonitorOption attribute as 1 to enable Health check monitoring.</p> <p>See the <i>Veritas Cluster Server Administrator's Guide</i>.</p> |
| DBName              | string-scalar      | Set this attribute only when the database is a policy managed RAC database. The value of this attribute must be set to the database unique name.                                                                                                                                                                                                                                                                                                                                                                                                                                                                                                                                                                                                                                                                                                             |
| ManagedBy           | string-scalar      | Default value for this attribute is ADMIN. In a policy managed RAC database this attribute must be set to POLICY.                                                                                                                                                                                                                                                                                                                                                                                                                                                                                                                                                                                                                                                                                                                                            |
| CleanRetryLimit     | integer-scalar     | <p>Set the CleanRetryLimit attribute to a finite value.</p> <p>When the attribute reaches the set limit, the agent sets the ADMIN_WAIT flag for the Oracle agent resource. It also sends the reason behind setting the flag to VCS. Based on the reason, VCS invokes the resadminwait trigger.</p> <p>Write a custom program that causes the system to panic if the ADMIN_WAIT flag is set for a specific reason. For the system to panic, implement the custom program as part of the resadminwait trigger script.</p> <p>For more information of CleanRetryLimit, refer to the <i>Veritas Cluster Server Agent Developer's Guide</i>.</p> <p>For more information on configuring triggers, refer to the <i>Veritas Cluster Server Administrator's Guide</i>.</p>                                                                                           |

Table H-27 lists the internal attribute for Oracle agent. This attribute is for internal use only. Symantec recommends not to modify the value of this attribute.

**Table H-27** Internal attributes for Oracle agent

| Optional Attributes | Type and Dimension | Definition                                                                                                                                 |
|---------------------|--------------------|--------------------------------------------------------------------------------------------------------------------------------------------|
| AgentDirectory      | static-string      | Specifies the location of binaries, scripts, and other files related to the Oracle agent.<br><br>Default is /opt/VRTSagents/ha/bin/Oracle. |

## About the Sid attribute in a policy managed database

The SID attribute is a required attribute. This section provides information to define the SID attribute in a policy managed database.

The SID prefix comprises of the first 8 alphanumeric characters of the database unique name. It can be a combination of letters a-z; uppercase and lowercase and numbers 0-9.

The SID prefix cannot have operating system special characters. Therefore, avoid the use of special characters in the first 8 characters of the database unique name. Special characters are omitted if used in the first 8 characters. There is a single SID prefix for every database. The SID prefix for a database must be unique within the cluster.

For an Oracle RAC database, each instance has a unique identifier, ORACLE\_SID, which consists of the SID prefix and an instance number. The ORACLE\_SID for Oracle RAC database instances is generated differently, depending on how you choose to manage the database. If you select a policy-managed database, then Oracle generates the SID in the format name\_#, where name is the first eight alphanumeric characters of DB\_UNIQUE\_NAME, and # is the instance number. If you select an admin-managed database, then DBCA generates the SID for the instance names in advance, and the SID is in the format name#.

To find the Sid prefix name, run the following command:

```
${GRID_HOME}/bin/crsctl status resource ora.${DBName}.db -f | grep
GEN_USR_ORA_INST_NAME@ | tail -1 | sed 's/.*=//' | sed 's/_[0-9]$//',
```

where *GRID\_HOME* is grid home path and *DBName* is the database unique name.

---

**Note:** When a policy managed database is created, the Sid prefix is displayed on the confirmation page of the installation procedure.

---

See [“Attribute definition for the Oracle agent”](#) on page 642.



## Netlsnr agent functions

The listener is a server process that listens to incoming client connection requests and manages traffic to the database. The Netlsnr agent brings the listener services online, monitors their status, and takes them offline.

The Netlsnr agent is IMF-aware.

[Table H-28](#) lists the Netlsnr agent functions.

**Table H-28** Netlsnr agent functions

| Agent operation                          | Description                                                                                                                                                                                                                                                                                                                                                                                                                                                                                             |
|------------------------------------------|---------------------------------------------------------------------------------------------------------------------------------------------------------------------------------------------------------------------------------------------------------------------------------------------------------------------------------------------------------------------------------------------------------------------------------------------------------------------------------------------------------|
| Online                                   | Starts the listener process by using the following command:<br><br><code>lsnrctl start \$LISTENER</code>                                                                                                                                                                                                                                                                                                                                                                                                |
| Offline                                  | Stops the listener process by using the following command:<br><br><code>lsnrctl stop \$LISTENER</code><br><br>If the listener is configured with a password, the agent uses the password to stop the listener.                                                                                                                                                                                                                                                                                          |
| Monitor                                  | Verifies the status of the listener process.<br><br>The Netlsnr agent provides two levels of monitoring, basic and detail: <ul style="list-style-type: none"> <li>■ In the basic monitoring mode, the agent scans the process table for the <code>tnslsnr</code> process to verify that the listener process is running.</li> <li>■ In the detail monitoring mode, the agent uses the <code>lsnrctl status \$LISTENER</code> command to verify the status of the Listener process. (Default)</li> </ul> |
| <code>netlsnr_imf_init</code>            | Initializes the agent to interface with the AMF kernel driver, which is the IMF notification module for Netlsnr agent. This function runs when the agent starts up.                                                                                                                                                                                                                                                                                                                                     |
| <code>netlsnr_imf_getnotification</code> | Gets notification about resource state change. This function runs after the agent registers with the AMF kernel module. This function continuously waits for notification and takes action on the resource upon notification.                                                                                                                                                                                                                                                                           |
| <code>netlsnr_imf_register</code>        | Registers or unregisters resource entities with the AMF kernel module. This function runs for each resource after the resource goes into steady state (online or offline).                                                                                                                                                                                                                                                                                                                              |
| Clean                                    | Scans the process table for <code>tnslsnr \$LISTENER</code> and kills it.                                                                                                                                                                                                                                                                                                                                                                                                                               |

**Table H-28** Netlsnr agent functions (*continued*)

| Agent operation | Description                                                                                                                                    |
|-----------------|------------------------------------------------------------------------------------------------------------------------------------------------|
| Action          | Performs the predefined actions on a resource.<br><br>See <a href="#">“Action entry point for SF Oracle RAC agent for Oracle”</a> on page 639. |

## Resource type definition for the Netlsnr agent

The Netlsnr agent of the Veritas Cluster Server agent for Oracle is represented by the Netlsnr resource type in SF Oracle RAC.

```

type Netlsnr (
 static str AgentDirectory = "/opt/VRTSagents/ha/bin/Netlsnr"
 static keylist SupportedActions = { VRTS_GetInstanceName,
 VRTS_GetRunningServices, "tnsadmin.vfd" }
 static str ArgList[] = { Owner, Home, TnsAdmin, Listener,
 EnvFile, MonScript, LsnrPwd, Encoding }
 static int IMF{} = { Mode=3, MonitorFreq=5, RegisterRetryLimit=3 }
 static str IMFRegList[] = { Home, Owner, Listener }
 str Owner
 str Home
 str TnsAdmin
 str Listener = "LISTENER"
 str EnvFile
 str MonScript = "./bin/Netlsnr/LsnrTest.pl"
 str LsnrPwd
 str Encoding
 static boolean IntentionalOffline = 0
)

```

## Attribute definition for the Netlsnr agent

Review the description of the Netlsnr agent attributes. The agent attributes are classified as required, optional, and internal.

[Table H-29](#) lists the required attributes for Netlsnr agent. You must assign values to the required attributes.

**Table H-29** Required attributes for Netlsnr agent

| Required attributes | Type and dimension | Definition                                                                                                                                                                        |
|---------------------|--------------------|-----------------------------------------------------------------------------------------------------------------------------------------------------------------------------------|
| Owner               | string-scalar      | The Oracle user who has privileges to start or stop the listener process.<br>The agent also supports LDAP users as Oracle user.                                                   |
| Home                | string-scalar      | The \$ORACLE_HOME path to Oracle binaries and configuration files. For example, you could specify the path as /opt/ora_home.<br>Do not append a slash (/) at the end of the path. |

[Table H-30](#) lists the optional attributes for Netlsnr agent. You can configure the optional attributes if necessary.

**Table H-30** Optional attributes for Netlsnr agent

| Optional attributes | Type and dimension | Definition                                                                                                                                                                                                                                                                                                                                                                                          |
|---------------------|--------------------|-----------------------------------------------------------------------------------------------------------------------------------------------------------------------------------------------------------------------------------------------------------------------------------------------------------------------------------------------------------------------------------------------------|
| TnsAdmin            | string-scalar      | The \$TNS_ADMIN path to directory in which the Listener configuration file resides (listener.ora).<br>Default is /var/opt/oracle.                                                                                                                                                                                                                                                                   |
| Listener            | string-scalar      | Name of Listener. The name for Listener is considered case-insensitive by the Netlsnr agent and the Oracle database server.<br>Default is LISTENER.                                                                                                                                                                                                                                                 |
| LsnrPwd             | string-scalar      | The SF Oracle RAC encrypted password used to stop and monitor the listener. This password is set in the Listener configuration file.<br>Encrypt passwords only when entering them using the command-line. Passwords must be encrypted using the SF Oracle RAC Encrypt utility.                                                                                                                      |
| EnvFile             | string-scalar      | Specifies the full path name of the file that is sourced by the entry point scripts. This file contains the environment variables set by the user for the Oracle listener environment such as LD_LIBRARY_PATH and so on.<br>The syntax for the contents of the file depends on the login shell of Owner. This file must be readable by Owner. The file must not contain any prompts for user input. |

**Table H-30** Optional attributes for Netlsnr agent (*continued*)

| Optional attributes | Type and dimension  | Definition                                                                                                                                                                                                                                                                                                                                                                                                                                                                                                                                                                                                                                                                                                                                                                                                                                                                                                                                                                                                                                                                                                                                                                                                                                                                                                                                                                                                                                                                                                                                                                                                                                                                                                                                                                                                                                                                                                                                                                                                                                                                                                                                                                                                                                                                                                              |
|---------------------|---------------------|-------------------------------------------------------------------------------------------------------------------------------------------------------------------------------------------------------------------------------------------------------------------------------------------------------------------------------------------------------------------------------------------------------------------------------------------------------------------------------------------------------------------------------------------------------------------------------------------------------------------------------------------------------------------------------------------------------------------------------------------------------------------------------------------------------------------------------------------------------------------------------------------------------------------------------------------------------------------------------------------------------------------------------------------------------------------------------------------------------------------------------------------------------------------------------------------------------------------------------------------------------------------------------------------------------------------------------------------------------------------------------------------------------------------------------------------------------------------------------------------------------------------------------------------------------------------------------------------------------------------------------------------------------------------------------------------------------------------------------------------------------------------------------------------------------------------------------------------------------------------------------------------------------------------------------------------------------------------------------------------------------------------------------------------------------------------------------------------------------------------------------------------------------------------------------------------------------------------------------------------------------------------------------------------------------------------------|
| IMF                 | integer-association | <p>This resource-type level attribute determines whether the Netlsnr agent must perform intelligent resource monitoring. You can also override the value of this attribute at resource-level.</p> <p>This attribute includes the following keys:</p> <ul style="list-style-type: none"> <li>■ <b>Mode:</b> Define this attribute to enable or disable intelligent resource monitoring.</li> </ul> <p>Valid values are as follows:</p> <ul style="list-style-type: none"> <li>■ 0—Does not perform intelligent resource monitoring</li> <li>■ 1—Performs intelligent resource monitoring for offline resources and performs poll-based monitoring for online resources</li> <li>■ 2—Performs intelligent resource monitoring for online resources and performs poll-based monitoring for offline resources</li> <li>■ 3—Performs intelligent resource monitoring for both online and for offline resources</li> </ul> <p>Default: 3</p> <ul style="list-style-type: none"> <li>■ <b>MonitorFreq:</b> This key value specifies the frequency at which the agent invokes the monitor agent function. The value of this key is an integer.</li> </ul> <p>Default: 5</p> <p>You can set this attribute to a non-zero value in some cases where the agent requires to perform poll-based resource monitoring in addition to the intelligent resource monitoring.</p> <p>After the resource registers with the AMF kernel driver, the agent calls the monitor agent function as follows:</p> <ul style="list-style-type: none"> <li>■ After every (MonitorFreq x MonitorInterval) number of seconds for online resources</li> <li>■ After every (MonitorFreq x OfflineMonitorInterval) number of seconds for offline resources</li> </ul> <ul style="list-style-type: none"> <li>■ <b>RegisterRetryLimit:</b> If you enable intelligent resource monitoring, the agent invokes the netlsnr_imf_register agent function to register the resource with the AMF kernel driver. The value of the RegisterRetryLimit key determines the number of times the agent must retry registration for a resource. If the agent cannot register the resource within the limit that is specified, then intelligent monitoring is disabled until the resource state changes or the value of the Mode key changes.</li> </ul> <p>Default: 3</p> |

**Table H-30** Optional attributes for Netlsnr agent (*continued*)

| Optional attributes | Type and dimension | Definition                                                                                                                                                                                                                                                                                                                                                                                                                                                                                                                                          |
|---------------------|--------------------|-----------------------------------------------------------------------------------------------------------------------------------------------------------------------------------------------------------------------------------------------------------------------------------------------------------------------------------------------------------------------------------------------------------------------------------------------------------------------------------------------------------------------------------------------------|
| MonScript           | string-scalar      | <p>Pathname to the script provided for detail monitoring. By default, the detail monitoring is enabled to monitor the listener process.</p> <p><b>Note:</b> If the value of the attribute MonScript is set to an empty string, the agent disables detail monitoring.</p> <p>The pathname to the supplied detail monitoring script is /opt/VRTSagents/ha/bin/Netlsnr/LsnrTest.pl.</p> <p>MonScript also accepts a pathname relative to /opt/VRTSagents/ha. A relative pathname should start with "./", as in the path ./bin/Netlsnr/LsnrTest.pl.</p> |
| LevelTwoMonitorFreq | integer-scalar     | <p>Specifies the frequency at which the agent for this resource type must perform second-level or detailed monitoring.</p> <p>If you enabled detail monitoring, then set the value of the LevelTwoMonitorFreq attribute.</p> <p>Default = 0</p>                                                                                                                                                                                                                                                                                                     |
| Encoding            | string-scalar      | <p>Specifies operating system encoding that corresponds to Oracle encoding for the displayed Oracle output.</p> <p>Default is "".</p>                                                                                                                                                                                                                                                                                                                                                                                                               |
| IntentionalOffline  |                    | <p>For future use.</p> <p>Do not change the value of this attribute.</p> <p>Default = 0</p>                                                                                                                                                                                                                                                                                                                                                                                                                                                         |

[Table H-31](#) lists the internal attribute for Netlsnr agent. This attribute is for internal use only. Symantec recommends not to modify the value of this attribute.

**Table H-31** Internal attributes for Netlsnr agent

| Optional Attributes | Type and Dimension | Definition                                                                                                                                          |
|---------------------|--------------------|-----------------------------------------------------------------------------------------------------------------------------------------------------|
| AgentDirectory      | static-string      | <p>Specifies the location of binaries, scripts, and other files related to the Netlsnr agent.</p> <p>Default is /opt/VRTSagents/ha/bin/Netlsnr.</p> |

## ASMDG agent functions

The ASMDG agent mounts the ASM disk groups that the Oracle databases use, monitors the status, unmounts the ASM disk groups.

You must have specified the disk group names in the DiskGroups attribute of the ASMDG agent.

[Table H-32](#) lists the ASMDG agent operations.

**Table H-32** ASMDG agent operations

| Agent operation | Description                                                                                                                                                                                                                                                                                                                                                                                                                                           |
|-----------------|-------------------------------------------------------------------------------------------------------------------------------------------------------------------------------------------------------------------------------------------------------------------------------------------------------------------------------------------------------------------------------------------------------------------------------------------------------|
| Online          | <p>Mounts the specified Oracle ASM disk groups to an ASM instance by using the following SQL command:</p> <pre>alter diskgroup dg_name1, dg_name2 mount</pre>                                                                                                                                                                                                                                                                                         |
| Offline         | <p>Unmounts the specified Oracle ASM disk groups from an ASM instance by using the following SQL command:</p> <pre>alter diskgroup dg_name1, dg_name2 dismount</pre> <p><b>Note:</b> The following Oracle message appears in the VCS log when an ASM instance with no ASM disk groups mounted is shut down:<br/>ORA-15100: invalid or missing diskgroup name</p>                                                                                      |
| Monitor         | <p>Verifies the status of the specified ASM disk groups.</p> <p>The disk groups can be in one of the following states:</p> <ul style="list-style-type: none"> <li>■ mounted</li> <li>■ dismounted</li> <li>■ unknown</li> <li>■ broken</li> <li>■ connected</li> </ul> <p>If multiple ASM disk groups are configured for a resource, then the ASMDG agent returns the resource state considering the status of all the specified ASM disk groups.</p> |
| Clean           | <p>Forcibly unmounts the Oracle ASM disk groups by using the following SQL command:</p> <pre>alter diskgroup dg_name1, dg_name2 dismount force</pre>                                                                                                                                                                                                                                                                                                  |

## Resource type definition for the ASMDG agent

The ASMDG agent of the Veritas Cluster Server agent for Oracle is represented by the ASMDG resource type in SF Oracle RAC. The following extract shows the type definition of the ASMDG resource in the OracleASMTypes.cf file.

```
type ASMDG (
 static str AgentDirectory = "/opt/VRTSagents/ha/bin/ASMDG"
 static str ArgList[] = { Sid, Owner, Home, DBAUser,
 DBAPword, DiskGroups, EnvFile, Encoding }
 str Sid
 str Owner
 str Home
 str DBAUser
 str DBAPword
 keylist DiskGroups
 str EnvFile
 str Encoding
)
```

### Attribute definition for the ASMDG agent

Review the description of the ASMDG agent attributes. The agent attributes are classified as required, optional, and internal.

[Table H-33](#) lists the required attributes. You must assign values to the required attributes.

**Table H-33** Required attributes for ASMDG agent

| Required attributes | Type and dimension | Definition                                                                                                                           |
|---------------------|--------------------|--------------------------------------------------------------------------------------------------------------------------------------|
| DiskGroups          | keylist            | The ASM disk groups, where you store the Oracle database files.                                                                      |
| Sid                 | string-scalar      | The variable \$ORACLE_SID that represents the ASM instance.                                                                          |
| Owner               | string-scalar      | The Oracle user who has privileges to mount or unmount the ASM disk group.<br><br>The agent also supports LDAP users as Oracle user. |

**Table H-33** Required attributes for ASMDG agent (*continued*)

| Required attributes | Type and dimension | Definition                                                                                                                                                                                                    |
|---------------------|--------------------|---------------------------------------------------------------------------------------------------------------------------------------------------------------------------------------------------------------|
| Home                | string-scalar      | <p>The \$ORACLE_HOME path to Oracle ASM binaries and configuration files. For example, you could specify the path as /opt/ora_home.</p> <p><b>Note:</b> Do not append a slash (/) at the end of the path.</p> |

Table H-34 lists the optional attributes for ASMDG agent. You can configure the optional attributes if necessary.

**Table H-34** Optional attributes for ASMDG agent

| Optional Attributes | Type and Dimension | Definition                                                                                                                                                                                                                                                                                                                                                                                                               |
|---------------------|--------------------|--------------------------------------------------------------------------------------------------------------------------------------------------------------------------------------------------------------------------------------------------------------------------------------------------------------------------------------------------------------------------------------------------------------------------|
| DBAUser             | string-scalar      | The ASM user who has sysasm privileges to start or stop the ASM instance. You can create ASM users for Oracle 11g R1 and later.                                                                                                                                                                                                                                                                                          |
| DBAPword            | string-scalar      | <p>Encrypted password for DBAUser.</p> <p>Encrypt passwords only when entering them using the command-line. Passwords must be encrypted using the SF Oracle RAC Encrypt utility.</p>                                                                                                                                                                                                                                     |
| EnvFile             | string-scalar      | <p>The full path name of the file that is sourced by the entry point scripts. This file contains the environment variables set by the user for the Oracle database server environment such as LD_LIBRARY_PATH, NLS_DATE_FORMAT, and so on.</p> <p>The syntax for the contents of the file depends on the login shell of Owner. File must be readable by Owner. The file must not contain any prompts for user input.</p> |



**Table H-34** Optional attributes for ASMDG agent (*continued*)

| Optional Attributes | Type and Dimension | Definition                                                                                                              |
|---------------------|--------------------|-------------------------------------------------------------------------------------------------------------------------|
| Encoding            | string-scalar      | Specifies operating system encoding that corresponds to Oracle encoding for the displayed Oracle output. Default is "". |

[Table H-35](#) lists the internal attribute for ASMDG agent. This attribute is for internal use only. Symantec recommends not to modify the value of this attribute.

**Table H-35** Internal attributes for ASMDG agent

| Optional Attributes | Type and Dimension | Definition                                                                                                                                  |
|---------------------|--------------------|---------------------------------------------------------------------------------------------------------------------------------------------|
| AgentDirectory      | static-string      | Specifies the location of binaries, scripts, and other files related to the ASMDG agent.<br><br>Default is<br>/opt/VRTSagents/ha/bin/ASMDG. |

## CRSResource agent

The `CRSResource` agent provides an alternative mechanism for monitoring the Oracle database in the absence of the VCS Oracle agent. It checks the status of the Oracle Clusterware resources, which include the Oracle database instance, the listener, and the virtual IP address (VIP). The agent supports multiple database configurations and ensures that the Oracle database is online and available to an application when it starts.

---

**Note:** For Oracle RAC 11g Release 2: The `CRSResource` agent is supported only in admin-managed database environments.

---

## Functions of the CRSResource agent

[Table H-36](#) describes the functions of the `CRSResource` agent.

**Table H-36** CRSResource agent entry points

| Entry point | Description                                                                                                                                                                                                                                                                  |
|-------------|------------------------------------------------------------------------------------------------------------------------------------------------------------------------------------------------------------------------------------------------------------------------------|
| Monitor     | <p>Checks the status of the following Oracle Clusterware resources:</p> <ul style="list-style-type: none"> <li>■ Oracle database</li> <li>■ Virtual IP address</li> <li>■ Listener</li> </ul> <p>The monitor script checks the status of the resources every 60 seconds.</p> |

## States of the CRSResource agent

[Table H-37](#) lists the states of the CRSResource agent.

**Table H-37** States of the CRSResource agent

| State   | Description                                                                                                                        |
|---------|------------------------------------------------------------------------------------------------------------------------------------|
| Online  | Indicates that the Oracle database, VIP, and listener are running.                                                                 |
| Faulted | Indicates that the Oracle database, VIP, and listener are not running or are faulted.                                              |
| Unknown | Indicates the inability to determine the state of the resource due to incorrect attributes settings or other configuration issues. |

## Attributes of the CRSResource agent

**Table H-38** Attributes of the CRSResource agent

| Attribute | Dimension     | Description                                                                                                                                                                                           |
|-----------|---------------|-------------------------------------------------------------------------------------------------------------------------------------------------------------------------------------------------------|
| ResType   | string-scalar | <p>Indicates the type of the Oracle Clusterware resource.</p> <p>The types of resources are as follows:</p> <ul style="list-style-type: none"> <li>■ DB</li> <li>■ VIP</li> <li>■ Listener</li> </ul> |

**Table H-38** Attributes of the CRSResource agent (*continued*)

| Attribute | Dimension     | Description                                                                                                                                                                                                           |
|-----------|---------------|-----------------------------------------------------------------------------------------------------------------------------------------------------------------------------------------------------------------------|
| DBHome    | string-scalar | The path to ORACLE_HOME containing the Oracle binaries and configuration files. For example, you could specify the path as /app/oracle/orahome.<br><br><b>Note:</b> Do not append a slash (/) at the end of the path. |
| CRSHome   | string-scalar | The path to CRS_HOME containing the Oracle Clusterware binaries.                                                                                                                                                      |
| DBName    | string-scalar | The name of the database on which the services are configured.<br><br>This attribute is optional if you are configuring CRSResource to monitor VIP or listener.                                                       |
| SID       | string-scalar | The name of the Oracle instance in the variable \$ORACLE_SID. The SID is case-sensitive.<br><br>This attribute is optional if you are configuring CRSResource to monitor VIP or listener.                             |
| Owner     | string-scalar | The name of the user for the Oracle database.<br><br>This attribute is optional if you are configuring CRSResource to monitor VIP or listener.                                                                        |

## VCS service group dependencies with the CRSResource agent

In a service group configuration with the CRSResource agent, Oracle Clusterware controls the database. An online local firm dependency exists between the groups—Application group, Oracle Clusterware group, and the CVM group.

[Figure H-4](#) shows a schematic illustration of the service group dependencies.

**Figure H-4** Service group dependencies with CRSResource agent

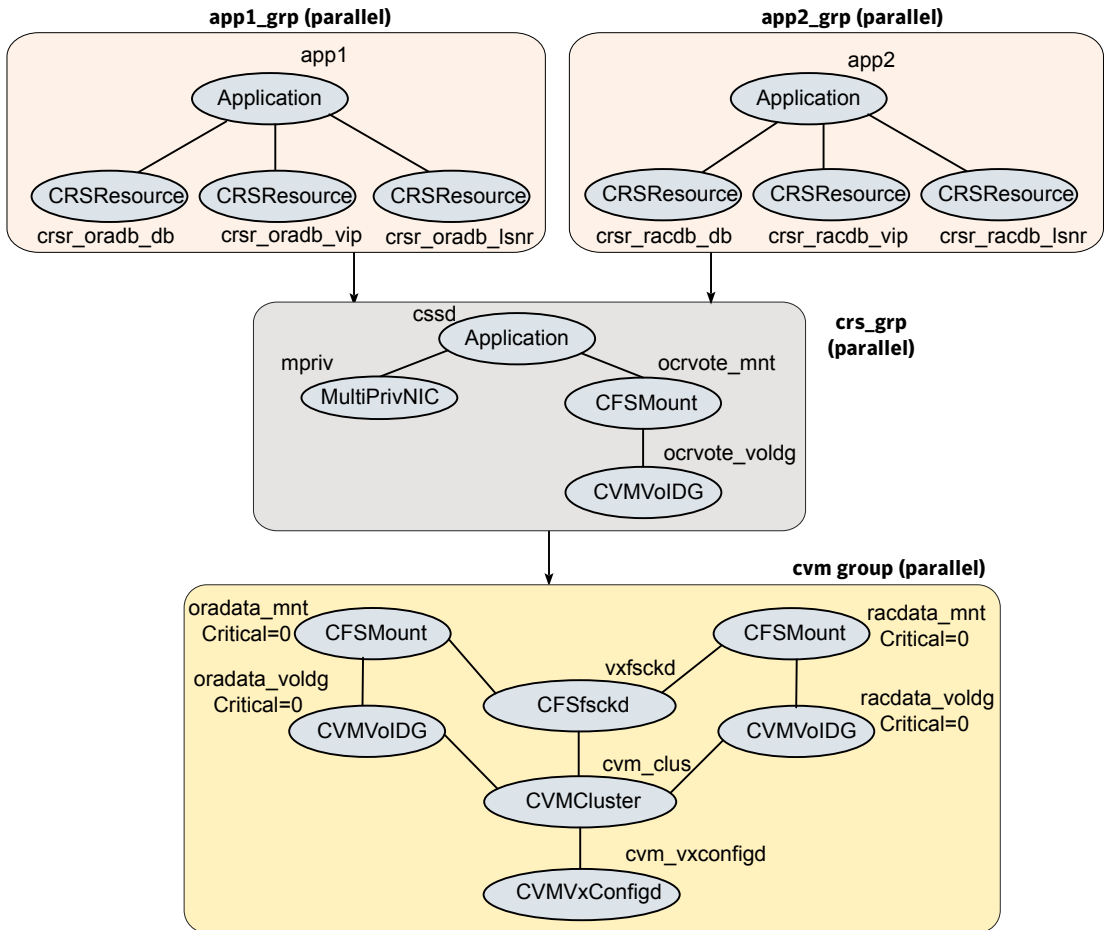

In the configuration:

- When the system starts, the CVM group brings up the volume and mount points for the databases. The Oracle Clusterware group brings up the OCR and voting disk, configures the private IP address for Oracle Clusterware, and starts Oracle Clusterware. Oracle Clusterware starts the database and the application is brought online. CRSResource comes online when the Oracle Clusterware resources (database/VIP/listener) are started by Oracle Clusterware.

---

**Note:** When the system starts, all volumes and mount points **MUST** be online for the dependent service groups to be online.

---

- The oradata\_mnt and oradata\_voldg resources are configured as non-critical resources (critical=0) for managing failure scenarios. See “[How CRSResource agent handles failures](#)” on page 661.
- When CRSResource faults for any of the Oracle Clusterware resources, the application is brought offline.

The limitations of this configuration are as follows:

- The CFSMount and CVMVoIDg resources can not be set as critical resources in the group.  
If the mount points and volume disk groups for all the databases are configured as critical in a single service group, then failure of any of them results in the whole group being FAULTED or brought offline. To ensure that a resource failure does not affect other resources in the group, the attribute Critical is set to zero for the CFSMount and CVMVoIDg resources.  
However, if any of the database mounts fail to come online or a volume does not start, the whole service group fails to come online.
- CRSResource reports as FAULTED until Oracle Clusterware brings up the database instance, VIP, and listener. Even after Oracle Clusterware starts the database instance, VIP and listener, CRSResource remains in the FAULTED state for the OfflineMonitorInterval period. The status of CRSResource cannot be changed.

## How CRSResource agent handles failures

The CRSResource agent ensures that faults in the resources of an application do not adversely impact other applications running on the system. To isolate failures, the oradata\_mnt and oradata\_voldg resources are configured as non-critical resources (critical=0). This ensures that storage issues in either of these resources do not affect the other databases and the dependent application continues to be online.

---

**Note:** The resources are considered non-critical only for the purpose of managing failure scenarios.

---

[Figure H-5](#) illustrates a failure scenario.

**Figure H-5** How CRSResource agent handles failures

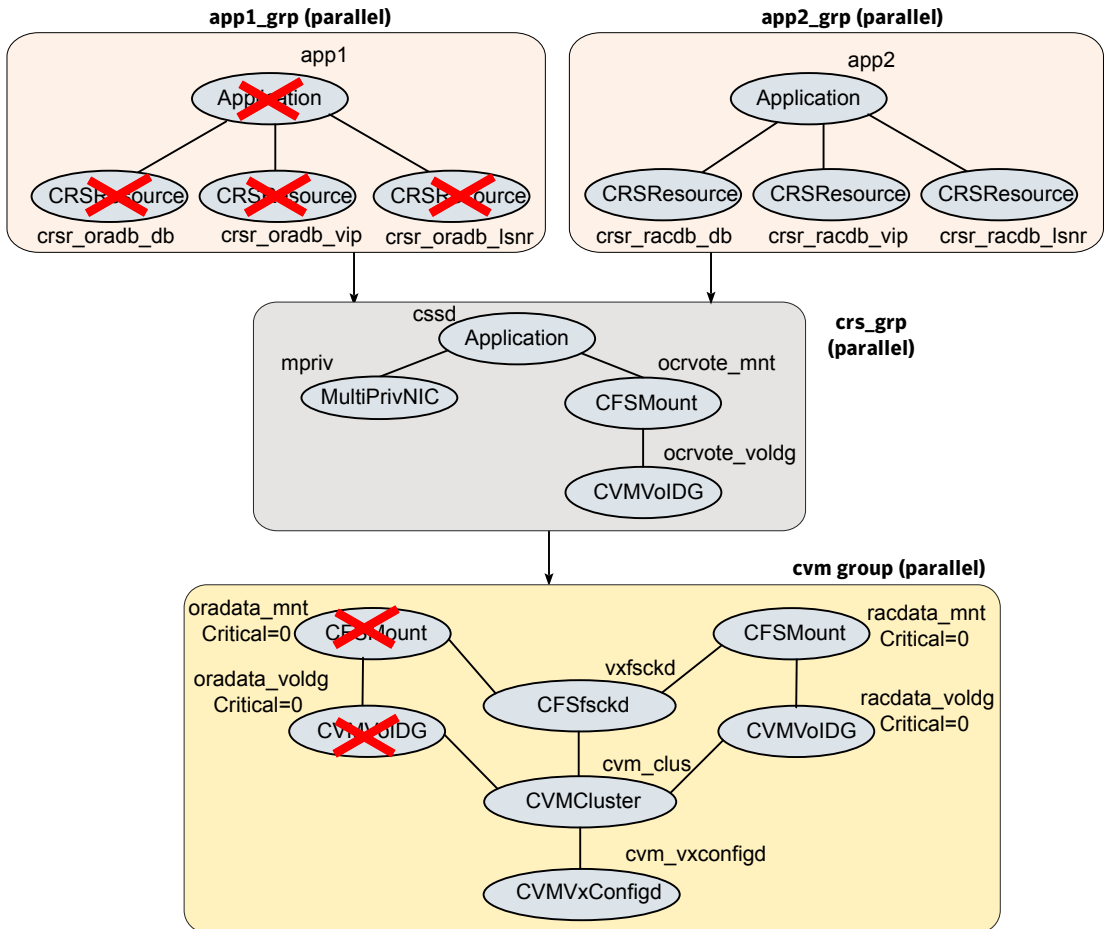

## Fault configurations with CRSResource agent

This section discusses scenarios that cause CRSResource to report FAULTED.

### Scenario 1: CRSResource fault at system startup

1. The CVM group brings online the volume and mount points for the databases when the system starts.
2. The Oracle Clusterware group brings up the OCR and voting disk, configures the private IP address for Oracle Clusterware and starts Oracle Clusterware.

Oracle Clusterware is unable to bring the database or other resources online within the start duration configured in the agent.

3. The agent starts the monitoring operation after the set duration.

If the Oracle Clusterware resources are not brought online yet, the CRSResource appears faulted.

Figure H-6 illustrates the scenario.

**Figure H-6** CRSResource fault at system startup

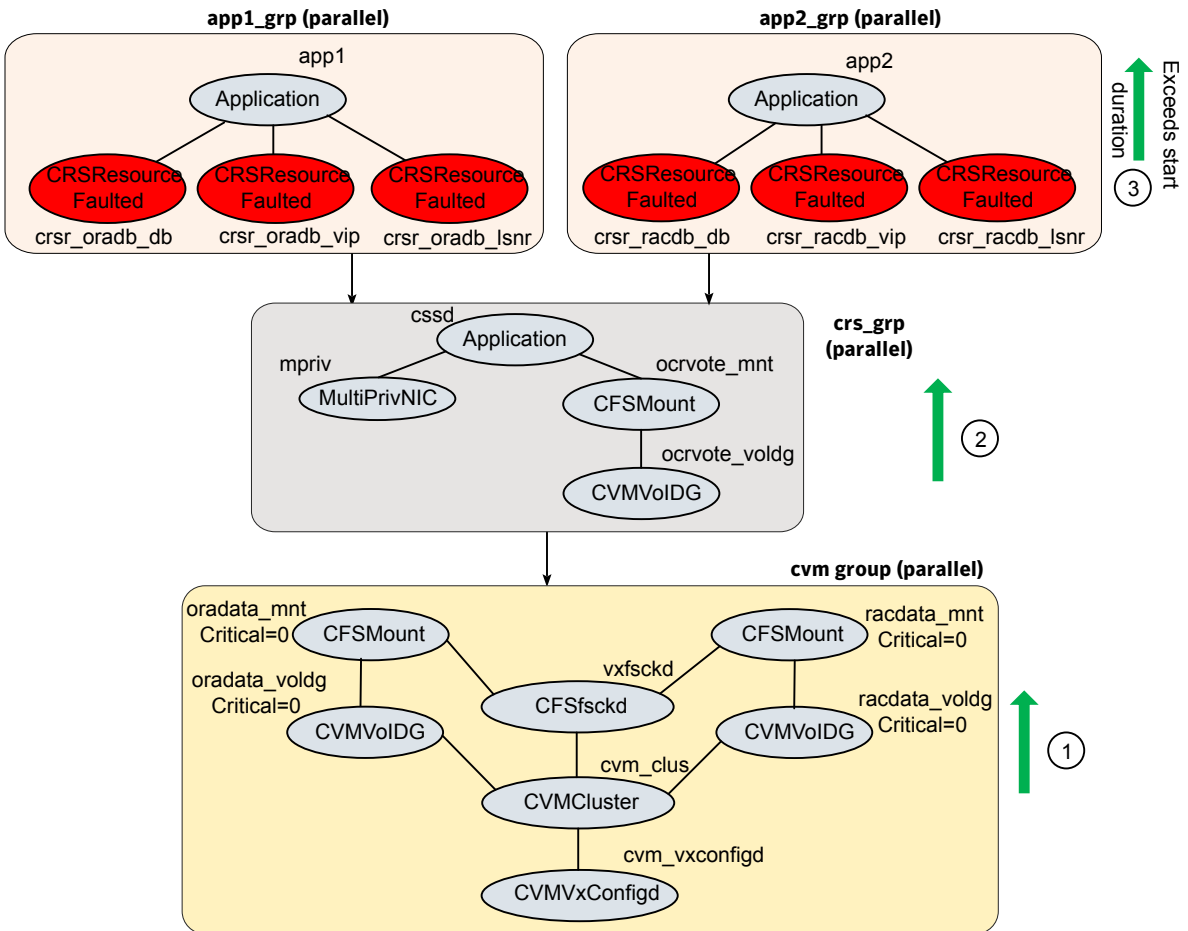

## Scenario 2: CRSResource fault when resource is brought offline

Any or all of the Oracle Clusterware resources (database, listener, or VIP) are brought offline due to a fault or for administrative purposes.

CRSResource reports FAULTED until Oracle Clusterware brings the resources online.

## Resource type definition for the CRSResource agent

The following extract from the `CRSResource.cf` file describes the type definition for the CRSResource agent.

```
type CRSResource (
 static int MonitorTimeout = 300
 static int OfflineMonitorInterval = 60
 static str ArgList[] = { ResType, DBHome, CRSHome,
 DBName, SID, Owner }
 static str Operations = None
 str ResType
 str DBHome
 str CRSHome
 str DBName
 str SID
 str Owner
)
```

## Sample configuration for the CRSResource agent

The following sample configuration describes the DB, VIP, and Listener resource configurations for the CRSResource agent.

```
CRSResource crsr_oradb_db (
 ResType = DB
 DBHome = "/app/oracle/orahome"
 CRSHome = "/app/crshome"
 DBName = oradb
 SID @sys1 = oradb1
 SID @sys2 = oradb2
 Owner = oracle
)

CRSResource crsr_oradb_vip (
 ResType = VIP
 DBHome = "/app/oracle/orahome"
 CRSHome = "/app/crshome"
```



```
)
CRSResource crsr_oradb_lsnr (
 ResType = Listener
 DBHome = "/app/oracle/orahome"
 CRSHome = "/app/crshome"
)
```

## SF Oracle RAC deployment scenarios

This appendix includes the following topics:

- SF Oracle RAC cluster with VCS IPC and PrivNIC agent
- SF Oracle RAC cluster with UDP IPC and PrivNIC agent
- SF Oracle RAC cluster for multiple databases with UDP IPC and MultiPrivNIC agent
- SF Oracle RAC cluster with isolated Oracle traffic and MultiPrivNIC agent
- SF Oracle RAC cluster with NIC bonding, VCS IPC and PrivNIC agent
- SF Oracle RAC cluster with NIC bonding, UDP IPC, and PrivNIC agent
- Configuration diagrams for setting up server-based I/O fencing
- Deploying Storage Foundation for Databases (SFDB) tools in a Storage Foundation for Oracle RAC environment

### SF Oracle RAC cluster with VCS IPC and PrivNIC agent

This section illustrates the recommended configuration for the following scenario:

|                                   |                                                                                                                             |
|-----------------------------------|-----------------------------------------------------------------------------------------------------------------------------|
| Deployment scenario               | Oracle RAC 10g database cache fusion traffic is distributed over multiple LLT links using VCS IPC over LMX/LLT.             |
| Recommendation                    | Use the PrivNIC agent.                                                                                                      |
| Sample main.cf configuration file | The following sample main.cf file describes the configuration:<br><code>/etc/VRTSvcs/conf/sample_rac/sfrac01_main.cf</code> |

In the illustrated configuration:

- Oracle uses VCS IPC over LMX/LLT for cache fusion.
- One private network IP address is used for Oracle Clusterware communication that takes place over one of the LLT private interconnect links.
- The CFS/CVM/VCS metadata and the Oracle database cache fusion traffic travels through LLT over the two physical links that are configured as LLT links.
- In the event of a NIC failure or link failure, the PrivNIC agent fails over the private network IP address from the failed link to the available LLT link. When the link is restored, the IP address is failed back to the original link.

[Figure I-1](#) illustrates the logical view of a two-node SF Oracle RAC cluster with VCS IPC and PrivNIC agent (Oracle RAC 10g).

**Figure I-1** SF Oracle RAC cluster with VCS IPC and PrivNIC agent (Oracle RAC 10g)

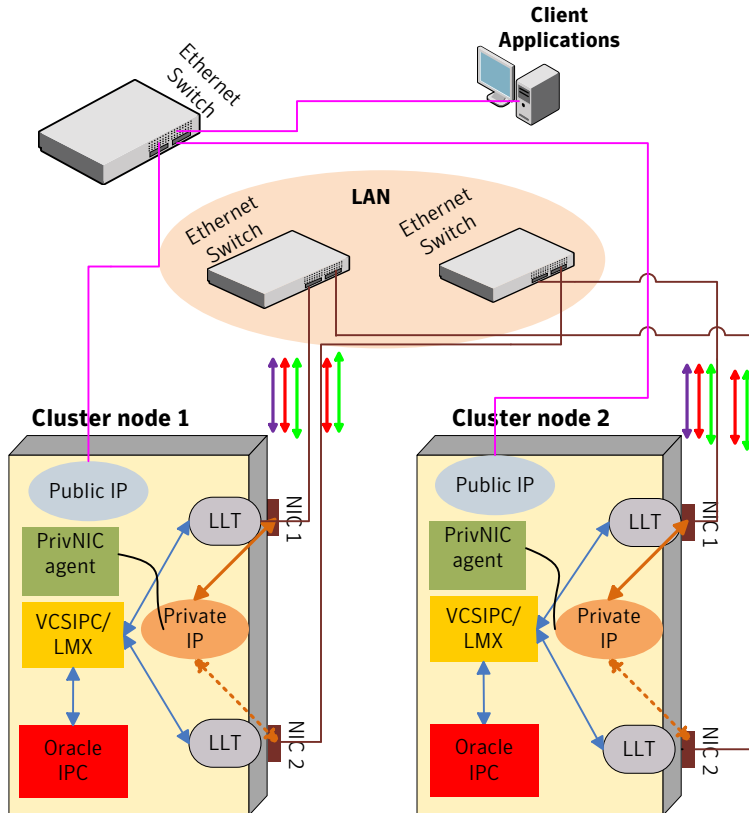

**Legends**

- |                              |  |                                    |  |
|------------------------------|--|------------------------------------|--|
| Public link (GigE)           |  | Oracle inter-process communication |  |
| Private Interconnect (GigE)  |  | Active connection                  |  |
| Oracle Clusterware Heartbeat |  | Failover connection for            |  |
| Oracle DB Cache Fusion       |  | PrivNIC Agent                      |  |
| CFS /CVM / VCS Metadata      |  |                                    |  |

# SF Oracle RAC cluster with UDP IPC and PrivNIC agent

This section illustrates the recommended configuration for the following scenario:

Deployment scenario      Oracle RAC configured with UDP IPC for database cache fusion.

Recommendation          Use the PrivNIC agent.

Sample main.cf  
configuration file          The following sample main.cf file describes the configuration:  
`/etc/VRTSvcs/conf/sample_rac/sfrac02_main.cf`

In the illustrated configuration:

- A common IP address is used for Oracle Clusterware communication and Oracle database cache fusion.
- Oracle Clusterware communication and Oracle database cache fusion traffic flows over one of the LLT private interconnect links.
- The CFS/CVM/VCS metadata travels through LLT over the two physical links that are configured as LLT links.
- In the event of a link failure, the PrivNIC agent fails over the private network IP address from the failed link to the available LLT link. When the link is restored, the IP address is failed back to the original link.

[Figure I-2](#) illustrates the logical view of a two-node SF Oracle RAC cluster with UDP IPC and PrivNIC agent.

Figure I-2 SF Oracle RAC cluster with UDP IPC and PrivNIC agent

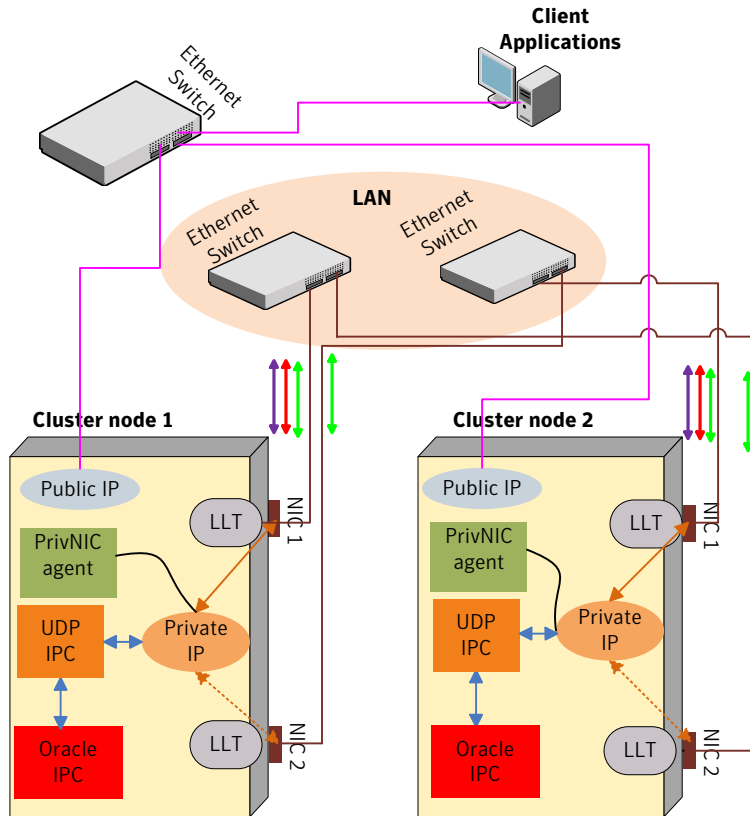

## SF Oracle RAC cluster for multiple databases with UDP IPC and MultiPrivNIC agent

This section illustrates the recommended configuration for the following scenario:

|                                   |                                                                                                                             |
|-----------------------------------|-----------------------------------------------------------------------------------------------------------------------------|
| Deployment scenario               | Oracle RAC is configured with UDP IPC for database cache fusion.                                                            |
| Recommendation                    | Use the MultiPrivNIC agent.                                                                                                 |
| Sample main.cf configuration file | The following sample main.cf file describes the configuration:<br><code>/etc/VRTSvcs/conf/sample_rac/sfrac03_main.cf</code> |

In the illustrated configuration:

- One private IP address is used for each database for database cache fusion. One of the private IP addresses used for the database cache fusion is shared by Oracle Clusterware communication. The CFS/CVM/VCS metadata also travels through these links.
- In the event of a link failure, the MultiPrivNIC agent fails over the private network IP address from the failed link to the available LLT link. When the link is restored, the IP address is failed back to the original link.

[Figure I-3](#) illustrates the logical view of a two-node SF Oracle RAC cluster for multiple databases with UDP IPC and MultiPrivNIC agent.

**Figure I-3** SF Oracle RAC cluster for multiple databases with UDP IPC and MultiPrivNIC agent

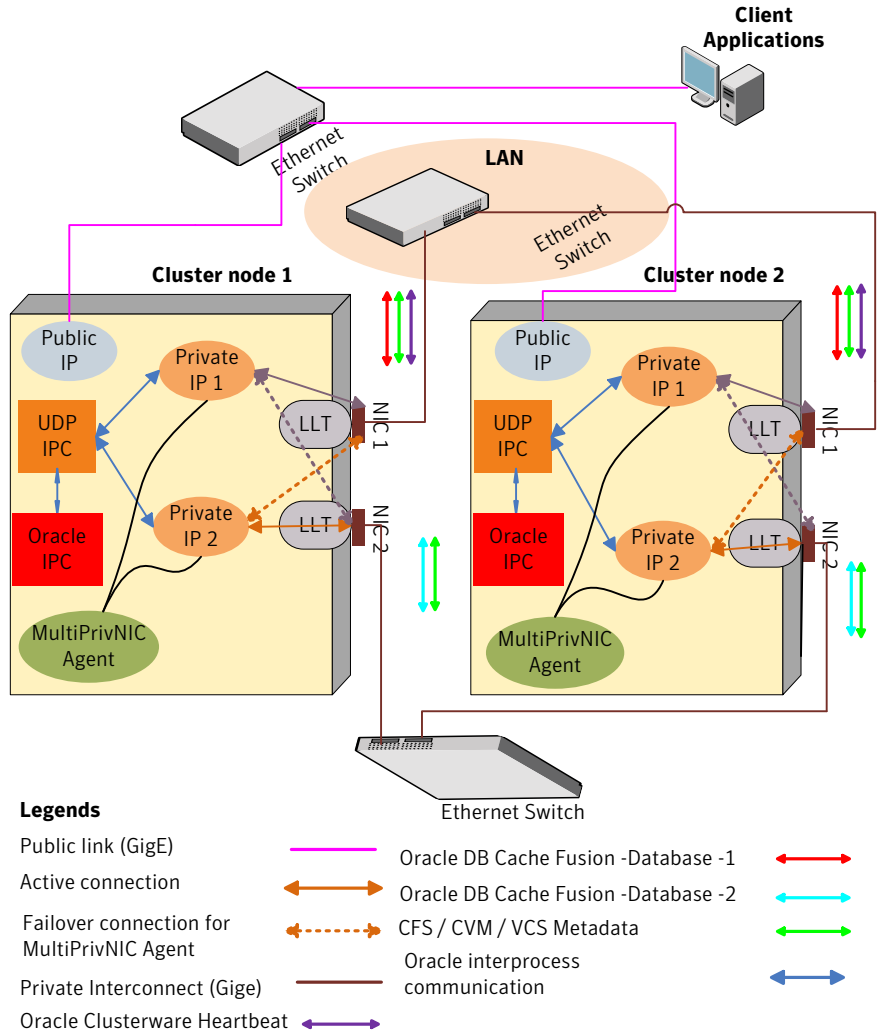



# SF Oracle RAC cluster with isolated Oracle traffic and MultiPrivNIC agent

This section illustrates the recommended configuration for the following scenario:

|                                   |                                                                                                                             |
|-----------------------------------|-----------------------------------------------------------------------------------------------------------------------------|
| Deployment scenario               | Oracle RAC database cache fusion traffic is isolated from the CFS/CVM/VCS metadata.                                         |
| Recommendation                    | Use the MultiPrivNIC agent.                                                                                                 |
| Sample main.cf configuration file | The following sample main.cf file describes the configuration:<br><code>/etc/VRTSvcs/conf/sample_rac/sfrac06_main.cf</code> |

In the illustrated configuration:

- The private network IP address used for database cache fusion is configured over a dedicated link for each database. These links are configured as low-priority LLT links.
- The private network IP address used for Oracle Clusterware communication is configured over a high-priority LLT link. This link is also used for the CFS/CVM/VCS metadata transfer.
- In the event of a link failure, the MultiPrivNIC agent fails over the private network IP address from the failed link to the available LLT link. When the link is restored, the IP address is failed back to the original link.

[Figure I-4](#) illustrates the logical view of a two-node SF Oracle RAC cluster with Oracle traffic isolated from VCS / CVM / CFS traffic.

**Figure I-4** SF Oracle RAC cluster with isolated Oracle traffic and MultiPrivNIC agent

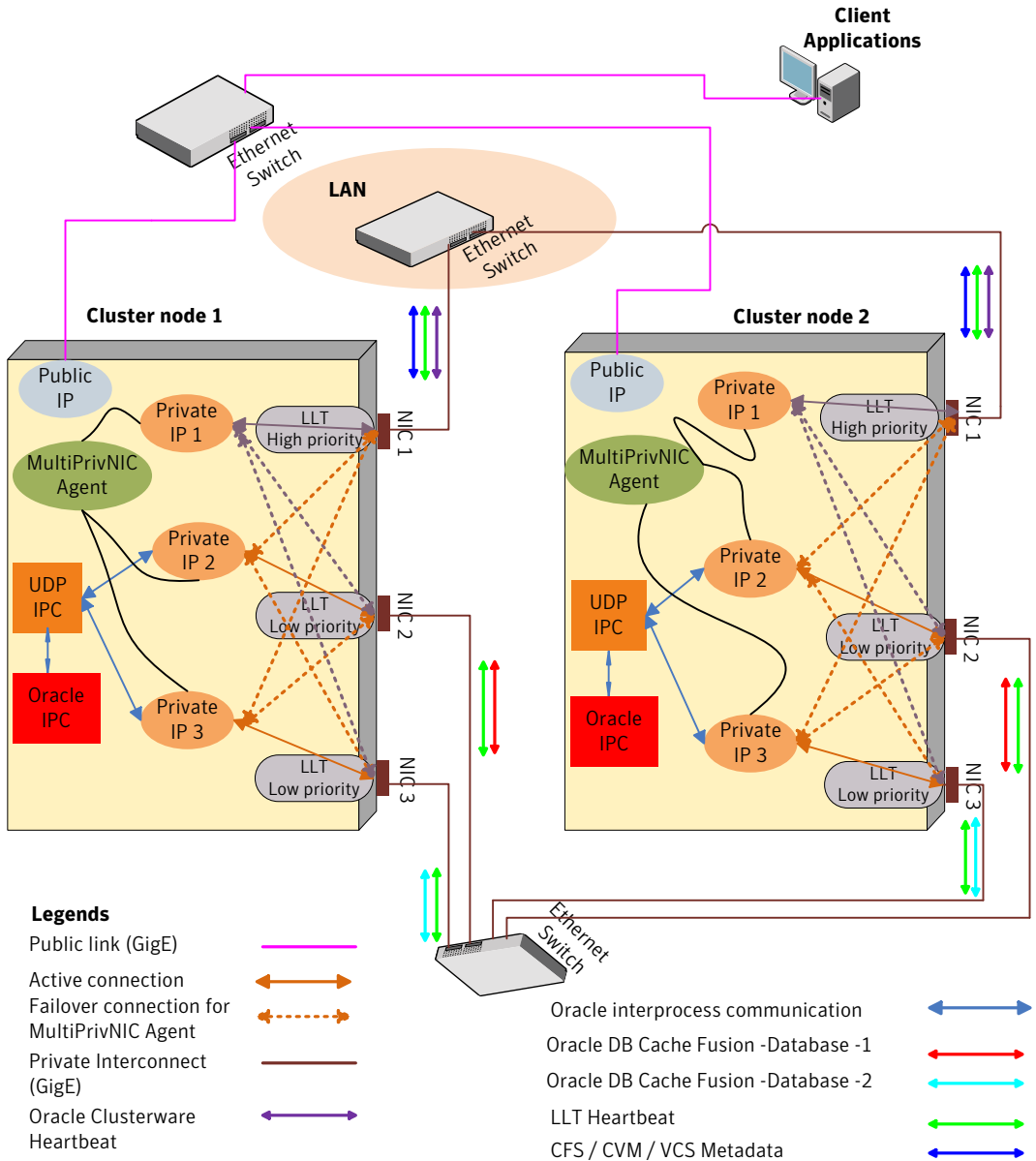

# SF Oracle RAC cluster with NIC bonding, VCS IPC and PrivNIC agent

This section illustrates the recommended configuration for the following scenario:

**Deployment scenario**     A bonded NIC interface is used along with another NIC interface to distribute Oracle RAC 10g database cache fusion traffic using VCS IPC over LMX/LLT.

**Recommendation**        Use the PrivNIC agent.

**Sample main.cf configuration file**     The following sample main.cf file describes the configuration:  
`/etc/VRTSvcs/conf/sample_rac/sfrac01_main.cf`

**Note:** You must replace the lan1 interface in the sample file with the bonded NIC interface you use in the scenario and lan2 in the sample file with the NIC3 interface in the scenario.

In the illustrated configuration:

- Oracle uses VCS IPC over LMX/LLT for cache fusion.
- One common private network IP address is used for Oracle database cache fusion and Oracle Clusterware communication that takes place over the bonded NIC interface, configured as an LLT link.
- The Oracle Clusterware communication takes place over the other LLT private interconnect link.
- The Oracle database cache fusion as well as the CFS/CVM/VCS metadata travels through LLT over the three physical links.
- In the event of a bonded NIC interface failure, the PrivNIC agent fails over the private network IP address from the failed link to the other available LLT link. When the link is restored, the IP address is failed back to the original link.

[Figure I-5](#) illustrates the logical view of a two-node SF Oracle RAC cluster with NIC bonding, VCS IPC, and PrivNIC agent (Oracle RAC 10g).

**Figure I-5** SF Oracle RAC cluster with NIC bonding, VCS IPC and PrivNIC agent (Oracle RAC 10g)

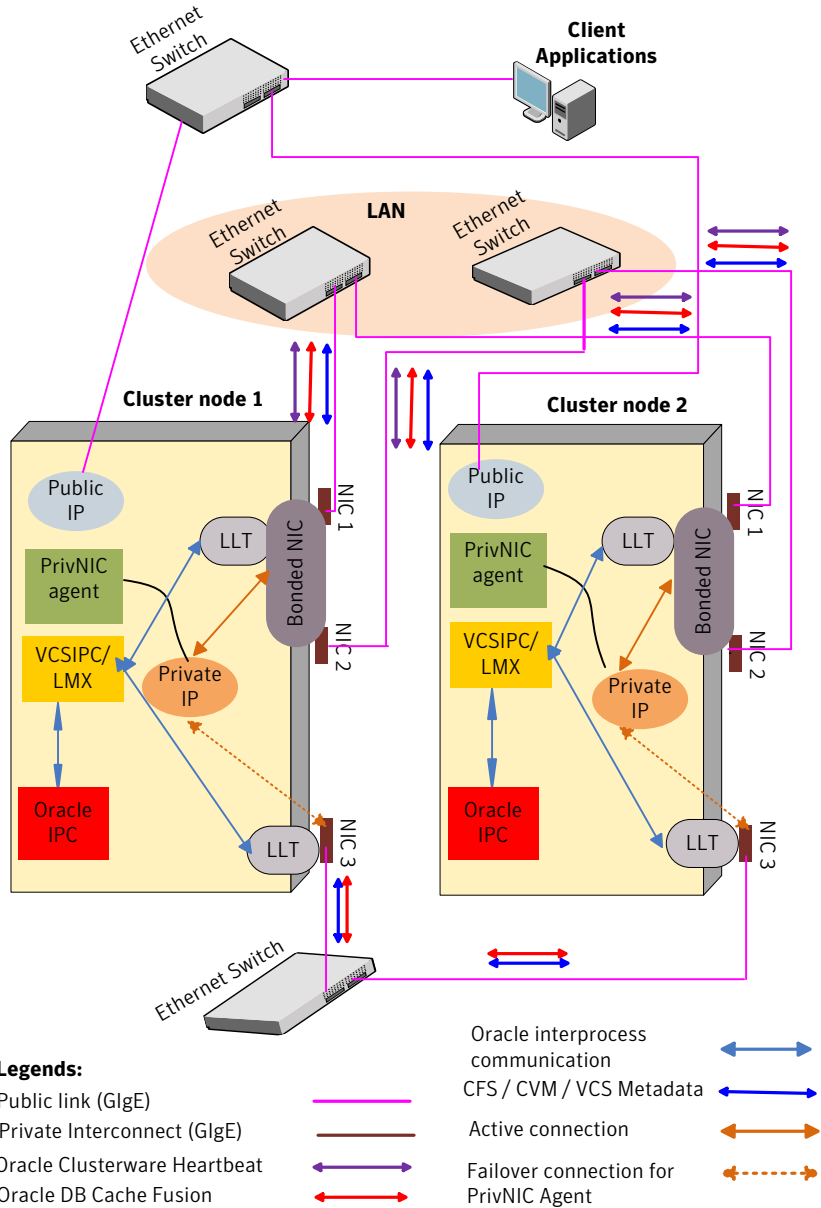

# SF Oracle RAC cluster with NIC bonding, UDP IPC, and PrivNIC agent

This section illustrates the recommended configuration for the following scenario:

|                                   |                                                                                                                                                                                                                                                                                                                                       |
|-----------------------------------|---------------------------------------------------------------------------------------------------------------------------------------------------------------------------------------------------------------------------------------------------------------------------------------------------------------------------------------|
| Deployment scenario               | Oracle RAC with UDP IPC is configured to use a bonded NIC interface for distribution of Oracle database cache fusion traffic.<br><br>A second link is configured as a standby link.                                                                                                                                                   |
| Recommendation                    | Use the PrivNIC agent.                                                                                                                                                                                                                                                                                                                |
| Sample main.cf configuration file | The following sample main.cf file describes the configuration:<br><br><code>/etc/VRTSvcs/conf/sample_rac/sfrac02_main.cf</code><br><br><b>Note:</b> You must replace the lan1 interface in the sample file with the bonded NIC interface you use in the scenario and lan2 in the sample file with the NIC3 interface in the scenario. |

In the illustrated configuration:

- A common IP address is used for Oracle Clusterware communication and Oracle database cache fusion that is distributed over two underlying physical links of the bonded NIC interface. The bonded NIC interface is configured as a single LLT link.
- The CFS/CVM/VCS metadata also travels through the bonded link.
- In the event of a bonded link failure, the PrivNIC agent fails over the private network IP address from the failed link to the available standby LLT link. When the link is restored, the IP address is failed back to the original link.

[Figure I-6](#) illustrates the logical view of a two-node SF Oracle RAC cluster with NIC bonding, UDP IPC, and PrivNIC agent.

Figure I-6 SF Oracle RAC cluster with NIC bonding, UDP IPC, and PrivNIC agent

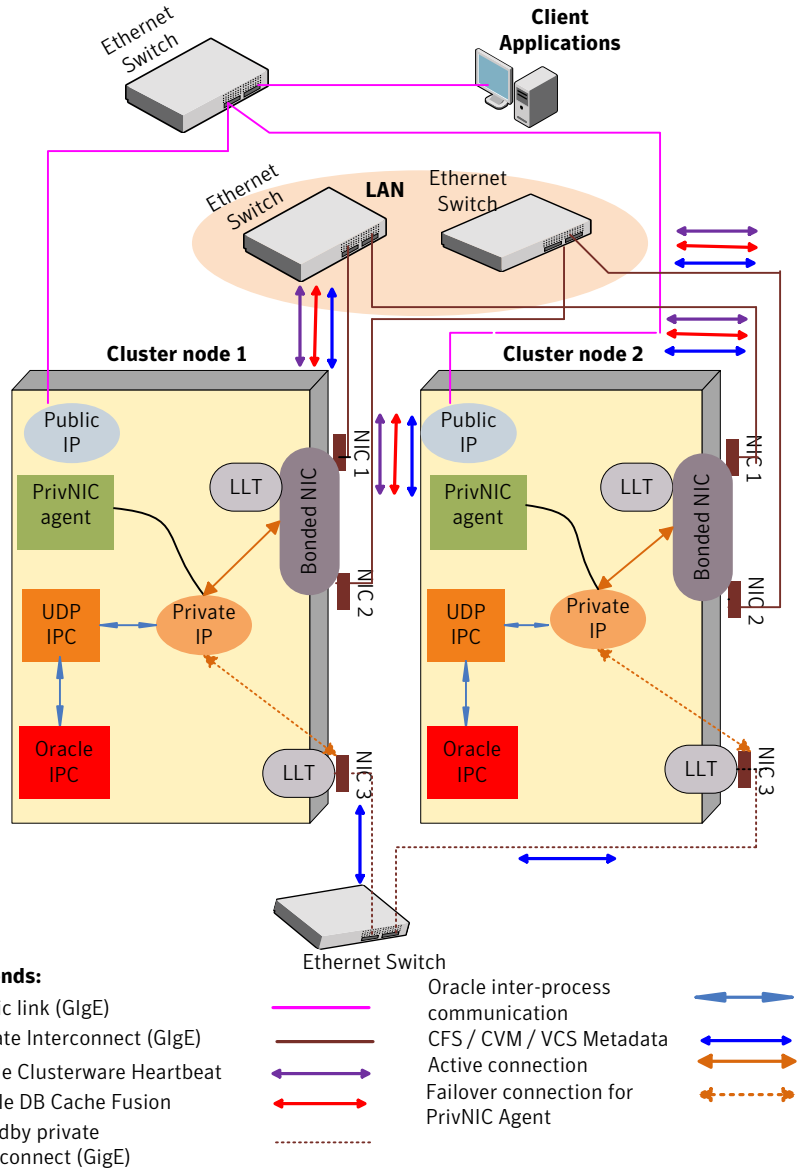

# Configuration diagrams for setting up server-based I/O fencing

The following CP server configuration diagrams can be used as guides when setting up CP server within your configuration:

- Two unique client clusters that are served by 3 CP servers:  
See [Figure I-7](#) on page 680.
- Client cluster that is served by highly available CP server and 2 SCSI-3 disks:
- Two node campus cluster that is served by remote CP server and 2 SCSI-3 disks:
- Multiple client clusters that are served by highly available CP server and 2 SCSI-3 disks:

## Two unique client clusters served by 3 CP servers

[Figure I-7](#) displays a configuration where two unique client clusters are being served by 3 CP servers (coordination points). Each client cluster has its own unique user ID (UUID1 and UUID2).

In the `vxfenmode` file on the client nodes, `vxfenmode` is set to `customized` with `vxfen` mechanism set to `cps`.

Figure I-7 Two unique client clusters served by 3 CP servers

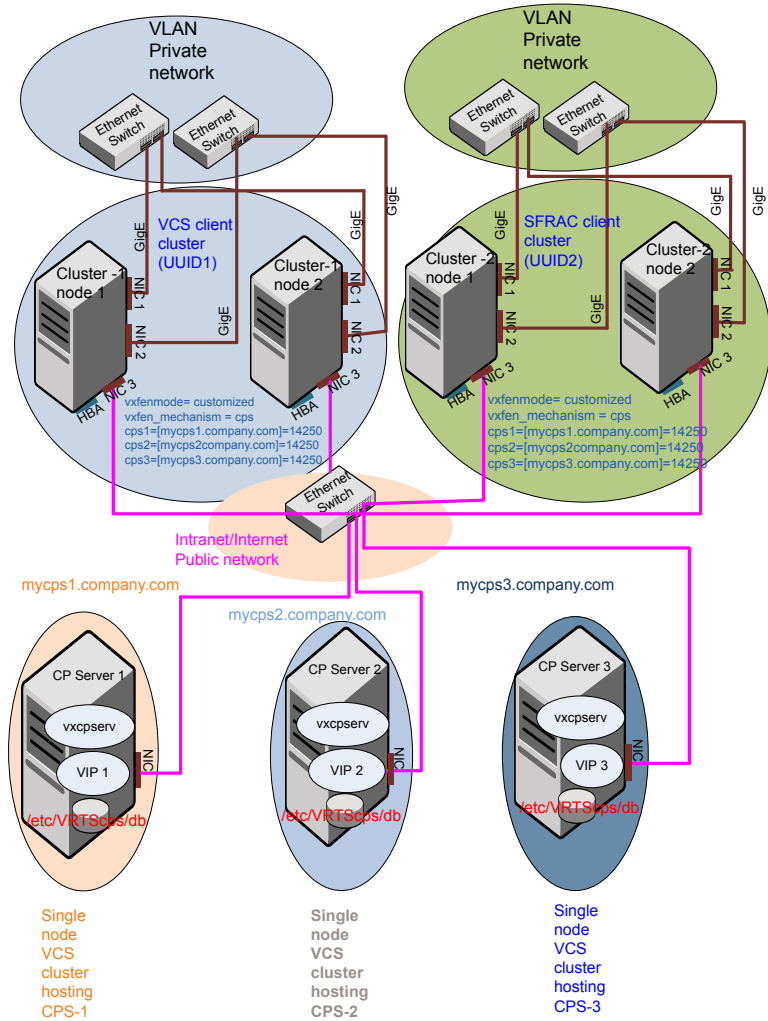

## Client cluster served by highly available CPS and 2 SCSI-3 disks

Figure I-8 displays a configuration where a client cluster is served by one highly available CP server and 2 local SCSI-3 LUNs (disks).

In the `vxfsnode` file on the client nodes, `vxfer_mechanism` is set to `vxfsnode` mechanism set to `cps`.



The two SCSI-3 disks are part of the disk group vxfscoorddg. The third coordination point is a CP server hosted on an SFHA cluster, with its own shared database and coordinator disks.

**Figure I-8** Client cluster served by highly available CP server and 2 SCSI-3 disks

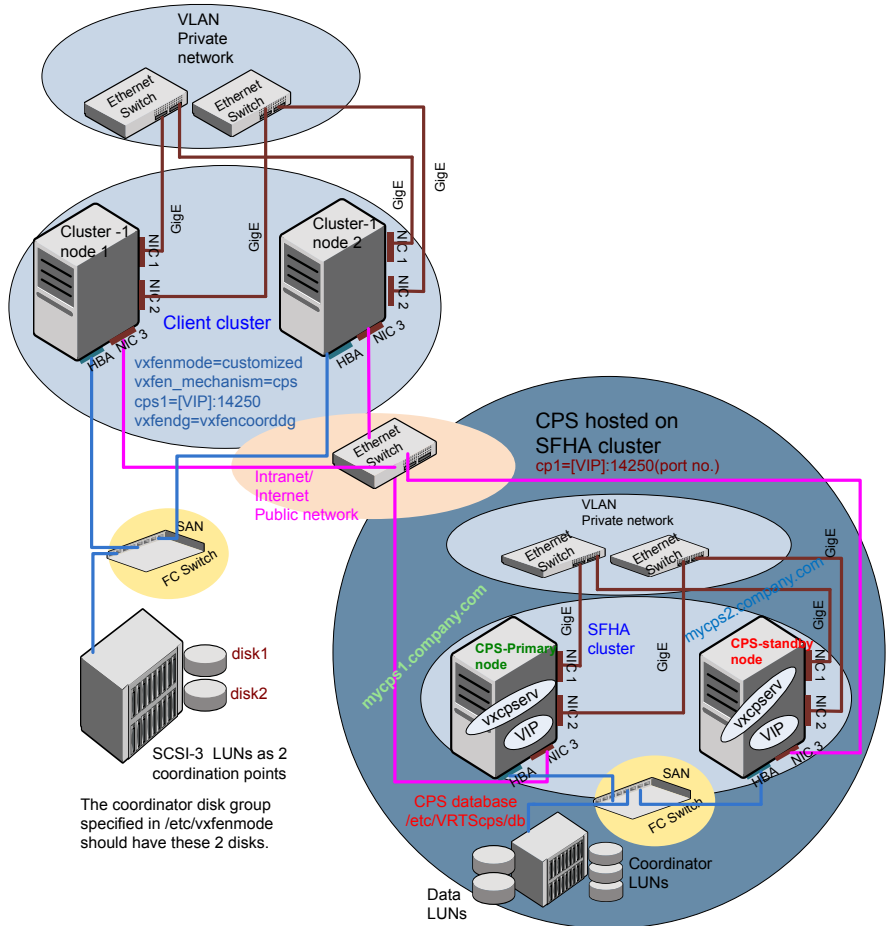

## Two node campus cluster served by remote CP server and 2 SCSI-3 disks

Figure I-9 displays a configuration where a two node campus cluster is being served by one remote CP server and 2 local SCSI-3 LUN (disks).

In the `vxfenmode` file on the client nodes, `vxfenmode` is set to `customized` with `vxfen` mechanism set to `cps`.

The two SCSI-3 disks (one from each site) are part of disk group `vxfencoorddg`. The third coordination point is a CP server on a single node VCS cluster.

Figure I-9 Two node campus cluster served by remote CP server and 2 SCSI-3

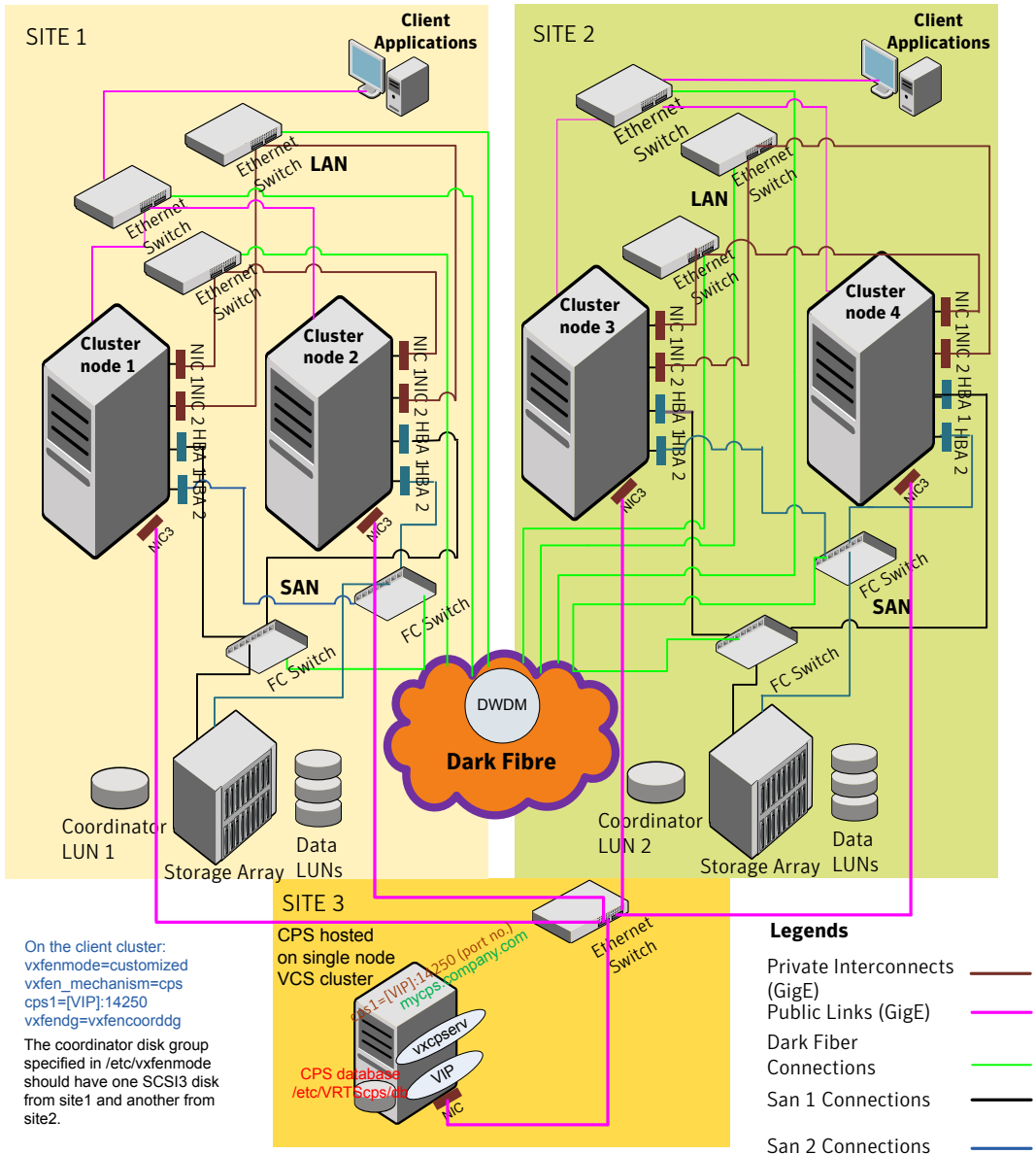

## Multiple client clusters served by highly available CP server and 2 SCSI-3 disks

Figure I-10 displays a configuration where multiple client clusters are being served by one highly available CP server and 2 local SCSI-3 LUNS (disks).

In the `vxfenmode` file on the client nodes, `vxfenmode` is set to `customized` with `vxfen` mechanism set to `cps`.

The two SCSI-3 disks are part of the disk group `vxfencoorddg`. The third coordination point is a CP server, hosted on an SFHA cluster, with its own shared database and coordinator disks.

**Figure I-10** Multiple client clusters served by highly available CP server and 2 SCSI-3 disks

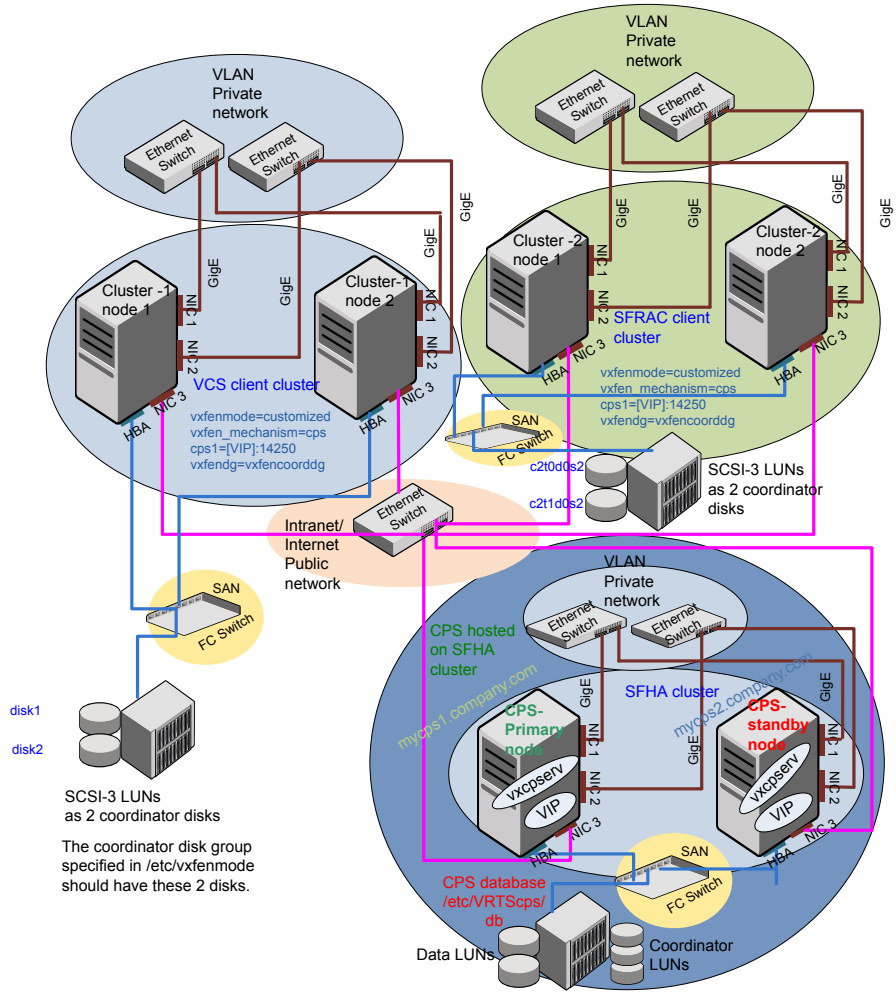

SCSI-3 LUNs as 2 coordinator disks  
 The coordinator disk group specified in `/etc/vxfsnode` should have these 2 disks.

## Deploying Storage Foundation for Databases (SFDB) tools in a Storage Foundation for Oracle RAC environment

If you are deploying the SFDB tools with Storage Foundation for Oracle RAC (multiple instance Oracle) your setup configuration will reflect the following conditions:

- A highly available parallel cluster with a multiple instances of Oracle is set up on sys1 and sys2 with SF for Oracle RAC.
- The database is online on sys1, sys2, and sys3.
- The datafiles are mounted and shared on sys1, sys2, and sys3.
- The SFDB tools is mounted and shared on sys1, sys2, and sys3.
- You can run the SFDB tools commands on sys1, sys2, and sys3.
- Clustered ODM is supported for this configuration.

In the figure below the repository directory resides in the Oracle mount points.

Figure I-11 Deploying the database repository with Storage Foundation

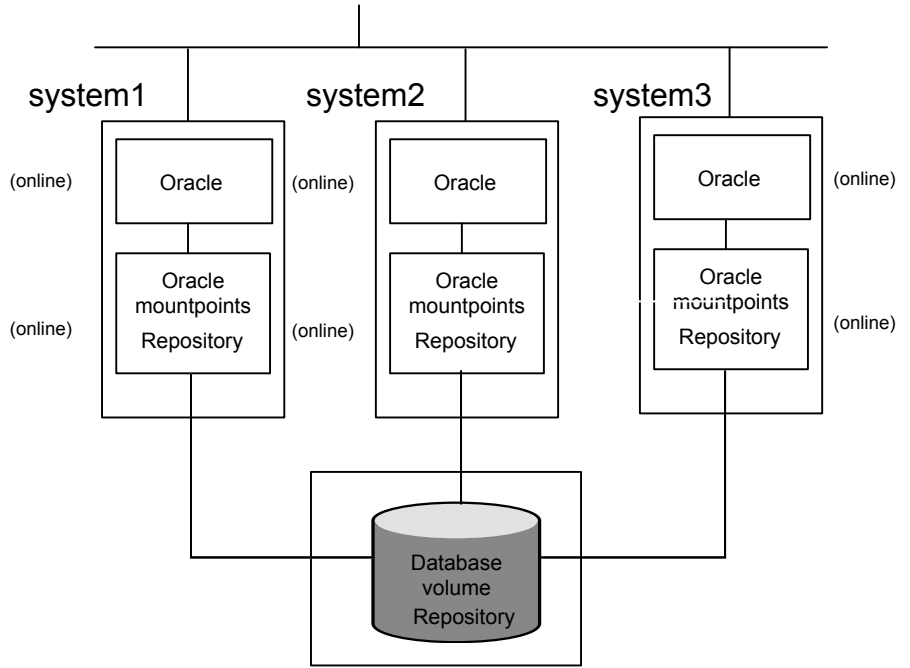

For an SF Oracle RAC configuration, the systems are online in parallel and do not use failover mechanisms within the cluster.

# Compatibility issues when installing Veritas Storage Foundation for Oracle RAC with other products

This appendix includes the following topics:

- [Installing, uninstalling, or upgrading Storage Foundation products when other Veritas products are present](#)
- [Installing, uninstalling, or upgrading Storage Foundation products when VOM is already present](#)
- [Installing, uninstalling, or upgrading Storage Foundation products when NetBackup is already present](#)

## Installing, uninstalling, or upgrading Storage Foundation products when other Veritas products are present

Installing Storage Foundation when other Veritas products are installed can create compatibility issues. For example, installing Storage Foundation products when VOM, ApplicationHA, and NetBackup are present on the systems.



## Installing, uninstalling, or upgrading Storage Foundation products when VOM is already present

If you plan to install or upgrade Storage Foundation products on systems where VOM has already been installed, be aware of the following compatibility issues:

- When you install or upgrade Storage Foundation products where SFM or VOM Central Server is present, the installer skips the VRTSsfmh upgrade and leaves the SFM Central Server and Managed Host depots as is.
- When uninstalling Storage Foundation products where SFM or VOM Central Server is present, the installer does not uninstall VRTSsfmh.
- When you install or upgrade Storage Foundation products where SFM or VOM Managed Host is present, the installer gives warning messages that it will upgrade VRTSsfmh.

## Installing, uninstalling, or upgrading Storage Foundation products when NetBackup is already present

If you plan to install or upgrade Storage Foundation on systems where NetBackup has already been installed, be aware of the following compatibility issues:

- When you install or upgrade Storage Foundation products where NetBackup is present, the installer does not uninstall VRTSspb and VRTSicsco. It does not upgrade VRTSat.
- When you uninstall Storage Foundation products where NetBackup is present, the installer does not uninstall VRTSspb, VRTSicsco, and VRTSat.

# Glossary

|                                     |                                                                                                                                                                                                                                                                                                                                                                                                                                                                                                                                                                                                                          |
|-------------------------------------|--------------------------------------------------------------------------------------------------------------------------------------------------------------------------------------------------------------------------------------------------------------------------------------------------------------------------------------------------------------------------------------------------------------------------------------------------------------------------------------------------------------------------------------------------------------------------------------------------------------------------|
| <b>Agent</b>                        | A process that starts, stops, and monitors all configured resources of a type, and reports their status to VCS.                                                                                                                                                                                                                                                                                                                                                                                                                                                                                                          |
| <b>Authentication Broker</b>        | The Veritas Security Services component that serves, one level beneath the root broker, as an intermediate registration authority and a certification authority. The authentication broker can authenticate clients, such as users or services, and grant them a certificate that will become part of the Veritas credential. An authentication broker cannot, however, authenticate other brokers. That task must be performed by the root broker.                                                                                                                                                                      |
| <b>Cluster</b>                      | A cluster is one or more computers that are linked together for the purpose of multiprocessing and high availability. The term is used synonymously with VCS cluster, meaning one or more computers that are part of the same GAB membership.                                                                                                                                                                                                                                                                                                                                                                            |
| <b>CVM (cluster volume manager)</b> | The cluster functionality of Veritas Volume Manager.                                                                                                                                                                                                                                                                                                                                                                                                                                                                                                                                                                     |
| <b>Disaster Recovery</b>            | Administrators with clusters in physically disparate areas can set the policy for migrating applications from one location to another if clusters in one geographic area become unavailable due to an unforeseen event. Disaster recovery requires heartbeating and replication.                                                                                                                                                                                                                                                                                                                                         |
| <b>disk array</b>                   | A collection of disks logically arranged into an object. Arrays tend to provide benefits such as redundancy or improved performance.                                                                                                                                                                                                                                                                                                                                                                                                                                                                                     |
| <b>DMP (Dynamic Multi-Pathing)</b>  | A feature designed to provide greater reliability and performance by using path failover and load balancing for multiported disk arrays connected to host systems through multiple paths. DMP detects the various paths to a disk using a mechanism that is specific to each supported array type. DMP can also differentiate between different enclosures of a supported array type that are connected to the same host system.                                                                                                                                                                                         |
| <b>SmartTier</b>                    | A feature with which administrators of multi-volume VxFS file systems can manage the placement of files on individual volumes in a volume set by defining placement policies that control both initial file location and the circumstances under which existing files are relocated. These placement policies cause the files to which they apply to be created and extended on specific subsets of a file system's volume set, known as placement classes. The files are relocated to volumes in other placement classes when they meet specified naming, timing, access rate, and storage capacity-related conditions. |

|                                     |                                                                                                                                                                                                                                                                                                                                                                                                                                                                                                                     |
|-------------------------------------|---------------------------------------------------------------------------------------------------------------------------------------------------------------------------------------------------------------------------------------------------------------------------------------------------------------------------------------------------------------------------------------------------------------------------------------------------------------------------------------------------------------------|
| <b>Failover</b>                     | A failover occurs when a service group faults and is migrated to another system.                                                                                                                                                                                                                                                                                                                                                                                                                                    |
| <b>GAB (Group Atomic Broadcast)</b> | A communication mechanism of the VCS engine that manages cluster membership, monitors heartbeat communication, and distributes information throughout the cluster.                                                                                                                                                                                                                                                                                                                                                  |
| <b>HA (high availability)</b>       | The concept of configuring the product to be highly available against system failure on a clustered network using Symantec Cluster Server (VCS).                                                                                                                                                                                                                                                                                                                                                                    |
| <b>IP address</b>                   | <p>An identifier for a computer or other device on a TCP/IP network, written as four eight-bit numbers separated by periods. Messages and other data are routed on the network according to their destination IP addresses.</p> <p>See also virtual IP address</p>                                                                                                                                                                                                                                                  |
| <b>Jeopardy</b>                     | A node is in jeopardy when it is missing one of the two required heartbeat connections. When a node is running with one heartbeat only (in jeopardy), VCS does not restart the applications on a new node. This action of disabling failover is a safety mechanism that prevents data corruption.                                                                                                                                                                                                                   |
| <b>latency</b>                      | For file systems, this typically refers to the amount of time it takes a given file system operation to return to the user.                                                                                                                                                                                                                                                                                                                                                                                         |
| <b>LLT (Low Latency Transport)</b>  | A communication mechanism of the VCS engine that provides kernel-to-kernel communications and monitors network communications.                                                                                                                                                                                                                                                                                                                                                                                      |
| <b>logical volume</b>               | <p>A simple volume that resides on an extended partition on a basic disk and is limited to the space within the extended partitions. A logical volume can be formatted and assigned a drive letter, and it can be subdivided into logical drives.</p> <p>See also LUN</p>                                                                                                                                                                                                                                           |
| <b>LUN</b>                          | A LUN, or logical unit, can either correspond to a single physical disk, or to a collection of disks that are exported as a single logical entity, or virtual disk, by a device driver or by an intelligent disk array's hardware. VxVM and other software modules may be capable of automatically discovering the special characteristics of LUNs, or you can use disk tags to define new storage attributes. Disk tags are administered by using the <code>vxdisk</code> command or the graphical user interface. |
| <b>main.cf</b>                      | The file in which the cluster configuration is stored.                                                                                                                                                                                                                                                                                                                                                                                                                                                              |
| <b>mirroring</b>                    | A form of storage redundancy in which two or more identical copies of data are maintained on separate volumes. (Each duplicate copy is known as a mirror.) Also RAID Level 1.                                                                                                                                                                                                                                                                                                                                       |
| <b>Node</b>                         | The physical host or system on which applications and service groups reside. When systems are linked by VCS, they become nodes in a cluster.                                                                                                                                                                                                                                                                                                                                                                        |
| <b>resources</b>                    | Individual components that work together to provide application services to the public network. A resource may be a physical component such as a disk group or                                                                                                                                                                                                                                                                                                                                                      |

|                                   |                                                                                                                                                                                                                                                                                                                                                                        |
|-----------------------------------|------------------------------------------------------------------------------------------------------------------------------------------------------------------------------------------------------------------------------------------------------------------------------------------------------------------------------------------------------------------------|
|                                   | network interface card, a software component such as a database server or a Web server, or a configuration component such as an IP address or mounted file system.                                                                                                                                                                                                     |
| <b>Resource Dependency</b>        | A dependency between resources is indicated by the keyword "requires" between two resource names. This indicates the second resource (the child) must be online before the first resource (the parent) can be brought online. Conversely, the parent must be offline before the child can be taken offline. Also, faults of the children are propagated to the parent. |
| <b>Resource Types</b>             | Each resource in a cluster is identified by a unique name and classified according to its type. VCS includes a set of pre-defined resource types for storage, networking, and application services.                                                                                                                                                                    |
| <b>root broker</b>                | The first authentication broker, which has a self-signed certificate. The root broker has a single private domain that holds only the names of brokers that shall be considered valid.                                                                                                                                                                                 |
| <b>SAN (storage area network)</b> | A networking paradigm that provides easily reconfigurable connectivity between any subset of computers, disk storage and interconnecting hardware such as switches, hubs and bridges.                                                                                                                                                                                  |
| <b>Service Group</b>              | A service group is a collection of resources working together to provide application services to clients. It typically includes multiple resources, hardware- and software-based, working together to provide a single service.                                                                                                                                        |
| <b>Service Group Dependency</b>   | A service group dependency provides a mechanism by which two service groups can be linked by a dependency rule, similar to the way resources are linked.                                                                                                                                                                                                               |
| <b>Shared Storage</b>             | Storage devices that are connected to and used by two or more systems.                                                                                                                                                                                                                                                                                                 |
| <b>shared volume</b>              | A volume that belongs to a shared disk group and is open on more than one node at the same time.                                                                                                                                                                                                                                                                       |
| <b>SNMP Notification</b>          | Simple Network Management Protocol (SNMP) developed to manage nodes on an IP network.                                                                                                                                                                                                                                                                                  |
| <b>State</b>                      | The current activity status of a resource, group or system. Resource states are given relative to both systems.                                                                                                                                                                                                                                                        |
| <b>Storage Checkpoint</b>         | A facility that provides a consistent and stable view of a file system or database image and keeps track of modified data blocks since the last Storage Checkpoint.                                                                                                                                                                                                    |
| <b>System</b>                     | The physical system on which applications and service groups reside. When a system is linked by VCS, it becomes a node in a cluster.<br><br>See Node                                                                                                                                                                                                                   |
| <b>types.cf</b>                   | A file that describes standard resource types to the VCS engine; specifically, the data required to control a specific resource.                                                                                                                                                                                                                                       |

|                                        |                                                                                                                                                                                                                                                                                                                            |
|----------------------------------------|----------------------------------------------------------------------------------------------------------------------------------------------------------------------------------------------------------------------------------------------------------------------------------------------------------------------------|
| <b>VCS (Symantec Cluster Server)</b>   | An open systems clustering solution designed to eliminate planned and unplanned downtime, simplify server consolidation, and allow the effective management of a wide range of applications in multiplatform environments.                                                                                                 |
| <b>Virtual IP Address</b>              | A unique IP address associated with the cluster. It may be brought up on any system in the cluster, along with the other resources of the service group. This address, also known as the IP alias, should not be confused with the base IP address, which is the IP address that corresponds to the host name of a system. |
| <b>VxFS (Veritas File System)</b>      | A component of the Symantec Storage Foundation product suite that provides high performance and online management capabilities to facilitate the creation and maintenance of file systems. A file system is a collection of directories organized into a structure that enables you to locate and store files.             |
| <b>VxVM (Veritas Volume Manager)</b>   | A Symantec product installed on storage clients that enables management of physical disks as logical devices. It enhances data storage management by controlling space allocation, performance, data availability, device installation, and system monitoring of private and shared systems.                               |
| <b>VVR (Veritas Volume Replicator)</b> | A data replication tool designed to contribute to an effective disaster recovery plan.                                                                                                                                                                                                                                     |

# Index

## Symbols

- \$CRS\_HOME
  - setting up 289
- \$ORACLE\_HOME
  - setting up 289

## A

- adding
  - users 98
- agent operations
  - Netlsnr agent 649
  - Oracle agent 635
- agents
  - about 602
  - CFSfsckd 616
  - CFSMount 612, 616
  - CSSD 631
  - CVMCluster 604
  - CVMVolDg 609
  - CVMVxconfigd 606
  - log files 344
  - MultiPrivNIC 625
  - of VCS 603
  - of VCS for Oracle 603
  - PrivNIC 619
- ASM
  - about 585
  - configuring with CVM
    - about 588
    - configuring disk group 592
    - creating shared raw volumes 593
    - installing ASM 589
  - main.cf 597
  - SF Oracle RAC configuration 586
  - unlinking ODM 591
  - verifying setup 594
- ASMDG agent
  - attribute definitions 655
  - resource type 655
- ASMDG agent attributes
  - AgentDirectory 655

## ASMDG agent attributes *(continued)*

- DBAPword 655
- DBAUser 655
- DiskGroups 655
- Encoding 655
- EnvFile 655
- Home 655
- Owner 655
- Sid 655
- attribute definitions
  - ASMDG agent 655
  - Netlsnr agent 650
  - Oracle agent 642
- attributes
  - about agent attributes 603
  - CFSMount agent 613, 617
  - CVMCluster agent 605
  - CVMVolDg agent 605, 610
  - CVMVxconfigd agent 607
  - MultiPrivNIC agent 627
  - PrivNIC agent
    - optional 622
    - required 620
- Automatic Storage Management. *See* ASM

## B

- basic monitoring 637
  - health check 637
  - process 637

## C

- cables
  - cross-over Ethernet 416
- CFS
  - creating databases 600
  - stopping applications 487
  - unmounting file systems 488
- CFSfsckd agent 616
  - attributes 617
- CFSMount agent 612, 616
  - attributes 613

CFSSMount agent (*continued*)  
   entry points 613  
   sample configuration 615–616  
   type definition 615  
 CFSTypes.cf 615  
 cluster  
   removing a node from 463  
   verifying operation 148  
 cluster configuration 87  
 Cluster File System. *See* CFS  
 Cluster Manager 30  
 Cluster Volume Manager. *See* CVM  
 clusters  
   basic setup 32  
   four-node illustration 33  
 commands  
   hastatus 148  
   hasys 149  
   lltconfig 553  
   lltstat 144  
   vxassist 600  
   vxdisksetup (initializing disks) 105  
   vxdedit 600  
   vxvol 600  
 configuration  
   required information  
     for CVM 528  
     for global clusters 529  
     for I/O fencing 527  
     for VCS 526  
     for VVR 530  
 configuration files  
   removing 494  
     *See also* main.cf samples  
 configuring  
   rsh 582  
   ssh 582–583  
 Configuring global clusters  
   tasks 477  
 configuring VCS  
   adding users 98  
   event notification 99, 101  
   global clusters 103  
 creating SD bundle 138  
 CSSD agent 631  
   attributes 633  
 CVM  
   configuration worksheet 543  
   CVMTypes.cf file 606

CVM (*continued*)  
   installation worksheet 543–544  
   required information  
     for configuration 528  
   upgrading protocol version 233  
 CVMCluster agent 604  
   attributes 605  
   entry points 604  
   sample configuration 606  
   type definition 606  
 CVMTypes.cf  
   definition, CVMCluster agent 606  
   definition, CVMVolDg agent 611  
   definition, CVMVxconfigd agent 609  
 CVMVolDg agent 609  
   attributes 610  
   entry points 609  
   sample configuration 612  
   type definition 611  
 CVMVxconfigd agent 606  
   attributes 607  
   CVMTypes.cf 609  
   entry points 607  
   sample configuration 609  
   type definition 609

## D

databases  
   creating 598  
   creating tablespaces  
     on CFS 600  
     on raw volumes 599  
 dbca  
   description 598  
 detail monitoring 637  
 disks  
   adding and initializing 105  
   testing with vxfcntlshdw 106  
   verifying node access 109

## E

environment variables  
   MANPATH 74  
 Ethernet controllers 416

## F

files. *See* configuration files

**G**

- GAB
  - port memberships 146
- GAB ports 147
- gabtab file
  - verifying after installation 553
- Global Cluster Option (GCO)
  - overview 38
- global clusters
  - about 29
  - configuration 103
  - overview 477
  - required information
    - for configuration 529

**H**

- hastatus -summary command 148
- hasys -display command 149
- health check APIs 637
- health check monitoring 637
- hubs
  - independent 416

**I**

- I/O fencing
  - checking disks 106
  - required information
    - for configuration 527
  - shared storage 106
- Ignite
  - installing 138
- Ignite-UX 141
  - installing standalone 139
- installation
  - of Oracle Clusterware 302, 305
  - of Oracle Grid Infrastructure 302, 305
  - of Oracle RAC 241
  - preparation 522
- installation worksheets 522
- installing
  - Ignite 138
  - Ignite-UX 139, 141
  - standalone 139
- installsrac
  - installing Clusterware 302, 305
  - installing Oracle Grid Infrastructure 302, 305
  - installing Oracle RAC 245
  - installing SF Oracle RAC 82

- installsrac (*continued*)
  - upgrading SF Oracle RAC 168

**J**

- Java Console 30

**L**

- links
  - private network 553
- LLT
  - interconnects 75
  - verifying 144
- lltconfig command 553
- llthosts file
  - verifying after installation 553
- lltstat command 144
- llttab file
  - verifying after installation 553

**M**

- main.cf
  - after SF Oracle RAC installation 552
- main.cf files 575
- main.cf samples
  - for CSSD resource 634
- MANPATH environment variable 74
- media speed 75
  - optimizing 75
- migration, of Oracle 346
- monitoring
  - basic 637
  - detail 637
- MultiPrivNIC
  - for UDP 284
- MultiPrivNIC agent 625
  - attributes 627
  - entry point 626
  - type definition 630
- MultiPrivNIC.cf 630
  - sample configuration 631

**N**

- Netlsnr agent
  - attribute definitions 650
  - operations 649
  - resource type 650
- Netlsnr agent attributes
  - AgentDebug 650



Netsnr agent attributes *(continued)*

- AgentDirectory 650
- EnvFile 650
- Home 650
- Listener 650
- LsnrPwd 650
- MonScript 650
- Owner 650
- TnsAdmin 650

## nodes

- adding Oracle RAC nodes
  - configuring GAB 423
  - configuring LLT 423
  - configuring VCSMM 423
  - configuring VXFEN 423
  - starting Volume Manager 423
- preparing Oracle RAC nodes
  - configuring CVM 432
  - configuring private IP addresses 452
  - preparing \$CRS\_HOME 454
  - preparing \$ORACLE\_HOME 454
- removing a node from a cluster 463
  - tasks 462
- removing nodes
  - GAB configuration 465
  - LLT configuration 465
  - modifying VCS configuration 466

**O**

## OCR

- creating
  - on raw volumes 263
- creating file system
  - using CLI 264

## operations

- Netsnr agent 649
- Oracle agent 635

## optimizing

- media speed 75

## Oracle

- agent log file 344
- creating databases 599–600
- stopping instances 485
- supported versions 47

## Oracle 11g

- migration from Oracle RAC 10g 349
- post-upgrade tasks 350

## Oracle 11g Release 2

- migration from Oracle RAC 10g
  - of existing database 350
  - pre-upgrade tasks 347

## Oracle 11gRelease 2

- migration from Oracle 9i 2
  - pre-upgrade tasks 348

## Oracle agent

- attribute definitions 642
- operations 635
- resource type 641

## Oracle agent attributes

- AgentDebug 642
- AgentDirectory 642
- AutoEndBkup 642
- DBAPword 642
- DBAUser 642
- EnvFile 642
- Home 642
- IMF 642
- MonitorOption 642
- MonScript 642
- Owner 642
- Pfile 642
- Pword 642
- ShutDownOpt 642
- Sid 642
- StartUpOpt 642
- Table 642
- User 642

## Oracle Grid Infrastructure

- installing 302, 305

## Oracle RAC

- installation
  - installing database 311, 313
  - workflow 299
- manual installation
  - installing database binaries 316
  - installing Oracle Clusterware 308
  - installing Oracle Grid Infrastructure 308
- post-installation
  - adding UDP IP addresses 332
- pre-installation
  - creating OCR 263
  - creating Oracle disk groups 252
  - creating Oracle users and groups 247
  - creating voting disk volumes 263
  - identifying public virtual IP addresses 244
  - setting system parameters 244–245

- Oracle RAC (*continued*)
  - pre-installation (*continued*)
    - setting up Oracle user equivalence 298
    - setting up storage 53
    - starting installsrac 245
    - workflow 241
- Oracle RAC 11g
  - agent log file 344
  - configuring service groups
    - preventing automatic starting of database 344
  - installation
    - configuring service groups 334
    - setting environment variables 302, 305
    - verifying 317
  - post-installation
    - adding patches 320
    - creating database 331
    - relinking SF Oracle RAC libraries 327
  - pre-installation
    - configuring MultiPrivNIC 284
    - preparing \$CRS\_HOME 289
    - preparing \$ORACLE\_HOME 289
    - setting environment variables 302, 305
- Oracle RAC 11g Clusterware
  - verifying installation 317
- Oracle RAC 11g Release 1 Clusterware
  - creating file system 457

## P

- patches
  - adding 320
- patchsets
  - adding 320
- PATH variable
  - VCS commands 144
- ports
  - GAB 147
- PrivNIC agent 619
  - attributes 620
  - entry point 620
  - sample configuration 625
  - type definition 624
- PrivNIC.cf 624
- process monitoring 637

## R

- raw volumes
  - creating
    - Oracle DBCA procedure 593
- removing a node from a cluster
  - editing VCS configuration files 465
  - procedure 463
  - tasks 462
- resource type
  - ASMDG 655
  - Netlsnr 650
  - Oracle 641
- response file
  - about 353
  - syntax 355
- rolling upgrade 199
  - versions 193
- rsh 583
  - configuration 582

## S

- SD bundle 138
- secure clusters
  - adding users 528
- service groups
  - configuring 334
- setting umask, before installing 73
- SF Oracle RAC
  - about 25
  - high-level view 32
- SF Oracle RAC configuration
  - configuring clusters 87
  - creating configuration files 104
  - of components 85
  - preparation
    - worksheets 522
  - starting processes 104
- SF Oracle RAC installation
  - pre-installation tasks
    - mounting product disc 73
    - setting MANPATH 74
    - setting umask 73
    - setting up shared storage 74
    - synchronizing time settings 73
    - verifying systems 75
  - preinstallation information 40
  - preparation
    - worksheets 522

- SF Oracle RAC installation *(continued)*
  - requirements
    - hardware 41
    - software 47
  - using `installsfrac` 82
  - verifying
    - cluster operations 144
    - GAB operations 144
    - LLT operations 144
- SF Oracle RAC uninstallation
  - preparation
    - stopping applications, CFS 487
    - stopping applications, VxFS 489
    - stopping Oracle instances 485
    - stopping VCS 488
    - uninstalling 487
    - unmounting CFS file systems 488
    - unmounting VxFS file systems 489
  - removing configuration files 494
  - removing depots 492
  - using `uninstallsfrac` 492
  - workflow 482
- SF Oracle RAC upgrade
  - post-upgrade tasks
    - relinking Oracle RAC libraries 229
    - upgrading CVM protocol version 233
    - upgrading disk group version 233
  - preparation 161, 196
  - restoring configuration files 169
  - stopping cluster resources 161, 196
  - stopping Oracle RAC 161, 196
  - upgrading licenses 206
  - using `installsfrac` 168
- SFDB authentication 154
  - adding nodes 459
  - configuring `vxdbd` 154
- shared storage
  - setting up 74
- SMTP email notification 99
- SNMP trap notification 101
- ssh 583
  - configuration 582
  - configuring 583
- Storage Foundation for Oracle RAC configuration
  - verifying 146
- synchronizing time settings, before installing 73
- system communication using `rsh`
  - ssh 583
- system state attribute value 148

## T

- tunables file
  - about setting parameters 510
  - parameter definitions 515
  - preparing 514
  - setting for configuration 511
  - setting for installation 511
  - setting for upgrade 511
  - setting parameters 514
  - setting with no other operations 512
  - setting with un-integrated response file 513

## U

- uninstallation
  - of SF Oracle RAC 491
- `uninstallsfrac`
  - removing depots 492
- upgrading
  - rolling 199
- users
  - creating 247
  - for `&ProductNameShort;`, adding 528

## V

- VCS
  - agent log file 344
  - command directory path variable 144
  - notifications 29
  - required information
    - for configuration 526
  - stopping 488
- VCS notifications
  - SMTP notification 29
  - SNMP notification 29
- Veritas File System
  - stopping applications 489
  - unmounting 489
- Veritas Operations Manager 30
- virtual fire drill 640
- voting disk
  - creating
    - on raw volumes 263
- voting disks
  - creating file system
    - using CLI 264
- VVR
  - about 30
  - configuration worksheet 543

**VVR** (*continued*)

- global cluster overview 478
- installation worksheet 543–544
- required information
  - for configuration 530
- vxassist command 600
- vxdisksetup command 105
- VxFS. *See* Veritas File System
- vxvol command 600

**W**

## worksheets

- for &ProductNameShort; 523
- for CVM 543
- for replication
  - SRDF 544
  - VVR 543
- for VVR 543