

Cluster Server 7.1 Administrator's Guide - AIX

Last updated: 2016-12-04

Document version: 7.1 Rev 0

Legal Notice

Copyright © 2016 Veritas Technologies LLC. All rights reserved.

Veritas, the Veritas Logo, Veritas InfoScale, and NetBackup are trademarks or registered trademarks of Veritas Technologies LLC or its affiliates in the U.S. and other countries. Other names may be trademarks of their respective owners.

This product may contain third party software for which Veritas is required to provide attribution to the third party ("Third Party Programs"). Some of the Third Party Programs are available under open source or free software licenses. The License Agreement accompanying the Software does not alter any rights or obligations you may have under those open source or free software licenses. Refer to the third party legal notices document accompanying this Veritas product or available at:

<https://www.veritas.com/about/legal/license-agreements>

The product described in this document is distributed under licenses restricting its use, copying, distribution, and decompilation/reverse engineering. No part of this document may be reproduced in any form by any means without prior written authorization of Veritas Technologies LLC and its licensors, if any.

THE DOCUMENTATION IS PROVIDED "AS IS" AND ALL EXPRESS OR IMPLIED CONDITIONS, REPRESENTATIONS AND WARRANTIES, INCLUDING ANY IMPLIED WARRANTY OF MERCHANTABILITY, FITNESS FOR A PARTICULAR PURPOSE OR NON-INFRINGEMENT, ARE DISCLAIMED, EXCEPT TO THE EXTENT THAT SUCH DISCLAIMERS ARE HELD TO BE LEGALLY INVALID. VERITAS TECHNOLOGIES LLC SHALL NOT BE LIABLE FOR INCIDENTAL OR CONSEQUENTIAL DAMAGES IN CONNECTION WITH THE FURNISHING, PERFORMANCE, OR USE OF THIS DOCUMENTATION. THE INFORMATION CONTAINED IN THIS DOCUMENTATION IS SUBJECT TO CHANGE WITHOUT NOTICE.

The Licensed Software and Documentation are deemed to be commercial computer software as defined in FAR 12.212 and subject to restricted rights as defined in FAR Section 52.227-19 "Commercial Computer Software - Restricted Rights" and DFARS 227.7202, et seq. "Commercial Computer Software and Commercial Computer Software Documentation," as applicable, and any successor regulations, whether delivered by Veritas as on premises or hosted services. Any use, modification, reproduction release, performance, display or disclosure of the Licensed Software and Documentation by the U.S. Government shall be solely in accordance with the terms of this Agreement.

Veritas Technologies LLC
500 E Middlefield Road
Mountain View, CA 94043

<http://www.veritas.com>

Technical Support

Technical Support maintains support centers globally. All support services will be delivered in accordance with your support agreement and the then-current enterprise technical support policies. For information about our support offerings and how to contact Technical Support, visit our website:

<https://www.veritas.com/support>

You can manage your Veritas account information at the following URL:

<https://my.veritas.com>

If you have questions regarding an existing support agreement, please email the support agreement administration team for your region as follows:

Worldwide (except Japan)

CustomerCare@veritas.com

Japan

CustomerCare_Japan@veritas.com

Documentation

Make sure that you have the current version of the documentation. Each document displays the date of the last update on page 2. The document version appears on page 2 of each guide. The latest documentation is available on the Veritas website:

<https://sort.veritas.com/documents>

Documentation feedback

Your feedback is important to us. Suggest improvements or report errors or omissions to the documentation. Include the document title, document version, chapter title, and section title of the text on which you are reporting. Send feedback to:

doc.feedback@veritas.com

You can also see documentation information or ask a question on the Veritas community site:

<http://www.veritas.com/community/>

Veritas Services and Operations Readiness Tools (SORT)

Veritas Services and Operations Readiness Tools (SORT) is a website that provides information and tools to automate and simplify certain time-consuming administrative tasks. Depending on the product, SORT helps you prepare for installations and upgrades, identify risks in your datacenters, and improve operational efficiency. To see what services and tools SORT provides for your product, see the data sheet:

https://sort.veritas.com/data/support/SORT_Data_Sheet.pdf

Contents

Section 1	Clustering concepts and terminology	26
Chapter 1	Introducing Cluster Server	27
	About Cluster Server	27
	How VCS detects failure	27
	How VCS ensures application availability	28
	About cluster control guidelines	29
	Defined start, stop, and monitor procedures	29
	Ability to restart the application in a known state	30
	External data storage	30
	Licensing and host name issues	31
	About the physical components of VCS	31
	About VCS nodes	31
	About shared storage	32
	About networking	32
	Logical components of VCS	32
	About resources and resource dependencies	33
	Categories of resources	35
	About resource types	35
	About service groups	36
	Types of service groups	36
	About the ClusterService group	37
	About the cluster UUID	37
	About agents in VCS	38
	About agent functions	39
	About resource monitoring	40
	Agent classifications	43
	VCS agent framework	44
	About cluster control, communications, and membership	44
	About security services	47
	Components for administering VCS	48
	Putting the pieces together	50

Chapter 2	About cluster topologies	52
	Basic failover configurations	52
	Asymmetric or active / passive configuration	52
	Symmetric or active / active configuration	53
	About N-to-1 configuration	54
	About advanced failover configurations	55
	About the N + 1 configuration	55
	About the N-to-N configuration	56
	Cluster topologies and storage configurations	57
	About basic shared storage cluster	57
	About campus, or metropolitan, shared storage cluster	58
	About shared nothing clusters	59
	About replicated data clusters	59
	About global clusters	60
Chapter 3	VCS configuration concepts	62
	About configuring VCS	62
	VCS configuration language	63
	About the main.cf file	63
	About the SystemList attribute	66
	Initial configuration	66
	Including multiple .cf files in main.cf	67
	About the types.cf file	67
	About VCS attributes	69
	About attribute data types	69
	About attribute dimensions	70
	About attributes and cluster objects	70
	Attribute scope across systems: global and local attributes	72
	About attribute life: temporary attributes	72
	Size limitations for VCS objects	72
	VCS keywords and reserved words	73
	VCS environment variables	73
	Defining VCS environment variables	77
	Environment variables to start and stop VCS modules	78

Section 2	Administration - Putting VCS to work	81
Chapter 4	About the VCS user privilege model	82
	About VCS user privileges and roles	82
	VCS privilege levels	82
	User roles in VCS	83
	Hierarchy in VCS roles	84
	User privileges for CLI commands	84
	User privileges for cross-cluster operations	85
	User privileges for clusters that run in secure mode	85
	About the cluster-level user	86
	How administrators assign roles to users	86
	User privileges for OS user groups for clusters running in secure mode	87
	VCS privileges for users with multiple roles	88
Chapter 5	Administering the cluster from Cluster Manager (Java console)	90
	About the Cluster Manager (Java Console)	91
	About disability compliance	91
	Getting started prerequisites	92
	Setting the display on UNIX systems	93
	Using Java Console with secure shell	93
	Starting Cluster Manager (Java console)	94
	Components of the Java Console	95
	Icons in the Java Console	95
	About Cluster Monitor	97
	Cluster monitor toolbar	97
	About cluster monitor panels	98
	Status of the cluster connection with Cluster Monitor	99
	Monitoring VCS objects with Cluster Monitor	99
	Expanding and collapsing the Cluster Monitor display	100
	Customizing the Cluster Manager display	100
	About Cluster Explorer	102
	Cluster Explorer toolbar	103
	Cluster Explorer configuration tree	105
	Cluster Explorer view panel	105
	Status view	106
	Properties view	107

Service Group view	109
Resource view	110
Moving and linking icons in Service Group and Resource views	111
Zooming in on Service Group and Resource views	111
System Connectivity view	112
Remote Cluster Status view	113
Accessing additional features of the Java Console	114
Template view	114
System Manager	115
User Manager	115
Command Center	116
Configuration wizard	116
Notifier Resource Configuration wizard	117
Remote Group Resource Configuration Wizard	117
Cluster query	117
Logs	118
Server and user credentials	119
Administering Cluster Monitor	120
Configuring a new cluster panel	120
Modifying a cluster panel configuration	121
Logging on to a cluster and logging off	121
Administering user profiles	123
Adding a user	124
Deleting a user	124
Changing a user password	125
Changing a user privilege	126
Assigning privileges for OS user groups for clusters running in secure mode	126
Administering service groups	127
Adding a service group	127
Deleting a service group	130
Bringing a service group online	131
Taking a service group offline	132
Switching a service group	133
Freezing a service group	134
Unfreezing a service group	135
Enabling a service group	135
Disabling a service group	136
Autoenabling a service group	136
Flushing a service group	137
Linking service groups	138
Unlinking service groups	139

Managing systems for a service group	140
Creating service groups with the configuration wizard	141
Administering resources	144
Adding a resource	144
Adding a RemoteGroup resource from the Java Console	146
Deleting a resource	149
Bringing a resource online	149
Taking a resource offline	149
Taking a resource offline and propagating the command	150
Probing a resource	151
Overriding resource type static attributes	151
Enabling resources in a service group	152
Disabling resources in a service group	153
Clearing a resource	153
Linking resources	154
Unlinking resources	155
Invoking a resource action	157
Refreshing the ResourceInfo attribute	157
Clearing the ResourceInfo attribute	157
Importing resource types	158
Running HA fire drill from the Java Console	158
Administering systems	159
Adding a system	159
Deleting a system	160
Freezing a system	160
Unfreezing a system	161
Administering clusters	161
Opening a cluster configuration	161
Saving a cluster configuration	161
Saving and closing a cluster configuration	162
Running commands	162
Editing attributes	163
Querying the cluster configuration	164
Setting up VCS event notification by using the Notifier wizard	165
Administering logs	168
Customizing the log display	169
Resetting the log display	170
Monitoring alerts	170
Administering VCS Simulator	172

Chapter 6	Administering the cluster from the command line	173
	About administering VCS from the command line	174
	Symbols used in the VCS command syntax	174
	How VCS identifies the local system	175
	About specifying values preceded by a dash (-)	175
	About the -modify option	175
	Encrypting VCS passwords	176
	Encrypting agent passwords	176
	Encrypting agent passwords by using security keys	177
	About installing a VCS license	179
	Installing and updating license keys using vxlicinst	180
	Setting or changing the product level for keyless licensing	180
	Administering LLT	181
	Displaying the cluster details and LLT version for LLT links	182
	Adding and removing LLT links	182
	Configuring aggregated interfaces under LLT	184
	Configuring destination-based load balancing for LLT	186
	Administering the AMF kernel driver	186
	Starting VCS	188
	Starting the VCS engine (HAD) and related processes	189
	Stopping VCS	189
	Stopping the VCS engine and related processes	191
	About stopping VCS without the -force option	191
	About stopping VCS with options other than the -force option	192
	About controlling the hastop behavior by using the EngineShutdown attribute	192
	Additional considerations for stopping VCS	193
	Logging on to VCS	193
	Running high availability commands (HA) commands as non-root users on clusters in secure mode	195
	About managing VCS configuration files	195
	About multiple versions of .cf files	195
	Verifying a configuration	195
	Scheduling automatic backups for VCS configuration files	196
	Saving a configuration	196
	Setting the configuration to read or write	197
	Displaying configuration files in the correct format	197
	About managing VCS users from the command line	197
	Adding a user	198
	Assigning and removing user privileges	199

Modifying a user	200
Deleting a user	200
Displaying a user	201
About querying VCS	201
Querying service groups	202
Querying resources	203
Querying resource types	204
Querying agents	205
Querying systems	206
Querying clusters	206
Querying status	207
Querying log data files (LDFs)	208
Using conditional statements to query VCS objects	209
About administering service groups	210
Adding and deleting service groups	210
Modifying service group attributes	211
Bringing service groups online	213
Taking service groups offline	214
Switching service groups	214
Migrating service groups	215
Freezing and unfreezing service groups	216
Enabling and disabling service groups	216
Enabling and disabling priority based failover for a service group	217
Clearing faulted resources in a service group	218
Flushing service groups	219
Linking and unlinking service groups	220
Administering agents	221
About administering resources	222
About adding resources	222
Adding resources	222
Deleting resources	223
Adding, deleting, and modifying resource attributes	223
Defining attributes as local	225
Defining attributes as global	227
Enabling and disabling intelligent resource monitoring for agents manually	227
Enabling and disabling IMF for agents by using script	229
Linking and unlinking resources	234
Bringing resources online	235
Taking resources offline	236
Probing a resource	236
Clearing a resource	237

About administering resource types	237
Adding, deleting, and modifying resource types	237
Overriding resource type static attributes	238
About initializing resource type scheduling and priority attributes	239
Setting scheduling and priority attributes	239
Administering systems	240
About administering clusters	242
Configuring and unconfiguring the cluster UUID value	242
Retrieving version information	244
Adding and removing systems	244
Changing ports for VCS	245
Setting cluster attributes from the command line	247
About initializing cluster attributes in the configuration file	248
Enabling and disabling secure mode for the cluster	248
Migrating from secure mode to secure mode with FIPS	250
Using the -wait option in scripts that use VCS commands	250
Running HA fire drills	251
About administering simulated clusters from the command line	252

Chapter 7

Configuring applications and resources in VCS

.....	253
Configuring resources and applications	253
VCS bundled agents for UNIX	254
About Storage agents	254
About Network agents	255
About File share agents	257
About Services and Application agents	258
About VCS infrastructure and support agents	259
About Testing agents	260
Configuring NFS service groups	261
About NFS	261
Configuring NFS service groups	262
Sample configurations	270
About configuring the RemoteGroup agent	291
About the ControlMode attribute	291
About the ReturnIntOffline attribute	293
Configuring a RemoteGroup resource	293
Service group behavior with the RemoteGroup agent	294
About configuring Samba service groups	296
Sample configuration for Samba in a failover configuration	296
Configuring the Coordination Point agent	298

	About migration of data from LVM volumes to VxVM volumes	298
	About testing resource failover by using HA fire drills	298
	About HA fire drills	299
	About running an HA fire drill	299
Chapter 8	Predicting VCS behavior using VCS Simulator	
	300
	About VCS Simulator	300
	VCS Simulator ports	301
	Administering VCS Simulator from the command line interface	302
	Starting VCS Simulator from the command line interface	303
	Administering simulated clusters from the command line	305
Section 3	VCS communication and operations	307
Chapter 9	About communications, membership, and data protection in the cluster	308
	About cluster communications	308
	About intra-system communications	309
	About inter-system cluster communications	309
	About cluster membership	313
	Initial joining of systems to cluster membership	313
	Ongoing cluster membership	316
	About membership arbitration	317
	About membership arbitration components	317
	About server-based I/O fencing	325
	About majority-based fencing	328
	About making CP server highly available	329
	About the CP server database	330
	Recommended CP server configurations	330
	About the CP server service group	333
	About the CP server user types and privileges	335
	About secure communication between the VCS cluster and CP server	335
	About data protection	337
	About SCSI-3 Persistent Reservation	337
	About I/O fencing configuration files	338
	Examples of VCS operation with I/O fencing	340
	About the I/O fencing algorithm	341
	Example: Two-system cluster where one system fails	341

Example: Four-system cluster where cluster interconnect fails	342
How I/O fencing works in different event scenarios	345
About cluster membership and data protection without I/O fencing	349
About jeopardy	350
About Daemon Down Node Alive (DDNA)	350
Examples of VCS operation without I/O fencing	351
Example: Four-system cluster without a low priority link	351
Example: Four-system cluster with low priority link	353
Summary of best practices for cluster communications	356

Chapter 10	Administering I/O fencing	358
	About administering I/O fencing	358
	About the vxfstshdw utility	359
	General guidelines for using the vxfstshdw utility	359
	About the vxfstshdw command options	360
	Testing the coordinator disk group using the -c option of vxfstshdw	362
	Performing non-destructive testing on the disks using the -r option	364
	Testing the shared disks using the vxfstshdw -m option	364
	Testing the shared disks listed in a file using the vxfstshdw -f option	366
	Testing all the disks in a disk group using the vxfstshdw -g option	366
	Testing a disk with existing keys	367
	Testing disks with the vxfstshdw -o option	367
	About the vxfenadm utility	368
	About the I/O fencing registration key format	368
	Displaying the I/O fencing registration keys	369
	Verifying that the nodes see the same disk	372
	About the vxfenclearpre utility	373
	Removing preexisting keys	374
	About the vxfenswap utility	376
	Replacing I/O fencing coordinator disks when the cluster is online	377
	Replacing the coordinator disk group in a cluster that is online	380
	Adding disks from a recovered site to the coordinator disk group	385
	Refreshing lost keys on coordinator disks	387

About administering the coordination point server	388
CP server operations (cpsadm)	388
Cloning a CP server	389
Adding and removing VCS cluster entries from the CP server database	391
Adding and removing a VCS cluster node from the CP server database	392
Adding or removing CP server users	392
Listing the CP server users	393
Listing the nodes in all the VCS clusters	393
Listing the membership of nodes in the VCS cluster	393
Preempting a node	393
Registering and unregistering a node	394
Enable and disable access for a user to a VCS cluster	394
Starting and stopping CP server outside VCS control	395
Checking the connectivity of CP servers	395
Adding and removing virtual IP addresses and ports for CP servers at run-time	395
Taking a CP server database snapshot	398
Replacing coordination points for server-based fencing in an online cluster	398
Refreshing registration keys on the coordination points for server-based fencing	400
Deployment and migration scenarios for CP server	402
About migrating between disk-based and server-based fencing configurations	408
Migrating from disk-based to server-based fencing in an online cluster	408
Migrating from server-based to disk-based fencing in an online cluster	409
Migrating between fencing configurations using response files	409
Enabling or disabling the preferred fencing policy	415
About I/O fencing log files	417
Chapter 11 Controlling VCS behavior	418
VCS behavior on resource faults	418
Critical and non-critical resources	419
VCS behavior diagrams	419
About controlling VCS behavior at the service group level	421
About the AutoRestart attribute	421
About controlling failover on service group or system faults	422

About defining failover policies	423
About AdaptiveHA	424
About system zones	428
About sites	428
Load-based autostart	429
About freezing service groups	429
About controlling Clean behavior on resource faults	429
Clearing resources in the ADMIN_WAIT state	430
About controlling fault propagation	432
Customized behavior diagrams	432
About preventing concurrency violation	433
VCS behavior for resources that support the intentional offline functionality	437
VCS behavior when a service group is restarted	438
About controlling VCS behavior at the resource level	439
Resource type attributes that control resource behavior	439
How VCS handles resource faults	441
VCS behavior after a resource is declared faulted	445
VCS behavior when a resource is restarted	447
About disabling resources	448
Changing agent file paths and binaries	451
VCS behavior on loss of storage connectivity	452
Disk group configuration and VCS behavior	452
How VCS attributes control behavior on loss of storage connectivity	453
VCS behavior when a disk group is disabled	454
Recommendations to ensure application availability	455
Service group workload management	455
About enabling service group workload management	455
System capacity and service group load	455
System limits and service group prerequisites	457
About capacity and limits	457
Sample configurations depicting workload management	458
System and Service group definitions	458
Sample configuration: Basic four-node cluster	459
Sample configuration: Complex four-node cluster	463
Sample configuration: Server consolidation	467
Chapter 12 The role of service group dependencies	475
About service group dependencies	475
About dependency links	475
About dependency limitations	479

	Service group dependency configurations	479
	About failover parent / failover child	479
	Frequently asked questions about group dependencies	493
	About linking service groups	495
	About linking multiple child service groups	495
	Dependencies supported for multiple child service groups	495
	Dependencies not supported for multiple child service groups ...	
	4	9
	6	
	VCS behavior with service group dependencies	496
	Online operations in group dependencies	496
	Offline operations in group dependencies	497
	Switch operations in group dependencies	497
Section 4	Administration - Beyond the basics	498
Chapter 13	VCS event notification	499
	About VCS event notification	499
	Event messages and severity levels	501
	About persistent and replicated message queue	501
	How HAD deletes messages	501
	Components of VCS event notification	502
	About the notifier process	502
	About the hanotify utility	503
	About VCS events and traps	504
	Events and traps for clusters	504
	Events and traps for agents	505
	Events and traps for resources	505
	Events and traps for systems	507
	Events and traps for service groups	508
	SNMP-specific files	509
	Trap variables in VCS MIB	510
	About monitoring aggregate events	513
	How to detect service group failover	513
	How to detect service group switch	513
	About configuring notification	513
Chapter 14	VCS event triggers	515
	About VCS event triggers	515
	Using event triggers	516
	Performing multiple actions using a trigger	516
	List of event triggers	517

	About the dumptunables trigger	517
	About the globalcounter_not_updated trigger	517
	About the injeopardy event trigger	518
	About the loadwarning event trigger	518
	About the multinicb event trigger	519
	About the nofailover event trigger	520
	About the postoffline event trigger	520
	About the postonline event trigger	521
	About the preonline event trigger	521
	About the resadminwait event trigger	522
	About the resfault event trigger	523
	About the resnotoff event trigger	524
	About the resrestart event trigger	524
	About the resstatechange event trigger	525
	About the sysoffline event trigger	526
	About the sysup trigger	527
	About the sysjoin trigger	527
	About the unable_to_restart_agent event trigger	527
	About the unable_to_restart_had event trigger	528
	About the violation event trigger	528
Chapter 15	Virtual Business Services	529
	About Virtual Business Services	529
	Features of Virtual Business Services	529
	Sample virtual business service configuration	530
	About choosing between VCS and VBS level dependencies	532
Section 5	Veritas High Availability Configuration wizard	533
Chapter 16	Introducing the Veritas High Availability Configuration wizard	534
	About the Veritas High Availability Configuration wizard	534
	Launching the Veritas High Availability Configuration wizard	535
	Typical VCS cluster configuration in a physical environment	537

Chapter 17	Administering application monitoring from the Veritas High Availability view	539
	Administering application monitoring from the Veritas High Availability view	539
	view	539
	Understanding the Veritas High Availability view	540
	To view the status of configured applications	543
	To configure or unconfigure application monitoring	543
	To start or stop applications	545
	To suspend or resume application monitoring	546
	To switch an application to another system	547
	To add or remove a failover system	548
	To clear Fault state	551
	To resolve a held-up operation	551
	To determine application state	552
	To remove all monitoring configurations	552
	To remove VCS cluster configurations	552
	Administering application monitoring settings	553
Section 6	Cluster configurations for disaster recovery	555
Chapter 18	Connecting clusters—Creating global clusters	556
	5 5 6	
	How VCS global clusters work	556
	VCS global clusters: The building blocks	557
	Visualization of remote cluster objects	558
	About global service groups	558
	About global cluster management	559
	About serialization—The Authority attribute	560
	About resiliency and "Right of way"	561
	VCS agents to manage wide-area failover	561
	About the Steward process: Split-brain in two-cluster global clusters	564
	Secure communication in global clusters	565
	Prerequisites for global clusters	565
	Prerequisites for cluster setup	566
	Prerequisites for application setup	566
	Prerequisites for wide-area heartbeats	567
	Prerequisites for ClusterService group	567
	Prerequisites for replication setup	567

Prerequisites for clusters running in secure mode	568
About planning to set up global clusters	568
Setting up a global cluster	569
Configuring application and replication for global cluster setup	570
Configuring clusters for global cluster setup	571
Configuring service groups for global cluster setup	578
Configuring a service group as a global service group	582
About cluster faults	583
About the type of failure	583
Switching the service group back to the primary	583
About setting up a disaster recovery fire drill	584
About creating and configuring the fire drill service group manually	585
About configuring the fire drill service group using the Fire Drill Setup wizard	588
Verifying a successful fire drill	590
Scheduling a fire drill	591
Multi-tiered application support using the RemoteGroup agent in a global environment	591
Test scenario for a multi-tiered environment	593
About the main.cf file for cluster 1	594
About the main.cf file for cluster 2	595
About the main.cf file for cluster 3	596
About the main.cf file for cluster 4	597

Chapter 19

Administering global clusters from Cluster Manager (Java console)	599
About global clusters	599
Adding a remote cluster	600
Deleting a remote cluster	604
Administering global service groups	607
Converting local and global groups	607
Bringing a service group online in a remote cluster	610
Taking a service group offline in a remote cluster	610
Switching a service group to a remote cluster	611
Administering global heartbeats	611
Adding a global heartbeat	611
Modifying a global heartbeat	612
Deleting a global heartbeat	613

Chapter 20	Administering global clusters from the command line	614
	About administering global clusters from the command line	614
	About global querying in a global cluster setup	615
	Querying global cluster service groups	615
	Querying resources across clusters	616
	Querying systems	618
	Querying clusters	618
	Querying status	620
	Querying heartbeats	620
	Administering global service groups in a global cluster setup	622
	Administering resources in a global cluster setup	624
	Administering clusters in global cluster setup	624
	Managing cluster alerts in a global cluster setup	625
	Changing the cluster name in a global cluster setup	626
	Removing a remote cluster from a global cluster setup	627
	Administering heartbeats in a global cluster setup	627
Chapter 21	Setting up replicated data clusters	629
	About replicated data clusters	629
	How VCS replicated data clusters work	630
	About setting up a replicated data cluster configuration	631
	About typical replicated data cluster configuration	631
	About setting up replication	632
	Configuring the service groups	633
	Configuring the service group dependencies	634
	About migrating a service group	634
	Switching the service group	635
	About setting up a fire drill	635
Chapter 22	Setting up campus clusters	636
	About campus cluster configuration	636
	VCS campus cluster requirements	637
	Typical VCS campus cluster setup	638
	How VCS campus clusters work	639
	About I/O fencing in campus clusters	643
	About setting up a campus cluster configuration	644
	Preparing to set up a campus cluster configuration	644
	Configuring I/O fencing to prevent data corruption	645
	Configuring VxVM disk groups for campus cluster configuration	645

	Configuring VCS service group for campus clusters	647
	Fire drill in campus clusters	647
	About the DiskGroupSnap agent	648
	About running a fire drill in a campus cluster	648
	Configuring the fire drill service group	649
	Running a successful fire drill in a campus cluster	649
Section 7	Troubleshooting and performance	651
Chapter 23	VCS performance considerations	652
	How cluster components affect performance	652
	How kernel components (GAB and LLT) affect performance	
	6 5 3	
	How the VCS engine (HAD) affects performance	653
	How agents affect performance	654
	How the VCS graphical user interfaces affect performance	655
	How cluster operations affect performance	655
	VCS performance consideration when booting a cluster system	
	656
	VCS performance consideration when a resource comes online	
	657
	VCS performance consideration when a resource goes offline	
	657
	VCS performance consideration when a service group comes	
	online	657
	VCS performance consideration when a service group goes offline	
	658
	VCS performance consideration when a resource fails	658
	VCS performance consideration when a system fails	659
	VCS performance consideration when a network link fails	660
	VCS performance consideration when a system panics	660
	VCS performance consideration when a service group switches	
	over	662
	VCS performance consideration when a service group fails over	
	663
	About scheduling class and priority configuration	663
	About priority ranges	663
	Default scheduling classes and priorities	664
	About configuring priorities for LLT threads for AIX	665
	CPU binding of HAD	665
	VCS agent statistics	667
	Tracking monitor cycle times	668

	VCS attributes enabling agent statistics	668
	About VCS tunable parameters	669
	About LLT tunable parameters	670
	About GAB tunable parameters	677
	About VXFEN tunable parameters	684
	About AMF tunable parameters	687
Chapter 24	Troubleshooting and recovery for VCS	690
	VCS message logging	691
	Log unification of VCS agent's entry points	692
	Enhancing First Failure Data Capture (FFDC) to troubleshoot VCS resource's unexpected behavior	692
	GAB message logging	693
	Enabling debug logs for agents	694
	Enabling debug logs for IMF	695
	Enabling debug logs for the VCS engine	695
	About debug log tags usage	696
	Gathering VCS information for support analysis	697
	Gathering LLT and GAB information for support analysis	699
	Gathering IMF information for support analysis	700
	Message catalogs	700
	Troubleshooting the VCS engine	702
	HAD diagnostics	702
	HAD restarts continuously	702
	DNS configuration issues cause GAB to kill HAD	703
	Seeding and I/O fencing	703
	Preonline IP check	703
	Troubleshooting Low Latency Transport (LLT)	704
	LLT startup script displays errors	704
	LLT detects cross links usage	704
	LLT link status messages	705
	Troubleshooting Group Membership Services/Atomic Broadcast (GAB)	707
	GAB timer issues	707
	Delay in port reopen	708
	Node panics due to client process failure	708
	Troubleshooting VCS startup	709
	"VCS:10623 local configuration missing"	709
	"VCS:10623 local configuration invalid"	709
	"VCS:11032 registration failed. Exiting"	710
	"Waiting for cluster membership."	710
	Troubleshooting Intelligent Monitoring Framework (IMF)	710

- Troubleshooting service groups 713
 - VCS does not automatically start service group 713
 - System is not in RUNNING state 713
 - Service group not configured to run on the system 713
 - Service group not configured to autostart 713
 - Service group is frozen 713
 - Failover service group is online on another system 714
 - A critical resource faulted 714
 - Service group autodisabled 714
 - Service group is waiting for the resource to be brought online/taken
offline 714
 - Service group is waiting for a dependency to be met. 715
 - Service group not fully probed. 715
 - Service group does not fail over to the forecasted system 716
 - Service group does not fail over to the BiggestAvailable system
even if FailOverPolicy is set to BiggestAvailable 716
 - Restoring metering database from backup taken by VCS 717
 - Initialization of metering database fails 718
 - Error message appears during service group failover or switch
..... 719
- Troubleshooting resources 719
 - Service group brought online due to failover 719
 - Waiting for service group states 719
 - Waiting for child resources 719
 - Waiting for parent resources 719
 - Waiting for resource to respond 720
 - Agent not running 720
 - The Monitor entry point of the disk group agent returns ONLINE
even if the disk group is disabled 720
- Troubleshooting sites 721
 - Online propagate operation was initiated but service group failed
to be online 721
 - VCS panics nodes in the preferred site during a network-split ...
7 2 1
 - Configuring of stretch site fails 721
 - Renaming a Site 722
- Troubleshooting I/O fencing 722
 - Node is unable to join cluster while another node is being ejected
..... 722
 - The vxfcntlshdw utility fails when SCSI TEST UNIT READY
command fails 722
 - Manually removing existing keys from SCSI-3 disks 723
 - System panics to prevent potential data corruption 724

Cluster ID on the I/O fencing key of coordinator disk does not match the local cluster's ID	725
Fencing startup reports preexisting split-brain	726
Registered keys are lost on the coordinator disks	728
Replacing defective disks when the cluster is offline	729
The vxfsnwap utility exits if rcp or scp commands are not functional	731
Troubleshooting CP server	731
Troubleshooting server-based fencing on the VCS cluster nodes	733
Issues during online migration of coordination points	734
Troubleshooting notification	735
Notifier is configured but traps are not seen on SNMP console.	735
Troubleshooting and recovery for global clusters	735
Disaster declaration	736
Lost heartbeats and the inquiry mechanism	736
VCS alerts	737
Troubleshooting the steward process	739
Troubleshooting licensing	739
Validating license keys	740
Licensing error messages	741
Troubleshooting secure configurations	742
FIPS mode cannot be set	742
Troubleshooting wizard-based configuration issues	742
Running the 'hastop -all' command detaches virtual disks	742
Troubleshooting issues with the Veritas High Availability view	743
Veritas High Availability view does not display the application monitoring status	743
Veritas High Availability view may freeze due to special characters in application display name	743
In the Veritas High Availability tab, the Add Failover System link is dimmed	744
Section 8 Appendixes	745
Appendix A VCS user privileges—administration matrices	746
About administration matrices	746
Administration matrices	746
Agent Operations (haagent)	747
Attribute Operations (haattr)	747

	Cluster Operations (haclus, haconf)	747
	Service group operations (hagrp)	748
	Heartbeat operations (hahb)	749
	Log operations (halog)	750
	Resource operations (hares)	750
	System operations (hasys)	751
	Resource type operations (hatype)	752
	User operations (hauser)	752
Appendix B	VCS commands: Quick reference	754
	About this quick reference for VCS commands	754
	VCS command line reference	754
Appendix C	Cluster and system states	758
	Remote cluster states	758
	Examples of cluster state transitions	759
	System states	760
	Examples of system state transitions	762
Appendix D	VCS attributes	763
	About attributes and their definitions	763
	Resource attributes	764
	Resource type attributes	773
	Service group attributes	789
	System attributes	816
	Cluster attributes	831
	Heartbeat attributes (for global clusters)	846
	Remote cluster attributes	848
	Site attributes	851
Appendix E	Accessibility and VCS	853
	About accessibility in VCS	853
	Navigation and keyboard shortcuts	853
	Navigation in the Java Console	854
	Navigation in the Web console	854
	Support for accessibility settings	854
	Support for assistive technologies	854
Index		856

Clustering concepts and terminology

- [Chapter 1. Introducing Cluster Server](#)
- [Chapter 2. About cluster topologies](#)
- [Chapter 3. VCS configuration concepts](#)

Introducing Cluster Server

This chapter includes the following topics:

- [About Cluster Server](#)
- [About cluster control guidelines](#)
- [About the physical components of VCS](#)
- [Logical components of VCS](#)
- [Putting the pieces together](#)

About Cluster Server

Cluster Server (VCS) connects multiple, independent systems into a management framework for increased availability. Each system, or node, runs its own operating system and cooperates at the software level to form a cluster. VCS links commodity hardware with intelligent software to provide application failover and control. When a node or a monitored application fails, other nodes can take predefined actions to take over and bring up services elsewhere in the cluster.

How VCS detects failure

VCS detects failure of an application by issuing specific commands, tests, or scripts to monitor the overall health of an application. VCS also determines the health of underlying resources by supporting the applications such as file systems and network interfaces.

VCS uses a redundant network heartbeat to differentiate between the loss of a system and the loss of communication between systems. VCS can also use SCSI3-based membership coordination and data protection for detecting failure on a node and on fencing.

See “[About cluster control, communications, and membership](#)” on page 44.

How VCS ensures application availability

When VCS detects an application or node failure, VCS brings application services up on a different node in a cluster.

[Figure 1-1](#) shows how VCS virtualizes IP addresses and system names, so client systems continue to access the application and are unaware of which server they use.

Figure 1-1 VCS virtualizes IP addresses and system names to ensure application availability

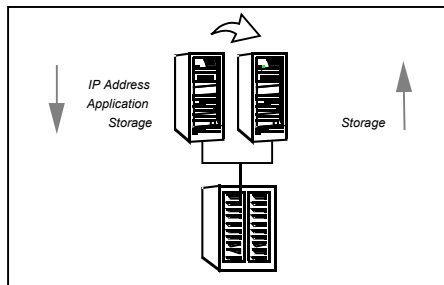

For example, in a two-node cluster consisting of db-server1 and db-server2, a virtual address may be called db-server. Clients access db-server and are unaware of which physical server hosts the db-server.

About switchover and failover

Switchover and failover are the processes of bringing up application services on a different node in a cluster by VCS. The difference between the two processes is as follows:

Switchover	A switchover is an orderly shutdown of an application and its supporting resources on one server and a controlled startup on another server.
Failover	A failover is similar to a switchover, except the ordered shutdown of applications on the original node may not be possible due to failure of hardware or services, so the services are started on another node.

About cluster control guidelines

Most applications can be placed under cluster control provided the following guidelines are met:

- Defined start, stop, and monitor procedures
 See “[Defined start, stop, and monitor procedures](#)” on page 29.
- Ability to restart in a known state
 See “[Ability to restart the application in a known state](#)” on page 30.
- Ability to store required data on shared disks
 See “[External data storage](#)” on page 30.
- Adherence to license requirements and host name dependencies
 See “[Licensing and host name issues](#)” on page 31.

Defined start, stop, and monitor procedures

The following table describes the defined procedures for starting, stopping, and monitoring the application to be clustered:

Start procedure	<p>The application must have a command to start it and all resources it may require. VCS brings up the required resources in a specific order, then brings up the application by using the defined start procedure.</p> <p>For example, to start an Oracle database, VCS must know which Oracle utility to call, such as sqlplus. VCS must also know the Oracle user, instance ID, Oracle home directory, and the pfile.</p>
Stop procedure	<p>An individual instance of the application must be capable of being stopped without affecting other instances.</p> <p>For example, You cannot kill all httpd processes on a Web server because it also stops other Web servers.</p> <p>If VCS cannot stop an application cleanly, it may call for a more forceful method, like a kill signal. After a forced stop, a clean-up procedure may be required for various process-specific and application-specific items that may be left behind. These items include shared memory segments or semaphores.</p>

Monitor procedure The application must have a monitor procedure that determines if the specified application instance is healthy. The application must allow individual monitoring of unique instances.

For example, the monitor procedure for a Web server connects to the specified server and verifies that it serves Web pages. In a database environment, the monitoring application can connect to the database server and perform SQL commands to verify read and write access to the database.

If a test closely matches what a user does, it is more successful in discovering problems. Balance the level of monitoring by ensuring that the application is up and by minimizing monitor overhead.

Ability to restart the application in a known state

When you take an application offline, the application must close out all tasks, store data properly on shared disk, and exit. Stateful servers must not keep that state of clients in memory. States should be written to shared storage to ensure proper failover.

Commercial databases such as Oracle, Sybase, or SQL Server are good examples of well-written, crash-tolerant applications. On any client SQL request, the client is responsible for holding the request until it receives acknowledgement from the server. When the server receives a request, it is placed in a special redo log file. The database confirms that the data is saved before it sends an acknowledgement to the client. After a server crashes, the database recovers to the last-known committed state by mounting the data tables and by applying the redo logs. This returns the database to the time of the crash. The client resubmits any outstanding client requests that are unacknowledged by the server, and all others are contained in the redo logs.

If an application cannot recover gracefully after a server crashes, it cannot run in a cluster environment. The takeover server cannot start up because of data corruption and other problems.

External data storage

The application must be capable of storing all required data and configuration information on shared disks. The exception to this rule is a true shared nothing cluster.

See [“About shared nothing clusters”](#) on page 59.

To meet this requirement, you may need specific setup options or soft links. For example, a product may only install in `/usr/local`. This limitation requires one of the

following options: linking `/usr/local` to a file system that is mounted from the shared storage device or mounting file system from the shared device on `/usr/local`.

The application must also store data to disk instead of maintaining it in memory. The takeover system must be capable of accessing all required information. This requirement precludes the use of anything inside a single system inaccessible by the peer. NVRAM accelerator boards and other disk caching mechanisms for performance are acceptable, but must be done on the external array and not on the local host.

Licensing and host name issues

The application must be capable of running on all servers that are designated as potential hosts. This requirement means strict adherence to license requirements and host name dependencies. A change of host names can lead to significant management issues when multiple systems have the same host name after an outage. To create custom scripts to modify a system host name on failover is not recommended. Veritas recommends that you configure applications and licenses to run properly on all hosts.

About the physical components of VCS

A VCS cluster comprises of systems that are connected with a dedicated communications infrastructure. VCS refers to a system that is part of a cluster as a node.

Each cluster has a unique cluster ID. Redundant cluster communication links connect systems in a cluster.

See [“About VCS nodes”](#) on page 31.

See [“About shared storage”](#) on page 32.

See [“About networking”](#) on page 32.

About VCS nodes

VCS nodes host the service groups (managed applications and their resources). Each system is connected to networking hardware, and usually to storage hardware also. The systems contain components to provide resilient management of the applications and to start and stop agents.

Nodes can be individual systems, or they can be created with domains or partitions on enterprise-class systems or on supported virtual machines. Individual cluster nodes each run their own operating system and possess their own boot device. Each node must run the same operating system within a single VCS cluster.

VCS is capable of supporting clusters with up to 64 nodes. Veritas has tested and qualified configurations of up to 32 nodes at the time of the release. For more updates on this support, review the Late-Breaking News TechNote on the Veritas Technical Support Web site :

https://www.veritas.com/support/en_US/article.000107213

You can configure applications to run on specific nodes within the cluster.

About shared storage

Storage is a key resource of most applications services, and therefore most service groups. You can start a managed application on a system that has access to its associated data files. Therefore, a service group can only run on all systems in the cluster if the storage is shared across all systems. In many configurations, a storage area network (SAN) provides this requirement.

See “[Cluster topologies and storage configurations](#)” on page 57.

You can use I/O fencing technology for data protection. I/O fencing blocks access to shared storage from any system that is not a current and verified member of the cluster.

See “[About the I/O fencing module](#)” on page 47.

See “[About the I/O fencing algorithm](#)” on page 341.

About networking

Networking in the cluster is used for the following purposes:

- Communications between the cluster nodes and the customer systems.
- Communications between the cluster nodes.

See “[About cluster control, communications, and membership](#)” on page 44.

Logical components of VCS

VCS is comprised of several components that provide the infrastructure to cluster an application.

See “[About resources and resource dependencies](#)” on page 33.

See “[Categories of resources](#)” on page 35.

See “[About resource types](#)” on page 35.

See “[About service groups](#)” on page 36.

See “[Types of service groups](#)” on page 36.

See “[About the ClusterService group](#)” on page 37.

See “[About the cluster UUID](#)” on page 37.

See “[About agents in VCS](#)” on page 38.

See “[About agent functions](#)” on page 39.

See “[VCS agent framework](#)” on page 44.

See “[About cluster control, communications, and membership](#)” on page 44.

See “[About security services](#)” on page 47.

See “[Components for administering VCS](#)” on page 48.

About resources and resource dependencies

Resources are hardware or software entities that make up the application. Disk groups and file systems, network interface cards (NIC), IP addresses, and applications are a few examples of resources.

Resource dependencies indicate resources that depend on each other because of application or operating system requirements. Resource dependencies are graphically depicted in a hierarchy, also called a tree, where the resources higher up (parent) depend on the resources lower down (child).

[Figure 1-2](#) shows the hierarchy for a database application.

Figure 1-2 Sample resource dependency graph

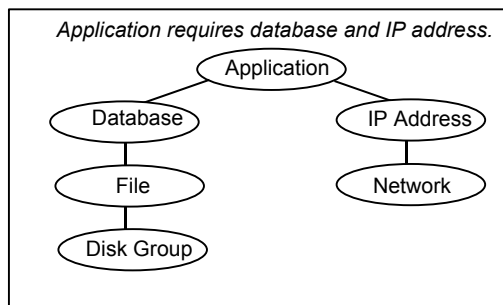

Resource dependencies determine the order in which resources are brought online or taken offline. For example, you must import a disk group before volumes in the disk group start, and volumes must start before you mount file systems. Conversely, you must unmount file systems before volumes stop, and volumes must stop before you deport disk groups.

A parent is brought online after each child is brought online, and this continues up the tree, until finally the application starts. Conversely, to take a managed application

offline, VCS stops resources by beginning at the top of the hierarchy. In this example, the application stops first, followed by the database application. Next the IP address and file systems stop concurrently. These resources do not have any resource dependency between them, and this continues down the tree.

Child resources must be brought online before parent resources are brought online. Parent resources must be taken offline before child resources are taken offline. If resources do not have parent-child interdependencies, they can be brought online or taken offline concurrently.

Atleast resource dependency

A new type of resource dependency has been introduced wherein a parent resource can depend on a set of child resources. The parent resource is brought online or remains online only if a minimum number of child resources in this resource set are online.

For example, if an application depends on five IPs and if this application has to be brought online or has to remain online, at least two IPs must be online. You can configure this dependency as shown in the figure below. See [“Configuring atleast resource dependency”](#) on page 235.

The system creates a set of child IP resources and the application resource will depend on this set. For this example, the assumption is that the application resource is res1 and the child IP resources are res2, res3, res4, res5, and res6.

Figure 1-3 Atleast resource dependency graph

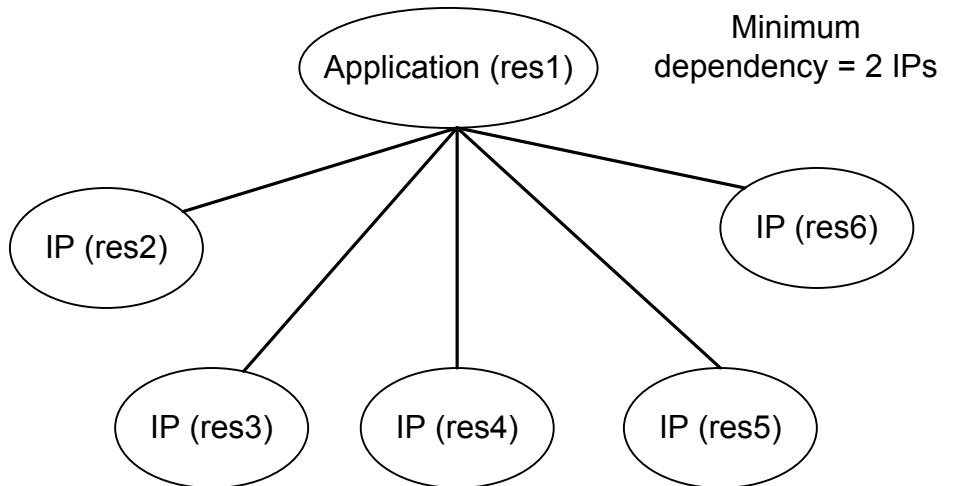

If two or more IP resources come online, the application attempts to come online. If the number of online resources falls below the minimum requirement, (in this case: 2), resource fault is propagated up the resource dependency tree.

Note: Veritas InfoScale Operations Manager and Java GUI does not support atleast resource dependency and so the dependency is shown as normal resource dependency.

Categories of resources

Different types of resources require different levels of control.

[Table 1-1](#) describes the three categories of VCS resources.

Table 1-1 Categories of VCS resources

VCS resources	VCS behavior
On-Off	VCS starts and stops On-Off resources as required. For example, VCS imports a disk group when required, and deports it when it is no longer needed.
On-Only	VCS starts On-Only resources, but does not stop them. For example, VCS requires NFS daemons to be running to export a file system. VCS starts the daemons if required, but does not stop them if the associated service group is taken offline.
Persistent	These resources cannot be brought online or taken offline. For example, a network interface card cannot be started or stopped, but it is required to configure an IP address. A Persistent resource has an operation value of None. VCS monitors Persistent resources to ensure their status and operation. Failure of a Persistent resource triggers a service group failover.

About resource types

VCS defines a resource type for each resource it manages. For example, you can configure the NIC resource type to manage network interface cards. Similarly, you can configure an IP address using the IP resource type.

VCS includes a set of predefined resources types. For each resource type, VCS has a corresponding agent, which provides the logic to control resources.

See [“About agents in VCS”](#) on page 38.

About service groups

A service group is a virtual container that contains all the hardware and software resources that are required to run the managed application. Service groups allow VCS to control all the hardware and software resources of the managed application as a single unit. When a failover occurs, resources do not fail over individually; the entire service group fails over. If more than one service group is on a system, a group can fail over without affecting the others.

[Figure 1-4](#) shows a typical database service group.

Figure 1-4 Typical database service group

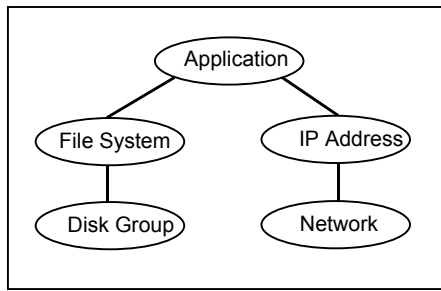

A single node can host any number of service groups, each providing a discrete service to networked clients. If the server crashes, all service groups on that node must be failed over elsewhere.

Service groups can be dependent on each other. For example, a managed application might be a finance application that is dependent on a database application. Because the managed application consists of all components that are required to provide the service, service group dependencies create more complex managed applications. When you use service group dependencies, the managed application is the entire dependency tree.

See [“About service group dependencies”](#) on page 475.

Types of service groups

VCS service groups fall in three main categories: failover, parallel, and hybrid.

About failover service groups

A failover service group runs on one system in the cluster at a time. Failover groups are used for most applications that do not support multiple systems to simultaneously access the application’s data.

About parallel service groups

A parallel service group runs simultaneously on more than one system in the cluster. A parallel service group is more complex than a failover group. Parallel service groups are appropriate for applications that manage multiple application instances that run simultaneously without data corruption.

About hybrid service groups

A hybrid service group is for replicated data clusters and is a combination of the failover and parallel service groups. It behaves as a failover group within a system zone or site and a parallel group across system zones or site.

A hybrid service group cannot fail over across system zones. VCS allows a switch operation on a hybrid group only if both systems are within the same system zone or site. If no systems exist within a zone for failover, VCS calls the nofailover trigger on the lowest numbered node.

See [“About service group dependencies”](#) on page 475.

See [“About the nofailover event trigger”](#) on page 520.

About the ClusterService group

The ClusterService group is a special purpose service group, which contains resources that are required by VCS components.

The group contains resources for the following items:

- Notification
- Wide-area connector (WAC) process, which is used in global clusters

By default, the ClusterService group can fail over to any node despite restrictions such as the node being frozen. However, if you disable the AutoAddSystemToCSG attribute, you can control the nodes that are included in the SystemList. The ClusterService group is the first service group to come online and cannot be autodisabled. The ClusterService group comes online on the first node that transitions to the running state. The VCS engine discourages the action of taking the group offline manually.

About the cluster UUID

When you install VCS using the product installer, the installer generates a universally unique identifier (UUID) for the cluster. This value is the same across all the nodes in the cluster. The value is defined in the ClusterUUID or CID attribute.

See [“Cluster attributes”](#) on page 831.

If you do not use the product installer to install VCS, you must run the `uuidconfig.pl` utility to configure the UUID for the cluster.

See [“Configuring and unconfiguring the cluster UUID value”](#) on page 242.

About agents in VCS

Agents are multi-threaded processes that provide the logic to manage resources. VCS has one agent per resource type. The agent monitors all resources of that type; for example, a single IP agent manages all IP resources.

When the agent starts, it obtains the necessary configuration information from the VCS engine. It then periodically monitors the resources, and updates the VCS engine with the resource status. The agents that support Intelligent Monitoring Framework (IMF) also monitors the resources asynchronously. These agents register with the IMF notification module for resource state change notifications. Enabling IMF for process-based and mount-based agents can give you significant performance benefits in terms of system resource utilization and also aid faster failover of applications.

See [“About resource monitoring”](#) on page 40.

The action to bring a resource online or take it offline differs significantly for each resource type. For example, when you bring a disk group online, it requires importing the disk group. But, when you bring a database online, it requires that you start the database manager process and issue the appropriate startup commands.

VCS monitors resources when they are online and offline to ensure that they are not started on systems where they are not supposed to run. For this reason, VCS starts the agent for any resource that is configured to run on a system when the cluster is started. If no resources of a particular type are configured, the agent is not started. For example, if no Oracle resources exist in your configuration, the Oracle agent is not started on the system.

Certain agents can identify when an application has been intentionally shut down outside of VCS control. For agents that support this functionality, if an administrator intentionally shuts down an application outside of VCS control, VCS does not treat it as a fault. VCS sets the service group state as offline or partial, which depends on the state of other resources in the service group.

This feature allows administrators to stop applications that do not cause a failover. The feature is available for V51 agents. Agent versions are independent of VCS versions. For example, VCS 6.0 can run V40, V50, V51, and V52 agents for backward compatibility.

See [“VCS behavior for resources that support the intentional offline functionality”](#) on page 437.

About agent functions

Agents carry out specific functions on resources. The functions an agent performs are called entry points.

For details on agent functions, see the *Cluster Server Agent Developer's Guide*.

Table 1-2 describes the agent functions.

Table 1-2 Agent functions

Agent functions	Role
Online	Brings a specific resource ONLINE from an OFFLINE state.
Offline	Takes a resource from an ONLINE state to an OFFLINE state.
Monitor	<p>Tests the status of a resource to determine if the resource is online or offline.</p> <p>The function runs at the following times:</p> <ul style="list-style-type: none"> ■ During initial node startup, to probe and determine the status of all resources on the system. ■ After every online and offline operation. ■ Periodically, to verify that the resource remains in its correct state. Under normal circumstances, the monitor entry point is run every 60 seconds when a resource is online. The entry point is run every 300 seconds when a resource is expected to be offline. ■ When you probe a resource using the following command: <pre># hares -probe res_name -sys system_name.</pre>
imf_init	Initializes the agent to interface with the IMF notification module. This function runs when the agent starts up.
imf_getnotification	Gets notification about resource state changes. This function runs after the agent initializes with the IMF notification module. This function continuously waits for notification and takes action on the resource upon notification.
imf_register	Registers or unregisters resource entities with the IMF notification module. For example, the function registers the PID for online monitoring of a process. This function runs for each resource after the resource goes into steady state (online or offline).

Table 1-2 Agent functions (*continued*)

Agent functions	Role
Clean	Cleans up after a resource fails to come online, fails to go offline, or fails to detect as ONLINE when resource is in an ONLINE state. The clean entry point is designed to clean up after an application fails. The function ensures that the host system is returned to a valid state. For example, the clean function may remove shared memory segments or IPC resources that are left behind by a database.
Action	Performs actions that can be completed in a short time and which are outside the scope of traditional activities such as online and offline. Some agents have predefined action scripts that you can run by invoking the action function.
Info	<p>Retrieves specific information for an online resource.</p> <p>The retrieved information is stored in the resource attribute ResourceInfo. This function is invoked periodically by the agent framework when the resource type attribute InfoInterval is set to a non-zero value. The InfoInterval attribute indicates the period after which the info function must be invoked. For example, the Mount agent may use this function to indicate the space available on the file system.</p> <p>To see the updated information, you can invoke the info agent function explicitly from the command line interface by running the following command:</p> <pre data-bbox="555 999 1201 1052">hares -refreshinfo res [-sys system] -clus cluster -localclus</pre>

About resource monitoring

VCS agents poll the resources periodically based on the monitor interval (in seconds) value that is defined in the MonitorInterval or in the OfflineMonitorInterval resource type attributes. After each monitor interval, VCS invokes the monitor agent function for that resource. For example, for process offline monitoring, the process agent's monitor agent function corresponding to each process resource scans the process table in each monitor interval to check whether the process has come online. For process online monitoring, the monitor agent function queries the operating system for the status of the process id that it is monitoring. In case of the mount agent, the monitor agent function corresponding to each mount resource checks if the block device is mounted on the mount point or not. In order to determine this, the monitor function does operations such as mount table scans or runs `statfs` equivalents.

With intelligent monitoring framework (IMF), VCS supports intelligent resource monitoring in addition to poll-based monitoring. IMF is an extension to the VCS

agent framework. You can enable or disable the intelligent monitoring functionality of the VCS agents that are IMF-aware. For a list of IMF-aware agents, see the *Cluster Server Bundled Agents Reference Guide*.

See [“How intelligent resource monitoring works”](#) on page 42.

See [“Enabling and disabling intelligent resource monitoring for agents manually”](#) on page 227.

See [“Enabling and disabling IMF for agents by using script”](#) on page 229.

Poll-based monitoring can consume a fairly large percentage of system resources such as CPU and memory on systems with a huge number of resources. This not only affects the performance of running applications, but also places a limit on how many resources an agent can monitor efficiently.

However, with IMF-based monitoring you can either eliminate poll-based monitoring completely or reduce its frequency. For example, for process offline and online monitoring, you can completely avoid the need for poll-based monitoring with IMF-based monitoring enabled for processes. Similarly for vxfs mounts, you can eliminate the poll-based monitoring with IMF monitoring enabled. Such reduction in monitor footprint will make more system resources available for other applications to consume.

Note: Intelligent Monitoring Framework for mounts is supported only for the VxFS, CFS, and NFS mount types.

With IMF-enabled agents, VCS will be able to effectively monitor larger number of resources.

Thus, intelligent monitoring has the following benefits over poll-based monitoring:

- Provides faster notification of resource state changes
- Reduces VCS system utilization due to reduced monitor function footprint
- Enables VCS to effectively monitor a large number of resources

Consider enabling IMF for an agent in the following cases:

- You have a large number of process resources or mount resources under VCS control.
- You have any of the agents that are IMF-aware.

For information about IMF-aware agents, see the following documentation:

- See the *Cluster Server Bundled Agents Reference Guide* for details on whether your bundled agent is IMF-aware.

- See the *Storage Foundation Cluster File System High Availability Installation Guide* for IMF-aware agents in CFS environments.

How intelligent resource monitoring works

When an IMF-aware agent starts up, the agent initializes with the IMF notification module. After the resource moves to a steady state, the agent registers the details that are required to monitor the resource with the IMF notification module. For example, the process agent registers the PIDs of the processes with the IMF notification module. The agent's `imf_getnotification` function waits for any resource state changes. When the IMF notification module notifies the `imf_getnotification` function about a resource state change, the agent framework runs the monitor agent function to ascertain the state of that resource. The agent notifies the state change to VCS which takes appropriate action.

A resource moves into a steady state when any two consecutive monitor agent functions report the state as ONLINE or as OFFLINE. The following are a few examples of how steady state is reached.

- When a resource is brought online, a monitor agent function is scheduled after the online agent function is complete. Assume that this monitor agent function reports the state as ONLINE. The next monitor agent function runs after a time interval specified by the `MonitorInterval` attribute. If this monitor agent function too reports the state as ONLINE, a steady state is achieved because two consecutive monitor agent functions reported the resource state as ONLINE. After the second monitor agent function reports the state as ONLINE, the registration command for IMF is scheduled. The resource is registered with the IMF notification module and the resource comes under IMF control. The default value of `MonitorInterval` is 60 seconds.

A similar sequence of events applies for taking a resource offline.

- Assume that IMF is disabled for an agent type and you enable IMF for the agent type when the resource is ONLINE. The next monitor agent function occurs after a time interval specified by `MonitorInterval`. If this monitor agent function again reports the state as ONLINE, a steady state is achieved because two consecutive monitor agent functions reported the resource state as ONLINE.

A similar sequence of events applies if the resource is OFFLINE initially and the next monitor agent function also reports the state as OFFLINE after you enable IMF for the agent type.

See [“About the IMF notification module”](#) on page 47.

About Open IMF

The Open IMF architecture builds further upon the IMF functionality by enabling you to get notifications about events that occur in user space.

The architecture uses an IMF daemon (IMFD) that collects notifications from the user space notification providers (USNPs) and passes the notifications to the AMF driver, which in turn passes these on to the appropriate agent. IMFD starts on the first registration with IMF by an agent that requires Open IMF.

The Open IMF architecture provides the following benefits:

- IMF can group events of different types under the same VCS resource and is the central notification provider for kernel space events and user space events.
- More agents can become IMF-aware by leveraging the notifications that are available only from user space.
- Agents can get notifications from IMF without having to interact with USNPs.

For example, Open IMF enables the AMF driver to get notifications from vxnotify, the notification provider for Veritas Volume Manager. The AMF driver passes these notifications on to the DiskGroup agent. For more information on the DiskGroup agent, see the *Cluster Server Bundled Agents Reference Guide*.

Agent classifications

The different kinds of agents that work with VCS include bundled agents, enterprise agents, and custom agents.

About bundled agents

Bundled agents are packaged with VCS. They include agents for Disk, Mount, IP, and various other resource types.

See the *Cluster Server Bundled Agents Reference Guide*.

About enterprise agents

Enterprise agents control third party applications. These include agents for Oracle, Sybase, and DB2.

See the following documentation for more information:

- *Cluster Server Agent for Oracle Installation and Configuration Guide*
- *Cluster Server Agent for Sybase Installation and Configuration Guide*
- *Cluster Server Agent for DB2 Installation and Configuration Guide*

About custom agents

Custom agents are agents that customers or Veritas consultants develop. Typically, agents are developed because the user requires control of an application that the current bundled or enterprise agents do not support.

See the *Cluster Server Agent Developer's Guide*.

VCS agent framework

The VCS agent framework is a set of common, predefined functions that are compiled into each agent. These functions include the ability to connect to the Veritas High Availability Engine (HAD) and to understand common configuration attributes. The agent framework frees the developer from developing functions for the cluster; the developer instead can focus on controlling a specific resource type.

VCS agent framework also includes IMF which enables asynchronous monitoring of resources and instantaneous state change notifications.

See [“About resource monitoring”](#) on page 40.

For more information on developing agents, see the *Cluster Server Agent Developer's Guide*.

About cluster control, communications, and membership

Cluster communications ensure that VCS is continuously aware of the status of each system's service groups and resources. They also enable VCS to recognize which systems are active members of the cluster, which have joined or left the cluster, and which have failed.

See [“About the high availability daemon \(HAD\)”](#) on page 44.

See [“About the HostMonitor daemon”](#) on page 45.

See [“About Group Membership Services and Atomic Broadcast \(GAB\)”](#) on page 46.

See [“About Low Latency Transport \(LLT\)”](#) on page 46.

See [“About the I/O fencing module”](#) on page 47.

See [“About the IMF notification module”](#) on page 47.

About the high availability daemon (HAD)

The VCS high availability daemon (HAD) runs on each system.

Also known as the Veritas High Availability Engine, HAD is responsible for the following functions:

- Builds the running cluster configuration from the configuration files
- Distributes the information when new nodes join the cluster
- Responds to operator input
- Takes corrective action when something fails.

The engine uses agents to monitor and manage resources. It collects information about resource states from the agents on the local system and forwards it to all cluster members.

The local engine also receives information from the other cluster members to update its view of the cluster. HAD operates as a replicated state machine (RSM). The engine that runs on each node has a completely synchronized view of the resource status on each node. Each instance of HAD follows the same code path for corrective action, as required.

The RSM is maintained through the use of a purpose-built communications package. The communications package consists of the protocols Low Latency Transport (LLT) and Group Membership Services and Atomic Broadcast (GAB).

See [“About inter-system cluster communications”](#) on page 309.

The hashadow process monitors HAD and restarts it when required.

About the HostMonitor daemon

VCS also starts HostMonitor daemon when the VCS engine comes up. The VCS engine creates a VCS resource VCSshm of type HostMonitor and a VCSshm service group. The VCS engine does not add these objects to the main.cf file. Do not modify or delete these VCS components. VCS uses the HostMonitor daemon to monitor the resource utilization of CPU, Memory, and Swap. VCS reports to the engine log if the resources cross the threshold limits that are defined for the resources. The HostMonitor daemon also monitors the available capacity of CPU, memory, and Swap in absolute terms, enabling the VCS engine to make dynamic decisions about failing over an application to the biggest available or best suitable system.

VCS deletes user-defined VCS objects that use the HostMonitor object names. If you had defined the following objects in the main.cf file using the reserved words for the HostMonitor daemon, then VCS deletes these objects when the VCS engine starts:

- Any group that you defined as VCSshm along with all its resources.
- Any resource type that you defined as HostMonitor along with all the resources of such resource type.
- Any resource that you defined as VCSshm.

See [“VCS keywords and reserved words”](#) on page 73.

You can control the behavior of the HostMonitor daemon using the Statistics attribute.

See [“Cluster attributes”](#) on page 831.

About Group Membership Services and Atomic Broadcast (GAB)

The Group Membership Services and Atomic Broadcast protocol (GAB) is responsible for the following cluster membership and cluster communications functions:

- Cluster Membership

GAB maintains cluster membership by receiving input on the status of the heartbeat from each node by LLT. When a system no longer receives heartbeats from a peer, it marks the peer as DOWN and excludes the peer from the cluster. In VCS, memberships are sets of systems participating in the cluster.

VCS has the following types of membership:

 - A regular membership includes systems that communicate with each other across more than one network channel.
 - A jeopardy membership includes systems that have only one private communication link.
 - A visible membership includes systems that have GAB running but the GAB client is no longer registered with GAB.
- Cluster Communications

GAB's second function is reliable cluster communications. GAB provides guaranteed delivery of point-to-point and broadcast messages to all nodes. The Veritas High Availability Engine uses a private IOCTL (provided by GAB) to tell GAB that it is alive.

About Low Latency Transport (LLT)

VCS uses private network communications between cluster nodes for cluster maintenance. The Low Latency Transport functions as a high-performance, low-latency replacement for the IP stack, and is used for all cluster communications. Veritas recommends at least two independent networks between all cluster nodes.

For detailed information on the setting up networks, see *Cluster Server Configuration and Upgrade Guide*.

These networks provide the required redundancy in the communication path and enable VCS to differentiate between a network failure and a system failure.

LLT has the following two major functions:

- Traffic distribution

LLT distributes (load balances) internode communication across all available private network links. This distribution means that all cluster communications are evenly distributed across all private network links (maximum eight) for

performance and fault resilience. If a link fails, traffic is redirected to the remaining links.

- **Heartbeat**
LLT is responsible for sending and receiving heartbeat traffic over network links. The Group Membership Services function of GAB uses this heartbeat to determine cluster membership.

About the I/O fencing module

The I/O fencing module implements a quorum-type functionality to ensure that only one cluster survives a split of the private network. I/O fencing also provides the ability to perform SCSI-3 persistent reservations on failover. The shared disk groups offer complete protection against data corruption by nodes that are assumed to be excluded from cluster membership.

See [“About the I/O fencing algorithm”](#) on page 341.

About the IMF notification module

The notification module of Intelligent Monitoring Framework (IMF) is the Asynchronous Monitoring Framework (AMF).

AMF is a kernel driver which hooks into system calls and other kernel interfaces of the operating system to get notifications on various events such as:

- When a process starts or stops.
- When a block device gets mounted or unmounted from a mount point.
- When a WPAR starts or stops.

AMF also interacts with the Intelligent Monitoring Framework Daemon (IMFD) to get disk group related notifications. AMF relays these notifications to various VCS Agents that are enabled for intelligent monitoring.

See [“About Open IMF”](#) on page 42.

WPAR agent also uses AMF kernel driver for asynchronous event notifications.

See [“About resource monitoring”](#) on page 40.

See [“About cluster control, communications, and membership”](#) on page 44.

About security services

VCS uses the VCS Authentication Service to provide secure communication between cluster nodes. VCS uses digital certificates for authentication and uses SSL to encrypt communication over the public network.

In secure mode:

- VCS uses platform-based authentication.
- VCS does not store user passwords.
- All VCS users are system and domain users and are configured using fully-qualified user names. For example, `administrator@vcsdomain`. VCS provides a single sign-on mechanism, so authenticated users do not need to sign on each time to connect to a cluster.

For secure communication, VCS components acquire credentials from the authentication broker that is configured on the local system. In VCS 6.0 and later, a root and authentication broker is automatically deployed on each node when a secure cluster is configured. The acquired certificate is used during authentication and is presented to clients for the SSL handshake.

VCS and its components specify the account name and the domain in the following format:

- **HAD Account**

```
name = HAD
domain = VCS_SERVICES@Cluster UUID
```

- **CmdServer**

```
name = CMDSERVER
domain = VCS_SERVICES@Cluster UUID
```

For instructions on how to set up Security Services while setting up the cluster, see the Cluster Server installation documentation.

See [“Enabling and disabling secure mode for the cluster”](#) on page 248.

Components for administering VCS

VCS provides several components to administer clusters.

[Table 1-3](#) describes the components that VCS provides to administer clusters:

Table 1-3 VCS components to administer clusters

VCS components	Description
Veritas InfoScale Operations Manager	<p>A Web-based graphical user interface for monitoring and administering the cluster.</p> <p>Install the Veritas InfoScale Operations Manager on a management server outside the cluster to manage multiple clusters.</p> <p>See the Veritas InfoScale Operations Manager documentation for more information.</p>
Cluster Manager (Java Console)	<p>A cross-platform Java-based graphical user interface that provides complete administration capabilities for your cluster. The console runs on any system inside or outside the cluster, on any operating system that supports Java. You cannot use Java Console if the external communication port for VCS is not open. By default, the external communication port for VCS is 14141.</p> <p>Note: Veritas Technologies recommends Veritas InfoScale Operations Manager be used as the graphical user interface to monitor and administer the cluster. Cluster Manager (Java Console) may not support features released in VCS 6.0 and later versions.</p> <p>See “About the Cluster Manager (Java Console)” on page 91.</p>
VCS command line interface (CLI)	<p>The VCS command-line interface provides a comprehensive set of commands for managing and administering the cluster.</p> <p>See “About administering VCS from the command line” on page 174.</p>

About Veritas InfoScale Operations Manager

Veritas InfoScale Operations Manager provides a centralized management console for Veritas InfoScale products. You can use Veritas InfoScale Operations Manager to monitor, visualize, and manage storage resources and generate reports.

Veritas recommends using Veritas InfoScale Operations Manager to manage Storage Foundation and Cluster Server environments.

You can download Veritas InfoScale Operations Manager from <https://sort.veritas.com/>.

Refer to the Veritas InfoScale Operations Manager documentation for installation, upgrade, and configuration instructions.

If you want to manage a single cluster using Cluster Manager (Java Console), a version is available for download from <https://www.veritas.com/product/storage-management/infoscale-operations-manager>.

You cannot manage the new features of this release using the Java Console. Cluster Server Management Console is deprecated.

Putting the pieces together

In this example, a two-node cluster exports an NFS file system to clients. Both nodes are connected to shared storage, which enables them to access the directories being shared. A single service group, NFS_Group, fails over between System A and System B, as necessary.

The Veritas High Availability Engine (HAD) reads the configuration file, determines what agents are required to control the resources in the service group, and starts the agents. HAD uses resource dependencies to determine the order in which to bring the resources online. VCS issues online commands to the corresponding agents in the correct order.

Figure 1-5 shows a dependency graph for the sample NFS group.

Figure 1-5

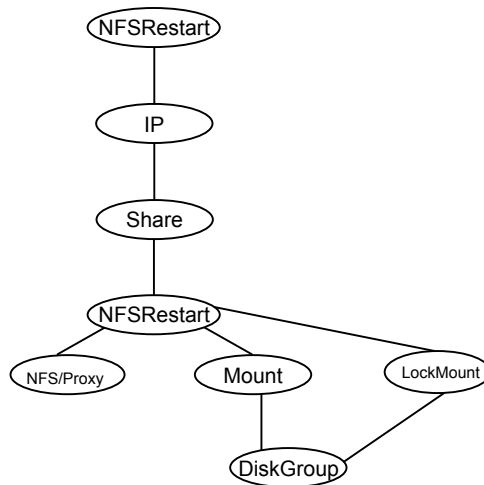

VCS starts the agents for DiskGroup, Mount, Share, NFS, NIC, IP, and NFSRestart on all systems that are configured to run NFS_Group.

The resource dependencies are configured as follows:

- The /home file system (configured as a Mount resource), requires that the disk group (configured as a DiskGroup resource) is online before you mount.
- The lower NFSRestart resource requires that the file system is mounted and that the NFS daemons (NFS) are running.

- The NFS export of the home file system (Share) requires that the lower NFSRestart resource is up.
- The high availability IP address, nfs_IP, requires that the file system (Share) is shared and that the network interface (NIC) is up.
- The upper NFSRestart resource requires that the IP address is up.
- The NFS daemons and the disk group have no child dependencies, so they can start in parallel.
- The NIC resource is a persistent resource and does not require starting.

You can configure the service group to start automatically on either node in the preceding example. It then can move or fail over to the second node on command or automatically if the first node fails. On failover or relocation, to make the resources offline on the first node, VCS begins at the top of the graph. When it starts them on the second node, it begins at the bottom.

About cluster topologies

This chapter includes the following topics:

- [Basic failover configurations](#)
- [About advanced failover configurations](#)
- [Cluster topologies and storage configurations](#)

Basic failover configurations

The basic failover configurations include asymmetric, symmetric, and N-to-1.

Asymmetric or active / passive configuration

In an asymmetric configuration, an application runs on a primary server. A dedicated redundant server is present to take over on any failure. The redundant server is not configured to perform any other functions.

[Figure 2-1](#) shows failover within an asymmetric cluster configuration, where a database application is moved, or failed over, from the master to the redundant server.

Figure 2-1 Asymmetric failover

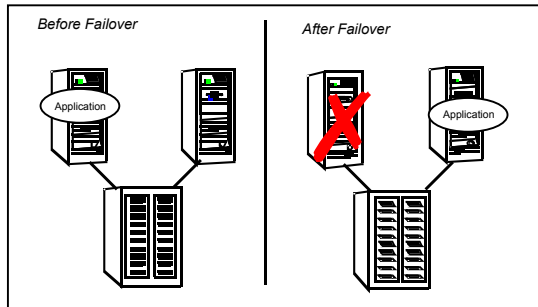

This configuration is the simplest and most reliable. The redundant server is on stand-by with full performance capability. If other applications are running, they present no compatibility issues.

Symmetric or active / active configuration

In a symmetric configuration, each server is configured to run a specific application or service and provide redundancy for its peer. In this example, each server runs one application service group. When a failure occurs, the surviving server hosts both application groups.

Figure 2-2 shows failover within a symmetric cluster configuration.

Figure 2-2 Symmetric failover

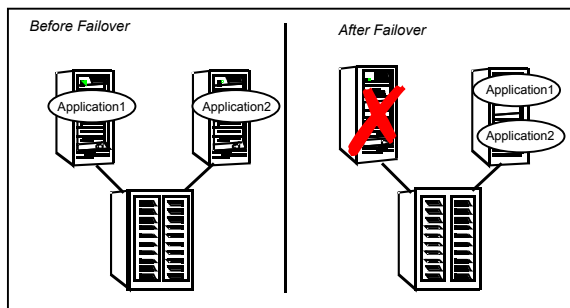

Symmetric configurations appear more efficient in terms of hardware utilization. In the asymmetric example, the redundant server requires only as much processor power as its peer. On failover, performance remains the same. In the symmetric example, the redundant server requires adequate processor power to run the existing application and the new application it takes over.

Further issues can arise in symmetric configurations when multiple applications that run on the same system do not co-exist properly. Some applications work well with multiple copies started on the same system, but others fail. Issues also can arise when two applications with different I/O and memory requirements run on the same system.

About N-to-1 configuration

An N-to-1 failover configuration reduces the cost of hardware redundancy and still provides a potential, dedicated spare. In an asymmetric configuration no performance penalty exists. No issues exist with multiple applications running on the same system; however, the drawback is the 100 percent redundancy cost at the server level.

Figure 2-3 shows an N to 1 failover configuration.

Figure 2-3 N-to-1 configuration

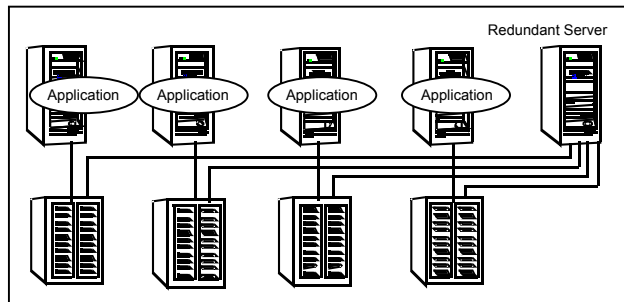

An N-to-1 configuration is based on the concept that multiple, simultaneous server failures are unlikely; therefore, a single redundant server can protect multiple active servers. When a server fails, its applications move to the redundant server. For example, in a 4-to-1 configuration, one server can protect four servers. This configuration reduces redundancy cost at the server level from 100 percent to 25 percent. In this configuration, a dedicated, redundant server is cabled to all storage and acts as a spare when a failure occurs.

The problem with this design is the issue of failback. When the failed server is repaired, you must manually fail back all services that are hosted on the failover server to the original server. The failback action frees the spare server and restores redundancy to the cluster.

Figure 2-4 shows an N to 1 failover requiring failback.

Figure 2-4 N-to-1 failover requiring failback

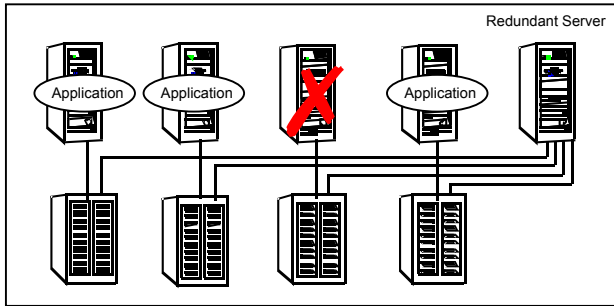

Most shortcomings of early N-to-1 cluster configurations are caused by the limitations of storage architecture. Typically, it is impossible to connect more than two hosts to a storage array without complex cabling schemes and their inherent reliability problems, or expensive arrays with multiple controller ports.

About advanced failover configurations

Advanced failover configuration for VCS include N + 1 and N-to-N configurations.

About the N + 1 configuration

With the capabilities introduced by storage area networks (SANs), you cannot only create larger clusters, you can also connect multiple servers to the same storage.

Figure 2-5 shows an N+1 cluster failover configuration.

Figure 2-5 N+1 configuration

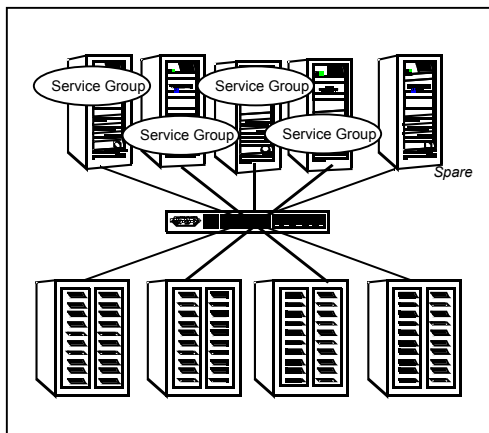

A dedicated, redundant server is no longer required in the configuration. Instead of N-to-1 configurations, you can use an N+1 configuration. In advanced N+1 configurations, an extra server in the cluster is spare capacity only.

When a server fails, the application service group restarts on the spare. After the server is repaired, it becomes the spare. This configuration eliminates the need for a second application failure to fail back the service group to the primary system. Any server can provide redundancy to any other server.

Figure 2-6 shows an N+1 cluster failover configuration requiring failback.

Figure 2-6 N+1 cluster failover configuration requiring failback

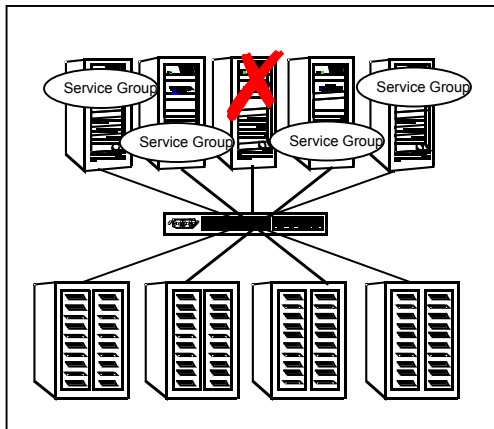

About the N-to-N configuration

An N-to-N configuration refers to multiple service groups that run on multiple servers, with each service group capable of being failed over to different servers. For example, consider a four-node cluster in which each node supports three critical database instances.

Figure 2-7 shows an N to N cluster failover configuration.

Figure 2-7 N-to-N configuration

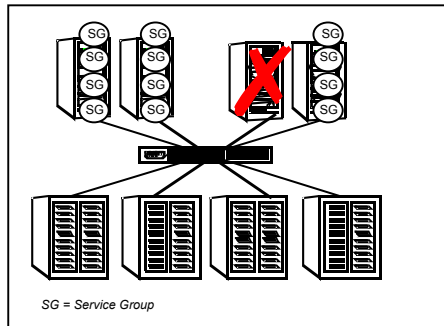

If any node fails, each instance is started on a different node. This action ensures that no single node becomes overloaded. This configuration is a logical evolution of N + 1; it provides cluster standby capacity instead of a standby server.

N-to-N configurations require careful testing to ensure that all applications are compatible. You must specify a list of systems on which a service group is allowed to run in the event of a failure.

Cluster topologies and storage configurations

The commonly-used cluster topologies include the following:

- Shared storage clusters
- Campus clusters
- Shared nothing clusters
- Replicated data clusters
- Global clusters

About basic shared storage cluster

In this configuration, a single cluster shares access to a storage device, typically over a SAN. You can only start an application on a node with access to the required storage. For example, in a multi-node cluster, any node that is designated to run a specific database instance must have access to the storage where the database's tablespaces, redo logs, and control files are stored. Such a shared disk architecture is also the easiest to implement and maintain. When a node or application fails, all data that is required to restart the application on another node is stored on the shared disk.

[Figure 2-8](#) shows a shared disk architecture for a basic cluster.

Figure 2-8 Shared disk architecture for basic cluster

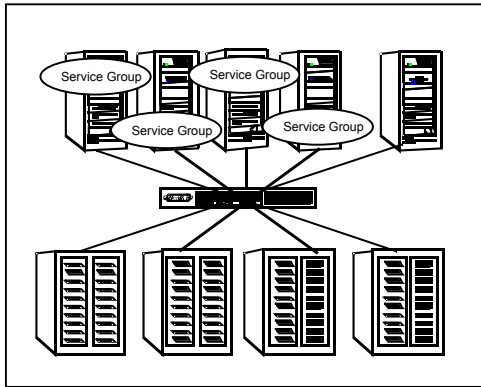

About campus, or metropolitan, shared storage cluster

In a campus environment, you use VCS and Veritas Volume Manager to create a cluster that spans multiple datacenters or buildings. Instead of a single storage array, data is mirrored between arrays by using Veritas Volume Manager. This configuration provides synchronized copies of data at both sites. This procedure is identical to mirroring between two arrays in a datacenter; only now it is spread over a distance.

Figure 2-9 shows a campus shared storage cluster.

Figure 2-9 Campus shared storage cluster

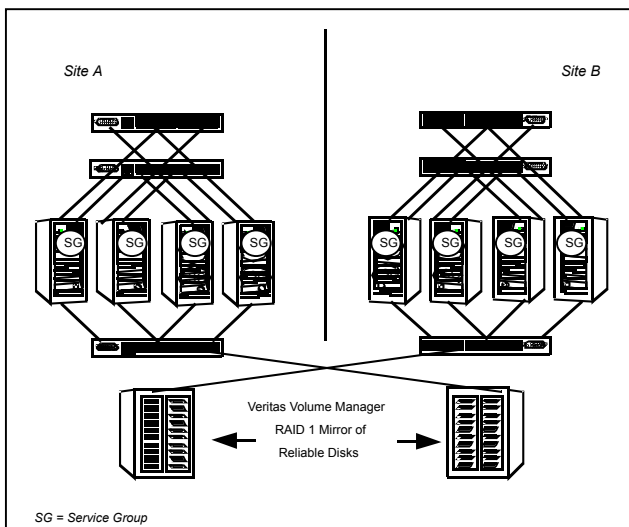

A campus cluster requires two independent network links for heartbeat, two storage arrays each providing highly available disks, and public network connectivity between buildings on same IP subnet. If the campus cluster setup resides on different subnets with one for each site, then use the VCS DNS agent to handle the network changes or issue the DNS changes manually.

See “[How VCS campus clusters work](#)” on page 639.

About shared nothing clusters

Systems in shared nothing clusters do not share access to disks; they maintain separate copies of data. VCS shared nothing clusters typically have read-only data stored locally on both systems. For example, a pair of systems in a cluster that includes a critical Web server, which provides access to a backend database. The Web server runs on local disks and does not require data sharing at the Web server level.

[Figure 2-10](#) shows a shared nothing cluster.

Figure 2-10 Shared nothing cluster

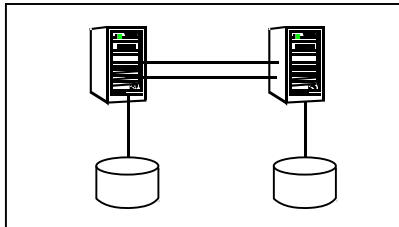

About replicated data clusters

In a replicated data cluster no shared disks exist. Instead, a data replication product synchronizes copies of data between nodes or sites. Replication can take place at the application, host, and storage levels. Application-level replication products, such as Oracle DataGuard, maintain consistent copies of data between systems at the SQL or database levels. Host-based replication products, such as Veritas Volume Replicator, maintain consistent storage at the logical volume level. Storage-based or array-based replication maintains consistent copies of data at the disk or RAID LUN level.

[Figure 2-11](#) shows a hybrid shared storage and replicated data cluster, in which different failover priorities are assigned to nodes according to particular service groups.

Figure 2-11 Shared storage replicated data cluster

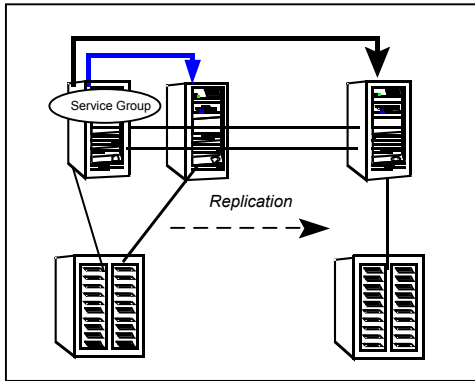

You can also configure replicated data clusters without the ability to fail over locally, but this configuration is not recommended.

See “[How VCS replicated data clusters work](#)” on page 630.

About global clusters

A global cluster links clusters at separate locations and enables wide-area failover and disaster recovery.

Local clustering provides local failover for each site or building. Campus and replicated cluster configurations offer protection against disasters that affect limited geographic regions. Large scale disasters such as major floods, hurricanes, and earthquakes can cause outages for an entire city or region. In such situations, you can ensure data availability by migrating applications to sites located considerable distances apart.

[Figure 2-12](#) shows a global cluster configuration.

Figure 2-12 Global cluster

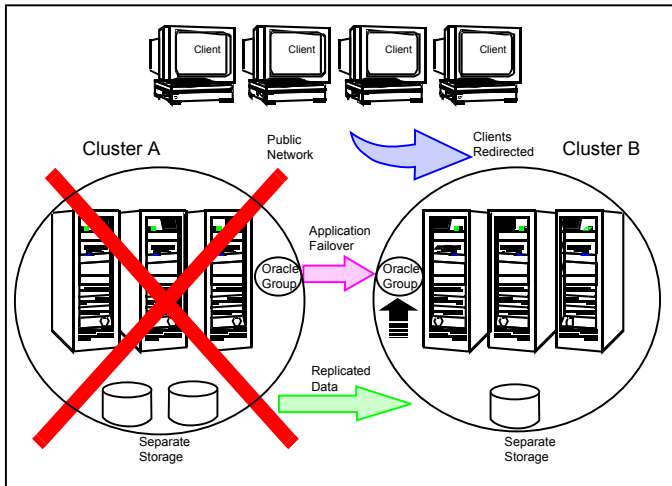

In a global cluster, if an application or a system fails, the application is migrated to another system within the same cluster. If the entire cluster fails, the application is migrated to a system in another cluster. Clustering on a global level also requires the replication of shared data to the remote site.

VCS configuration concepts

This chapter includes the following topics:

- [About configuring VCS](#)
- [VCS configuration language](#)
- [About the main.cf file](#)
- [About the types.cf file](#)
- [About VCS attributes](#)
- [VCS keywords and reserved words](#)
- [VCS environment variables](#)

About configuring VCS

When you configure VCS, you convey to the Veritas High Availability Engine the definitions of the cluster, service groups, resources, and dependencies among service groups and resources.

VCS uses the following two configuration files in a default configuration:

- `main.cf`
Defines the cluster, including services groups and resources.
- `types.cf`
Defines the resource types.

By default, both files reside in the following directory:

`/etc/VRTSvcs/conf/config`

Additional files that are similar to `types.cf` may be present if you enabled agents. `OracleTypes.cf`, by default, is located at `/etc/VRTSagents/ha/conf/Oracle/`.

In a VCS cluster, the first system to be brought online reads the configuration file and creates an internal (in-memory) representation of the configuration. Systems that are brought online after the first system derive their information from systems that are in the cluster.

You must stop the cluster if you need to modify the files manually. Changes made by editing the configuration files take effect when the cluster is restarted. The node where you made the changes should be the first node to be brought back online.

VCS configuration language

The VCS configuration language specifies the makeup of service groups and their associated entities, such as resource types, resources, and attributes. These specifications are expressed in configuration files, whose names contain the suffix `.cf`.

Several ways to generate configuration files are as follows:

- Use the Web-based Veritas InfoScale Operations Manager.
- Use Cluster Manager (Java Console).
- Use the command-line interface.
- If VCS is not running, use a text editor to create and modify the files.
- Use the VCS simulator on a Windows system to create the files.

About the `main.cf` file

The format of the `main.cf` file comprises include clauses and definitions for the cluster, systems, service groups, and resources. The `main.cf` file also includes service group and resource dependency clauses.

[Table 3-1](#) describes some of the components of the `main.cf` file:

Table 3-1 Components of the main.cf file

Components of main.cf file	Description
Include clauses	<p>Include clauses incorporate additional configuration files into main.cf. These additional files typically contain type definitions, including the types.cf file. Typically, custom agents add type definitions in their own files.</p> <pre data-bbox="700 496 932 522">include "types.cf"</pre> <p>See "Including multiple .cf files in main.cf" on page 67.</p>
Cluster definition	<p>Defines the attributes of the cluster, the cluster name and the names of the cluster users.</p> <pre data-bbox="700 682 1163 760">cluster demo (UserNames = { admin = cDRpdxPmHzpS })</pre> <p>See "Cluster attributes" on page 831.</p>
System definition	<p>Lists the systems designated as part of the cluster. The system names must match the name returned by the command <code>uname -a</code>.</p> <p>Each service group can be configured to run on a subset of systems defined in this section.</p> <pre data-bbox="700 1025 881 1072">system Server1 system Server2</pre> <p>See System attributes on page 816.</p>
Service group definition	<p>Service group definitions in main.cf comprise the attributes of a particular service group.</p> <pre data-bbox="686 1237 1228 1341">group NFS_group1 (SystemList = { Server1=0, Server2=1 } AutoStartList = { Server1 })</pre> <p>See "Service group attributes" on page 789.</p> <p>See "About the SystemList attribute" on page 66.</p>

Table 3-1 Components of the main.cf file (*continued*)

Components of main.cf file	Description
Resource definition	<p>Defines each resource that is used in a particular service group. You can add resources in any order. The utility hacfr arranges the resources alphabetically the first time the configuration file is run.</p> <pre>DiskGroup DG_shared1 (DiskGroup = shared1)</pre>
Resource dependency clause	<p>Defines a relationship between resources. A dependency is indicated by the keyword <code>requires</code> between two resource names.</p> <pre>IP_resource requires NIC_resource</pre> <p>In an <code>atleast</code> resource dependency, the parent resource depends on a set of child resources and a minimum number of resources from this resource set are required for the parent resource to be brought online or to remain online.</p> <pre>res1 requires atleast 2 from res2, res3, res4, res5, res6</pre> <p>The above dependency states that <code>res1</code> can be brought online or can remain online only when 2 resources from the resource set (<code>res2</code>, <code>res3</code>, <code>res4</code>, <code>res5</code>, <code>res6</code>) are online. The minimum number of resources required by the parent resource should be greater than or equal to 1 and less than the total number of child resources in the resource set.</p> <p>See “About resources and resource dependencies” on page 33.</p>
Service group dependency clause	<p>To configure a service group dependency, place the keyword <code>requires</code> in the service group declaration of the main.cf file. Position the dependency clause before the resource dependency specifications and after the resource declarations.</p> <pre>requires group_x <dependency category> <dependency location> <dependency rigidity></pre> <p>See “About service group dependencies” on page 475.</p>

Note: Sample configurations for components of global clusters are listed separately. See “[VCS global clusters: The building blocks](#)” on page 557.

About the SystemList attribute

The SystemList attribute designates all systems where a service group can come online. By default, the order of systems in the list defines the priority of systems that are used in a failover. For example, the following definition configures SystemA to be the first choice on failover, followed by SystemB, and then by SystemC.

```
SystemList = { SystemA, SystemB, SystemC }
```

You can assign system priority explicitly in the SystemList attribute by assigning numeric values to each system name. For example:

```
SystemList = { SystemA = 0, SystemB = 1, SystemC = 2 }
```

If you do not assign numeric priority values, VCS assigns a priority to the system without a number by adding 1 to the priority of the preceding system. For example, if the SystemList is defined as follows, VCS assigns the values SystemA = 0, SystemB = 2, SystemC = 3.

```
SystemList = { SystemA, SystemB = 2, SystemC }
```

Note that a duplicate numeric priority value may be assigned in some situations:

```
SystemList = { SystemA, SystemB=0, SystemC }
```

The numeric values assigned are SystemA = 0, SystemB = 0, SystemC = 1.

To avoid this situation, do not assign any numbers or assign different numbers to each system in SystemList.

Initial configuration

When VCS is installed, a basic main.cf configuration file is created with the cluster name, systems in the cluster, and a Cluster Manager user named *admin* with the password *password*.

The following is an example of the main.cf for cluster demo and systems SystemA and SystemB.

```
include "types.cf"
cluster demo (
UserNames = { admin = cDRpdxPmHzpS }
)
```

```
system SystemA (
)
system SystemB (
)
```

Including multiple .cf files in main.cf

You may choose include several configuration files in the main.cf file. For example:

```
include "applicationtypes.cf"
include "listofsystems.cf"
include "applicationgroup.cf"
```

If you include other .cf files in main.cf, the following considerations apply:

- Resource type definitions must appear before the definitions of any groups that use the resource types.

In the following example, the applicationgroup.cf file includes the service group definition for an application. The service group includes resources whose resource types are defined in the file applicationtypes.cf. In this situation, the applicationtypes.cf file must appear first in the main.cf file.

For example:

```
include "applicationtypes.cf"
include "applicationgroup.cf"
```

- If you define heartbeats outside of the main.cf file and include the heartbeat definition file, saving the main.cf file results in the heartbeat definitions getting added directly to the main.cf file.

About the types.cf file

The types.cf file describes standard resource types to the VCS engine; specifically, the data required to control a specific resource.

The types definition performs the following two important functions:

- Defines the type of values that may be set for each attribute.
In the following DiskGroup example, the NumThreads and OnlineRetryLimit attributes are both classified as int, or integer. The DiskGroup, StartVolumes and StopVolumes attributes are defined as str, or strings.
See [“About attribute data types”](#) on page 69.
- Defines the parameters that are passed to the VCS engine through the ArgList attribute. The line `static str ArgList[] = { xxx, yyy, zzz }` defines the order in which

parameters are passed to the agents for starting, stopping, and monitoring resources.

The following example illustrates a DiskGroup resource type definition for AIX:

```
type DiskGroup (
    static keylist SupportedActions = {
        "license.vfd", "disk.vfd", "udid.vfd",
        "verifyplex.vfd", checkudid, numdisks,
        campusplex, volinuse, joindg, splitdg,
        getvxvminfo }
    static int NumThreads = 1
    static int OnlineRetryLimit = 1
    static str ArgList[] = { DiskGroup,
        StartVolumes, StopVolumes, MonitorOnly,
        MonitorReservation, tempUseFence, PanicSystemOnDGLoss,
        UmountVolumes, Reservation }
    str DiskGroup
    boolean StartVolumes = 1
    boolean StopVolumes = 1
    boolean MonitorReservation = 0
    temp str tempUseFence = INVALID
    boolean PanicSystemOnDGLoss = 0
    int UmountVolumes
    str Reservation = ClusterDefault
)
```

For another example, review the following main.cf and types.cf files that represent an IP resource:

- The high-availability address is configured on the interface, which is defined by the Device attribute.
- The IP address is enclosed in double quotes because the string contains periods. See [“About attribute data types”](#) on page 69.
- The VCS engine passes the identical arguments to the IP agent for online, offline, clean, and monitor. It is up to the agent to use the arguments that it requires. All resource names must be unique in a VCS cluster.

main.cf for AIX:

```
IP nfs_ip1 (
    Device = en0
    Address = "192.168.1.201"
    Netmask = "255.255.255.0"
)
```

types.cf for AIX:

```
type IP (
    static keylist RegList = { NetMask }
    static keylist SupportedActions = { "device.vfd", "route.vfd" }
    static str ArgList[] = { Device, Address, NetMask, Options,
    RouteOptions, PrefixLen }
    static int ContainerOpts{} = { RunInContainer=0, PassCInfo=1 }
    str Device
    str Address
    str NetMask
    str Options
    str RouteOptions
    int PrefixLen
)
```

About VCS attributes

VCS components are configured by using attributes. Attributes contain data about the cluster, systems, service groups, resources, resource types, agent, and heartbeats if you use global clusters. For example, the value of a service group's SystemList attribute specifies on which systems the group is configured and the priority of each system within the group. Each attribute has a definition and a value. Attributes also have default values assigned when a value is not specified.

About attribute data types

VCS supports the following data types for attributes:

String	<p>A string is a sequence of characters that is enclosed by double quotes. A string can also contain double quotes, but the quotes must be immediately preceded by a backslash. A backslash is represented in a string as \\. Quotes are not required if a string begins with a letter, and contains only letters, numbers, dashes (-), and underscores (_).</p> <p>For example, a string that defines a network interface such as en0 does not require quotes since it contains only letters and numbers. However a string that defines an IP address contains periods and requires quotes—such as: "192.168.100.1".</p>
Integer	<p>Signed integer constants are a sequence of digits from 0 to 9. They may be preceded by a dash, and are interpreted in base 10. Integers cannot exceed the value of a 32-bit signed integer: 21471183247.</p>

Boolean A boolean is an integer, the possible values of which are 0 (false) and 1 (true).

About attribute dimensions

VCS attributes have the following dimensions:

Scalar A scalar has only one value. This is the default dimension.

Vector A vector is an ordered list of values. Each value is indexed by using a positive integer beginning with zero. Use a comma (,) or a semi-colon (;) to separate values. A set of brackets ([]) after the attribute name denotes that the dimension is a vector.

For example, an agent's ArgList is defined as:

```
static str ArgList[] = { RVG, DiskGroup }
```

Keylist A keylist is an unordered list of strings, and each string is unique within the list. Use a comma (,) or a semi-colon (;) to separate values.

For example, to designate the list of systems on which a service group will be started with VCS (usually at system boot):

```
AutoStartList = {SystemA; SystemB; SystemC}
```

Association An association is an unordered list of name-value pairs. Use a comma (,) or a semi-colon (;) to separate values.

A set of braces ({} after the attribute name denotes that an attribute is an association.

For example, to associate the average time and timestamp values with an attribute:

```
str MonitorTimeStats{} = { Avg = "0", TS = "" }
```

About attributes and cluster objects

VCS has the following types of attributes, depending on the cluster object the attribute applies to:

Cluster attributes Attributes that define the cluster.

For example, ClusterName and ClusterAddress.

Service group attributes	Attributes that define a service group in the cluster. For example, Administrators and ClusterList.
System attributes	Attributes that define the system in the cluster. For example, Capacity and Limits.
Resource type attributes	Attributes that define the resource types in VCS. These resource type attributes can be further classified as: <ul style="list-style-type: none">■ Type-independent Attributes that all agents (or resource types) understand. Examples: RestartLimit and MonitorInterval; these can be set for any resource type. Typically, these attributes are set for all resources of a specific type. For example, setting MonitorInterval for the IP resource type affects all IP resources.■ Type-dependent Attributes that apply to a particular resource type. These attributes appear in the type definition file (types.cf) for the agent. Example: The Address attribute applies only to the IP resource type. Attributes defined in the file types.cf apply to all resources of a particular resource type. Defining these attributes in the main.cf file overrides the values in the types.cf file for a specific resource. For example, if you set StartVolumes = 1 for the DiskGroup types.cf, it sets StartVolumes to True for all DiskGroup resources, by default. If you set the value in main.cf, it overrides the value on a per-resource basis.■ Static These attributes apply for every resource of a particular type. These attributes are prefixed with the term static and are not included in the resource's argument list. You can override some static attributes and assign them resource-specific values. See "Overriding resource type static attributes" on page 238.
Resource attributes	Attributes that define a specific resource. Some of these attributes are type-independent. For example, you can configure the Critical attribute for any resource. Some resource attributes are type-dependent. For example, the Address attribute defines the IP address that is associated with the IP resource. These attributes are defined in the main.cf file.
Site attributes	Attributes that define a site. For example, Preference and SystemList.

Attribute scope across systems: global and local attributes

An attribute whose value applies to all systems is global in scope. An attribute whose value applies on a per-system basis is local in scope. The at operator (@) indicates the system to which a local value applies.

An example of local attributes can be found in the following resource type where IP addresses and routing options are assigned per machine.

```
MultiNICA mnic (  
  Device@sys1 = { en0 = "166.98.16.103", en3 = "166.98.16.103" }  
  Device@sys2 = { en0 = "166.98.16.104", en3 = "166.98.16.104" }  
  NetMask = "255.255.255.0"  
  Options = "mtu m"  
  RouteOptions@sys1 = "-net 192.100.201.0 192.100.13.7"  
  RouteOptions@sys2 = "-net 192.100.201.1 192.100.13.8"  
)
```

About attribute life: temporary attributes

You can define temporary attributes in the types.cf file. The values of temporary attributes remain in memory as long as the VCS engine (HAD) is running. Values of temporary attributes are not available when HAD is restarted. These attribute values are not stored in the main.cf file.

You cannot convert temporary attributes to permanent attributes and vice-versa. When you save a configuration, VCS saves temporary attributes and their default values in the file types.cf.

The scope of these attributes can be local to a node or global across all nodes in the cluster. You can define local attributes even when the node is not part of a cluster.

You can define and modify these attributes only while VCS is running.

See [“Adding, deleting, and modifying resource attributes”](#) on page 223.

Size limitations for VCS objects

The following VCS objects are restricted to 1024 characters.

- Service group names
- Resource names
- Resource type names
- User names

- Attribute names

VCS passwords are restricted to 255 characters. You can enter a password of maximum 255 characters.

VCS keywords and reserved words

Following is a list of VCS keywords and reserved words. Note that they are case-sensitive.

action	firm	offline	set	system
after	global	online	Signaled	System
ArgListValues	group	MonitorOnly	site	temp
before	Group	Name	soft	type
boolean	hard	NameRule	start	Type
cluster	heartbeat	Path	Start	VCShm
Cluster	HostMonitor	Probed	state	VCShmg
condition	int	remote	State	
ConfidenceLevel	IState	remotecluster	static	
event	keylist	requires	stop	
false	local	resource	str	

VCS environment variables

[Table 3-2](#) lists VCS environment variables.

See “[Defining VCS environment variables](#)” on page 77.

See “[Environment variables to start and stop VCS modules](#)” on page 78.

Table 3-2 VCS environment variables

Environment Variable	Definition and Default Value
PERL5LIB	Root directory for Perl executables. (applicable only for Windows) Default: Install Drive:\Program Files\VERITAS\cluster server\lib\perl5.

Table 3-2 VCS environment variables (*continued*)

Environment Variable	Definition and Default Value
VCS_CONF	Root directory for VCS configuration files. Default: /etc/VRTSvcs Note: You cannot modify this variable.
VCS_CONN_INIT_QUOTA	Maximum number of simultaneous connections accepted by the VCS engine (HAD) per client host that has not completed the handshake.
VCS_CONN_HANDSHAKE_TIMEOUT	Timeout in seconds after which the VCS engine (HAD) closes the client connection that has not completed the handshake.
VCS_DEBUG_LOG_TAGS	Enables debug logs for the VCS engine, VCS agents, and HA commands. You must set VCS_DEBUG_LOG_TAGS before you start HAD or before you execute HA commands. See “Enabling debug logs for the VCS engine” on page 695. You can also export the variable from the /opt/VRTSvcs/bin/vcsenv file.
VCS_DOMAIN	The Security domain to which the VCS users belong. The VCS Authentication Service uses this environment variable to authenticate VCS users on a remote host. Default: Fully qualified host name of the remote host as defined in the VCS_HOST environment variable or in the .vcshost file.
VCS_DOMAINTYPE	The type of Security domain such as unixpwd, nt, nis, nisplus, ldap, or vx. The VCS Authentication Service uses this environment variable to authenticate VCS users on a remote host. Default: unixpwd
VCS_DIAG	Directory where VCS dumps HAD cores and FFDC data.
VCS_ENABLE_LDF	Designates whether or not log data files (LDFs) are generated. If set to 1, LDFs are generated. If set to 0, they are not.
VCS_HOME	Root directory for VCS executables. Default: /opt/VRTSvcs Note: You cannot modify this variable.
VCS_HOST	VCS node on which ha commands will be run.

Table 3-2 VCS environment variables (*continued*)

Environment Variable	Definition and Default Value
VCS_GAB_PORT	GAB port to which VCS connects. Default: h
VCS_GAB_TIMEOUT	Timeout in milliseconds for HAD to send heartbeats to GAB. Default: 30000 (denotes 30 seconds) Range: 30000 to 300000 (denotes 30 seconds to 300 seconds) If you set VCS_GAB_TIMEOUT to a value outside the range, the value is automatically reset to 30000 or 300000, depending on the proximity of the value to the lower limit or upper limit of the range. For example, the value is reset to 30000 if you specify 22000 and to 300000 if you specify 400000. Irrespective of the values set, VCS_GAB_TIMEOUT_SECS overrides VCS_GAB_TIMEOUT if both are specified. Note: If the specified timeout is exceeded, GAB kills HAD, and all active service groups on the system are disabled.
VCS_GAB_TIMEOUT_SECS	Timeout in seconds for HAD to send heartbeats to GAB under normal system load conditions. Default: 30 seconds Range: 30 seconds to 300 seconds If you set VCS_GAB_TIMEOUT_SECS to a value outside the range, the value is automatically reset to 30 or 300, depending on the proximity of the value to the lower limit or upper limit of the range. For example, the value is reset to 30 if you specify 22 and to 300 if you specify 400. Irrespective of the values set, VCS_GAB_TIMEOUT_SECS overrides VCS_GAB_TIMEOUT if both are specified. Note: If the specified timeout is exceeded, GAB kills HAD, and all active service groups on the system are disabled.

Table 3-2 VCS environment variables (*continued*)

Environment Variable	Definition and Default Value
VCS_GAB_PEAKLOAD_TIMEOUT_SECS	<p>Timeout in seconds for HAD to send heartbeats to GAB under peak system load conditions.</p> <p>Default: 30 seconds</p> <p>Range: 30 seconds to 300 seconds</p> <p>To set the GAB tunables in adaptive mode, you must set VCS_GAB_PEAKLOAD_TIMEOUT_SECS to a value that exceeds VCS_GAB_TIMEOUT_SECS. If you set VCS_GAB_PEAKLOAD_TIMEOUT_SECS to a value that is lower than VCS_GAB_TIMEOUT_SECS, it is reset to VCS_GAB_TIMEOUT_SECS.</p> <p>Note: If the specified timeout is exceeded, GAB kills HAD, and all active service groups on the system are disabled.</p>
VCS_GAB_RMTIMEOUT	<p>Timeout in milliseconds for HAD to register with GAB.</p> <p>Default: 200000 (denotes 200 seconds)</p> <p>If you set VCS_GAB_RMTIMEOUT to a value less than 200000, the value is automatically reset to 200000.</p> <p>See “About GAB client registration monitoring” on page 661.</p>
VCS_GAB_RMACTION	<p>Controls the GAB behavior when VCS_GAB_RMTIMEOUT exceeds.</p> <p>You can set the value as follows:</p> <ul style="list-style-type: none"> ■ panic—GAB panics the system ■ SYSLOG—GAB logs an appropriate message <p>Default: SYSLOG</p> <p>See “About GAB client registration monitoring” on page 661.</p>
VCS_HAD_RESTART_TIMEOUT	<p>Set this variable to designate the amount of time the hashadow process waits (sleep time) before restarting HAD.</p> <p>Default: 0</p>
VCS_LOG	<p>Root directory for log files and temporary files.</p> <p>You must not set this variable to "" (empty string).</p> <p>Default: /var/VRTSvcs</p> <p>Note: If this variable is added or modified, you must reboot the system to apply the changes.</p>

Table 3-2 VCS environment variables (*continued*)

Environment Variable	Definition and Default Value
VCS_SERVICE	<p>Name of the configured VCS service.</p> <p>The VCS engine uses this variable to determine the external communication port for VCS. By default, the external communication port for VCS is 14141.</p> <p>The value for this environment variable is defined in the service file at the following location:</p> <p>C:\Windows\System32\drivers\etc\services</p> <p>Default value: vcs</p> <p>If a new port number is not specified, the VCS engine starts with port 14141.</p> <p>To change the default port number, you must create a new entry in the service file at C:\Windows\System32\drivers\etc\services.</p> <p>For example, if you want the external communication port for VCS to be set to 14555, then you must create the following entries in the services file:</p> <pre>vcs 14555/tcp vcs 14555/udp</pre> <p>Note: The cluster-level attribute <code>OpenExternalCommunicationPort</code> determines whether the port is open or not.</p> <p>See “Cluster attributes” on page 831.</p>
VCS_TEMP_DIR	<p>Directory in which temporary information required by, or generated by, <code>hacf</code> is stored.</p> <p>Default: <code>/var/VRTSvcs</code></p> <p>This directory is created in the <code>tmp</code> directory under the following conditions:</p> <ul style="list-style-type: none"> ■ The variable is not set. ■ The variable is set but the directory to which it is set does not exist. ■ The <code>hacf</code> utility cannot find the default location.

Defining VCS environment variables

Create the `/opt/VRTSvcs/bin/custom_vcsenv` file and define VCS environment variables in that file. These variables are set for VCS when the `hastart` command is run.

To set a variable, use the syntax appropriate for the shell in which VCS starts. Typically, VCS starts in `/bin/sh`. For example, define the variables as:

```
VCS_GAB_TIMEOUT = 35000;export VCS_GAB_TIMEOUT
```

Environment variables to start and stop VCS modules

The start and stop environment variables for AMF, LLT, GAB, VxFEN, and VCS engine define the default VCS behavior to start these modules during system restart or stop these modules during system shutdown.

Note: The startup and shutdown of AMF, LLT, GAB, VxFEN, and VCS engine are inter-dependent. For a clean startup or shutdown of VCS, you must either enable or disable the startup and shutdown modes for all these modules.

In a single-node cluster, you can disable the start and stop environment variables for LLT, GAB, and VxFEN if you have not configured these kernel modules.

[Table 3-3](#) describes the start and stop variables for VCS.

Table 3-3 Start and stop environment variables for VCS

Environment variable	Definition and default value
AMF_START	Startup mode for the AMF driver. By default, the AMF driver is enabled to start up after a system reboot. This environment variable is defined in the following file: <code>/etc/default/amf</code> Default: 1
AMF_STOP	Shutdown mode for the AMF driver. By default, the AMF driver is enabled to stop during a system shutdown. This environment variable is defined in the following file: <code>/etc/default/amf</code> Default: 1
LLT_START	Startup mode for LLT. By default, LLT is enabled to start up after a system reboot. This environment variable is defined in the following file: <code>/etc/default/llt</code> Default: 1

Table 3-3 Start and stop environment variables for VCS (*continued*)

Environment variable	Definition and default value
LLT_STOP	<p>Shutdown mode for LLT. By default, LLT is enabled to stop during a system shutdown.</p> <p>This environment variable is defined in the following file:</p> <pre data-bbox="579 470 790 493">/etc/default/llt</pre> <p>Default: 1</p>
GAB_START	<p>Startup mode for GAB. By default, GAB is enabled to start up after a system reboot.</p> <p>This environment variable is defined in the following file:</p> <pre data-bbox="579 678 790 701">/etc/default/gab</pre> <p>Default: 1</p>
GAB_STOP	<p>Shutdown mode for GAB. By default, GAB is enabled to stop during a system shutdown.</p> <p>This environment variable is defined in the following file:</p> <pre data-bbox="579 887 790 909">/etc/default/gab</pre> <p>Default: 1</p>
VXFEN_START	<p>Startup mode for VxFEN. By default, VxFEN is enabled to start up after a system reboot.</p> <p>This environment variable is defined in the following file:</p> <pre data-bbox="579 1095 817 1117">/etc/default/vxfen</pre> <p>Default: 1</p>
VXFEN_STOP	<p>Shutdown mode for VxFEN. By default, VxFEN is enabled to stop during a system shutdown.</p> <p>This environment variable is defined in the following file:</p> <pre data-bbox="579 1303 817 1326">/etc/default/vxfen</pre> <p>Default: 1</p>
VCS_START	<p>Startup mode for VCS engine. By default, VCS engine is enabled to start up after a system reboot.</p> <p>This environment variable is defined in the following file:</p> <pre data-bbox="579 1512 790 1534">/etc/default/vcs</pre> <p>Default: 1</p>

Table 3-3 Start and stop environment variables for VCS (*continued*)

Environment variable	Definition and default value
VCS_STOP	<p>Shutdown mode for VCS engine. By default, VCS engine is enabled to stop during a system shutdown.</p> <p>This environment variable is defined in the following file:</p> <pre data-bbox="584 470 790 493">/etc/default/vcs</pre> <p>Default: 1</p>

Administration - Putting VCS to work

- [Chapter 4. About the VCS user privilege model](#)
- [Chapter 5. Administering the cluster from Cluster Manager \(Java console\)](#)
- [Chapter 6. Administering the cluster from the command line](#)
- [Chapter 7. Configuring applications and resources in VCS](#)
- [Chapter 8. Predicting VCS behavior using VCS Simulator](#)

About the VCS user privilege model

This chapter includes the following topics:

- [About VCS user privileges and roles](#)
- [How administrators assign roles to users](#)
- [User privileges for OS user groups for clusters running in secure mode](#)
- [VCS privileges for users with multiple roles](#)

About VCS user privileges and roles

Cluster operations are enabled or restricted depending on the privileges with which you log on. VCS has three privilege levels: Administrator, Operator, and Guest. VCS provides some predefined user roles; each role has specific privilege levels. For example, the role Guest has the fewest privileges and the role Cluster Administrator has the most privileges.

See [“About administration matrices”](#) on page 746.

VCS privilege levels

[Table 4-1](#) describes the VCS privilege categories.

Table 4-1 VCS privileges

VCS privilege levels	Privilege description
Administrators	Can perform all operations, including configuration

Table 4-1 VCS privileges (*continued*)

VCS privilege levels	Privilege description
Operators	Can perform specific operations on a cluster or a service group.
Guests	Can view specified objects.

User roles in VCS

[Table 4-2](#) lists the predefined VCS user roles, with a summary of their associated privileges.

Table 4-2 User role and privileges

User Role	Privileges
Cluster administrator	<p>Cluster administrators are assigned full privileges. They can make configuration read-write, create and delete groups, set group dependencies, add and delete systems, and add, modify, and delete users. All group and resource operations are allowed. Users with Cluster administrator privileges can also change other users' privileges and passwords.</p> <p>To stop a cluster, cluster administrators require administrative privileges on the local system.</p> <p>Note: Cluster administrators can change their own and other users' passwords only after they change the configuration to read or write mode.</p> <p>Cluster administrators can create and delete resource types.</p>
Cluster operator	<p>Cluster operators can perform all cluster-level, group-level, and resource-level operations, and can modify the user's own password and bring service groups online.</p> <p>Note: Cluster operators can change their own passwords only if configuration is in read or write mode. Cluster administrators can change the configuration to the read or write mode.</p> <p>Users with this role can be assigned group administrator privileges for specific service groups.</p>
Group administrator	<p>Group administrators can perform all service group operations on specific groups, such as bring groups and resources online, take them offline, and create or delete resources. Additionally, users can establish resource dependencies and freeze or unfreeze service groups. Note that group administrators cannot create or delete service groups.</p>

Table 4-2 User role and privileges (*continued*)

User Role	Privileges
Group operator	Group operators can bring service groups and resources online and take them offline. Users can also temporarily freeze or unfreeze service groups.
Cluster guest	Cluster guests have read-only access to the cluster, which means that they can view the configuration, but cannot change it. They can modify their own passwords only if the configuration is in read or write mode. They cannot add or update users. Additionally, users with this privilege can be assigned group administrator or group operator privileges for specific service groups. Note: By default, newly created users are assigned cluster guest permissions.
Group guest	Group guests have read-only access to the service group, which means that they can view the configuration, but cannot change it. The group guest role is available for clusters running in secure mode.

Hierarchy in VCS roles

Figure 4-1 shows the hierarchy in VCS and how the roles overlap with one another.

Figure 4-1 VCS roles

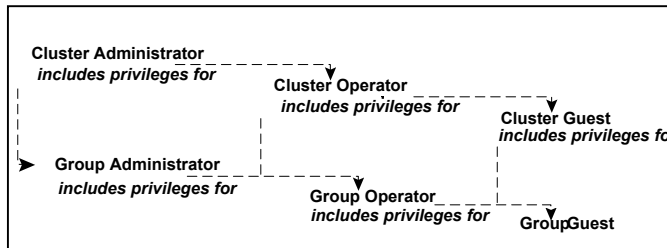

For example, cluster administrator includes privileges for group administrator, which includes privileges for group operator.

User privileges for CLI commands

Users logged with administrative or root privileges are granted privileges that exceed those of cluster administrator, such as the ability to start and stop a cluster.

If you do not have root privileges and the external communication port for VCS is not open, you cannot run CLI commands. If the port is open, VCS prompts for your VCS user name and password when you run *haxxx* commands.

You can use the `halogin` command to save the authentication information so that you do not have to enter your credentials every time you run a VCS command.

See [“Logging on to VCS”](#) on page 193.

See [“Cluster attributes”](#) on page 831.

User privileges for cross-cluster operations

A user or user group can perform a cross-cluster online or offline operation only if they have one of the following privileges on the remote cluster:

- Group administrator or group operator privileges for the group
- Cluster administrator or cluster operator privileges

A user or user group can perform a cross-cluster switch operation only if they have one of the following privileges on both the clusters:

- Group administrator or group operator privileges for the group
- Cluster administrator or cluster operator privileges

User privileges for clusters that run in secure mode

In secure mode, VCS assigns guest privileges to all native users.

When you assign privileges for clusters running in secure mode, you must specify fully-qualified user names, in the format `username@domain`.

When you assign privileges for clusters running in secure mode, you must specify user names in one of the following formats:

- To add a cluster-level user, specify only the user name.
- To add a node-level user, specify the user name in the `username@FQDN` format, where FQDN is the fully qualified domain name.

In a secure cluster, if the external communication port for VCS is not open, only root users logged on to the host system can run CLI commands.

See [“About managing VCS users from the command line”](#) on page 197.

See [“Cluster attributes”](#) on page 831.

You cannot assign or change passwords for users that use VCS when VCS runs in secure mode.

About the cluster-level user

You can add a cluster-level user by specifying the user name without the domain name. A cluster-level user can log in from any node in the cluster with the privilege that was assigned to the user. For example, if you add user1 to a cluster with four nodes (sys1, sys2, sys3, and sys4), user1 can access all four nodes with the privileges that were assigned at the cluster-level.

Adding users at the cluster-level offers the following advantages:

- Adding a cluster-level user requires only one entry per cluster. Adding a user at node level requires multiple entries, one for each node that the user is added to. To allow a user to operate from all four nodes in the cluster, you need four entries- user1@sys1, user1@sys2, user1@sys3, and user1@sys4, where sys1, sys2, sys3, and sys4 are fully qualified host names.
- Adding, updating, and deleting privileges at the cluster-level is easier and ensures uniformity of privileges for a user across nodes in a cluster.

How administrators assign roles to users

To assign a role to a user, an administrator performs the following tasks:

- Adds a user to the cluster, if the cluster is not running in secure mode.
- Assigns a role to the user.
- Assigns the user a set of objects appropriate for the role. For clusters that run in secure mode, you also can add a role to an operating system user group. See [“User privileges for OS user groups for clusters running in secure mode”](#) on page 87.

For example, an administrator may assign a user the group administrator role for specific service groups. Now, the user has privileges to perform operations on the specific service groups.

You can manage users and their privileges from the command line or from the graphical user interface.

See [“About managing VCS users from the command line”](#) on page 197.

See [“Administering user profiles”](#) on page 123.

User privileges for OS user groups for clusters running in secure mode

For clusters that run in secure mode, you can assign privileges to native users individually or at an operating system (OS) user group level.

For example, you may decide that all users that are part of the OS administrators group get administrative privileges to the cluster or to a specific service group. Assigning a VCS role to a user group assigns the same VCS privileges to all members of the user group, unless you specifically exclude individual users from those privileges.

When you add a user to an OS user group, the user inherits VCS privileges assigned to the user group.

Assigning VCS privileges to an OS user group involves adding the user group in one (or more) of the following attributes:

- AdministratorGroups—for a cluster or for a service group.
- OperatorGroups—for a cluster or for a service group.

For example, user Tom belongs to an OS user group: OSUserGroup1.

[Table 4-3](#) shows how to assign VCS privileges. FQDN denotes the fully qualified domain name in these examples.

Table 4-3 To assign user privileges

To assign privileges	At an individual level, configure attribute	To the OS user group, configure attribute
Cluster administrator	cluster (Administrators = {tom@FQDN})	cluster (AdministratorGroups = {OSUserGroup1@FQDN})
Cluster operator	cluster (Operators = {tom@FQDN})	cluster (OperatorGroups = {OSUserGroup1@FQDN})
Cluster guest	Cluster (Guests = {tom@FQDN})	Not applicable
Group administrator	group <i>group_name</i> (Administrators = {tom@FQDN})	group <i>group_name</i> (AdministratorGroups = {OSUserGroup1@FQDN})
Group operator	group <i>group_name</i> (Operators = {tom@FQDN})	group <i>group_name</i> (OperatorGroups = {OSUserGroup1@FQDN})
Group guest	Cluster (Guests = {tom@FQDN})	Not applicable

VCS privileges for users with multiple roles

Table 4-4 describes how VCS assigns privileges to users with multiple roles. The scenarios describe user Tom who is part of two OS user groups: OSUserGroup1 and OSUserGroup2.

Table 4-4 VCS privileges for users with multiple roles

Situation and rule	Roles assigned in the VCS configuration	Privileges that VCS grants Tom
<p>Situation: Multiple roles at an individual level.</p> <p>Rule: VCS grants highest privileges (or a union of all the privileges) to the user.</p>	<p>Tom: Cluster administrator</p> <p>Tom: Group operator</p>	<p>Cluster administrator.</p>
<p>Situation: Roles at an individual and OS user group level (secure clusters only).</p> <p>Rule: VCS gives precedence to the role granted at the individual level.</p>	<p>Tom: Group operator</p> <p>OSUserGroup1: Cluster administrator</p>	<p>Group operator</p>
<p>Situation: Different roles for different OS user groups (secure clusters only).</p> <p>Rule: VCS grants the highest privilege (or a union of all privileges of all user groups) to the user.</p>	<p>OSUserGroup1: Cluster administrators</p> <p>OSUserGroup2: Cluster operators</p>	<p>Cluster administrator</p>

Table 4-4 VCS privileges for users with multiple roles (*continued*)

Situation and rule	Roles assigned in the VCS configuration	Privileges that VCS grants Tom
<p>Situation: Roles at an individual and OS user group level (secure clusters only).</p> <p>Rule: VCS gives precedence to the role granted at the individual level.</p> <p>You can use this behavior to exclude specific users from inheriting VCS privileges assigned to their OS user groups.</p>	<p>OSUserGroup1: Cluster administrators</p> <p>OSUserGroup2: Cluster operators</p> <p>Tom: Group operator</p>	<p>Group operator</p>

Administering the cluster from Cluster Manager (Java console)

This chapter includes the following topics:

- [About the Cluster Manager \(Java Console\)](#)
- [Getting started prerequisites](#)
- [Components of the Java Console](#)
- [About Cluster Monitor](#)
- [About Cluster Explorer](#)
- [Accessing additional features of the Java Console](#)
- [Administering Cluster Monitor](#)
- [Administering user profiles](#)
- [Administering service groups](#)
- [Administering resources](#)
- [Administering systems](#)
- [Administering clusters](#)
- [Running commands](#)
- [Editing attributes](#)
- [Querying the cluster configuration](#)

- [Setting up VCS event notification by using the Notifier wizard](#)
- [Administering logs](#)
- [Administering VCS Simulator](#)

About the Cluster Manager (Java Console)

The Cluster Manager (Java Console) offers complete administration capabilities for your cluster. Use the different views in the Java Console to monitor clusters and VCS objects, including service groups, systems, resources, and resource types. Many of the operations that the Java Console supports are also supported by the command line interface and by Veritas InfoScale Operations Manager.

The console enables or disables features depending on whether the features are supported in the cluster that the console is connected to. For example, the Cluster Shell icon is not available when you connect to recent versions of VCS. But the icon is enabled when you connect to earlier versions of a VCS cluster.

You cannot manage new features introduced in releases 6.0 and later with Java Console.

You can download the Java Console from <https://www.veritas.com/product/storage-management/infoscale-operations-manager>.

Veritas recommends use of Veritas InfoScale Operations Manager to manage Storage Foundation and Cluster Server environments. Veritas InfoScale Operations Manager provides a centralized management console for Veritas InfoScale products. You can use Veritas InfoScale Operations Manager to monitor, visualize, and manage storage resources and generate reports. Veritas InfoScale Operations Manager is not available on the Storage Foundation and High Availability Solutions release and must be obtained separately. You can download this utility at no charge at <https://www.veritas.com/product/storage-management/infoscale-operations-manager>.

See “[Components for administering VCS](#)” on page 48.

About disability compliance

The cluster Manager (Java Console) for VCS provides disabled individuals access to and use of information and data that is comparable to the access and use provided to non-disabled individuals, including:

- Alternate keyboard sequences for specific operations.
See “[About accessibility in VCS](#)” on page 853.
- High-contrast display settings.

- Support of third-party accessibility tools. Note that Veritas has not tested screen readers for languages other than English.
- Text-only display of frequently viewed windows.

Getting started prerequisites

Following are the prerequisites for getting started with the Cluster Manager (Java Console):

- Make sure that you have the current version of Cluster Manager (Java Console) installed. If you have a previous version installed, upgrade to the latest version. Cluster Manager (Java Console) is compatible with earlier versions of VCS.
- Cluster Manager (Java Console) is supported on the following platforms:
 - AIX 6.1, and 7.1
 - HP-UX 11i v3 (IA-64 and PA-RISC)
 - RHEL5 U8 and RHEL6 U2
 - SLES10 SP4 and SLES11 SP2
 - Solaris 10 (SPARC and x86)
 - Windows XP, Windows Windows 7, Windows 8, Windows Server 2008 R2 SP1, Windows Server 2012, and Windows 2012 R2

If you configured Windows Firewall, add ports 14141 and 14150 to the Exceptions list.

By default, the external communication port for VCS is 14141. For Java Console to work, the external communication port for VCS must be open. You can close the external communication port for VCS by setting the cluster-level attribute `OpenExternalCommunicationPort`.

See [“Cluster attributes”](#) on page 831.

- Verify that the configuration has a user account. A user account is established during VCS installation that provides immediate access to Cluster Manager. If a user account does not exist, you must create one.
See [“Adding a user”](#) on page 124.
- On UNIX systems, you must set the display for Cluster Manager.
See [“Setting the display on UNIX systems”](#) on page 93.
- Start Cluster Manager.
See [“Starting Cluster Manager \(Java console\)”](#) on page 94.
- Add a cluster panel.
See [“Configuring a new cluster panel”](#) on page 120.

- Log on to a cluster.
See [“Logging on to a cluster and logging off”](#) on page 121.
- Make sure you have adequate privileges to perform cluster operations.
See [“About VCS user privileges and roles”](#) on page 82.

Setting the display on UNIX systems

The UNIX version of the Cluster Manager (Java Console) requires an X-Windows desktop. Setting the display is not required on Windows workstations.

To set the display on UNIX systems

- 1 Type the following command to grant the system permission to appear on the desktop:

```
# xhost +
```

- 2 Configure the shell environment variable DISPLAY on the system where Cluster Manager will be launched. For example, if you use Korn shell, type the following command to appear on the system myws:

```
# export DISPLAY=myws:0
```

Using Java Console with secure shell

You can use Java Console with secure shell (SSH) using X11 forwarding, or Port forwarding. Make sure that SSH is correctly configured on the client and the host systems.

In the Port forwarding mode, the console connects to a specified port on the client system. This port is forwarded to port 14141 on the VCS server node.

To use x11 forwarding

- 1 In the `ssh` configuration file, set `ForwardX11` to `yes`.

```
ForwardX11    yes
```

- 2 Log on to the remote system and start an X clock program that you can use to test the forward connection.

```
xclock &
```

Do not set the DISPLAY variable on the client. X connections forwarded through a secure shell use a special local display setting.

To use port forwarding

- 1 In the `ssh` configuration file, set `GatewayPorts` to `yes`.

```
GatewayPorts    yes
```

- 2 From the client system, forward a port (`client_port`) to port 14141 on the VCS server.

```
$ssh -L client_port:server_host:14141 server_host
```

You may not be able to set `GatewayPorts` in the configuration file if you use `openSSH`. In this case, use the `-g` option in the command.

```
$ssh -g -L client_port:server_host:14141 server_host
```

- 3 Open another window on the client system and start the Java Console.

```
$/opt/VRTSvcs/bin/hagui
```

- 4 Add a cluster panel in the Cluster Monitor. When prompted, enter the name of client system as the host and the `client_port` as the port. Do not enter `localhost`.

Starting Cluster Manager (Java console)

You can run the Java Console on Windows or UNIX systems.

To start the Java Console on Windows systems

- ◆ Click **Start > All Programs > Veritas > Veritas Cluster Server > Veritas Cluster Manager - Java Console**.

On Windows 2012 operating systems, use the **Apps** menu.

To start the Java Console on UNIX systems

- ◆ After you establish a user account and set up the display, type the following command to start Cluster Manager:

```
/opt/VRTSvcs/bin/hagui
```

The command `hagui` will not work across firewalls unless all outgoing server ports are open.

- VCS Engine: 14141
- Command server: 14150
- Secure cluster : 14149

Components of the Java Console

Cluster Manager (Java Console) offers two windows, Cluster Monitor and Cluster Explorer, from which most tasks are performed. Use Cluster Manager to manage, configure, and administer the cluster while VCS is running (online).

The Java Console also enables you to use VCS Simulator on Windows systems. Use this tool to simulate operations and generate new configuration files (main.cf and types.cf) while VCS is offline. VCS Simulator enables you to design configurations that imitate real-life scenarios without test clusters or changes to existing configurations.

See “[Administering VCS Simulator](#)” on page 172.

Icons in the Java Console

The Java Console uses several icons to communicate information about cluster objects and their states.

See “[Remote cluster states](#)” on page 758.

See “[System states](#)” on page 760.

[Table 5-1](#) shows the icons in the Cluster Manager (Java Console).

Table 5-1 Icons in Cluster Manager (Java Console)



















Icon	Description
	Cluster
	System
	Service Group
	Resource Type
	Resource
	OFFLINE

Table 5-1 Icons in Cluster Manager (Java Console) (*continued*)

Icon	Description
	Faulted (in UP BUT NOT IN CLUSTER MEMBERSHIP state)
	Faulted (in EXITED state)
	PARTIAL
	Link Heartbeats (in UP and DOWN states)
	UP AND IN JEOPARDY
	FROZEN
	AUTODISABLED
	UNKNOWN
	ADMIN_WAIT
	Global Service Group (requires the VCS Global Cluster Option)
	Remote Cluster in RUNNING state (requires the VCS Global Cluster Option)
	Remote Cluster in EXITING, EXITED, INIT, INQUIRY, LOST_CONN, LOST_HB, TRANSITIONING, or UNKNOWN state.

About Cluster Monitor

After you start Cluster Manager, the first window that appears is Cluster Monitor. This window includes one or more panels that display general information about actual or simulated clusters.

You can use Cluster Monitor to perform the following tasks:

- Log on to a cluster.
- Log off a cluster.
- View summary information on various VCS objects.
- Customize the display.
- Use VCS Simulator.
- Exit Cluster Manager.

Figure 5-1 shows the first window of the Veritas Cluster Manager.

Figure 5-1 Starting the Cluster Server Cluster Manager

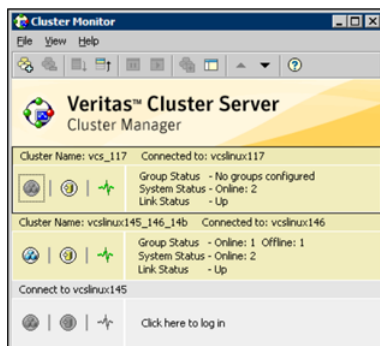

Cluster monitor toolbar

The Cluster Monitor toolbar contains several buttons.











Figure 5-2 shows the Cluster Monitor toolbar.

Figure 5-2 The Cluster Monitor toolbar



Table 5-2 lists the buttons from left to right as it appears on the Cluster monitor toolbar.

Table 5-2 Cluster monitor toolbar buttons

Button	Description
	New cluster: Adds a new cluster panel to Cluster Monitor
	Delete cluster: Removes a cluster panel from Cluster Monitor
	Expand: Expands the Cluster Monitor view
	Collapse: Pauses cluster panel scrolling
	Start: Resumes scrolling
	Stop: Pauses cluster panel scrolling
	Login: Log on to the cluster shown in the cluster panel
	Show Explorer: Launches an additional window of Cluster Explorer after logging on to that cluster
	Move Cluster Panel Up: Moves the selected cluster panel up
	Move Cluster Panel Down: Moves the selected cluster panel down
	Help: Access online help

About cluster monitor panels

To administer a cluster, add a cluster panel or reconfigure an existing cluster panel in Cluster Monitor. Each panel summarizes the status of the connection and components of a cluster.

Status of the cluster connection with Cluster Monitor

The right pane of a panel in Cluster Monitor displays the status of the connection to a cluster. An inactive panel appears unavailable until the user logs on and connects to the cluster. To alter the connection to a cluster, right-click a panel to access a menu.

Following menus are available:

- The menu on an active panel enables you to log off a cluster.
- The menu on an inactive panel enables you to log on to a cluster, configure the cluster, and delete the cluster from Cluster Monitor.

Menus are enabled when the Cluster Monitor display appears in the default expanded view. If you activate a menu on a collapsed scrolling view of Cluster Monitor, the scrolling stops while it accesses the menu.

If the system to which the console is connected goes down, a message notifies you that the connection to the cluster is lost. Cluster Monitor tries to connect to another system in the cluster according to the number of failover retries set in the Connectivity Configuration dialog box. The panels flash until Cluster Monitor is successfully connected to a different system. If the failover is unsuccessful, a message notifies you of the failure and the panels becomes unavailable

Monitoring VCS objects with Cluster Monitor

Cluster Monitor summarizes the state of various objects in a cluster and provides access to in-depth information about these objects in Cluster Explorer. The right pane of a Cluster Monitor panel displays the connection status (online, offline, up, or down) of service groups, systems, and heartbeats. The left pane of a Cluster Monitor panel displays three icons representing service groups, systems, and heartbeats.

The colors of the icons indicate the state of the cluster:

- A flashing red slash indicates that the Cluster Manager failed to connect to the cluster and will attempt to connect to another system in the cluster.
- A flashing yellow slash indicates that the Cluster Manager is experiencing problems with the connection to the cluster.

Point to an icon to access the icon's ScreenTip, which provides additional information on the specific VCS object.

To review detailed information about VCS objects in Cluster Explorer, Logs, and Command Center, right-click a panel to access a menu. Menus are enabled when the Cluster Monitor display appears in the default expanded view. If you activate a

menu on a collapsed, scrolling view of Cluster Monitor, the scrolling stops while it accesses the menu.

Expanding and collapsing the Cluster Monitor display

Cluster Monitor supports two views: expanded (default) and collapsed. The expanded view shows all cluster panels. The collapsed view shows one cluster panel at a time as the panels scroll upward.

Operations enabled for the expanded view of cluster panels, such as viewing menus, are also enabled on the collapsed view after the panels stop scrolling.

Review the action that you must perform for the following operations:

To collapse the Cluster Monitor view	On the View menu, click Collapse . or Click Collapse on the Cluster Monitor toolbar.
To expand the Cluster Monitor view	On the View menu, click Expand . or Click Expand on the Cluster Monitor toolbar.
To pause a scrolling cluster panel	Click the cluster panel. or Click Stop on the Cluster Monitor toolbar.

Customizing the Cluster Manager display

Customize the Cluster Manager to display objects according to your preference.

To customize the Cluster Manager display

- 1 From Cluster Monitor, click **Preferences** on the **File** menu. If you use a Windows system, proceed to step 2. Otherwise, proceed to step 3.
- 2 In the **Look & Feel** tab (for Windows systems), do the following:

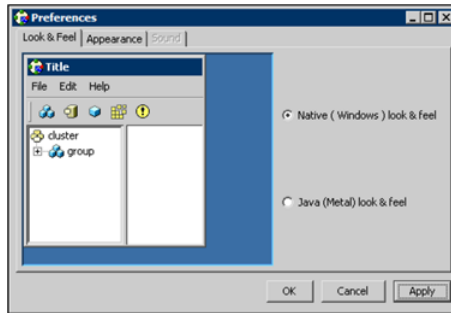

- Click **Native(Windows or Motif) look & feel** or **Java (Metal) look & feel**.
- Click **Apply**.

3 In the **Appearance** tab, do the following:

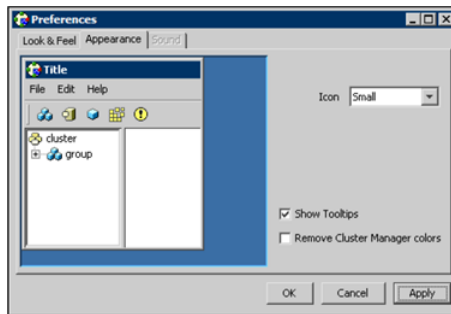

- Click the color (applies to Java (Metal) look & feel).
- Click an icon size.
- Select the **Show Tooltips** check box to enable ToolTips.
- Select the **Remove Cluster Manager colors** check box to alter the standard color scheme.
- Click **Apply**.

4 In the **Sound** tab, do the following:

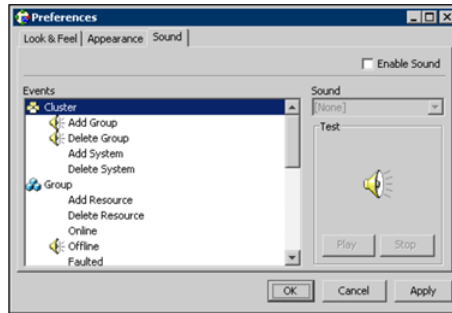

This tab requires a properly configured sound card.

- Select the **Enable Sound** check box to associate sound with specific events.
- Click an event from the **Events** configuration tree.
- Click a sound from the **Sounds** list box.
- To test the selected sound, click **Play**.
- Click **Apply**.
- Repeat these steps to enable sound for other events.

5 After you make your final selection, click **OK**.

About Cluster Explorer

Cluster Explorer is the main window for cluster administration. From this window, you can view the status of VCS objects and perform various operations.

[Figure 5-3](#) shows the Cluster explorer window.

Figure 5-3 Cluster Explorer window

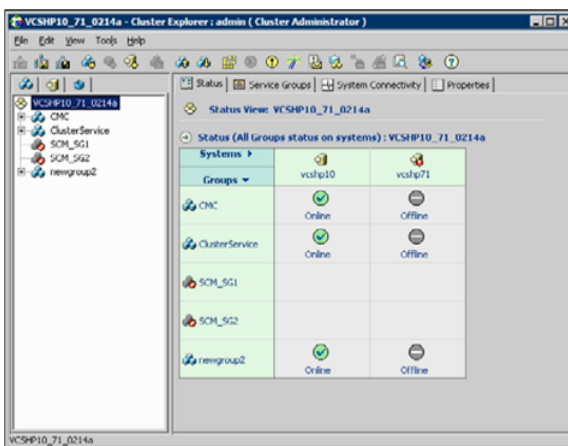

The window is divided into three panes. The top pane includes a toolbar that enables you to quickly perform frequently used operations. The left pane contains a configuration tree with three tabs: Service Groups, Systems, and Resource Types. The right pane contains a panel that displays various views relevant to the object selected in the configuration tree.

To access Cluster Explorer

- 1 Log on to the cluster.
 - 2 Click anywhere in the active Cluster Monitor panel.
- or
- Right-click the selected Cluster Monitor panel and click Explorer View from the menu.

Cluster Explorer toolbar

The Cluster Explorer toolbar contains 18 buttons.

Note: Some buttons may be disabled depending on the type of cluster (local or global) and the privileges with which you logged on to the cluster.

Figure 5-4 show the Cluster explorer toolbar.

Figure 5-4 Cluster Explorer toolbar



Table 5-3 shows the buttons on the Cluster Explorer toolbar.

left to right:

Table 5-3 Buttons on the Cluster explorer toolbar





















Button	Description
	Open Configuration. Modifies a read-only configuration to a read-write file. This enables you to modify the configuration.
	Save Configuration. Writes the configuration to disk.
	Save and Close Configuration. Writes the configuration to disk as a read-only file.
	Add Service Group. Displays the Add Service Group dialog box.
	Add Resource. Displays the Add Resource dialog box.
	Add System. Displays the Add System dialog box.
	Manage systems for a Service Group. Displays the System Manager dialog box.
	Online Service Group. Displays the Online Service Group dialog box.
	Offline Service Group. Displays the Offline Service Group dialog box.
	Show Command Center. Enables you to perform many of the same VCS operations available from the command line.
	Show Shell Command Window. Enables you to launch a non-interactive shell command on cluster systems, and to view the results on a per-system basis.
	Show the Logs. Displays alerts and messages that the VCS engine generates, VCS agents, and commands issued from the console.

Table 5-3 Buttons on the Cluster explorer toolbar (*continued*)

Button	Description
	Launch Configuration Wizard. Enables you to create VCS service groups.
	Launch Notifier Resource Configuration Wizard. Enables you to set up VCS event notification.
	Remote Group Resource Configuration Wizard. Enables you to configure resources to monitor a service group in a remote cluster.
	Add/Delete Remote Clusters. Enables you to add and remove global clusters.
	Configure Global Groups. Enables you to convert a local service group to a global group, and vice versa.
	Query. Enables you to search the cluster configuration according to filter criteria.
	Virtual Fire Drill. Checks whether a resource can fail over to another node in the cluster. Requires agents that support the running of virtual fire drills.
	Show Cluster Explorer Help. Enables you to access online help.

Cluster Explorer configuration tree

The Cluster Explorer configuration tree is a tabbed display of VCS objects.

The tabs are as follows:

- The **Service Groups** tab lists the service groups in the cluster. Expand each service group to view the group's resource types and resources.
- The **Systems** tab lists the systems in the cluster.
- The **Types** tab lists the resource types in the cluster

Cluster Explorer view panel

The right pane of the Cluster Explorer includes a view panel that provides detailed information about the object selected in the configuration tree. The information is presented in tabular or graphical format. Use the tabs in the view panel to access

a particular view. The console enables you to "tear off" each view to appear in a separate window.

- Click any object in the configuration tree to access the Status View and Properties View.
- Click a cluster in the configuration tree to access the Service Group view, the System Connectivity view, and the Remote Cluster Status View (for global clusters only).
- Click a service group in the configuration tree to access the Resource view.

To create a tear-off view

On the **View** menu, click **Tear Off**, and click the appropriate view from the menu.

or

Right-click the object in the configuration tree, click **View**, and click the appropriate view from the menu.

Status view

The Status View summarizes the state of the object selected in the configuration tree. Use this view to monitor the overall status of a cluster, system, service group, resource type, and resource.

For example, if a service group is selected in the configuration tree, the Status View displays the state of the service group and its resources on member systems. It also displays the last five critical or error logs. Point to an icon in the status table to open a ScreenTip about the relevant VCS object.

[Figure 5-5](#) shows the status view.

Figure 5-5 Status view

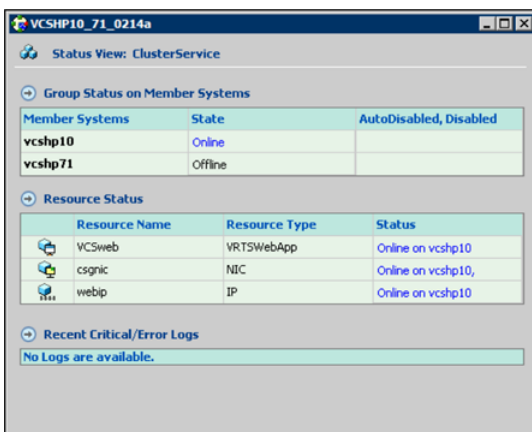

For global clusters, this view displays the state of the remote clusters. For global groups, this view shows the status of the groups on both local and remote clusters.

To access the Status view

- 1 From Cluster Explorer, click an object in the configuration tree.
- 2 In the view panel, click the **Status** tab.

Properties view

The Properties View displays the attributes of VCS objects. These attributes describe the scope and parameters of a cluster and its components.

Figure 5-6 shows the Properties view.

Figure 5-6 Properties view



To view information on an attribute, click the attribute name or the icon in the **Help** column of the table.

See [“About VCS attributes”](#) on page 69.

By default, this view displays key attributes of the object selected in the configuration tree. The Properties View for a resource displays key attributes of the resource and attributes specific to the resource types. It also displays attributes whose values have been overridden.

See [“Overriding resource type static attributes”](#) on page 151.

To view all attributes associated with the selected VCS object, click **Show all attributes**.

To access the properties view

- 1 From Cluster Explorer, click a VCS object in the configuration tree.
- 2 In the view panel, click the **Properties** tab.

Service Group view

The Service Group view displays the service groups and their dependencies in a cluster. Use the graph and ScreenTips in this view to monitor, create, and disconnect dependencies. To view the ScreenTips, point to a group icon for information on the type and state of the group on the cluster systems, and the type of dependency between the service groups.

Figure 5-7 shows the Service Group view.

Figure 5-7 Service Group view

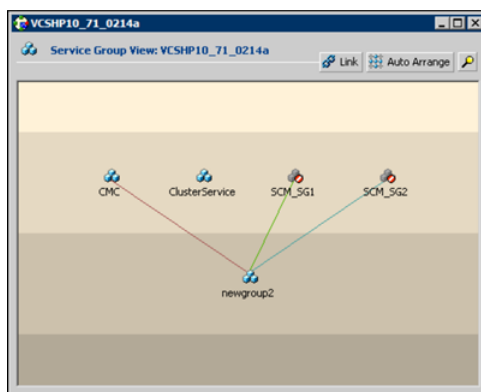

The line between two service groups represents a dependency, or parent-child relationship. In VCS, parent service groups depend on child service groups. A service group can function as a parent and a child.

See “[About service group dependencies](#)” on page 475.

The color of the link between service groups indicates different types of dependencies.

- A blue link indicates a soft dependency.
- A red link indicates a firm dependency.
- A green link indicates a hard dependency typically used with VVR in disaster recovery configurations.

To access the Service Group view

- 1 From Cluster Explorer, click a cluster in the configuration tree.
- 2 In the view panel, click the **Service Groups** tab.

Resource view

The Resource view displays the resources in a service group. Use the graph and ScreenTips in this view to monitor the dependencies between resources and the status of the service group on all or individual systems in a cluster.

Figure 5-8 shows the Resource view.

Figure 5-8 Resource view

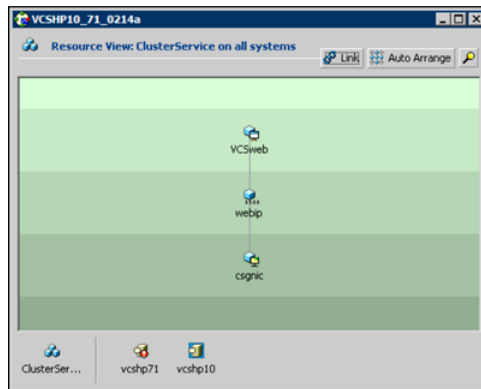

In the graph, the line between two resources represents a dependency, or parent-child relationship. Resource dependencies specify the order in which resources are brought online and taken offline. During a failover process, the resources closest to the top of the graph must be taken offline before the resources linked to them are taken offline. Similarly, the resources that appear closest to the bottom of the graph must be brought online before the resources linked to them can come online.

- A resource that depends on other resources is a parent resource. The graph links a parent resource icon to a child resource icon below it. Root resources (resources without parents) are displayed in the top row.
- A resource on which the other resources depend is a child resource. The graph links a child resource icon to a parent resource icon above it.
- A resource can function as a parent and a child.

Point to a resource icon to display ScreenTips about the type, state, and key attributes of the resource. The state of the resource reflects the state on a specified system (local).

In the bottom pane of the Resource view, point to the system and service group icons to display ScreenTips about the service group status on all or individual systems in a cluster. Click a system icon to view the resource graph of the service

group on the system. Click the service group icon to view the resource graph on all systems in the cluster.

To access the Resource view

- 1 From Cluster Explorer, click the service groups tab in the configuration tree.
- 2 Click a service group in the configuration tree.
- 3 In the view panel, click the **Resources** tab.

Moving and linking icons in Service Group and Resource views

Figure 5-9 shows the Link and Auto Arrange buttons that are available in the top right corner of the Service Group or Resource view.

Figure 5-9 The Link and Auto Arrange buttons

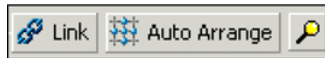

Click **Link** to set or disable the link mode for the Service Group and Resource views.

Note: There are alternative ways to set up dependency links without using the Link button.

The link mode enables you to create a dependency link by clicking on the parent icon, dragging the yellow line to the icon that will serve as the child, and then clicking the child icon. Use the Esc key to delete the yellow dependency line connecting the parent and child during the process of linking the two icons.

If the Link mode is not activated, click and drag an icon along a horizontal plane to move the icon. Click **Auto Arrange** to reset the appearance of the graph. The view resets the arrangement of icons after the addition or deletion of a resource, service group, or dependency link. Changes in the Resource and Service Group views will be maintained after the user logs off and logs on to the Java Console at a later time.

Zooming in on Service Group and Resource views

The Resource view and Service Group view include a navigator tool to zoom in or out of their graphs.

Figure 5-10 shows the magnifying glass icon in the top right corner to open the zoom panel.

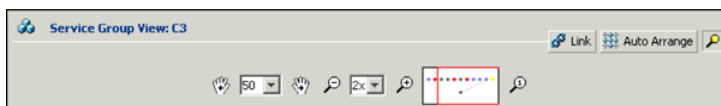
Figure 5-10 Zoom panel

- To move the view to the left or right, click a distance (in pixels) from the drop-down list box between the hand icons. Click the <- or -> hand icon to move the view in the desired direction.
- To shrink or enlarge the view, click a size factor from the drop-down list box between the magnifying glass icons. Click the - or + magnifying glass icon to modify the size of the view.
- To view a segment of the graph, point to the box to the right of the + magnifying glass icon. Use the red outline in this box to encompass the appropriate segment of the graph. Click the newly outlined area to view the segment.
- To return to the original view, click the magnifying glass icon labeled 1.

System Connectivity view

[Figure 5-11](#) shows the System Connectivity view that displays the status of system connections in a cluster. Use this view to monitor the system links and heartbeats.

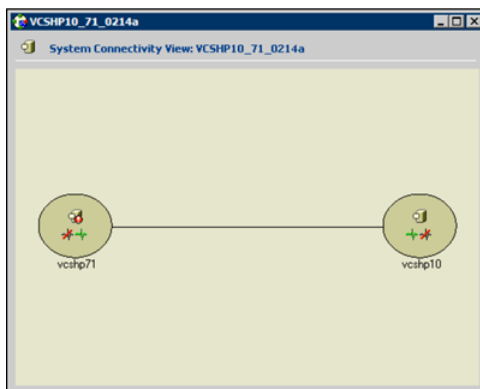
Figure 5-11 The System Connectivity view

VCS monitors systems and their services over a private network. The systems communicate via heartbeats over an additional private network, which enables them to recognize which systems are active members of the cluster, which are joining or leaving the cluster, and which have failed.

VCS protects against network failure by requiring that all systems be connected by two or more communication channels. When a system is down to a single heartbeat connection, VCS can no longer differentiate between the loss of a system and the loss of a network connection. This situation is referred to as jeopardy.

Point to a system icon to display a ScreenTip on the links and heartbeats. If a system in the cluster is experiencing a problem connecting to other systems, the system icon changes its appearance to indicate the link is down. In this situation, a jeopardy warning may appear in the ScreenTip for this system.

To access the System Connectivity view

- 1 From Cluster Explorer, click a cluster in the configuration tree.
- 2 In the view panel, click the **System Connectivity** tab.

Remote Cluster Status view

This view requires the VCS Global Cluster Option.

Figure 5-12 shows the Remote Cluster Status View that provides an overview of the clusters and global groups in a global cluster environment. Use this view to view the name, address, and status of a cluster, and the type (Icmp or IcmpS) and state of a heartbeat.

Figure 5-12 Remote Cluster Status View

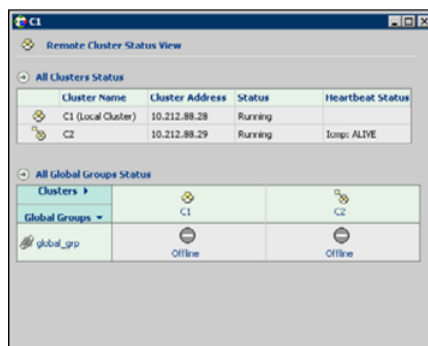

This view enables you to declare a remote cluster fault as a disaster, disconnect, or outage. Point to a table cell to view information about the VCS object.

To access the Remote Cluster Status view

- 1 From Cluster Explorer, click a cluster in the configuration tree.
- 2 In the view panel, click the **Remote Cluster Status** tab.

Accessing additional features of the Java Console

Use Cluster Manager to access the Template View, System Manager, User Manager, Command Center, Configuration Wizard, Notifier Resource Configuration Wizard, Remote Group Resource Configuration Wizard, Query Module, and Logs.

You can also use the Cluster Manager to run virtual fire drills (or HA fire drills) to check for any configurational discrepancies that might prevent a service group from coming online on a specific node.

Template view

The Template View displays the service group templates available in VCS. Templates are predefined service groups that define the resources, resource attributes, and dependencies within the service group. Use this view to add service groups to the cluster configuration, and copy the resources within a service group template to existing service groups.

In this window, the left pane displays the templates available on the system to which Cluster Manager is connected. The right pane displays the selected template's resource dependency graph.

Template files conform to the VCS configuration language and contain the extension .tf. These files reside in the VCS configuration directory.

Figure 5-13 shows the Template view.

Figure 5-13 Template view

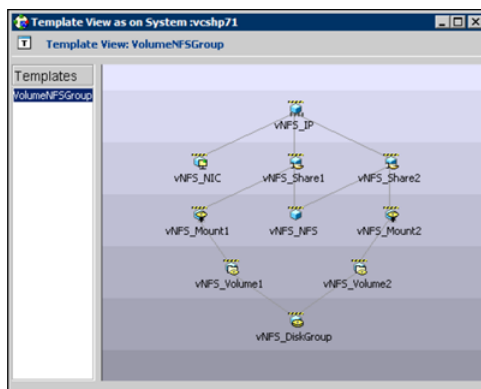

To access the template view

From Cluster Explorer, click **Templates** on the **Tools** menu.

System Manager

Use System Manager to add and remove systems in a service group's system list. A priority number (starting with 0) is assigned to indicate the order of systems on which the service group will start in case of a failover. If necessary, double-click the entry in the **Priority** column to enter a new value. Select the **Startup** check box to add the systems to the service groups AutoStartList attribute. This enables the service group to automatically come online on a system every time HAD is started.

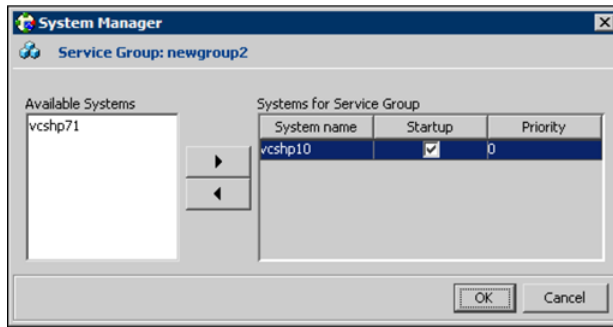

To access system Manager

From Cluster Explorer, click the service group in the configuration tree, and click **System Manager** on the **Tools** menu.

or

In the **Service Groups** tab of the Cluster Explorer configuration tree, click a service group, and click **Manage systems for a Service Group** on the toolbar.

User Manager

User Manager enables you to add and delete user profiles and to change user privileges. If VCS is not running in secure mode, User Manager enables you to change user passwords. You must be logged in as Cluster Administrator to access User Manager.

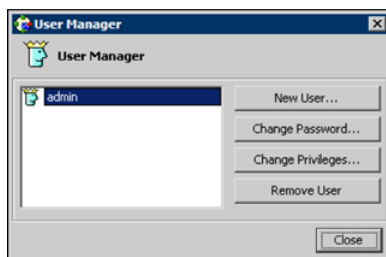

To access user Manager

From Cluster Explorer, click **User Manager** on the **File** menu.

Command Center

Command Center enables you to build and execute VCS commands; most commands that are executed from the command line can also be executed through this window. The left pane of the window displays a **Commands** tree of all VCS operations. The right pane displays a view panel that describes the selected command. The bottom pane displays the commands being executed.

The commands tree is organized into **Configuration** and **Operations** folders. Click the icon to the left of the **Configuration** or **Operations** folder to view its subfolders and command information in the right pane. Point to an entry in the commands tree to display information about the selected command.

[Figure 5-14](#) shows the Command center window.

Figure 5-14 Command center window

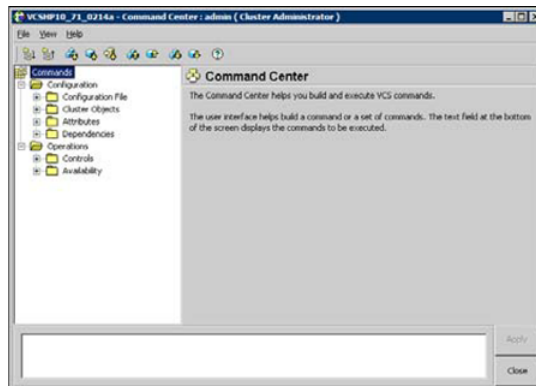

To access Command Center

From Cluster Explorer, click **Command Center** on the **Tools** menu.

or

On the Cluster Explorer toolbar, click **Show Command Center**.

Configuration wizard

Use Configuration Wizard to create and assign service groups to systems in a cluster.

See [“Creating service groups with the configuration wizard”](#) on page 141.

To access Configuration Wizard

From Cluster Explorer, click **Configuration Wizard** on the **Tools** menu.

or

On the Cluster Explorer toolbar, click **Launch Configuration Wizard**.

Notifier Resource Configuration wizard

VCS provides a method for notifying an administrator of important events such as a resource or system fault. VCS includes a "notifier" component, which consists of the notifier daemon and the hanotify utility. This wizard enables you to configure the notifier component as a resource of type NotifierMngr as part of the ClusterService group.

See [“Setting up VCS event notification by using the Notifier wizard”](#) on page 165.

To access Notifier Resource Configuration Wizard

From Cluster Explorer, click **Notifier Wizard** on the **Tools** menu.

or

On the Cluster Explorer toolbar, click **Launch Notifier Resource Configuration Wizard**.

Remote Group Resource Configuration Wizard

A RemoteGroup resource enables you to manage or monitor remote service groups from a local cluster. For each service group running in a remote cluster, you can create a corresponding RemoteGroup resource in the local cluster.

See [“Adding a RemoteGroup resource from the Java Console”](#) on page 146.

To access Remote Group Resource Configuration Wizard

From Cluster Explorer, click **Remote Group Resource Wizard...** on the **Tools** menu.

or

On the Cluster Explorer toolbar, click **Configure Remote Group Resource Wizard**.

Cluster query

Use Cluster Query to run SQL-like queries from Cluster Explorer. VCS objects that can be queried include service groups, systems, resources, and resource types. Some queries can be customized, including searching for the system's online group count and specific resource attributes.

See “[Querying the cluster configuration](#)” on page 164.

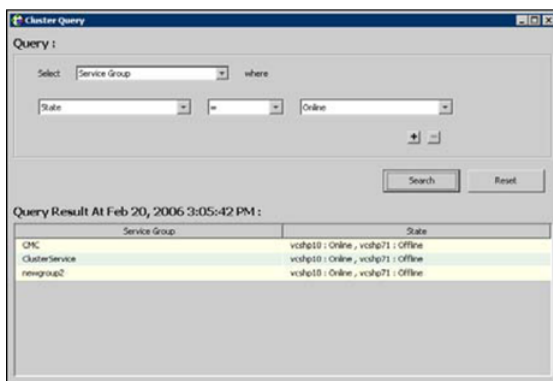

To access the Query dialog box

From Cluster Explorer, click **Query** on the **Tools** menu.

or

In the Cluster Explorer toolbar, click **Query**.

Logs

The Logs dialog box displays the log messages generated by the VCS engine, VCS agents, and commands issued from Cluster Manager to the cluster. Use this dialog box to monitor and take actions on alerts on faulted global clusters and failed service group failover attempts.

Note: To ensure the time stamps for engine log messages are accurate, make sure to set the time zone of the system running the Java Console to the same time zone as the system running the VCS engine.

- Click the **VCS Logs** tab to view the log type, time, and details of an event. Each message presents an icon in the first column of the table to indicate the message type. Use this window to customize the display of messages by setting filter criteria.
- Click the **Agent Logs** tab to display logs according to system, resource type, and resource filter criteria. Use this tab to view the log type, time, and details of an agent event.
- Click the **Command Logs** tab to view the status (success or failure), time, command ID, and details of a command. The Command Log only displays commands issued in the current session.

- Click the **Alerts** tab to view situations that may require administrative action. Alerts are generated when a local group cannot fail over to any system in the local cluster, a global group cannot fail over, or a cluster fault takes place. A current alert will also appear as a pop-up window when you log on to a cluster through the console.

To access the Logs dialog box

From Cluster Explorer, click **Logs** on the **View** menu.

or

On the Cluster Explorer toolbar, click **Show the Logs**.

Server and user credentials

If VCS is running in secure mode, you can view server and user credentials used to connect to the cluster from Cluster Explorer.

To view user credentials

From Cluster Explorer, click **User Credentials** on the **View** menu.

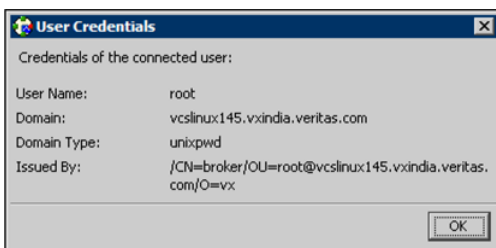

To view server credentials

From Cluster Explorer, click **Server Credentials** on the **View** menu.

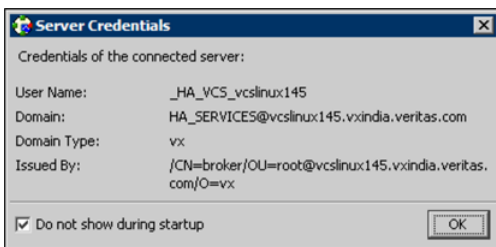

Administering Cluster Monitor

Use the Java Console to administer a cluster or simulated cluster by adding or reconfiguring a cluster panel in Cluster Monitor. To activate the connection to the newly added cluster, complete the following procedure and then click on the newly created connection to log in.

Configuring a new cluster panel

You must add a cluster panel for each cluster that you wish to connect to using the Java GUI.

To configure a new cluster panel

- 1 From Cluster Monitor, click **New Cluster** on the **File** menu. For simulated clusters, click **New Simulator** on the **File** menu.

or

Click **New Cluster** on the Cluster Monitor toolbar.
- 2 Enter the details to connect to the cluster:

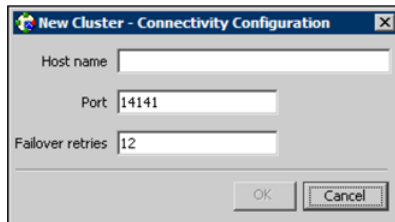

- Enter the host name or IP address of a system in the cluster.
- If necessary, change the default port number of 14141; VCS Simulator uses a default port number of 14153. Note that you must use a different port to connect to each Simulator instance, even if these instances are running on the same system.
- Enter the number of failover retries. VCS sets the default failover retries number to 12.
- For simulated clusters, click the platform for the configuration.
- Click **OK**. An inactive panel appears in Cluster Monitor.

Modifying a cluster panel configuration

Modify a cluster panel to point to another cluster, to change the port number, or the number of failover retries.

- 1 If Cluster Monitor is in the default expanded state, proceed to step 2. If Cluster Monitor is in the collapsed state:

On the **View** menu, click **Expand**.

or

On the **View** menu, click **Stop** when an active panel appears as the view panel.

- 2 Right-click the cluster panel. If the panel is inactive, proceed to step 4.
- 3 On the menu, click **Logout**. The cluster panel becomes inactive.
- 4 Right-click the inactive panel, and click **Configure...**
- 5 Edit the details to connect to the cluster:

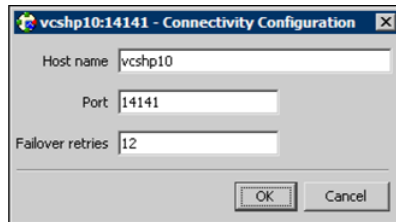

- Enter the host name or IP address of any system in the cluster.
- Enter the port number and the number of failover retries. VCS sets the default port number to 14141 and failover retries number to 12; VCS Simulator uses a default port number of 14153.
- For simulated panels, click the platform for the configuration.
- Click **OK**.

Logging on to a cluster and logging off

After you add or configure a cluster panel in Cluster Monitor, click on the panel to log on to the cluster and access Cluster Explorer. Use Cluster Monitor to log off the cluster when you have completed administering the cluster.

Logging on to a cluster

This topic describes how to log on to a cluster.

- 1 If Cluster Monitor is in the default expanded state, proceed to step 2. If Cluster Monitor is in the collapsed state:

On the **View** menu, click **Expand**.

or

On the **View** menu, click **Stop** when an active panel appears as the view panel.

- 2 Click the panel that represents the cluster you want to log on to.

or

If the appropriate panel is highlighted, click **Login** on the **File** menu.

- 3 Enter the information for the user:

If the cluster is not running in secure mode:

- Enter the VCS user name and password.
- Click **OK**.

If the cluster is running in secure mode:

- Enter the credentials of a native user.

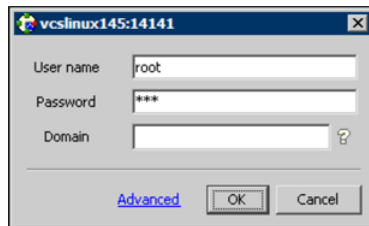

You can use nis or nis+ accounts or accounts set up on the local system. If you do not enter the name of the domain, VCS assumes the domain is the local system.

If the user does not have root privileges on the system, VCS assigns guest privileges to the user. To override these privileges, add the domain user to the VCS administrators' list.

See "[Administering user profiles](#)" on page 123.

- The Java Console connects to the cluster using the authentication broker and the domain type provided by the engine. To change the authentication broker or the domain type, click **Advanced**.

See "[About security services](#)" on page 47.

Select a new broker and domain type, as required.

- Click **OK**.

- The Server Credentials dialog box displays the credentials of the cluster service to which the console is connected.
To disable this dialog box from being displayed every time you connect to the cluster, select the **Do not show during startup** check box
- Click **OK** to connect to the cluster.

The animated display shows various objects, such as service groups and resources, being transferred from the server to the console.

Cluster Explorer is launched automatically upon initial logon, and the icons in the cluster panel change color to indicate an active panel.

Logging off a cluster

To log off a cluster, follow these steps:

- 1 If Cluster Monitor is in the default expanded state, proceed to step 2. If Cluster Monitor is in the collapsed state:

On the **View** menu, click **Expand**.

or

On the **View** menu, click **Stop** when an active panel appears as the view panel.

- 2 Right-click the active panel, and click **Logout**.

or

If the appropriate panel is highlighted, click **Logout** on the **File** menu.

Cluster Explorer closes and the Cluster Monitor panel becomes inactive. You may be prompted to save the configuration if any commands were executed on the cluster.

To log off from Cluster Explorer

Click **Log Out** on the **File** menu.

Administering user profiles

The Java Console enables a user with Cluster Administrator privileges to add, modify, and delete user profiles. The icon next to each user name in the User Manager dialog box indicates privileges for each user. Administrator and Operator privileges are separated into the cluster and group levels.

See [“About VCS user privileges and roles”](#) on page 82.

Adding a user

To add a user, follow these steps:

- 1 From Cluster Explorer, click **User Manager** on the **File** menu.
- 2 In the User Manager dialog box, click **New User**.
- 3 In the Add User dialog box:

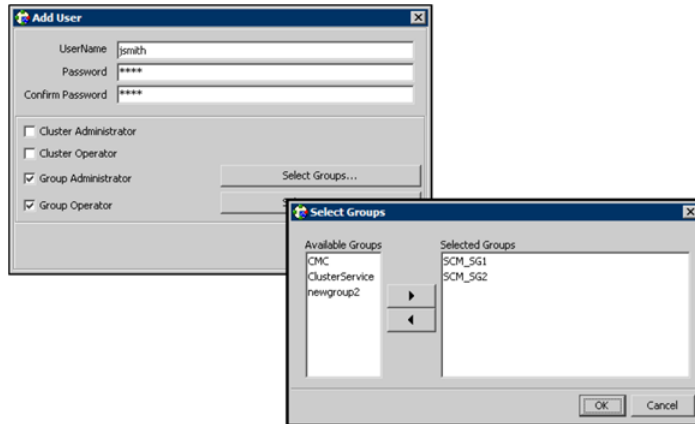

- Enter the name of the user.
 - If the cluster is not running in secure mode, enter a password for the user and confirm it.
 - Select the appropriate check boxes to grant privileges to the user. To grant Group Administrator or Group Operator privileges, proceed to step the next step. Otherwise, proceed to the last step.
 - Click **Select Groups...**
 - Click the groups for which you want to grant privileges to the user and click the right arrow to move the groups to the **Selected Groups** box.
 - Click **OK** to exit the Select Group dialog box, then click **OK** again to exit the Add User dialog box.
- 4 Click **Close**.

Deleting a user

To delete a user, follow these steps:

- 1 From Cluster Explorer, click **User Manager** on the **File** menu.
- 2 In the User Manager dialog box, click the user name.
- 3 Click **Remove User**.
- 4 Click **Yes**.
- 5 Click **Close**.

Changing a user password

A user with Administrator, Operator, or Guest privileges can change his or her own password. You must be logged on as Cluster Administrator to access User Manager. Before changing the password, make sure the configuration is in the read-write mode. Cluster administrators can change the configuration to the read-write mode.

Note: This module is not available if the cluster is running in secure mode.

To change a password as an administrator

- 1 From Cluster Explorer, click **User Manager** on the **File** menu.
- 2 Click the user name.
- 3 Click **Change Password**.
- 4 In the Change Password dialog box:
 - Enter the new password.
 - Re-enter the password in the **Confirm Password** field.
 - Click **OK**.
- 5 Click **Close**.

To change a password as an operator or guest

- 1 From Cluster Explorer, click **Change Password** on the **File** menu.
- 2 In the Change Password dialog box:
 - Enter the new password.
 - Reenter the password in the **Confirm Password** field.
 - Click **OK**.
- 3 Click **Close**.

Changing a user privilege

To change a user privilege, follow these steps:

- 1 From Cluster Explorer, click **User Manager** on the **File** menu.
- 2 Click the user name.
- 3 Click **Change Privileges** and enter the details for user privileges:

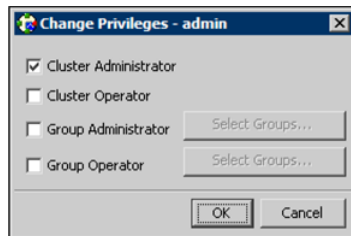

- Select the appropriate check boxes to grant privileges to the user. To grant Group Administrator or Group Operator privileges, proceed to the next step. Otherwise, proceed to the last step.
- Click **Select Groups**.
- Click the groups for which you want to grant privileges to the user, then click the right arrow to move the groups to the **Selected Groups** box.
- Click **OK** in the Change Privileges dialog box, then click **Close** in the User Manager dialog box.

Assigning privileges for OS user groups for clusters running in secure mode

For clusters running in secure mode, you can assign privileges to native users at an operating system (OS) user group level. Assigning VCS privileges to an OS user group involves adding the user group in one (or more) of the following attributes:

- AdministratorGroups—for a cluster or for a service group.
- OperatorGroups—for a cluster or for a service group.

See [“User privileges for OS user groups for clusters running in secure mode”](#) on page 87.

To assign privileges to an OS user group

- 1 From Cluster Explorer configuration tree, select the cluster to assign privileges for the cluster or a service group to assign privileges for specific service groups.
- 2 From the view panel, click the **Properties** tab and then click **Show all attributes**.
- 3 From the list of attributes, click the edit icon against **AdministratorGroups** or **OperatorGroups**.
- 4 In the Edit Attribute dialog box:
 - Use the **+** button to add an element.
 - Click the newly added element and enter the name of the user group in the format:
group@domain
 - Click **OK**.

Administering service groups

Use the Java Console to administer service groups in the cluster. Use the console to add and delete, bring online and take offline, freeze and unfreeze, link and unlink, enable and disable, autoenable, switch, and flush service groups. You can also modify the system list for a service group.

Adding a service group

The Java Console provides several ways to add a service group to the systems in a cluster. Use Cluster Explorer, Command Center, or the Template View to perform this task.

Cluster Explorer provides several ways to add service groups. A few are explained in this section.

To add a service group from Cluster Explorer

- 1 On the **Edit** menu, click **Add**, and click **Service Group**.

or

In the **Service Groups** tab of the configuration tree, right-click a cluster and click **Add Service Group** from the menu.

or

Click **Add Service Group** in the Cluster Explorer toolbar.

- 2 Enter the details of the service group:

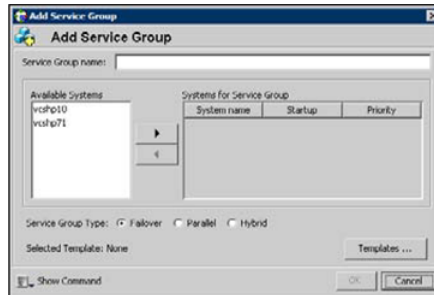

- Enter the name of the service group.
- In the **Available Systems** box, click the systems on which the service group will be added.
- Click the right arrow to move the selected systems to the **Systems for Service Group** box. The priority number (starting with 0) is automatically assigned to indicate the order of systems on which the service group will start in case of a failover. If necessary, double-click the entry in the **Priority** column to enter a new value.
Select the **Startup** check box to add the systems to the service groups AutoStartList attribute. This enables the service group to automatically come online on a system every time HAD is started.
- Click the appropriate service group type. A failover service group runs on only one system at a time; a parallel service group runs concurrently on multiple systems.
- To add a new service group based on a template, click **Templates...** Otherwise, proceed to the last step in this procedure. (Alternative method to add a new service group based on a template: From Cluster Explorer, click **Templates** on the **Tools** menu. Right-click the Template View panel, and click **Add as Service Group** from the menu.)
- Click the appropriate template name, then click **OK**.
- Click **Show Command** in the bottom left corner if you want to view the command associated with the service group. Click **Hide Command** to close the view of the command.
- Click **OK**.

To add a service group from Command Center

- 1 In the Command Center configuration tree, expand **Commands > Configuration > Cluster Objects > Add Service Group**.

or

Click **Add service group** in the Command Center toolbar.

- 2 Enter the name of the service group.

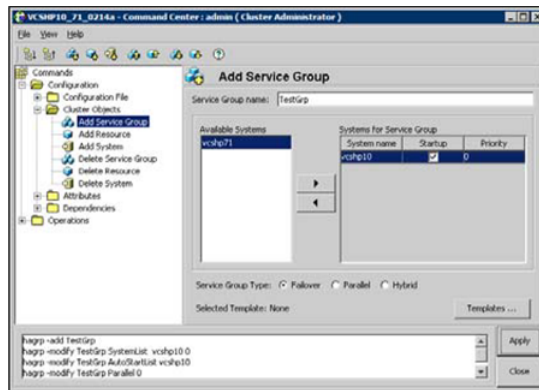

- 3 In the **Available Systems** box, click the systems on which the service group will be added.
- 4 Click the right arrow to move the selected systems to the **Systems for Service Group** box. The priority number (starting with 0) is automatically assigned to indicate the order of systems on which the service group will start in case of a failover. If necessary, double-click the entry in the **Priority** column to enter a new value.

Select the **Startup** check box to add the systems to the service groups AutoStartList attribute. This enables the service group to automatically come online on a system every time HAD is started.

- 5 Click the appropriate service group type. A failover service group runs on only one system at a time; a parallel service group runs concurrently on multiple systems.
- 6 To add a new service group based on a template, click **Templates...** Otherwise, proceed to step 9.
- 7 Click the appropriate template name.
- 8 Click **OK**.
- 9 Click **Apply**.

To add a service group from the template view

- 1 From Cluster Explorer, click **Templates...** on the **Tools** menu.
- 2 Right-click the Template View panel, and click **Add as Service Group** from the pop-up menu. This adds the service group template to the cluster configuration file without associating it to a particular system.

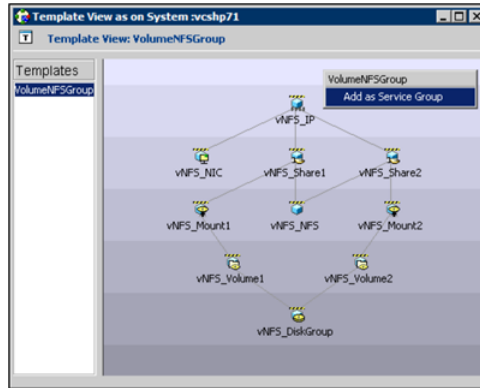

- 3 Use System Manager to add the service group to systems in the cluster.
See “[System Manager](#)” on page 115.

Deleting a service group

Delete a service group from Cluster Explorer or Command Center.

Note: You cannot delete service groups with dependencies. To delete a linked service group, you must first delete the link.

To delete a service group from Cluster Explorer

- 1 In the **Service Groups** tab of the configuration tree, right-click the service group.
or
Click a cluster in the configuration tree, click the **Service Groups** tab, and right-click the service group icon in the view panel.
- 2 Click **Delete** from the menu.
- 3 Click **Yes**.

To delete a service group from Command Center

- 1 In the Command Center configuration tree, expand **Commands > Configuration > Cluster Objects > Delete Service Group**.
- 2 Click the service group.
- 3 Click **Apply**.

Bringing a service group online

To bring a service group online, follow these steps:

To bring a service group online from the Cluster Explorer configuration tree

- 1 In the **Service Groups** tab of the configuration tree, right-click the service group.

or

Click a cluster in the configuration tree, click the **Service Groups** tab, and right-click the service group icon in the view panel.

- 2 Click **Online**, and click the appropriate system from the menu. Click **Any System** if you do not need to specify a system.

To bring a service group online from the Cluster Explorer toolbar

- 1 Click **Online Service Group** on the Cluster Explorer toolbar.
- 2 Specify the details for the service group:

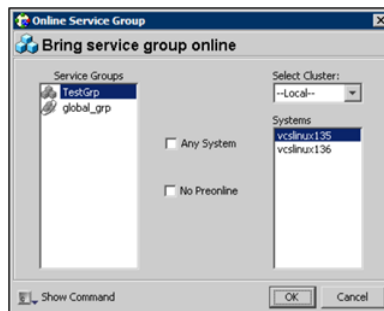

- Click the service group.
- For global groups, select the cluster in which to bring the group online.
- Click the system on which to bring the group online, or select the **Any System** check box.

- Select the **No Preonline** check box to bring the service group online without invoking the preonline trigger.
- Click **Show Command** in the bottom left corner to view the command associated with the service group. Click **Hide Command** to close the view of the command.
- Click **OK**.

To bring a service group online from Command Center

- 1 In the Command Center configuration tree, expand **Commands > Operations > Controls > Online Service Group**.

or

Click **Bring service group online** in the Command Center toolbar.

- 2 Click the service group.
- 3 For global groups, select the cluster in which to bring the group online.
- 4 Click the system on which to bring the group online, or select the **Any System** check box.
- 5 Click **Apply**.

Taking a service group offline

To take a service group offline, follow these steps:

To take a service group offline from Cluster Explorer configuration tree

- 1 In the **Service Groups** tab of the configuration tree, right-click the service group.

or

Click a cluster in the configuration tree, click the **Service Groups** tab, and right-click the service group icon in the view panel.

- 2 Click **Offline**, and click the appropriate system from the menu. Click **All Systems** to take the group offline on all systems.

To take a service group offline from the Cluster Explorer toolbar

- 1 Click **Offline Service Group** in the Cluster Explorer toolbar.
- 2 Enter the details of the service group:

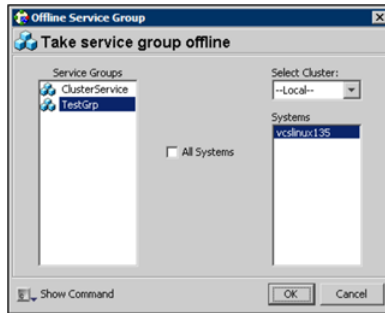

- Click the service group.
- For global groups, select the cluster in which to take the group offline.
- Click the system on which to take the group offline, or click **All Systems**.
- Click **Show Command** in the bottom left corner if you want to view the command associated with the service group. Click **Hide Command** to close the view of the command.
- Click **OK**.

To take a service group offline from Command Center

- 1 In the Command Center configuration tree, expand **Commands > Operations > Controls > Offline Service Group**.

or

Click **Take service group offline** in the Command Center toolbar.

- 2 Click the service group.
- 3 For global groups, select the cluster in which to take the group offline.
- 4 Click the system on which to take the group offline, or click the **All Systems** check box.
- 5 Click **Apply**.

Switching a service group

The process of switching a service group involves taking it offline on its current system and bringing it online on another system.

To switch a service group from Cluster Explorer

- 1 In the **Service Groups** tab of the configuration tree, right-click the service group.

or

Click the cluster in the configuration tree, click the **Service Groups** tab, and right-click the service group icon in the view panel.

- 2 Click **Switch To**, and click the appropriate system from the menu.

To switch a service group from Command Center

- 1 In the Command Center configuration tree, expand **Commands > Operations > Controls > Switch Service Group**.
- 2 Click the service group.
- 3 For global groups, select the cluster in which to switch the service group.
- 4 Click the system on which to bring the group online, or select the **Any System** check box.
- 5 Click **Apply**.

Freezing a service group

Freeze a service group to prevent it from failing over to another system. The freezing process stops all online and offline procedures on the service group. Note that you cannot freeze a service group when the service group state is in transition.

To freeze a service group from Cluster Explorer

- 1 In the **Service Groups** tab of the configuration tree, right-click the service group.

or

Click the cluster in the configuration tree, click the **Service Groups** tab, and right-click the service group icon in the view panel.

- 2 Click **Freeze**, and click **Temporary** or **Persistent** from the menu. The persistent option maintains the frozen state after a reboot if you save this change to the configuration.

To freeze a service group from Command Center

- 1 In the Command Center configuration tree, expand **Commands > Operations > Availability > Freeze Service Group**.
- 2 Click the service group.

- 3 Select the **persistent** check box if necessary. The persistent option maintains the frozen state after a reboot if you save this change to the configuration.
- 4 Click **Apply**.

Unfreezing a service group

Unfreeze a frozen service group to perform online or offline operations on the service group.

To unfreeze a service group from Cluster Explorer

- 1 In the **Service Groups** tab of the configuration tree, right-click the service group.

or

Click the cluster in the configuration tree, click the **Service Groups** tab, and right-click the service group icon in the view panel.
- 2 Click **Unfreeze**.

To unfreeze a service group from Command Center

- 1 In the Command Center configuration tree, expand **Commands > Operations > Availability > Unfreeze Service Group**.
- 2 Click the service group.
- 3 Click **Apply**.

Enabling a service group

Enable a service group before bringing it online. A service group that was manually disabled during a maintenance procedure on a system may need to be brought online after the procedure is completed.

To enable a service group from Cluster Explorer

- 1 In the **Service Groups** tab of the configuration tree, right-click the service group.

or

Click the cluster in the configuration tree, click the **Service Groups** tab, and right-click the service group icon in the view panel.
- 2 Click **Enable**, and click the appropriate system from the menu. Click **All Systems** to enable the group on all systems.

To enable a service group from Command Center

- 1 In the Command Center configuration tree, expand **Commands > Operations > Availability > Enable Service Group**.
- 2 Click the service group.
- 3 Select the **Per System** check box to enable the group on a specific system instead of all systems.
- 4 Click **Apply**.

Disabling a service group

Disable a service group to prevent it from coming online. This process temporarily stops VCS from monitoring a service group on a system undergoing maintenance operations.

To disable a service group from Cluster Explorer

- 1 In the **Service Groups** tab of the configuration tree, right-click the service group.
or
Click the cluster in the configuration tree, click the **Service Groups** tab, and right-click the service group icon in the view panel.
- 2 Click **Disable**, and click the appropriate system in the menu. Click **All Systems** to disable the group on all systems.

To disable a service group from Command Center

- 1 In the Command Center configuration tree, expand **Commands > Operations > Availability > Disable Service Group**.
- 2 Click the service group.
- 3 Select the **Per System** check box to disable the group on a specific system instead of all systems.
- 4 Click **Apply**.

Autoenabling a service group

A service group is auto-disabled until VCS probes all resources and checks that they are ready to come online. Autoenable a service group in situations where the VCS engine is not running on one of the systems in the cluster, and you must override the disabled state of the service group to enable the group on another system in the cluster.

To autoenable a service group from Cluster Explorer

- 1 In the **Service Groups** tab of the configuration tree, right-click the service group.
or
Click the cluster in the configuration tree, click the **Service Groups** tab, and right-click the service group icon in the view panel.
- 2 Click **Autoenable**, and click the appropriate system from the menu.

To autoenable a service group from Command Center

- 1 In the Command Center configuration tree, expand **Commands > Operations > Availability > Autoenable Service Group**.
- 2 Click the service group.
- 3 Click the system on which to autoenable the group.
- 4 Click **Apply**.

Flushing a service group

When a service group is brought online or taken offline, the resources within the group are brought online or taken offline. If the online operation or offline operation hangs on a particular resource, flush the service group to clear the WAITING TO GO ONLINE or WAITING TO GO OFFLINE states from its resources. Flushing a service group typically leaves the service group in a partial state. After you complete this process, resolve the issue with the particular resource (if necessary) and proceed with starting or stopping the service group.

Note: The flush operation does not halt the resource operations (such as online, offline, migrate, and clean) that are running. If a running operation succeeds after a flush command was fired, the resource state might change depending on the operation.

To flush a service group from Cluster Explorer

- 1 In the **Service Groups** tab of the configuration tree, right-click the service group.
or
Click the cluster in the configuration tree, click the **Service Groups** tab, and right-click the service group icon in the view panel.
- 2 Click **Flush**, and click the appropriate system from the menu.

To flush a service group from Command Center

- 1 In the Command Center configuration tree, expand **Commands > Operations > Availability > Flush Service Group**.
- 2 Click the service group.
- 3 Click the system on which to flush the service group.
- 4 Click **Apply**.

Linking service groups

This topic describes how to link service groups.

To link a service group from Cluster Explorer

- 1 Click a cluster in the configuration tree.
- 2 In the View panel, click the **Service Groups** tab. This opens the service group dependency graph. To link a parent group with a child group:
 - Click **Link**.
 - Click the parent group.
 - Move the mouse toward the child group. The yellow line "snaps" to the child group. If necessary, press Esc on the keyboard to delete the line between the parent and the pointer before it snaps to the child.
 - Click the child group.
 - In the Link Service Groups dialog box, click the group relationship and dependency type.
See "[About service group dependencies](#)" on page 475.
 - Click **OK**.

You can also link the service groups by performing steps 1 and 2, right-clicking the parent group, and clicking **Link** from the menu. In the dialog box, click the child group, relationship, dependency type, and click **OK**.

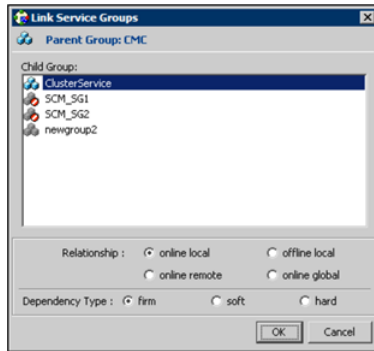

To link a service group from Command Center

- 1 In the Command Center configuration tree, expand **Commands > Configuration > Dependencies > Link Service Groups**.
- 2 Click the parent resource group in the **Service Groups** box. After selecting the parent group, the potential groups that can serve as child groups are displayed in the **Child Service Groups** box.
- 3 Click a child service group.
- 4 Click the group relationship and dependency type.
 See [“About service group dependencies”](#) on page 475.
- 5 Click **Apply**.

Unlinking service groups

To unlink service groups, follow these steps:

To delete a service group dependency from Cluster Explorer

- 1 Click a cluster in the configuration tree.
- 2 In the view panel, click the **Service Groups** tab.
- 3 In the Service Group view, right-click the link between the service groups.

- 4 Click **Unlink** from the menu.

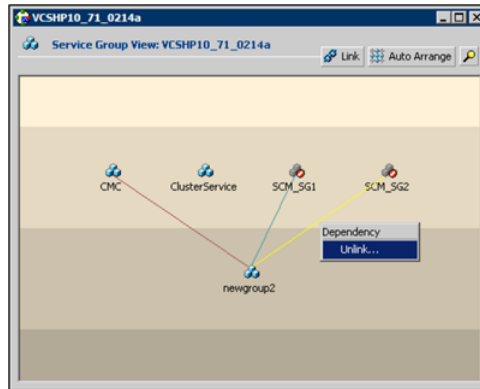

- 5 Click **Yes**.

To delete a service group dependency from Command Center

- 1 In the Command Center configuration tree, expand **Commands > Configuration > Dependencies > Unlink Service Groups**.
- 2 Click the parent resource group in the **Service Groups** box. After selecting the parent group, the corresponding child groups are displayed in the **Child Service Groups** box.
- 3 Click the child service group.
- 4 Click **Apply**.

Managing systems for a service group

From Cluster Explorer, use System Manager to add and remove systems in a service group's system list.

To add a system to the service group's system list

- 1 In the System Manager dialog box, click the system in the **Available Systems** box.

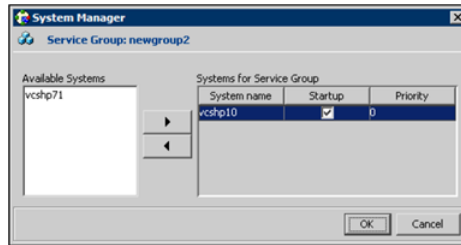

- 2 Click the right arrow to move the available system to the **Systems for Service Group** table.
- 3 Select the **Startup** check box to add the systems to the service groups AutoStartList attribute. This enables the service group to automatically come online on a system every time HAD is started.
- 4 The priority number (starting with 0) is assigned to indicate the order of systems on which the service group will start in case of a failover. If necessary, double-click the entry in the **Priority** column to enter a new value.
- 5 Click **OK**.

To remove a system from the service group's system list

- 1 In the System Manager dialog box, click the system in the **Systems for Service Group** table.
- 2 Click the left arrow to move the system to the **Available Systems** box.
- 3 Click **OK**.

Creating service groups with the configuration wizard

This section describes how to create service groups using the configuration wizard.

Note: VCS also provides wizards to create service groups for applications and NFS shares. See the chapter "Configuring applications and resources in VCS" for more information about these wizards.

To create a service group using the configuration wizard

- 1 Open the Configuration Wizard. From Cluster Explorer, click **Configuration Wizard** on the **Tools** menu.
- 2 Read the information on the Welcome dialog box and click **Next**.
- 3 Specify the name and target systems for the service group:

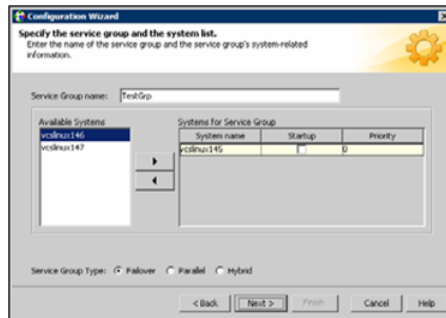

- Enter the name of the group.
 - Click the target systems in the **Available Systems** box.
 - Click the right arrow to move the systems to the **Systems for Service Group** table. To remove a system from the table, click the system and click the left arrow.
 - Select the **Startup** check box to add the systems to the service groups AutoStartList attribute. This enables the service group to automatically come online on a system every time HAD is started.
 - The priority number (starting with 0) is automatically assigned to indicate the order of systems on which the service group will start in case of a failover. If necessary, double-click the entry in the **Priority** column to enter a new value.
 - Click the service group type.
 - Click **Next**.
- 4 Click **Next** again to configure the service group with a template and proceed to 7. Click **Finish** to add an empty service group to the selected cluster systems and configure it at a later time.
 - 5 Click the template on which to base the new service group. The Templates box lists the templates available on the system to which Cluster Manager is connected. The resource dependency graph of the templates, the number of resources, and the resource types are also displayed. Click **Next**.

- 6 If a window notifies you that the name of the service group or resource within the service group is already in use, proceed to 9.
- 7 Click **Next** to apply all of the new names listed in the table to resolve the name clash.
 or
 Modify the clashing names by entering text in the field next to the **Apply** button, clicking the location of the text for each name from the **Correction** drop-down list box, clicking **Apply**, and clicking **Next**.
- 8 Click **Next** to create the service group. A progress indicator displays the status.
- 9 After the service group is successfully created, click **Next** to edit attributes using the wizard. Click **Finish** to edit attributes at a later time using Cluster Explorer.
- 10 Review the attributes associated with the resources of the service group. If necessary, proceed to 11 to modify the default values of the attributes. Otherwise, proceed to 12 to accept the default values and complete the configuration.
- 11 Modify the values of the attributes (if necessary).

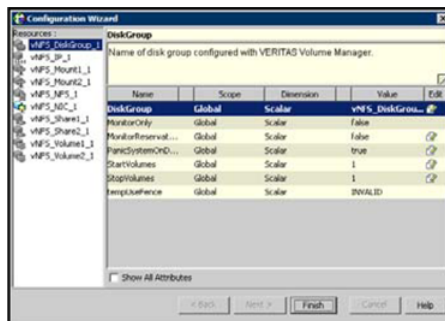

- Click the resource.
 - Click the attribute to be modified.
 - Click the **Edit** icon at the end of the table row.
 - In the Edit Attribute dialog box, enter the attribute values.
 - Click **OK**.
 - Repeat the procedure for each resource and attribute.
- 12 Click **Finish**.

Administering resources

Use the Java Console to administer resources in the cluster. Use the console to add and delete, bring online and take offline, probe, enable and disable, clear, and link and unlink resources. You can also import resource types to the configuration.

Adding a resource

The Java Console provides several ways to add a resource to a service group. Use Cluster Explorer or Command Center to perform this task.

To add a resource from Cluster Explorer

- 1 In the **Service Groups** tab of the Cluster Explorer configuration tree, click a service group to which the resource will be added.
- 2 On the **Edit** menu, click **Add**, and click **Resource**.
or
Click **Add Resource** in the Cluster Explorer toolbar.
- 3 Enter the details of the resource:
 - Enter the name of the resource.
 - Click the resource type.
 - Edit resource attributes according to your configuration. The Java Console also enables you to edit attributes after adding the resource.
 - Select the **Critical** and **Enabled** check boxes, if applicable. The **Critical** option is selected by default.
A critical resource indicates the service group is faulted when the resource, or any resource it depends on, faults. An enabled resource indicates agents monitor the resource; you must specify the values of mandatory attributes before enabling a resource. If a resource is created dynamically while VCS is running, you must enable the resource before VCS monitors it. VCS will not bring a disabled resource nor its children online, even if the children are enabled.
 - Click **Show Command** in the bottom left corner to view the command associated with the resource. Click **Hide Command** to close the view of the command.
 - Click **OK**.

To add a resource from Command Center

- 1 In the Command Center configuration tree, expand **Commands > Configuration > Cluster Objects > Add Resource**.

or

Click **Add resource** in the Command Center toolbar.

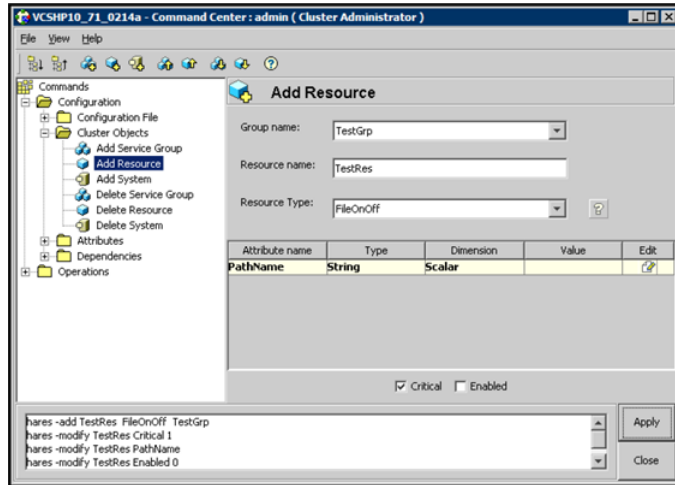

- 2 Select the service group to contain the resource.
- 3 Enter the name of the resource.
- 4 Click the resource type.
- 5 Edit resource attributes according to your configuration. The Java Console also enables you to edit attributes after adding the resource.
- 6 Select the **Critical** and **Enabled** check boxes, if applicable. The **Critical** option is selected by default.

A critical resource indicates the service group is faulted when the resource, or any resource it depends on, faults. An enabled resource indicates agents monitor the resource; you must specify the values of mandatory attributes before enabling a resource. If a resource is created dynamically while VCS is running, you must enable the resource before VCS monitors it. VCS will not bring a disabled resource nor its children online, even if the children are enabled.

- 7 Click **Apply**.

To add a resource from the Template view

- 1 From Cluster Explorer, click **Templates...** on the **Tools** menu.
- 2 In the left pane of the Template View, click the template from which to add resources to your configuration.
- 3 In the resource graph, right-click the resource to be added to your configuration.

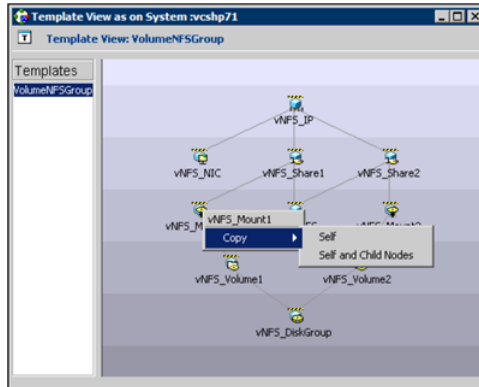

- 4 Click **Copy**, and click **Self** from the menu to copy the resource. Click **Copy**, and click **Self and Child Nodes** from the menu to copy the resource with its dependent resources.
- 5 In the **Service Groups** tab of the Cluster Explorer configuration tree, click the service group to which to add the resources.
- 6 In the Cluster Explorer view panel, click the **Resources** tab.
- 7 Right-click the Resource view panel and click **Paste** from the menu. After the resources are added to the service group, edit the attributes to configure the resources.

Adding a RemoteGroup resource from the Java Console

A RemoteGroup resource is typically useful in scenarios where resources configured in a local service group are dependant on the state of a remote service group. For example, a web-server application running in a local cluster could be dependant on a database application running in a remote cluster.

Note: The RemoteGroup agent represents that state of a failover service group; the agent is not supported with parallel service groups.

A RemoteGroup resource monitors the state of a remote service group in a local cluster. Once you have added the RemoteGroup resource to a local service group, you can link the resource to the existing resources of the service group.

You must have administrative privileges to configure RemoteGroup resources.

See [“About configuring the RemoteGroup agent”](#) on page 291.

To add a RemoteGroup resource

- 1 On the **Tools** menu, click **Add Remote Group Resource...**
or
Click **Configure Remote Group Resource Wizard** in the Cluster Explorer toolbar.
- 2 Read the information on the Welcome dialog box and click **Next**.
- 3 In the Remote Group Resource Name dialog box, specify the name of the resource and the service group to which the resource will be added. Click **Next**.
- 4 In the Remote Cluster Information dialog box:
 - Specify the name or IP address of a node in the remote cluster.
 - Specify the port on the remote node on which the resource will communicate.
 - Specify a username for the remote cluster.
 - Specify a password for the user.
 - Select the check box if you wish to specify advance options to connect to a cluster running in secure mode. Otherwise, click **Next** and proceed to the last step.
 - Specify the domain of which the node is a part.
 - Select a domain type.
 - Specify the authentication broker and port.
 - Click **Next**.
- 5 In the Remote Group Resource Details dialog box, do the following:
 - Select a group you wish to monitor.
 - Select the mode of monitoring.
 - Choose the **MonitorOnly** option to monitor the remote service group. You will not be able to perform online or offline operations on the remote group.
 - Choose the **OnlineOnly** option to monitor the remote service group and bring the remote group online from the local cluster.

- Choose the **OnOff** option to monitor the remote service group, bring the remote group online, and take it offline from the local cluster.
- Specify whether the RemoteGroup resource should monitor the state of the remote group on a specific system or any system in the remote cluster.
 - Choose the **Any System** option to enable the RemoteGroup resource to monitor the state of the remote service group irrespective of the system on which it is online.
 - Choose the **Specific System** option to enable the RemoteGroup resource to monitor the state of the remote group on a specific system in the remote cluster. You must configure both service groups on the same number of systems.

This option provides one-to-one mapping between the local and remote systems. The **Local Systems** list displays the systems on which the RemoteGroup resource is configured. Click the fields under the **Remote Systems** list and select the systems from drop-down list. If the remote group fails over to another system in the remote cluster, the RemoteGroup resource also will fail over to the corresponding system in the local cluster.
- Click **Next**.

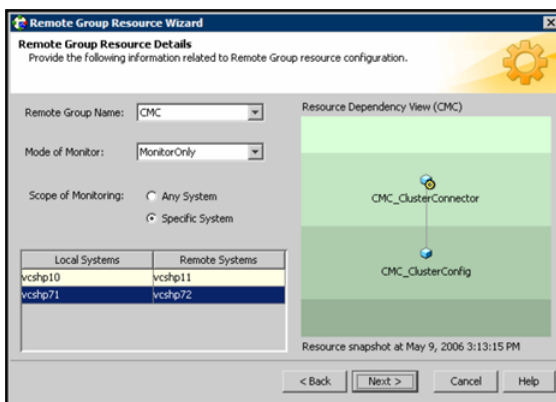

- 6 Review the text in the dialog box and click **Finish** to add the RemoteGroup resource to the specified service group in the local cluster.
- 7 Create dependencies between the RemoteGroup resource and the existing resources of the service group.

See [“Linking resources”](#) on page 154.

Deleting a resource

This topic describes how to delete a resource.

To delete a resource from Cluster Explorer

- 1 In the **Service Groups** tab of the configuration tree, right-click the resource.
or
Click a service group in the configuration tree, click the **Resources** tab, and right-click the resource icon in the view panel.

- 2 Click **Delete** from the menu.

- 3 Click **Yes**.

To delete a resource from Command Center

- 1 In the Command Center configuration tree, expand **Commands > Configuration > Cluster Objects > Delete Resource**.
- 2 Click the resource.
- 3 Click **Apply**.

Bringing a resource online

This topic describes how to bring a resource offline.

To bring a resource online from Cluster Explorer

- 1 In the **Service Groups** tab of the configuration tree, right-click the resource.
or
Click a service group in the configuration tree, click the **Resources** tab, and right-click the resource icon in the view panel.

- 2 Click **Online**, and click the appropriate system from the menu.

To bring a resource online from Command Center

- 1 In the Command Center configuration tree, expand **Commands > Operations > Controls > Online Resource**.
- 2 Click a resource.
- 3 Click a system on which to bring the resource online.
- 4 Click **Apply**.

Taking a resource offline

This topic describes how to take a resource offline.

To take a resource offline from Cluster Explorer

- 1 In the **Service Groups** tab of the configuration tree, right-click the resource.
or
Click a service group in the configuration tree, click the **Resources** tab, and right-click the resource icon in the view panel.
- 2 Click **Offline**, and click the appropriate system from the menu.

To take a resource offline from Command Center

- 1 In the Command Center configuration tree, expand **Commands > Operations > Controls > Offline Resource**.
- 2 Click a resource.
- 3 Click a system on which to take the resource offline.
- 4 If necessary, select the **ignoreparent** check box to take a selected child resource offline, regardless of the state of the parent resource. This option is only available through Command Center.
- 5 Click **Apply**.

Taking a resource offline and propagating the command

Use the Offline Propagate (OffProp) feature to propagate the offline state of a parent resource. This command signals that resources dependent on the parent resource should also be taken offline.

Use the Offline Propagate (OffProp) "ignoreparent" feature to take a selected resource offline, regardless of the state of the parent resource. This command propagates the offline state of the selected resource to the child resources. The "ignoreparent" option is only available in Command Center.

To take a resource and its child resources offline from Cluster Explorer

- 1 In the Resources tab of the configuration tree, right-click the resource.
- 2 Click **Offline Prop**, and click the appropriate system from the menu.

To take a resource and its child resources offline from Command Center

- 1 In the Command Center configuration tree, expand **Commands > Operations > Controls > OffProp Resource**.
- 2 Click the resource.
- 3 Click the system on which to take the resource, and the child resources, offline.
- 4 Click **Apply**.

To take child resources offline from Command Center while ignoring the state of the parent resource

- 1 In the Command Center configuration tree, expand **Commands > Operations > Controls > OffProp Resource**.
- 2 Click the resource.
- 3 Click the system on which to take the resource, and the child resources, offline.
- 4 Select the **ignoreparent** check box.
- 5 Click **Apply**.

Probing a resource

This topic describes how to probe a resource to check that it is configured. For example, you might probe a resource to check if it is ready to be brought online.

To probe a resource from Cluster Explorer

- 1 In the **Service Groups** tab of the configuration tree, right-click the resource.
- 2 Click **Probe**, and click the appropriate system from the menu.

To probe a resource from Command Center

- 1 In the Command Center configuration tree, expand **Commands > Operations > Controls > Probe Resource**.
- 2 Click the resource.
- 3 Click the system on which to probe the resource.
- 4 Click **Apply**.

Overriding resource type static attributes

You can override some resource attributes of type static and assign them resource-specific values. When you override a static attribute and save the configuration, the main.cf file includes a line in the resource definition for the static attribute and its overridden value.

To override resource type static attribute

- 1 Right-click the resource in the **Service Groups** tab of the configuration tree or in the **Resources** tab of the view panel.
- 2 Click **Override Attributes**.
- 3 Select the attributes to override.

- 4 Click **OK**.

The selected attributes appear in the Overridden Attributes table in the Properties view for the resource.

- 5 To modify the default value of an overridden attribute, click the icon in the **Edit** column of the attribute.

To restore default settings to a type's static attribute

- 1 Right-click the resource in the **Service Groups** tab of the configuration tree or in the **Resources** tab of the view panel.
- 2 Click **Remove Attribute Overrides**.
- 3 Select the overridden attributes to be restored to their default settings.
- 4 Click **OK**.

Enabling resources in a service group

Enable resources in a service group to bring the disabled resources online. A resource may have been manually disabled to temporarily stop VCS from monitoring the resource. You must specify the values of mandatory attributes before enabling a resource.

To enable an individual resource in a service group

- 1 From Cluster Explorer, click the **Service Groups** tab of the configuration tree.
- 2 Right-click a disabled resource in the configuration tree, and click **Enabled** from the menu.

To enable all resources in a service group from Cluster Explorer

- 1 From Cluster Explorer, click the **Service Groups** tab in the configuration tree.
- 2 Right-click the service group.
- 3 Click **Enable Resources**.

To enable all resources in a service group from Command Center

- 1 In the Command Center configuration tree, expand **Commands > Operations > Availability > Enable Resources for Service Group**.
- 2 Click the service group.
- 3 Click **Apply**.

Disabling resources in a service group

Disable resources in a service group to prevent them from coming online. This disabling process is useful when you want VCS to temporarily "ignore" resources (rather than delete them) while the service group is still online.

To disable an individual resource in a service group

- 1 From Cluster Explorer, click the **Service Groups** tab in the Cluster Explorer configuration tree.
- 2 Right-click a resource in the configuration tree. An enabled resource will display a check mark next to the **Enabled** option that appears in the menu.
- 3 Click **Enabled** from the menu to clear this option.

To disable all resources in a service group from Cluster Explorer

- 1 From Cluster Explorer, click the **Service Groups** tab in the configuration tree.
- 2 Right-click the service group and click **Disable Resources**.

To disable all resources in a service group from Command Center

- 1 In the Command Center configuration tree, expand **Commands > Operations > Availability > Disable Resources for Service Group**.
- 2 Click the service group.
- 3 Click **Apply**.

Clearing a resource

Clear a resource to remove a fault and make the resource available to go online. A resource fault can occur in a variety of situations, such as a power failure or a faulty configuration.

To clear a resource from Cluster Explorer

- 1 In the **Service Groups** tab of the configuration tree, right-click the resource.
- 2 Click **Clear Fault**, and click the system from the menu. Click **Auto** instead of a specific system to clear the fault on all systems where the fault occurred.

To clear a resource from Command Center

- 1 In the Command Center configuration tree, expand **Commands > Operations > Availability > Clear Resource**.
- 2 Click the resource. To clear the fault on all systems listed in the **Systems** box, proceed to step 5. To clear the fault on a specific system, proceed to step 3.
- 3 Select the **Per System** check box.

- 4 Click the system on which to clear the resource.
- 5 Click **Apply**.

Linking resources

Use Cluster Explorer or Command Center to link resources in a service group.

To link resources from Cluster Explorer

- 1 In the configuration tree, click the **Service Groups** tab.
- 2 Click the service group to which the resources belong.
- 3 In the view panel, click the **Resources** tab. This opens the resource dependency graph.

To link a parent resource with a child resource, do the following:

- Click **Link...**
- Click the parent resource.
- Move the mouse towards the child resource. The yellow line "snaps" to the child resource. If necessary, press Esc to delete the line between the parent and the pointer before it snaps to the child.
- Click the child resource.
- In the Confirmation dialog box, click **Yes**.
or
Right-click the parent resource, and click **Link** from the menu. In the Link Resources dialog box, click the resource that will serve as the child. Click **OK**.
- Click **OK**.

To link resources from Command Center

- 1 In the Command Center configuration tree, expand **Commands > Configuration > Dependencies > Link Resources**.
- 2 Click the service group to contain the linked resources.

- 3 Click the parent resource in the **Service Group Resources** box. After selecting the parent resource, the potential resources that can serve as child resources are displayed in the **Child Resources** box.

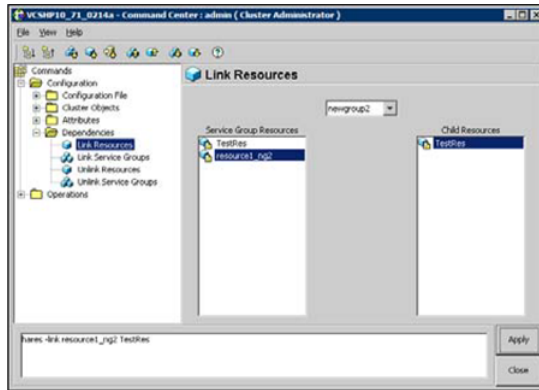

- 4 Click a child resource.
- 5 Click **Apply**.

Unlinking resources

Use Cluster Explorer or Command Center to unlink resources in a service group.

To unlink resources from Cluster Explorer

- 1 From the configuration tree, click the **Service Groups** tab.
- 2 Click the service group to which the resources belong.
- 3 In the view panel, click the **Resources** tab.
- 4 In the Resources View, right-click the link between the resources.

- 5 Click **Unlink...** from the menu.

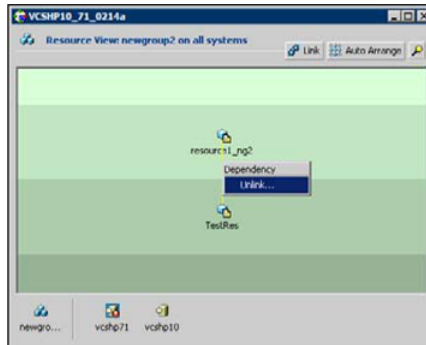

- 6 In the Question dialog box, click **Yes** to delete the link.

To unlink resources from Command Center

- 1 In the Command Center configuration tree, expand **Commands > Configuration > Dependencies > Unlink Resources**.
- 2 Click the service group that contains the linked resources.
- 3 Click the parent resource in the **Service Group Resources** box. After selecting the parent resource, the corresponding child resources are displayed in the **Child Resources** box.

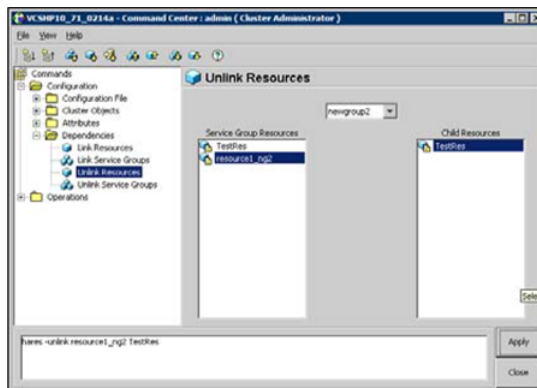

- 4 Click the child resource.
- 5 Click **Apply**.

Invoking a resource action

Cluster Explorer enables you to initiate a predefined action script. Some examples of predefined resource actions are splitting and joining disk groups.

To invoke a resource action

- 1 In the **Service Groups** tab of the configuration tree, right-click the resource.
- 2 Click **Actions...**
- 3 Specify the details of the action as follows:
 - Click the predefined action to execute.
 - Click the system on which to execute the action.
 - To add an argument, click the **Add** icon (+) and enter the argument. Click the **Delete** icon (-) to remove an argument.
 - Click **OK**.

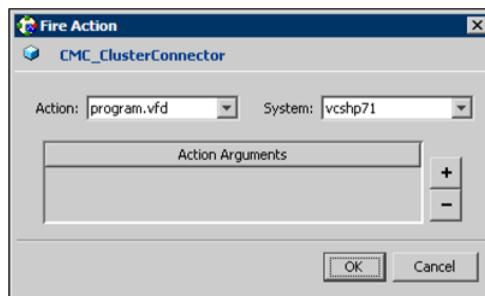

Refreshing the ResourceInfo attribute

Refresh the ResourceInfo attribute to view the latest values for that attribute.

To refresh the ResourceInfo attribute

- 1 In the **Service Groups** tab of the configuration tree, right-click the resource.
- 2 Click **Refresh ResourceInfo**, and click the system on which to refresh the attribute value.

Clearing the ResourceInfo attribute

Clear the ResourceInfo attribute to reset all the parameters in this attribute.

To clear the parameters of the ResourceInfo attribute

- 1 In the **Service Groups** tab of the configuration tree, right-click the resource.
- 2 Click **Clear ResourceInfo**, and click the system on which to reset the attribute value.

Importing resource types

The Java Console enables you to import resource types into your configuration (main.cf). For example, use this procedure to import the types.cf for enterprise agents to your configuration. You cannot import resource types that already exist in your configuration.

To import a resource type from Cluster Explorer

- 1 On the **File** menu, click **Import Types**.
- 2 In the Import Types dialog box:
 - Click the file from which to import the resource type. The dialog box displays the files on the system that Cluster Manager is connected to.
 - Click **Import**.

Running HA fire drill from the Java Console

Use the Cluster Manager to run HA fire drills for specific resources in a local cluster. You can run HA fire drill for agents that support the functionality.

To run HA fire drill

- 1 On the Cluster Explorer toolbar, click **Virtual Fire Drill**.
or
From Cluster Explorer, click **Virtual Fire Drill...** on the **Tools** menu.
- 2 Specify details to run a virtual fire drill as follows:
 - Select the type of check to run.
 - Select a service group for which to run the infrastructure checks. Make sure you select a service group that is online.
 - Select a system to run the checks on.
 - Click **Perform checks**.
 - View the result of the check. If the virtual fire drill reports any errors, right-click the resource and select **Fix it...**

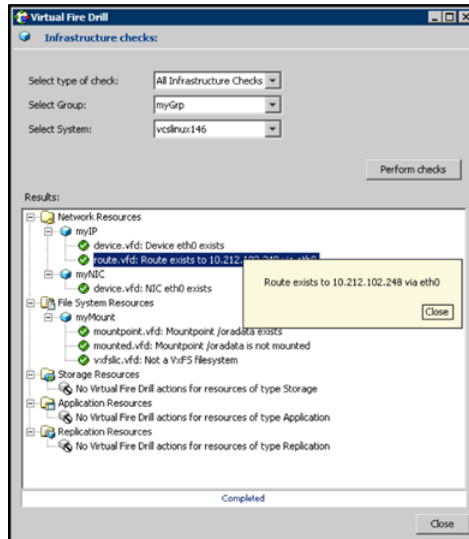

- 3 Click **Close**.

Administering systems

Use the Java Console to administer systems in the cluster. Use the console to add, delete, freeze, and unfreeze systems.

Adding a system

Cluster Explorer and Command Center enable you to add a system to the cluster. A system must have an entry in the LLTTab configuration file before it can be added to the cluster.

To add a system from Cluster Explorer

- 1 On the **Edit** menu, click **Add**, and click **System**.
or
Click **Add System** on the Cluster Explorer toolbar.
- 2 Enter the name of the system.
- 3 Click **Show Command** in the bottom left corner to view the command associated with the system. Click **Hide Command** to close the view of the command.
- 4 Click **OK**.

To add a system from Command Center

- 1 Click **Add System** in the Command Center toolbar.
or
In the Command Center configuration tree, expand **Commands > Configuration > Cluster Objects > Add System**.
- 2 Enter the name of the system.
- 3 Click **Apply**.

Deleting a system

This topic describes how to delete a system.

To delete a system from Command Center

- 1 In the Command Center configuration tree, expand **Commands > Configuration > Cluster Objects > Delete System**.
- 2 Click the system.
- 3 Click **Apply**.

Freezing a system

Freeze a system to prevent service groups from coming online on the system.

To freeze a system from Cluster Explorer

- 1 Click the **Systems** tab of the configuration tree.
- 2 In the configuration tree, right-click the system, click **Freeze**, and click **Temporary** or **Persistent** from the menu. The persistent option maintains the frozen state after a reboot if the user saves this change to the configuration.

To freeze a system from Command Center

- 1 In the Command Center configuration tree, expand **Commands > Operations > Availability > Freeze System**.
- 2 Click the system.
- 3 If necessary, select the **persistent** and **evacuate** check boxes. The evacuate option moves all service groups to a different system before the freeze operation takes place. The persistent option maintains the frozen state after a reboot if the user saves this change to the configuration.
- 4 Click **Apply**.

Unfreezing a system

Unfreeze a frozen system to enable service groups to come online on the system.

To unfreeze a system from Cluster Explorer

- 1 Click the **Systems** tab of the configuration tree.
- 2 In the configuration tree, right-click the system and click **Unfreeze**.

To unfreeze a system from Command Center

- 1 In the Command Center configuration tree, expand **Commands > Operations > Availability > Unfreeze System**.
- 2 Click the system.
- 3 Click **Apply**.

Administering clusters

Use the Java Console to specify the clusters you want to view from the console, and to modify the VCS configuration. The configuration describes the parameters of the entire cluster. Use Cluster Explorer or Command Center to open, save, and "save and close" a configuration.

Opening a cluster configuration

Use Cluster Explorer or Command Center to open or make changes to the VCS configuration.

To open a configuration from Cluster Explorer

- ◆ On the **File** menu, click **Open Configuration**.

or

Click **Open Configuration** on the Cluster Explorer toolbar.

To open a configuration from Command Center

- 1 In the Command Center configuration tree, expand **Commands > Configuration > Configuration File > Open Configuration**.
- 2 Click **Apply**.

Saving a cluster configuration

After updating the VCS configuration, use Cluster Explorer or Command Center to save the latest configuration to disk while maintaining the configuration state in read-write mode.

To save a configuration from Cluster Explorer

- ◆ On the **File** menu, click **Save Configuration**.

or

Click **Save Configuration** on the Cluster Explorer toolbar.

To save a configuration from Command Center

- 1 In the Command Center configuration tree, expand **Commands > Configuration > Configuration File > Save Configuration**.
- 2 Click **Apply**.

Saving and closing a cluster configuration

After you update the VCS configuration, use Cluster Explorer or Command Center to save the latest configuration to disk, and close or change the configuration state to read-only mode.

To save and close a configuration from Cluster Explorer

- ◆ On the **File** menu, click **Close Configuration**.

or

Click **Save and Close Configuration** on the Cluster Explorer toolbar.

To save and close a configuration from Command Center

- 1 In the Command Center configuration tree, expand **Commands > Configuration > Configuration File > Close Configuration**.
- 2 Click **Apply**.

Running commands

Use Command Center to run commands on a cluster.

Commands are organized within the Command Center as "Configuration" commands and "Operation" commands.

To run a command from Command Center

- 1 From Command Center, click the command from the command tree. If necessary, expand the tree to view the command.
- 2 In the corresponding command interface, click the VCS objects and appropriate options (if necessary).
- 3 Click **Apply**.

Editing attributes

Use the Java Console to edit attributes of VCS objects. By default, the Java Console displays key attributes and type specific attributes. To view all attributes associated with an object, click **Show all attributes**.

To edit an attribute from Cluster Explorer

- 1 From the Cluster Explorer configuration tree, click the object whose attributes you want to edit.
- 2 In the view panel, click the **Properties** tab. If the attribute does not appear in the Properties View, click **Show all attributes**.
- 3 In the Properties or Attributes View, click the icon in the **Edit** column of the **Key Attributes** or **Type Specific Attributes** table. In the Attributes View, click the icon in the **Edit** column of the attribute.
- 4 In the Edit Attribute dialog box, enter the changes to the attribute values as follows:
 - To edit a scalar value:
Enter or click the value.
 - To edit a non-scalar value:
Use the **+** button to add an element. Use the **-** button to delete an element.
 - To change the attribute's scope:
Click the **Global** or **Per System** option.
 - To change the system for a local attribute:
Click the system from the menu.
- 5 Click **OK**.

To edit an attribute from Command Center

- 1 In the Command Center configuration tree, expand **Commands > Configuration > Attributes > Modify vcs_object Attributes**.
- 2 Click the VCS object from the menu.

- 3 In the attribute table, click the icon in the **Edit** column of the attribute.

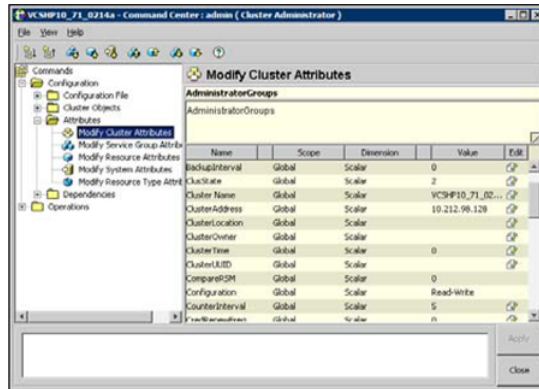

- 4 In the Edit Attribute dialog box, enter the changes to the attribute values as follows:
 - To edit a scalar value:
Enter or click the value.
 - To edit a non-scalar value:
Use the + button to add an element. Use the - button to delete an element.
 - To change the attribute's scope:
Click the **Global** or **Per System** option.
 - To change the system for a local attribute:
Click the system from the menu.
- 5 Click **OK**.

Querying the cluster configuration

This topic describes how to perform a query on a cluster configuration, follow these steps:

- 1 From Cluster Explorer, click **Query** on the **Tools** menu.
or
On the Cluster Explorer toolbar, click **Query**.
- 2 In the Cluster Query dialog box, enter the details of the query:

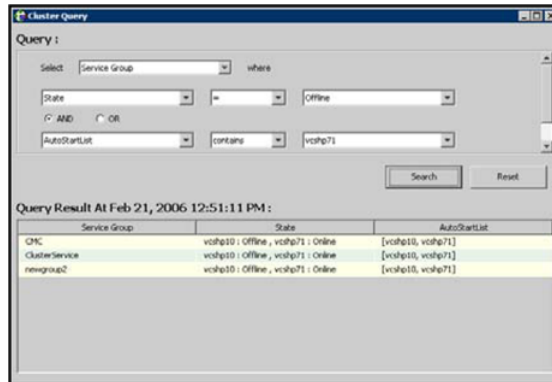

- Click the VCS object to search.
- Depending on the selected object, click the specific entity to search.
- Click the appropriate phrase or symbol between the search item and value.
- Click the appropriate value for the specified query.
- Certain queries allow the user to enter specific filter information:
 Click **System**, click **Online Group Count**, click **<**, and type the required value in the blank field.
 or
 Click **Resource**, click **[provide attribute name]** and type in the name of an attribute, click **=** or **contains**, and type the appropriate value of the attribute in the blank field.
 For example, click **Resource**, click **[provide attribute name]** and type in **MountPoint**, click **contains**, and type **/db01** in the blank field.
- To use additional queries, click **+** as many times as necessary to select the appropriate options. Click **-** to reduce the number of queries.
- Click **AND** or **OR** for each filter selection.
- Click **Search**.
- To search a new item, click **Reset** to reset the dialog box to its original blank state.

Setting up VCS event notification by using the Notifier wizard

The information presented in this topic assumes that you need to create both the ClusterService group and the Notifier resource. If the ClusterService group exists

but the Notifier resource is configured under another group, you can modify the attributes of the existing Notifier resource and system list for that group. If the ClusterService group is configured but the Notifier resource is not configured, the Notifier resource will be created and added to the ClusterService group.

To set up event notification by using the Notifier wizard

- 1 From Cluster Explorer, click **Notifier Wizard...** on the **Tools** menu.
or

On the Cluster Explorer toolbar, click **Launch Notifier Resource Configuration Wizard**.

- 2 Click **Next**.
- 3 In the Service Group Configuration for Notifier dialog box, do the following:
 - Enter the name of the notifier resource to be created. For example, "ntfr".
 - Click the target systems in the **Available Systems** box.
 - Click the right arrow to move the systems to the **Systems for Service Group** table. To remove a system from the table, click the system and click the left arrow.
 - Select the **Startup** check box to add the systems to the service groups AutoStartList attribute. This enables the service group to automatically come online on a system every time HAD is started.
 - The priority number (starting with 0) is assigned to indicate the order of systems on which the service group will start in case of a failover. If necessary, double-click the entry in the **Priority** column to enter a new value.
- 4 Click **Next**.

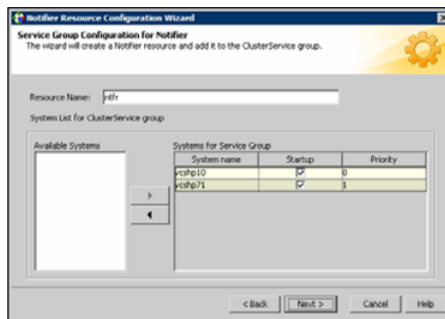

- 5 Choose the mode of notification that needs to be configured. Select the check boxes to configure SNMP and/or SMTP (if applicable).

- 6 In the SNMP Configuration dialog box (if applicable), do the following:
 - Click + to create the appropriate number of fields for the SNMP consoles and severity levels. Click - to remove a field.
 - Enter the console and click the severity level from the menu. For example, "snmpserv" and "Information".
 - Enter the SNMP trap port. For example, "162" is the default value.
- 7 Click **Next**.

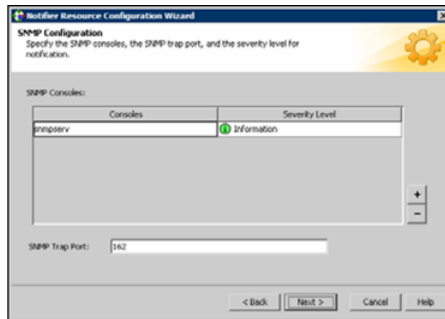

- 8 In the SMTP Configuration dialog box (if applicable), do the following:
 - Enter the name of the SMTP server.
 - Click + to create the appropriate number of fields for recipients of the notification and severity levels. Click - to remove a field.
 - Enter the recipient and click the severity level in the drop-down list box. For example, "admin@example.com" and "Information".
- 9 Click **Next**.

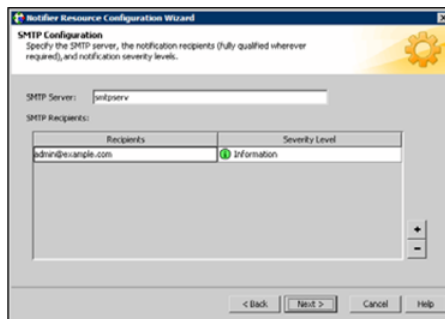

- 10 In the NIC Resource Configuration dialog box and do the following:

- Click **Configure NIC Resource** (recommended by Veritas) and proceed to the next step. Otherwise, click **Next**.
- If necessary, enter the name of the resource.
- Click the icon (...) in the **Discover** column of the table to find the MACAddress for each system.
- Click **OK** on the Discover dialog box.

11 Click **Next**.

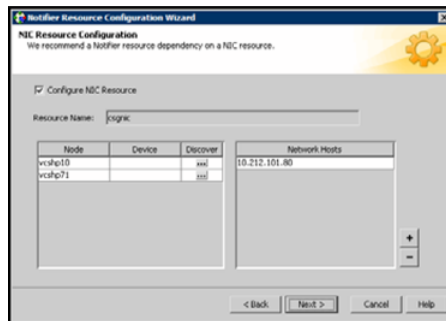

12 Click the **Bring the Notifier Resource Online** check box, if desired.

13 Click **Next**.

14 Click **Finish**.

Administering logs

The Java Console enables you to customize the log display of messages that the engine generates. In the Logs dialog box, you can set filter criteria to search and view messages, and monitor and resolve alert messages.

To view the VCS Log pop-up, select **View and Logs** from the drop-down menu or click **Show the Logs** from the toolbar.

To browse the logs for detailed views of each log message, double-click the event's description. Use the arrows in the **VCS Log details** pop-up window to navigate backward and forward through the message list.

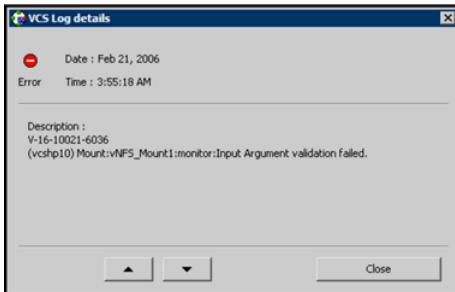

Customizing the log display

From the Logs dialog box, use the **Edit Filters** feature to customize the display of log messages.

To customize the display for VCS logs

- 1 In the **VCS Logs** tab, click **Edit Filters**.
- 2 Enter the filter criteria and do the following:
 - Click the types of logs to appear on the message display.
 - From the **Logs of** list, select the category of log messages to display.
 - From the **Named** menu, select the name of the selected object or component. To view all the messages for the selected category, click **All**.
 - In the **Logs from last** field, enter the numerical value and select the time unit.
 - To search log messages, enter the search string. Select the **Whole String** check box, if required.
- 3 Click **OK**.

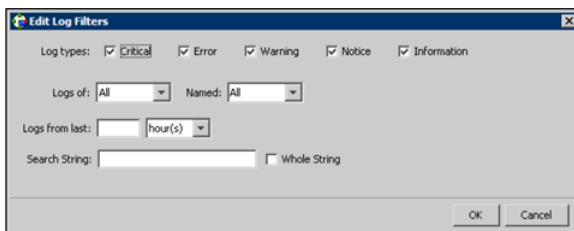

To customize the display for agent logs

- ◆ In the **Agent Logs** tab, enter the filter criteria and do the following:

- Click the name of the system.
- Enter the number of logs to view.
- Click the resource type.
- Click the name of the resource. To view messages for all resources, click **All**.
- Click **Get Logs**.

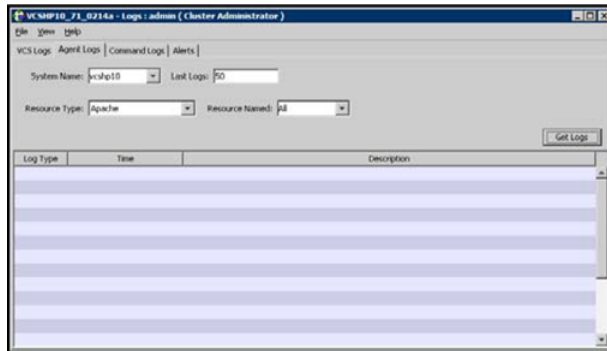

Resetting the log display

Use the **Reset Filters** feature to set the default settings for the log view. For example, if you customized the log view to only show critical and error messages by using the **Edit Filters** feature, the **Reset Filters** feature sets the view to show all log messages.

To reset the default settings for the log display

- ◆ In the **VCS Logs** tab, click **Reset Filters**.

Monitoring alerts

The Java Console sends automatic alerts that require administrative action and appear on the **Alerts** tab of the Logs dialog box. Use this tab to take action on the alert or delete the alert.

To take action on an alert

- 1 In the **Alert** tab or dialog box, click the alert to take action on.

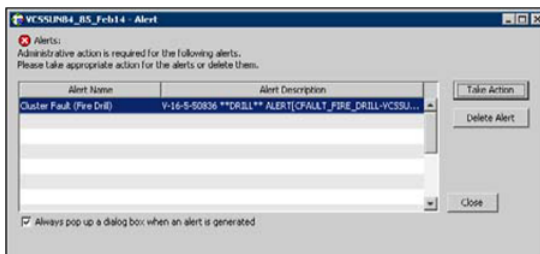

- 2 Click **Take Action**.
- 3 Enter the required information to resolve the alert.

If the alert warns that a local group cannot fail over to any system in the local cluster, you cannot take any action.

If the alert warns that a global group cannot fail over, the action involves bringing the group online on another system in the global cluster environment.

If the alert warns that a global cluster is faulted, the action involves declaring the cluster as a disaster, disconnect, or outage, and determining the service groups to fail over to another cluster.

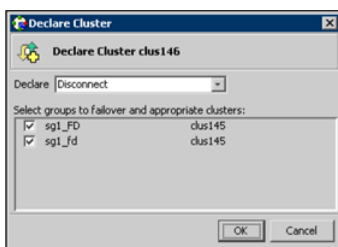

- 4 Click **OK**.

To delete an alert

- 1 In the **Alert** tab or dialog box, click the alert to delete.
- 2 Click **Delete Alert**.
- 3 Provide the details for this operation:
 - Enter the reason for deleting the alert.
 - Click **OK**.

Administering VCS Simulator

VCS Simulator, which can be installed on Windows systems, enables you to view state transitions, experiment with configuration parameters, and predict how service groups might behave during cluster or system faults. Use this tool to create and save configurations in an OFFLINE state.

Through the Java Console, VCS Simulator enables you to configure a simulated cluster panel, bring a system in an unknown state into an online state, simulate power loss for running systems, simulate resource faults, and save the configuration while VCS is offline.

For global clusters, you can simulate the process of generating and clearing cluster faults.

You can run multiple simulated clusters on a system by using different port numbers for each cluster. The Java Console provides the same views and features that are available for online configurations

See [“About VCS Simulator”](#) on page 300.

Administering the cluster from the command line

This chapter includes the following topics:

- [About administering VCS from the command line](#)
- [About installing a VCS license](#)
- [Administering LLT](#)
- [Administering the AMF kernel driver](#)
- [Starting VCS](#)
- [Stopping VCS](#)
- [Stopping the VCS engine and related processes](#)
- [Logging on to VCS](#)
- [About managing VCS configuration files](#)
- [About managing VCS users from the command line](#)
- [About querying VCS](#)
- [About administering service groups](#)
- [Administering agents](#)
- [About administering resources](#)
- [About administering resource types](#)
- [Administering systems](#)

- [About administering clusters](#)
- [Using the -wait option in scripts that use VCS commands](#)
- [Running HA fire drills](#)
- [About administering simulated clusters from the command line](#)

About administering VCS from the command line

Review the details on commonly used commands to administer VCS. For more information about specific commands or their options, see their usage information or the man pages associated with the commands.

You can enter most commands from any system in the cluster when VCS is running. The command to start VCS is typically initiated at system startup.

See [“VCS command line reference”](#) on page 754.

See [“About administering I/O fencing”](#) on page 358.

Symbols used in the VCS command syntax

[Table 6-1](#) specifies the symbols used in the VCS commands. Do not use these symbols when you run the commands.

Table 6-1 Symbols used in the VCS commands

Symbols	Usage	Example
[]	Used for command options or arguments that are optional.	hasys -freeze [-persistent] [-evacuate] <i>system</i>
	Used to specify that only one of the command options or arguments separated with can be used at a time.	hagetcf [-s -silent]
...	Used to specify that the argument can have several values.	hagr -modify group <i>attribute</i> value ... [-sys <i>system</i>]
{ }	Used to specify that the command options or arguments enclosed within these braces must be kept together.	haatr -display {cluster group system heartbeat <restype>} haclus -modify <i>attribute</i> { <i>key value</i> }

Table 6-1 Symbols used in the VCS commands (*continued*)

Symbols	Usage	Example
<>	Used in the command help or usage output to specify that these variables must be replaced with the actual values.	haclus -help VCS INFO V-16-1-10601 Usage: haclus -add <cluster> <ip> haclus -delete <cluster>

See [“About administering VCS from the command line”](#) on page 174.

How VCS identifies the local system

VCS checks the file `$VCS_CONF/conf/sysname`. If this file does not exist, the local system is identified by its node name. To view the system’s node name, type:

```
# uname -n
```

The entries in this file must correspond to those in the files `/etc/llthosts` and `/etc/llttab`.

About specifying values preceded by a dash (-)

When you specify values in a command-line syntax, you must prefix values that begin with a dash (-) with a percentage sign (%). If a value begins with a percentage sign, you must prefix it with another percentage sign. (The initial percentage sign is stripped by the High Availability Daemon (HAD) and does not appear in the configuration file.)

About the -modify option

Most configuration changes are made by using the `-modify` options of the commands `haclus`, `hagrp`, `hares`, `hasys`, and `hatype`. Specifically, the `-modify` option of these commands changes the attribute values that are stored in the VCS configuration file. By default, all attributes are global, meaning that the value of the attribute is the same for all systems.

Note: VCS must be in read-write mode before you can change the configuration.

See [“Setting the configuration to read or write”](#) on page 197.

Encrypting VCS passwords

Use the `vcseencrypt` utility to encrypt passwords when you edit the VCS configuration file `main.cf` to add VCS users.

Note: Do not use the `vcseencrypt` utility when you enter passwords from the Java console.

To encrypt a password

- 1 Run the utility from the command line.

```
# vcseencrypt -vcs
```

- 2 The utility prompts you to enter the password twice. Enter the password and press Return.

```
Enter Password:  
Enter Again:
```

- 3 The utility encrypts the password and displays the encrypted password. Use this password to edit the VCS configuration file `main.cf`.

Encrypting agent passwords

Use the `vcseencrypt` utility to encrypt passwords when you edit the VCS configuration file `main.cf` when you configure agents that require user passwords.

See [“Encrypting agent passwords by using security keys”](#) on page 177.

Note: Do not use the `vcseencrypt` utility when you enter passwords from the Java console.

To encrypt an agent password

- 1 Run the utility from the command line.

```
vcseencrypt -agent
```

- 2 The utility prompts you to enter the password twice. Enter the password and press Return.

```
Enter New Password:
```

```
Enter Again:
```

- 3 The utility encrypts the password and displays the encrypted password. Use this password to edit the VCS configuration file `main.cf`.

Encrypting agent passwords by using security keys

Encrypting the agent password using security keys involves the following steps:

- Generating the security key
- Encrypting the agent password

See [“Encrypting agent passwords”](#) on page 176.

Generating a security key

Use the `vcsecrypt` utility to generate a security key.

Note: You must be a root user or must have administrative privileges to generate the security keys.

To generate a security key, perform the following steps on any cluster node:

- 1 Make the VCS configuration writable.

```
# haconf -makerw
```

- 2 Run the `vcsecrypt` utility.

```
# vcsecrypt -gensecinfo
```

- 3 When prompted enter any pass phrase, having at least eight characters.

The utility generates the security key and displays the following message:

```
Generating SecInfo...please wait...
SecInfo generated successfully.
Trying to update its value in config file...
SecInfo updated successfully.
```

- 4 Save the VCS configuration and make it read only.

```
# haconf -dump -makero
```

Encrypting the agent password

To encrypt the agent password, perform the following steps on any cluster node:

- 1 Make the VCS configuration writable.

```
# haconf -makerw
```

- 2 Encrypt the agent password.

```
# vcsencrypt -agent -secinfo
```

- 3 When prompted, enter the existing password and press Enter.

The utility encrypts the entered password and displays the encrypted password.

For example, 7c:a7:4d:75:78:86:07:5a:de:9d:7a:9a:8c:6e:53:c6

- 4 Modify the required agent attribute to assign the encrypted password.

```
c:\>hares -modify <ResourceName>
        <password_attribute_name> <AES Password>
```

Granting password encryption privileges to group administrators

This procedure describes how to grant password encryption privileges to group administrators.

To grant password encryption privileges to group administrators

- ◆ Set the value of the cluster attribute SecInfoLevel to R+A:

```
# haclus -modify SecInfoLevel R+A
```

To restrict password encryption privileges to superusers

- ◆ Set the value of the cluster attribute SecInfoLevel to R:

```
# haclus -modify SecInfoLevel R
```

Changing the security key

Follow these instructions to change the security key.

If you change the security key, make sure that you re-encrypt all the passwords that you created with the new security key. Otherwise, the agent fails to decrypt the encrypted password which results in failure of resources monitoring.

To change security key

- 1 Save the VCS configuration and make it writeable.

```
# haconf -makerw
```

- 2 Run the following command:

```
# vcsencrypt -gensecinfo -force
```

- 3 Save the VCS configuration and make it read only.

```
# haconf -dump -makero
```

See [“Encrypting agent passwords”](#) on page 176.

About installing a VCS license

The Veritas InfoScale installer prompts you to select one of the following licensing methods:

- Install a license key for the product and features that you want to install. When you purchase a Veritas InfoScale product, you receive a License Key certificate. The certificate specifies the component keys and the type of license purchased.
- Continue to install without a license key. The installer prompts for the component options that you want to install, and then sets the required component level.

Within 60 days of choosing this option, you must install a valid license key corresponding to the license level entitled or continue with keyless licensing by managing the server or cluster with a management server.

Installing and updating license keys using vxlicinst

Use the `vxlicinst` command to install or update a valid product license key for the product you have purchased. See the `vxlicinst(1m)` manual page.

You must have root privileges to use this utility. This utility must be run on each system in the cluster; the utility cannot install or update a license on remote nodes.

To install a new license

- ◆ Run the following command on each node in the cluster:

```
# cd /opt/VRTS/bin
./vxlicinst -k XXXX-XXXX-XXXX-XXXX-XXXX-XXX
```

To update licensing information in a running cluster

- 1 Install the new component license on each node in the cluster using the `vxlicinst` utility.
- 2 Update system-level licensing information on all nodes in the cluster.

You must run the `updatelic` command only after you add a license key using the `vxlicinst` command or after you set the component license level using the `vxkeyless` command.

```
# hasys -updatelic -all
```

You must update licensing information on all nodes before proceeding to the next step.

- 3 Update cluster-level licensing information:

```
# haclus -updatelic
```

Setting or changing the product level for keyless licensing

Run the `vxkeyless` command to set the component level for the components you have purchased. This option also requires that you manage the server or cluster with a management server.

See the `vxkeyless(1m)` manual page.

To set or change the product level

- 1 View the current setting for the component level.

```
# vxkeyless [-v] display
```

- 2 View the possible settings for the component level.

```
# vxkeyless displayall
```

- 3 Set the desired component level.

```
# vxkeyless [-q] set prod_levels
```

Where *prod_levels* is a comma-separated list of keywords. Use the keywords returned by the `vxkeyless displayall` command.

If you want to remove keyless licensing and enter a key, you must clear the keyless licenses. Use the NONE keyword to clear all keys from the system.

Note that clearing the keys disables the components until you install a new key or set a new component level.

To clear the product license level

- 1 View the current setting for the component license level.

```
# vxkeyless [-v] display
```

- 2 If there are keyless licenses installed, remove all keyless licenses:

```
# vxkeyless [-q] set NONE
```

Administering LLT

You can use the LLT commands such as `lltdump` and `lltconfig` to administer the LLT links. See the corresponding LLT manual pages for more information on the commands.

See [“About Low Latency Transport \(LLT\)”](#) on page 46.

See [“Displaying the cluster details and LLT version for LLT links”](#) on page 182.

See [“Adding and removing LLT links”](#) on page 182.

See [“Configuring aggregated interfaces under LLT”](#) on page 184.

See [“Configuring destination-based load balancing for LLT”](#) on page 186.

Displaying the cluster details and LLT version for LLT links

You can use the `lltdump` command to display the LLT version for a specific LLT link. You can also display the cluster ID and node ID details.

See the `lltdump(1M)` manual page for more details.

To display the cluster details and LLT version for LLT links

- ◆ Run the following command to display the details:

```
# /opt/VRTSllt/lltdump -D -f link
```

For example, if `en3` is connected to `sys1`, then the command displays a list of all cluster IDs and node IDs present on the network link `en3`.

```
# /opt/VRTSllt/lltdump -D -f /dev/dlpi/en:3
```

```
lltdump : Configuration:

device : en3

sap : 0xcafe
promisc sap : 0
promisc mac : 0
cidsnoop : 1
=== Listening for LLT packets ===
cid nid vmaj vmin
3456 1 5 0
3456 3 5 0
83 0 4 0
27 1 3 7
3456 2 5 0
```

Adding and removing LLT links

You can use the `lltconfig` command to add or remove LLT links when LLT is running.

See the `lltconfig(1M)` manual page for more details.

Note: When you add or remove LLT links, you need not shut down GAB or the high availability daemon, `had`. Your changes take effect immediately, but are lost on the next restart. For changes to persist, you must also update the `/etc/llttab` file.

To add LLT links

- ◆ Depending on the LLT link type, run the following command to add an LLT link:

- For ether link type:

```
# lltconfig -t devtag -d device
[-b ether ] [-s SAP] [-m mtu] [-I] [-Q]
```

- For UDP link type:

```
# lltconfig -t devtag -d device
-b udp [-s port] [-m mtu]
-I IPaddr -B bcast
```

- For UDP6 link type:

```
# lltconfig -t devtag -d device
-b udp6 [-s port] [-m mtu]
-I IPaddr [-B mcast]
```

Where:

devtag	Tag to identify the link
device	Network device path of the interface For link type ether, the path is followed by a colon (:) and an integer which specifies the unit or PPA used by LLT to attach. For link types udp and udp6, the device is the udp and udp6 device path respectively.
bcast	Broadcast address for the link type udp and rdma
mcast	Multicast address for the link type udp6
IPaddr	IP address for link types udp, udp6 and rdma
SAP	SAP to bind on the network links for link type ether
port	Port for link types udp, udp6 and rdma
mtu	Maximum transmission unit to send packets on network links

For example:

- For ether link type:

```
# lltconfig -t en3 -d /dev/dlpi/en:3 -s 0xcafe -m 1500
```

- For UDP link type:

```
# lltconfig -t link1 -d /dev/xti/udp -b udp -s 50010  
-I 192.168.1.1 -B 192.168.1.255
```

- For UDP6 link type:

```
# lltconfig -t link1 -d /dev/xti/udp6  
-b udp6 -s 50010 -I 2000::1
```

Note: If you want the addition of LLT links to be persistent after reboot, then you must edit the `/etc/lltab` with LLT entries.

To remove an LLT link

- 1 Run the following command to disable a network link that is configured under LLT.

```
# lltconfig -t devtag -L disable
```

- 2 Wait for the 16 seconds (LLT peerinact time).
- 3 Run the following command to remove the link.

```
# lltconfig -u devtag
```

Configuring aggregated interfaces under LLT

If you want to configure LLT to use aggregated interfaces after installing and configuring VCS, you can use one of the following approaches:

- Edit the `/etc/lltab` file
This approach requires you to stop LLT. The aggregated interface configuration is persistent across reboots.
- Run the `lltconfig` command
This approach lets you configure aggregated interfaces on the fly. However, the changes are not persistent across reboots.

To configure aggregated interfaces under LLT by editing the `/etc/lltab` file

- 1 If LLT is running, stop LLT after you stop the other dependent modules.

```
# /etc/init.d/llt.rc stop
```

See “[Stopping VCS](#)” on page 189.

- 2 Add the following entry to the `/etc/llttab` file to configure an aggregated interface.

```
link tag device_name systemid_range link_type sap mtu_size
```

<code>tag</code>	Tag to identify the link
<code>device_name</code>	Network device path of the aggregated interface The path is followed by a colon (:) and an integer which specifies the unit or PPA used by LLT to attach.
<code>systemid_range</code>	Range of systems for which the command is valid. If the link command is valid for all systems, specify a dash (-).
<code>link_type</code>	The link type must be ether.
<code>sap</code>	SAP to bind on the network links. Default is 0xcafe.
<code>mtu_size</code>	Maximum transmission unit to send packets on network links

- 3 Restart LLT for the changes to take effect. Restart the other dependent modules that you stopped in step 1.

```
# /etc/init.d/llt.rc start
```

See “[Starting VCS](#)” on page 188.

To configure aggregated interfaces under LLT using the `lltconfig` command

- ◆ When LLT is running, use the following command to configure an aggregated interface:

```
lltconfig -t devtag -d device  
[-b linktype ] [-s SAP] [-m mtu]
```

devtag	Tag to identify the link
device	Network device path of the aggregated interface The path is followed by a colon (:) and an integer which specifies the unit or PPA used by LLT to attach.
link_type	The link type must be ether.
sap	SAP to bind on the network links. Default is 0xcafe.
mtu_size	Maximum transmission unit to send packets on network links

See the `lltconfig(1M)` manual page for more details.

You need not reboot after you make this change. However, to make these changes persistent across reboot, you must update the `/etc/llttab` file.

See [“To configure aggregated interfaces under LLT by editing the `/etc/llttab` file”](#) on page 184.

Configuring destination-based load balancing for LLT

Destination-based load balancing for Low Latency Transport (LLT) is turned off by default. Veritas recommends destination-based load balancing when the cluster setup has more than two nodes and more active LLT ports.

See [“About Low Latency Transport \(LLT\)”](#) on page 311.

To configure destination-based load balancing for LLT

- ◆ Run the following command to configure destination-based load balancing:

```
lltconfig -F linkburst:0
```

Administering the AMF kernel driver

Review the following procedures to start, stop, or unload the AMF kernel driver.

See [“About the IMF notification module”](#) on page 47.

See [“Environment variables to start and stop VCS modules”](#) on page 78.

To start the AMF kernel driver

- 1 Set the value of the `AMF_START` variable to 1 in the following file, if the value is not already 1:

```
# /etc/default/amf
```

- 2 Start the AMF kernel driver. Run the following command:

```
# /etc/init.d/amf.rc start
```

To stop the AMF kernel driver

- 1 Set the value of the `AMF_STOP` variable to 1 in the following file, if the value is not already 1:

```
# /etc/default/amf
```

- 2 Stop the AMF kernel driver. Run the following command:

```
# /etc/init.d/amf.rc stop
```

To unload the AMF kernel driver

- 1 If agent downtime is not a concern, use the following steps to unload the AMF kernel driver:
 - Stop the agents that are registered with the AMF kernel driver.
The `amfstat` command output lists the agents that are registered with AMF under the Registered Reapers section.
See the `amfstat` manual page.
 - Stop the AMF kernel driver.
See [“To stop the AMF kernel driver”](#) on page 187.
 - Start the agents.
- 2 If you want minimum downtime of the agents, use the following steps to unload the AMF kernel driver:
 - Run the following command to disable the AMF driver even if agents are still registered with it.

```
# amfconfig -Uof
```

- Stop the AMF kernel driver.

See [“To stop the AMF kernel driver”](#) on page 187.

Starting VCS

You can start VCS using one of the following approaches:

- Using the `installvcs -start` command
- Manually start VCS on each node

To start VCS

- 1 To start VCS using the `installvcs` program, perform the following steps on any node in the cluster:

- Log in as root user.
- Run the following command:

```
# /opt/VRTS/install/installvcs -start
```

- 2 To start VCS manually, run the following commands on each node in the cluster:

- Log in as root user.
- Start LLT and GAB. Start I/O fencing if you have configured it. Skip this step if you want to start VCS on a single-node cluster. Optionally, you can start AMF if you want to enable intelligent monitoring.

```
LLT          # /etc/init.d/llt.rc start
```

```
GAB          # /etc/init.d/gab.rc start
```

```
I/O fencing  # /etc/init.d/vxfen.rc start
```

```
AMF          # /etc/init.d/amf.rc start
```

- Start the VCS engine.

```
# hstart
```

To start VCS in a single-node cluster, run the following command:

```
# hstart -onode
```

See [“Starting the VCS engine \(HAD\) and related processes”](#) on page 189.

- 3 Verify that the VCS cluster is up and running.

```
# gabconfig -a
```

Make sure that port a and port h memberships exist in the output for all nodes in the cluster. If you configured I/O fencing, port b membership must also exist.

Starting the VCS engine (HAD) and related processes

The command to start VCS is invoked from the following file:

```
/etc/init.d/vcs.rc
```

When VCS is started, it checks the state of its local configuration file and registers with GAB for cluster membership. If the local configuration is valid, and if no other system is running VCS, it builds its state from the local configuration file and enters the RUNNING state.

If the configuration on all nodes is invalid, the VCS engine waits for manual intervention, or for VCS to be started on a system that has a valid configuration.

See [“System states”](#) on page 760.

To start the VCS engine

- ◆ Run the following command:

```
# hstart
```

To start the VCS engine when all systems are in the ADMIN_WAIT state

- ◆ Run the following command from any system in the cluster to force VCS to use the configuration file from the system specified by the variable system:

```
# hasys -force system
```

To start VCS on a single-node cluster

- ◆ Type the following command to start an instance of VCS that does not require GAB and LLT. Do not use this command on a multisystem cluster.

```
# hstart -onenode
```

Stopping VCS

You can stop VCS using one of the following approaches:

- Using the `installvcs -stop` command
- Manually stop VCS on each node

To stop VCS

- 1 To stop VCS using the `installvcs` program, perform the following steps on any node in the cluster:

- Log in as root user.
- Run the following command:

```
# /opt/VRTS/install/installvcs -stop
```

- 2 To stop VCS manually, run the following commands on each node in the cluster:

- Log in as root user.
- Take the VCS service groups offline and verify that the groups are offline.

```
# hagrps -offline service_group -sys system
```

```
# hagrps -state service_group
```

- Stop the VCS engine.

```
# hastop -local
```

See [“Stopping the VCS engine and related processes”](#) on page 191.

- Verify that the VCS engine port `h` is closed.

```
# gabconfig -a
```

- Stop I/O fencing if you have configured it. Stop GAB and then LLT.

```
I/O fencing      # /etc/init.d/vxfen.rc stop
```

```
GAB              # /etc/init.d/gab.rc stop
```

```
LLT              # /etc/init.d/llt.rc stop
```

Stopping the VCS engine and related processes

The `hastop` command stops the High Availability Daemon (HAD) and related processes. You can customize the behavior of the `hastop` command by configuring the `EngineShutdown` attribute for the cluster.

See [“About controlling the hastop behavior by using the EngineShutdown attribute”](#) on page 192.

The `hastop` command includes the following options:

```
hastop -all [-force]
hastop [-help]
hastop -local [-force | -evacuate | -noautodisable]
hastop -sys system ... [-force | -evacuate -noautodisable]
```

[Table 6-2](#) shows the options for the `hastop` command.

Table 6-2 Options for the `hastop` command

Option	Description
<code>-all</code>	Stops HAD on all systems in the cluster and takes all service groups offline.
<code>-help</code>	Displays the command usage.
<code>-local</code>	Stops HAD on the system on which you typed the command
<code>-force</code>	Allows HAD to be stopped without taking service groups offline on the system. The value of the <code>EngineShutdown</code> attribute does not influence the behavior of the <code>-force</code> option.
<code>-evacuate</code>	When combined with <code>-local</code> or <code>-sys</code> , migrates the system's active service groups to another system in the cluster, before the system is stopped.
<code>-noautodisable</code>	Ensures the service groups that can run on the node where the <code>hastop</code> command was issued are not autodisable. This option can be used with <code>-evacuate</code> but not with <code>-force</code> .
<code>-sys</code>	Stops HAD on the specified system.

About stopping VCS without the `-force` option

When VCS is stopped on a system without using the `-force` option, it enters the LEAVING state, and waits for all groups to go offline on the system. Use the output of the command `hasys -display system` to verify that the values of the `SysState`

and the OnGrpCnt attributes are non-zero. VCS continues to wait for the service groups to go offline before it shuts down.

See [“Troubleshooting resources”](#) on page 719.

About stopping VCS with options other than the `-force` option

When VCS is stopped by options other than `-force` on a system with online service groups, the groups that run on the system are taken offline and remain offline. VCS indicates this by setting the attribute `IntentOnline` to 0. Use the option `-force` to enable service groups to continue being online while the VCS engine (HAD) is brought down and restarted. The value of the `IntentOnline` attribute remains unchanged after the VCS engine restarts.

About controlling the `hastop` behavior by using the `EngineShutdown` attribute

Use the `EngineShutdown` attribute to define VCS behavior when a user runs the `hastop` command.

Note: VCS does not consider this attribute when the `hastop` is issued with the following options: `-force` or `-local -evacuate -noautodisable`.

Configure one of the following values for the attribute depending on the desired functionality for the `hastop` command:

[Table 6-3](#) shows the engine shutdown values for the attribute.

Table 6-3 Engine shutdown values

EngineShutdown Value	Description
Enable	Process all <code>hastop</code> commands. This is the default behavior.
Disable	Reject all <code>hastop</code> commands.
DisableClusStop	Do not process the <code>hastop -all</code> command; process all other <code>hastop</code> commands.
PromptClusStop	Prompt for user confirmation before you run the <code>hastop -all</code> command; process all other <code>hastop</code> commands.
PromptLocal	Prompt for user confirmation before you run the <code>hastop -local</code> command; process all other <code>hastop</code> commands except <code>hastop -sys</code> command.

Table 6-3 Engine shutdown values (*continued*)

EngineShutdown Value	Description
PromptAlways	Prompt for user confirmation before you run any <code>hastop</code> command.

Additional considerations for stopping VCS

Following are some additional considerations for stopping VCS:

- If you use the command `reboot`, behavior is controlled by the `ShutdownTimeOut` parameter. After HAD exits, if GAB exits within the time designated in the `ShutdownTimeout` attribute, the remaining systems recognize this as a reboot and fail over service groups from the departed system. For systems that run several applications, consider increasing the value of the `ShutdownTimeout` attribute.
- If you stop VCS on a system by using the `hastop` command, it autodisables each service group that includes the system in their `SystemList` attribute. VCS does not initiate online of the servicegroup when in an autodisable state. (This does not apply to systems that are powered off)
- If you use the `-evacuate` option, evacuation occurs before VCS is brought down. But when there are dependencies between the service groups while `-evacuate` command is issued, VCS rejects the command

Logging on to VCS

VCS prompts for user name and password information when non-root users run `haxxx` commands. Use the `halogin` command to save the authentication information so that you do not have to enter your credentials every time you run a VCS command. Note that you may need specific privileges to run VCS commands.

When you run the `halogin` command, VCS stores encrypted authentication information in the user's home directory. For clusters that run in secure mode, the command also sets up a trust relationship and retrieves a certificate from an authentication broker.

If you run the command for different hosts, VCS stores authentication information for each host. After you run the command, VCS stores the information until you end the session.

For clusters that run in secure mode, you also can generate credentials for VCS to store the information for 24 hours or for eight years and thus configure VCS to not prompt for passwords when you run VCS commands as non-root users.

See [“Running high availability commands \(HA\) commands as non-root users on clusters in secure mode”](#) on page 195.

Root users do not need to run `halogin` when running VCS commands from the local host.

To log on to a cluster running in secure mode

- 1 Set the following environment variables:
 - `VCS_DOMAIN`—Name of the Security domain to which the user belongs.
 - `VCS_DOMAINTYPE`—Type of VxSS domain: `unixpwd`, `nt`, `ldap`, `nis`, `nisplus`, or `vx`.
- 2 Define the node on which the VCS commands will be run. Set the `VCS_HOST` environment variable to the name of the node. To run commands in a remote cluster, you set the variable to the virtual IP address that was configured in the ClusterService group.

- 3 Log on to VCS:

```
# halogin vcsusername password
```

To log on to a cluster not running in secure mode

- 1 Define the node on which the VCS commands will be run. Set the `VCS_HOST` environment variable to the name of the node on which to run commands. To run commands in a remote cluster, you can set the variable to the virtual IP address that was configured in the ClusterService group.
- 2 Log on to VCS:

```
# halogin vcsusername password
```

To end a session for a host

- ◆ Run the following command:

```
# halogin -endsession hostname
```

To end all sessions

- ◆ Run the following command:

```
# halogin -endallsessions
```

After you end a session, VCS prompts you for credentials every time you run a VCS command.

Running high availability commands (HA) commands as non-root users on clusters in secure mode

Perform the following procedure to configure VCS to not prompt for passwords when a non-root user runs HA commands on a cluster which runs in secure mode.

To run HA commands as non-root users on clusters in secure mode

When a non-root user logs in, the logged in user context is used for HA commands, and no password is prompted. For example, if user *sam* has logged in to the host *@example.com*, and if VCS configuration specifies *sam@example.com* as the group administrator for group G1, then the non-root user gets administrative privileges for group G1.

- ◆ Run any HA command. This step generates credentials for VCS to store the authentication information. For example, run the following command:

```
# hasys -state
```

About managing VCS configuration files

This section describes how to verify, back up, and restore VCS configuration files.

See [“About the main.cf file”](#) on page 63.

See [“About the types.cf file”](#) on page 67.

About multiple versions of .cf files

When hacf creates a .cf file, it does not overwrite existing .cf files. A copy of the file remains in the directory, and its name includes a suffix of the date and time it was created, such as *main.cf.03Dec2001.17.59.04*. In addition, the previous version of any .cf file is saved with the suffix *.previous*; for example, *main.cf.previous*.

Verifying a configuration

Use hacf to verify (check syntax of) the *main.cf* and the type definition file, *types.cf*. VCS does not run if hacf detects errors in the configuration.

To verify a configuration

- ◆ Run the following command:

```
# hacf -verify config_directory
```

The variable *config_directory* refers to directories containing a main.cf file and any .cf files included in main.cf.

No error message and a return value of zero indicates that the syntax is legal.

Scheduling automatic backups for VCS configuration files

Configure the BackupInterval attribute to instruct VCS to create a back up of the configuration periodically. VCS backs up the main.cf and types.cf files as main.cf.autobackup and types.cf.autobackup, respectively.

To start periodic backups of VCS configuration files

- ◆ Set the cluster-level attribute BackupInterval to a non-zero value.

For example, to back up the configuration every 5 minutes, set BackupInterval to 5.

Example:

```
# haclus -display | grep BackupInterval
```

```
BackupInterval          0
```

```
# haconf -makerw
```

```
# haclus -modify BackupInterval 5
```

```
# haconf -dump -makero
```

Saving a configuration

When you save a configuration, VCS renames the file main.cf.autobackup to main.cf. VCS also save your running configuration to the file main.cf.autobackup.

If have not configured the BackupInterval attribute, VCS saves the running configuration.

See [“Scheduling automatic backups for VCS configuration files”](#) on page 196.

To save a configuration

- ◆ Run the following command

```
# haconf -dump -makero
```

The option `-makero` sets the configuration to read-only.

Setting the configuration to read or write

This topic describes how to set the configuration to read/write.

To set the mode to read or write

- ◆ Type the following command:

```
# haconf -makerw
```

Displaying configuration files in the correct format

When you manually edit VCS configuration files (for example, the `main.cf` or `types.cf` file), you create formatting issues that prevent the files from being parsed correctly.

To display the configuration files in the correct format

- ◆ Run the following commands to display the configuration files in the correct format:

```
# hacf -cftocmd config
# hacf -cmdtocf config
```

About managing VCS users from the command line

You can add, modify, and delete users on any system in the cluster, provided you have the privileges to do so.

If VCS is running in secure mode, specify user names, in one of the following formats:

- `username@domain`
- `username`

Specify only the user name to assign cluster-level privileges to a user. The user can access any node in the cluster. Privileges for a cluster-level user are the same across nodes in the cluster.

Specify the user name and the domain name to add a user on multiple nodes in the cluster. This option requires multiple entries for a user, one for each node.

You cannot assign or change passwords for users when VCS is running in secure mode.

The commands to add, modify, and delete a user must be executed only as root or administrator and only if the VCS configuration is in read/write mode.

See [“Setting the configuration to read or write”](#) on page 197.

Note: You must add users to the VCS configuration to monitor and administer VCS from the graphical user interface Cluster Manager.

Adding a user

Users in the category Cluster Guest cannot add users.

To add a user

- 1 Set the configuration to read/write mode:

```
# haconf -makerw
```

- 2 Add the user:

```
# hauser -add user [-priv <Administrator|Operator> [-group  
service_groups]]
```

- 3 Enter a password when prompted.
- 4 Reset the configuration to read-only:

```
# haconf -dump -makero
```

To add a user with cluster administrator access

- ◆ Type the following command:

```
# hauser -add user -priv Administrator
```

To add a user with cluster operator access

- ◆ Type the following command:

```
# hauser -add user -priv Operator
```

To add a user with group administrator access

- ◆ Type the following command:

```
# hauser -add user -priv Administrator -group service_groups
```

To add a user with group operator access

- ◆ Type the following command:

```
# hauser -add user -priv Operator -group service_groups
```

To add a user on only one node with cluster administrator access

- 1 Set the configuration to read/write mode:

```
# haconf -makerw
```

- 2 Add the user:

```
# hauser -add user@node.domain -priv Administrator
```

For example,

```
# hauser -add user1@sys1.domain1.com -priv Administrator
```

- 3 Reset the configuration to read-only:

```
# haconf -dump -makero
```

To add a user on only one node with group administrator access

- ◆ Type the following command:

```
# hauser -add user@node.domain -priv Administrator -group service_groups
```

Assigning and removing user privileges

The following procedure describes how to assign and remove user privileges:

To assign privileges to an administrator or operator

- ◆ Type the following command:

```
hauser -addpriv user Administrator|Operator  
[-group service_groups]
```

To remove privileges from an administrator or operator

- ◆ Type the following command:

```
hauser -delpriv user Administrator|Operator  
[-group service_groups]
```

To assign privileges to an OS user group

- ◆ Type the following command:

```
hauser -addpriv usergroup AdministratorGroup|OperatorGroup  
[-group service_groups]
```

To remove privileges from an OS user group

- ◆ Type the following command:

```
hauser -delpriv usergroup AdministratorGroup|OperatorGroup  
[-group service_groups]
```

Modifying a user

Users in the category Cluster Guest cannot modify users.

You cannot modify a VCS user in clusters that run in secure mode.

To modify a user

- 1 Set the configuration to read or write mode:

```
# haconf -makerw
```

- 2 Enter the following command to modify the user:

```
# hauser -update user
```

- 3 Enter a new password when prompted.

- 4 Reset the configuration to read-only:

```
# haconf -dump -makero
```

Deleting a user

You can delete a user from the VCS configuration.

To delete a user

- 1 Set the configuration to read or write mode:

```
# haconf -makerw
```

- 2 For users with Administrator and Operator access, remove their privileges:

```
# hauser -delpriv user Administrator|Operator [-group  
service_groups]
```

- 3 Delete the user from the list of registered users:

```
# hauser -delete user
```

- 4 Reset the configuration to read-only:

```
# haconf -dump -makero
```

Displaying a user

This topic describes how to display a list of users and their privileges.

To display a list of users

- ◆ Type the following command:

```
# hauser -list
```

To display the privileges of all users

- ◆ Type the following command:

```
# hauser -display
```

To display the privileges of a specific user

- ◆ Type the following command:

```
# hauser -display user
```

About querying VCS

VCS enables you to query various cluster objects, including resources, service groups, systems, resource types, agents, clusters, and sites. You may execute commands from any system in the cluster. Commands to display information on

the VCS configuration or system states can be executed by all users: you do not need root privileges.

Querying service groups

This topic describes how to perform a query on service groups.

To display the state of a service group on a system

- ◆ Type the following command:

```
# hagrps -state [service_group] [-sys system]
```

To display the resources for a service group

- ◆ Type the following command:

```
# hagrps -resources service_group
```

To display a list of a service group's dependencies

- ◆ Type the following command:

```
# hagrps -dep [service_group]
```

To display a service group on a system

- ◆ Type the following command:

```
# hagrps -display [service_group] [-sys system]
```

If *service_group* is not specified, information regarding all service groups is displayed.

To display the attributes of a system

- ◆ Type the following command:

```
# hagrps -display [service_group]  
[-attribute attribute] [-sys system]
```

Note that system names are case-sensitive.

To display the value of a service group attribute

- ◆ Type the following command:

```
# hagrps -value service_group attribute
```

To forecast the target system for failover

- ◆ Use the following command to view the target system to which a service group fails over during a fault:

```
# hagrps -forecast service_group [-policy failoverpolicy value] [-verbose]
```

The policy values can be any one of the following values: Priority, RoundRobin, Load or BiggestAvailable.

Note: You cannot use the `-forecast` option when the service group state is in transition. For example, VCS rejects the command if the service group is in transition to an online state or to an offline state.

The `-forecast` option is supported only for failover service groups. In case of offline failover service groups, VCS selects the target system based on the service group's failover policy.

The BiggestAvailable policy is applicable only when the service group attribute Load is defined and cluster attribute Statistics is enabled.

The actual service group FailOverPolicy can be configured as any policy, but the forecast is done as though FailOverPolicy is set to BiggestAvailable.

Querying resources

This topic describes how to perform a query on resources.

To display a resource's dependencies

- ◆ Enter the following command:

```
# hares -dep resource
```

Note: If you use this command to query atleast resource dependency, the dependency is displayed as a normal 1-to-1 dependency.

To display information about a resource

- ◆ Enter the following command:

```
# hares -display resource
```

If `resource` is not specified, information regarding all resources is displayed.

To display resources of a service group

- ◆ Enter the following command:

```
# hares -display -group service_group
```

To display resources of a resource type

- ◆ Enter the following command:

```
# hares -display -type resource_type
```

To display resources on a system

- ◆ Enter the following command:

```
# hares -display -sys system
```

To display the value of a specific resource attribute

- ◆ Enter the following command:

```
# hares -value resource attribute
```

To display atleast resource dependency

- ◆ Enter the following command:

```
# hares -dep -atleast resource
```

The following is an example of the command output:

```
#hares -dep -atleast
#Group  Parent  Child
g1      res1     res2,res3,res5,res6 min=2
g1      res7     res8
```

Querying resource types

This topic describes how to perform a query on resource types.

To display all resource types

- ◆ Type the following command:

```
# hatype -list
```

To display resources of a particular resource type

- ◆ Type the following command:

```
# hatype -resources resource_type
```

To display information about a resource type

- ◆ Type the following command:

```
# hatype -display resource_type
```

If *resource_type* is not specified, information regarding all types is displayed.

To display the value of a specific resource type attribute

- ◆ Type the following command:

```
# hatype -value resource_type attribute
```

Querying agents

[Table 6-4](#) lists the run-time status for the agents that the `haagent -display` command displays.

Table 6-4 Run-time status for the agents

Run-time status	Definition
Faults	Indicates the number of agent faults within one hour of the time the fault began and the time the faults began.
Messages	Displays various messages regarding agent status.
Running	Indicates the agent is operating.
Started	Indicates the file is executed by the VCS engine (HAD).

To display the run-time status of an agent

- ◆ Type the following command:

```
# haagent -display [agent]
```

If *agent* is not specified, information regarding all agents appears.

To display the value of a specific agent attribute

- ◆ Type the following command:

```
# haagent -value agent attribute
```

Querying systems

This topic describes how to perform a query on systems.

To display a list of systems in the cluster

- ◆ Type the following command:

```
# hasys -list
```

To display information about each system

- ◆ Type the following command:

```
# hasys -display [system]
```

If you do not specify a system, the command displays attribute names and values for all systems.

To display the value of a specific system attribute

- ◆ Type the following command:

```
# hasys -value system attribute
```

To display system attributes related to resource utilization

- ◆ Use the following command to view the resource utilization of the following system attributes:
 - Capacity
 - HostAvailableForecast
 - HostUtilization

```
# hasys -util system
```

The `-util` option is applicable only if you set the cluster attribute `Statistics` to `Enabled` and define at least one key in the cluster attribute `HostMeters`.

The command also indicates if the `HostUtilization`, and `HostAvailableForecast` values are stale.

Querying clusters

This topic describes how to perform a query on clusters.

To display the value of a specific cluster attribute

- ◆ Type the following command:

```
# haclus -value attribute
```

To display information about the cluster

- ◆ Type the following command:

```
# haclus -display
```

Querying status

This topic describes how to perform a query on status of service groups in the cluster.

Note: Run the `hastatus` command with the `-summary` option to prevent an incessant output of online state transitions. If the command is used without the option, it will repeatedly display online state transitions until it is interrupted by the command CTRL+C.

To display the status of all service groups in the cluster, including resources

- ◆ Type the following command:

```
# hastatus
```

To display the status of a particular service group, including its resources

- ◆ Type the following command:

```
# hastatus [-sound] [-time] -group service_group  
[-group service_group]. . .
```

If you do not specify a service group, the status of all service groups appears. The `-sound` option enables a bell to ring each time a resource faults.

The `-time` option prints the system time at which the status was received.

To display the status of service groups and resources on specific systems

- ◆ Type the following command:

```
# hastatus [-sound] [-time] -sys system_name  
[-sys system_name]. . .
```

To display the status of specific resources

- ◆ Type the following command:

```
# hastatus [-sound] [-time] -resource resource_name
[-resource resource_name]
```

To display the status of cluster faults, including faulted service groups, resources, systems, links, and agents

- ◆ Type the following command:

```
# hastatus -summary
```

Querying log data files (LDFs)

Log data files (LDFs) contain data regarding messages written to a corresponding English language file. Typically, for each English file there is a corresponding LDF.

To display the hamsg usage list

- ◆ Type the following command:

```
# hamsg -help
```

To display the list of LDFs available on the current system

- ◆ Type the following command:

```
# hamsg -list
```

To display general LDF data

- ◆ Type the following command:

```
# hamsg -info [-path path_name] LDF
```

The option `-path` specifies where `hamsg` looks for the specified LDF. If not specified, `hamsg` looks for files in the default directory:

```
/var/VRTSvcs/ldf
```

To display specific LDF data

- ◆ Type the following command:

```
# hamsg [-any] [-sev C|E|W|N|I]
[-otype VCS|RES|GRP|SYS|AGT]
```

```
[-oname object_name] [-cat category] [-msgid message_ID]  
[-path path_name] [-lang language] LDF_file
```

-any	Specifies <code>hamsg</code> return messages that match any of the specified query options.
-sev	Specifies <code>hamsg</code> return messages that match the specified message severity Critical, Error, Warning, Notice, or Information.
-otype	Specifies <code>hamsg</code> return messages that match the specified object type <ul style="list-style-type: none">■ VCS = general VCS messages■ RES = resource■ GRP = service group■ SYS = system■ AGT = agent
-oname	Specifies <code>hamsg</code> return messages that match the specified object name.
-cat	Specifies <code>hamsg</code> return messages that match the specified category. For example, the value 2 in the message id "V-16-2-13067"
-msgid	Specifies <code>hamsg</code> return messages that match the specified message ID. For example, the value 13067 the message id "V-16-2-13067"
-path	Specifies where <code>hamsg</code> looks for the specified LDF. If not specified, <code>hamsg</code> looks for files in the default directory: <code>/var/VRTSvcs/ldf</code>
-lang	Specifies the language in which to display messages. For example, the value <code>en</code> specifies English and <code>"ja"</code> specifies Japanese.

Using conditional statements to query VCS objects

Some query commands include an option for conditional statements. Conditional statements take three forms:

`Attribute=Value` (the attribute equals the value)

`Attribute!=Value` (the attribute does not equal the value)

`Attribute=~Value` (the value is the prefix of the attribute, for example a query for the state of a resource = `~FAULTED` returns all resources whose state begins with `FAULTED`.)

Multiple conditional statements can be used and imply `AND` logic.

You can only query attribute-value pairs that appear in the output of the command `hagrp -display`.

See [“Querying service groups”](#) on page 202.

To display the list of service groups whose values match a conditional statement

- ◆ Type the following command:

```
# hagrp -list [conditional_statement]
```

If no conditional statement is specified, all service groups in the cluster are listed.

To display a list of resources whose values match a conditional statement

- ◆ Type the following command:

```
# hares -list [conditional_statement]
```

If no conditional statement is specified, all resources in the cluster are listed.

To display a list of agents whose values match a conditional statement

- ◆ Type the following command:

```
# haagent -list [conditional_statement]
```

If no conditional statement is specified, all agents in the cluster are listed.

About administering service groups

Administration of service groups includes tasks such as adding, deleting, or modifying service groups.

Adding and deleting service groups

This topic describes how to add or delete a service group.

To add a service group to your cluster

- ◆ Type the following command:

```
# hagr -add service_group
```

The variable *service_group* must be unique among all service groups defined in the cluster.

This command initializes a service group that is ready to contain various resources. To employ the group properly, you must populate its `SystemList` attribute to define the systems on which the group may be brought online and taken offline. (A system list is an association of names and integers that represent priority values.)

To delete a service group

- ◆ Type the following command:

```
# hagr -delete service_group
```

Note that you cannot delete a service group until all of its resources are deleted.

Modifying service group attributes

This topic describes how to modify service group attributes.

To modify a service group attribute

- ◆ Type the following command:

```
# hagrpx -modify service_group attribute value [-sys system]
```

The variable *value* represents:

```
system_name1 priority1 system_name2 priority2
```

If the attribute that is being modified has local scope, you must specify the system on which to modify the attribute, except when modifying the attribute on the system from which you run the command.

For example, to populate the system list of service group groupx with Systems A and B, type:

```
# hagrpx -modify groupx SystemList -add SystemA 1 SystemB 2
```

Similarly, to populate the AutoStartList attribute of a service group, type:

```
# hagrpx -modify groupx AutoStartList SystemA SystemB
```

You may also define a service group as parallel. To set the Parallel attribute to 1, type the following command. (Note that the default for this attribute is 0, which designates the service group as a failover group.):

```
# hagrpx -modify groupx Parallel 1
```

You cannot modify this attribute if resources have already been added to the service group.

You can modify the attributes SystemList, AutoStartList, and Parallel only by using the command `hagrpx -modify`. You cannot modify attributes created by the system, such as the state of the service group.

Modifying the SystemList attribute

You use the `hagrpx -modify` command to change a service group's existing system list, you can use the options `-modify`, `-add`, `-update`, `-delete`, or `-delete -keys`.

For example, suppose you originally defined the SystemList of service group groupx as SystemA and SystemB. Then after the cluster was brought up you added a new system to the list:

```
# hagrpx -modify groupx SystemList -add SystemC 3
```

You must take the service group offline on the system that is being modified.

When you add a system to a service group's system list, the system must have been previously added to the cluster. When you use the command line, you can use the `hasys -add` command.

When you delete a system from a service group's system list, the service group must not be online on the system to be deleted.

If you attempt to change a service group's existing system list by using `hagrp -modify` without other options (such as `-add` or `-update`) the command fails.

Bringing service groups online

This topic describes how to bring service groups online.

To bring a service group online

- ◆ Type one of the following commands:

```
# hagrp -online service_group -sys system

# hagrp -online service_group -site [site_name]
```

To start a service group on a system and bring online only the resources already online on another system

- ◆ Type the following command:

```
# hagrp -online service_group -sys system
-checkpartial other_system
```

If the service group does not have resources online on the other system, the service group is brought online on the original system and the `checkpartial` option is ignored.

Note that the `checkpartial` option is used by the Preonline trigger during failover. When a service group that is configured with `Preonline =1` fails over to another system (system 2), the only resources brought online on system 2 are those that were previously online on system 1 prior to failover.

To bring a service group and its associated child service groups online

- ◆ Type one of the following commands:

```
■ # hagrp -online -propagate service_group -sys system

■ # hagrp -online -propagate service_group -any

■ # hagrp -online -propagate service_group -site site
```

Note: See the man pages associated with the `hagrp` command for more information about the `-propagate` option.

Taking service groups offline

This topic describes how to take service groups offline.

To take a service group offline

- ◆ Type one of the following commands:

```
# hagrp -offline service_group -sys system
```

```
# hagrp -offline service_group -site site_name
```

To take a service group offline only if all resources are probed on the system

- ◆ Type the following command:

```
# hagrp -offline [-ifprobed] service_group -sys system
```

To take a service group and its associated parent service groups offline

- ◆ Type one of the following commands:

```
■ # hagrp -offline -propagate service_group -sys system
```

```
■ # hagrp -offline -propagate service_group -any
```

```
■ # hagrp -offline -propagate service_group -site site_name
```

Note: See the man pages associated with the `hagrp` command for more information about the `-propagate` option.

Switching service groups

The process of switching a service group involves taking it offline on its current system or site and bringing it online on another system or site.

To switch a service group from one system to another

- ◆ Type the following command:

```
# hagrps -switch service_group -to system  
  
# hagrps -switch service_group -site site_name
```

A service group can be switched only if it is fully or partially online. The `-switch` option is not supported for switching hybrid service groups across system zones.

Switch parallel global groups across clusters by using the following command:

```
# hagrps -switch service_group -any -clus remote_cluster
```

VCS brings the parallel service group online on all possible nodes in the remote cluster.

Migrating service groups

VCS provides live migration capabilities for service groups that have resources to monitor virtual machines. The process of migrating a service group involves concurrently moving the service group from the source system to the target system with minimum downtime.

To migrate a service group from one system to another

- ◆ Type the following command:

```
# hagrps -migrate service_group -to system
```

A service group can be migrated only if it is fully online. The `-migrate` option is supported only for failover service groups and for resource types that have the `SupportedOperations` attribute set to `migrate`.

See [“Resource type attributes”](#) on page 773.

The service group must meet the following requirements regarding configuration:

- A single mandatory resource that can be migrated, having the `SupportedOperations` attribute set to `migrate` and the `Operations` attribute set to `OnOff`
- Other optional resources with `Operations` attribute set to `None` or `OnOnly`

The `-migrate` option is supported for the following configurations:

- Stand alone service groups
- Service groups having one or both of the following configurations:

- Parallel child service groups with online local soft or online local firm dependencies
- Parallel or failover parent service group with online global soft or online remote soft dependencies

Freezing and unfreezing service groups

Freeze a service group to prevent it from failing over to another system. This freezing process stops all online and offline procedures on the service group.

Note that if the service group is in ONLINE state and if you freeze the service group, then the group continues to remain in ONLINE state.

Unfreeze a frozen service group to perform online or offline operations on the service group.

To freeze a service group (disable online, offline, and failover operations)

- ◆ Type the following command:

```
# hagrps -freeze service_group [-persistent]
```

The option `-persistent` enables the freeze to be remembered when the cluster is rebooted.

To unfreeze a service group (reenable online, offline, and failover operations)

- ◆ Type the following command:

```
# hagrps -unfreeze service_group [-persistent]
```

Enabling and disabling service groups

Enable a service group before you bring it online. A service group that was manually disabled during a maintenance procedure on a system may need to be brought online after the procedure is completed.

Disable a service group to prevent it from coming online. This process temporarily stops VCS from monitoring a service group on a system that is undergoing maintenance operations

To enable a service group

- ◆ Type the following command:

```
# hagrps -enable service_group [-sys system]
```

A group can be brought online only if it is enabled.

To disable a service group

- ◆ Type the following command:

```
# hagrps -disable service_group [-sys system]
```

A group cannot be brought online or switched if it is disabled.

To enable all resources in a service group

- ◆ Type the following command:

```
# hagrps -enableresources service_group
```

To disable all resources in a service group

- ◆ Type the following command:

```
# hagrps -disableresources service_group
```

Agents do not monitor group resources if resources are disabled.

Enabling and disabling priority based failover for a service group

This topic describes how to enable and disable priority based failover for a service group. Even though the priority based failover gets configured for all the service groups in a cluster, you must enable the feature at the cluster level.

To enable priority based failover of your service group

- Run the following command on the cluster:

```
# haclus -modify EnablePBF 1
```

This attribute enables Priority based failover for high priority service group.

During a failover, VCS checks the load requirement for the high-priority service group and evaluates the best available target that meets the load requirement. If none of the available systems meet the load requirement, then VCS checks for any lower priority groups that can be offlined to meet the load requirement.

VCS performs the following checks, before failing over the high-priority service group:

- Check the best target system that meets the load requirement of the high-priority service group.
- If no system meets the load requirement, create evacuation plan for each target system to see which system will have the minimum disruption.
- Evacuation plan consists of a list of low priority service groups that need to be taken offline to meet the load requirement. Disruption factor is calculated for the

system along with the evacuation plan. Disruption factor is based on the priority of the service groups that will be brought offline or evacuated. The following table shows the mapping of service group priority with the disruption factor:

Service group priority	Disruption factor
4	1
3	10
2	100
1	Will not be evacuated

- Choose the System with minimum disruption as the target system and execute evacuation plan. This initiates the offline of the low priority service groups. Plan is visible under attribute (Group::Evaclist) . After all the groups in the evacuation plan are offline, initiate online of high priority service group.

To disable priority based failover of your service group:

- Run the following command on the service group:

```
# haclus -modify EnablePBF 0
```

Note: This attribute cannot be modified when evacuation of a group is in progress.

Clearing faulted resources in a service group

Clear a resource to remove a fault and make the resource available to go online.

To clear faulted, non-persistent resources in a service group

- ◆ Type the following command:

```
# hagr -clear service_group [-sys system]
```

Clearing a resource initiates the online process previously blocked while waiting for the resource to become clear.

- If *system* is specified, all faulted, non-persistent resources are cleared from that system only.
- If *system* is not specified, the service group is cleared on all systems in the group's SystemList in which at least one non-persistent resource has faulted.

To clear resources in ADMIN_WAIT state in a service group

- ◆ Type the following command:

```
# hagr -clearadminwait [-fault] service_group -sys system
```

See “[Changing agent file paths and binaries](#)” on page 451.

Flushing service groups

When a service group is brought online or taken offline, the resources within the group are brought online or taken offline. If the online operation or offline operation hangs on a particular resource, flush the service group to clear the WAITING TO GO ONLINE or WAITING TO GO OFFLINE states from its resources. Flushing a service group typically leaves the service group in a partial state. After you complete this process, resolve the issue with the particular resource (if necessary) and proceed with starting or stopping the service group.

Note: The flush operation does not halt the resource operations (such as online, offline, migrate, and clean) that are running. If a running operation succeeds after a flush command was fired, the resource state might change depending on the operation.

Use the command `hagr -flush` to clear the internal state of VCS. The `hagr -flush` command transitions resource state from ‘waiting to go online’ to ‘not waiting’. You must use the `hagr -flush -force` command to transition resource state from ‘waiting to go offline’ to ‘not waiting’.

To flush a service group on a system

- ◆ Type the following command:

```
# hagr -flush [-force] group  
-sys system [-clus cluster | -localclus]
```

To flush all service groups on a system

- 1 Save the following script as `haflush` at the location `/opt/VRTSvcs/bin/`

```
#!/bin/ksh
PATH=/opt/VRTSvcs/bin:$PATH; export PATH
if [ $# -ne 1 ]; then
    echo "usage: $0 <system name>"
    exit 1
fi

hagr -list |
while read grp sys junk
do
    locsys="${sys##*:}"
    case "$locsys" in
        "$1")
            hagr -flush "$grp" -sys "$locsys"
            ;;
    esac
done
```

- 2 Run the script.

```
# haflush systemname
```

Linking and unlinking service groups

This topic describes how to link service groups to create a dependency between them.

See [“About service group dependencies”](#) on page 475.

To link service groups

- ◆ Type the following command

```
# hagrps -link parent_group child_group  
gd_category gd_location [gd_type]
```

parent_group Name of the parent group

child_group Name of the child group

gd_category Category of group dependency (online/offline).

gd_location The scope of dependency (local/global/remote/site).

gd_type Type of group dependency (soft/firm/hard). Default is firm.

To unlink service groups

- ◆ Type the following command:

```
# hagrps -unlink parent_group child_group
```

Administering agents

Under normal conditions, VCS agents are started and stopped automatically.

To start an agent

- ◆ Run the following command:

```
haagent -start agent -sys system
```

To stop an agent

- ◆ Run the following command:

```
haagent -stop agent [-force] -sys system
```

The `-force` option stops the agent even if the resources for the agent are online. Use the `-force` option when you want to upgrade an agent without taking its resources offline.

About administering resources

Administration of resources includes tasks such as adding, deleting, modifying, linking, unlinking, probing, and clearing resources, bringing resources online, and taking them offline.

About adding resources

When you add a resource, all non-static attributes of the resource's type, plus their default values, are copied to the new resource.

Three attributes are also created by the system and added to the resource:

- **Critical** (default = 1). If the resource or any of its children faults while online, the entire service group is marked faulted and failover occurs.
In an atleast resource set, the fault of a critical resource is tolerated until the minimum requirement associated with the resource set is met.
- **AutoStart** (default = 1). If the resource is set to AutoStart, it is brought online in response to a service group command. All resources designated as AutoStart=1 must be online for the service group to be considered online. (This attribute is unrelated to AutoStart attributes for service groups.)
- **Enabled**. If the resource is set to Enabled, the agent for the resource's type manages the resource. The default is 1 for resources defined in the configuration file `main.cf`, 0 for resources added on the command line.

Note: The addition of resources on the command line requires several steps, and the agent must be prevented from managing the resource until the steps are completed. For resources defined in the configuration file, the steps are completed before the agent is started.

Adding resources

This topic describes how to add resources to a service group or remove resources from a service group.

To add a resource

- ◆ Type the following command:

```
hares -add resource resource_type service_group
```

The resource name must be unique throughout the cluster. The resource type must be defined in the configuration language. The resource belongs to the group `service_group`.

Deleting resources

This topic describes how to delete resources from a service group.

To delete a resource

- ◆ Type the following command:

```
hares -delete resource
```

VCS does not delete online resources. However, you can enable deletion of online resources by changing the value of the DeleteOnlineResources attribute.

See “Cluster attributes” on page 831.

To delete a resource forcibly, use the `-force` option, which takes the resource offline irrespective of the value of the DeleteOnlineResources attribute.

```
hares -delete -force resource
```

Adding, deleting, and modifying resource attributes

Resource names must be unique throughout the cluster and you cannot modify resource attributes defined by the system, such as the resource state.

To modify a new resource

- ◆ Type the following command:

```
hares -modify resource attribute value
```

```
hares -modify resource attribute value  
[-sys system] [-wait [-time waittime]]
```

The variable *value* depends on the type of attribute being created.

To set a new resource’s Enabled attribute to 1

- ◆ Type the following command:

```
hares -modify resourceA Enabled 1
```

The agent managing the resource is started on a system when its Enabled attribute is set to 1 on that system. Specifically, the VCS engine begins to monitor the resource for faults. Agent monitoring is disabled if the Enabled attribute is reset to 0.

To add a resource attribute

- ◆ Type the following command:

```
haattr -add resource_type attribute  
[value] [dimension] [default ...]
```

The variable *value* is a -string (default), -integer, or -boolean.

The variable *dimension* is -scalar (default), -keylist, -assoc, or -vector.

The variable *default* is the default value of the attribute and must be compatible with the *value* and *dimension*. Note that this may include more than one item, as indicated by ellipses (...).

To delete a resource attribute

- ◆ Type the following command:

```
haattr -delete resource_type attribute
```

To add a static resource attribute

- ◆ Type the following command:

```
haattr -add -static resource_type static_attribute  
[value] [dimension] [default ...]
```

To delete a static resource attribute

- ◆ Type the following command:

```
haattr -delete -static resource_type static_attribute
```

To add a temporary resource attribute

- ◆ Type the following command:

```
haattr -add -temp resource_type attribute  
[value] [dimension] [default ...]
```

To delete a temporary resource attribute

- ◆ Type the following command:

```
haattr -delete -temp resource_type attribute
```

To modify the default value of a resource attribute

- ◆ Type the following command:

```
haattr -default resource_type attribute new_value ...
```

The variable *new_value* refers to the attribute's new default value.

Defining attributes as local

Localizing an attribute means that the attribute has a per-system value for each system listed in the group's SystemList. These attributes are localized on a per-resource basis. For example, to localize the attribute *attribute_name* for *resource* only, type:

```
hares -local resource attribute_name
```

Note that global attributes cannot be modified with the `hares -local` command.

[Table 6-5](#) lists the commands to be used to localize attributes depending on their dimension.

Table 6-5 Making VCS attributes local

Dimension	Task and Command
scalar	Replace a value: <pre>-modify [object] <i>attribute_name value [-sys system]</i></pre>
vector	<ul style="list-style-type: none"> ■ Replace list of values: <pre>-modify [object] <i>attribute_name value [-sys system]</i></pre> ■ Add list of values to existing list: <pre>-modify [object] <i>attribute_name -add value [-sys system]</i></pre> ■ Update list with user-supplied values: <pre>-modify [object] <i>attribute_name -update entry_value ... [-sys system]</i></pre> ■ Delete user-supplied values in list (if the list has multiple occurrences of the same value, then all the occurrences of the value is deleted): <pre>-modify [object] <i>attribute_name -delete <key> ... [-sys system]</i></pre> ■ Delete all values in list: <pre>-modify [object] <i>attribute_name -delete -keys [-sys system]</i></pre>

Table 6-5 Making VCS attributes local (*continued*)

Dimension	Task and Command
keylist	<ul style="list-style-type: none"> ■ Replace list of keys (duplicate keys not allowed): <code>-modify [object] attribute_name value ... [-sys system]</code> ■ Add keys to list (duplicate keys not allowed): <code>-modify [object] attribute_name -add value ... [-sys system]</code> ■ Delete user-supplied keys from list: <code>-modify [object] attribute_name -delete key ... [-sys system]</code> ■ Delete all keys from list: <code>-modify [object] attribute_name -delete -keys [-sys system]</code>
association	<ul style="list-style-type: none"> ■ Replace list of key-value pairs (duplicate keys not allowed): <code>-modify [object] attribute_name value ... [-sys system]</code> ■ Add user-supplied list of key-value pairs to existing list (duplicate keys not allowed): <code>-modify [object] attribute_name -add value ... [-sys system]</code> ■ Replace value of each key with user-supplied value: <code>-modify [object] attribute_name -update key value ... [-sys system]</code> ■ Delete a key-value pair identified by user-supplied key: <code>-modify [object] attribute_name -delete key ... [-sys system]</code> ■ Delete all key-value pairs from association: <code>-modify [object] attribute_name -delete -keys [-sys system]</code> <p>Note: If multiple values are specified and if one is invalid, VCS returns an error for the invalid value, but continues to process the others. In the following example, if sysb is part of the attribute SystemList, but sysa is not, sysb is deleted and an error message is sent to the log regarding sysa.</p> <pre>hagrp -modify group1 SystemList -delete sysa sysb [-sys system]</pre>

Defining attributes as global

Use the `hares -global` command to set a cluster-wide value for an attribute.

To set an attribute's value on all systems

- ◆ Type the following command:

```
# hares -global resource attribute
value ... | key... | {key value}...
```

Enabling and disabling intelligent resource monitoring for agents manually

Review the following procedures to enable or disable intelligent resource monitoring manually. The intelligent resource monitoring feature is enabled by default. The IMF resource type attribute determines whether an IMF-aware agent must perform intelligent resource monitoring.

See [“About resource monitoring”](#) on page 40.

See [“Resource type attributes”](#) on page 773.

To enable intelligent resource monitoring

- 1 Make the VCS configuration writable.

```
# haconf -makerw
```

- 2 Run the following command to enable intelligent resource monitoring.

- To enable intelligent monitoring of offline resources:

```
# hatype -modify resource_type IMF -update Mode 1
```

- To enable intelligent monitoring of online resources:

```
# hatype -modify resource_type IMF -update Mode 2
```

- To enable intelligent monitoring of both online and offline resources:

```
# hatype -modify resource_type IMF -update Mode 3
```

- 3 If required, change the values of the `MonitorFreq` key and the `RegisterRetryLimit` key of the IMF attribute.

See the *Cluster Server Bundled Agents Reference Guide* for agent-specific recommendations to set these attributes.

- 4 Save the VCS configuration.

```
# haconf -dump -makero
```

- 5 Make sure that the AMF kernel driver is configured on all nodes in the cluster.

```
/etc/init.d/amf.rc status
```

If the AMF kernel driver is configured, the output resembles:

```
AMF: Module loaded and configured
```

Configure the AMF driver if the command output returns that the AMF driver is not loaded or not configured.

See [“Administering the AMF kernel driver”](#) on page 186.

- 6 Restart the agent. Run the following commands on each node.

```
# haagent -stop agent_name -force -sys sys_name  
# haagent -start agent_name -sys sys_name
```

To disable intelligent resource monitoring

- 1 Make the VCS configuration writable.

```
# haconf -makerw
```

- 2 To disable intelligent resource monitoring for all the resources of a certain type, run the following command:

```
# hatype -modify resource_type IMF -update Mode 0
```

- 3 To disable intelligent resource monitoring for a specific resource, run the following command:

```
# hares -override resource_name IMF  
# hares -modify resource_name IMF -update Mode 0
```

- 4 Save the VCS configuration.

```
# haconf -dump -makero
```

Note: VCS provides `haimfconfig` script to enable or disable the IMF functionality for agents. You can use the script with VCS in running or stopped state. Use the script to enable or disable IMF for the IMF-aware bundled agents, enterprise agents, and custom agents.

See [“Enabling and disabling IMF for agents by using script”](#) on page 229.

Enabling and disabling IMF for agents by using script

VCS provides a script to enable and disable IMF for agents and for the AMF module. You can use the script when VCS is running or when VCS is stopped. Use the script to enable or disable IMF for the IMF-aware bundled agents, enterprise agents, and custom agents.

You must run the script once on each node of the cluster by using the same command. For example, if you enabled IMF for all IMF-aware agents on one node, you must repeat the action on the other cluster nodes too.

The following procedures describe how to enable or disable IMF for agents by using the script.

See [“About resource monitoring”](#) on page 40.

See [“Resource type attributes”](#) on page 773.

Enabling and disabling IMF for all IMF-aware agents

Enable or disable IMF for all IMF-aware agents as follows:

To enable IMF for all IMF-aware agents

- ◆ Run the following command:

```
haimfconfig -enable
```

To disable IMF for all IMF-aware agents

- ◆ Run the following command:

```
haimfconfig -disable
```

Note: The preceding `haimfconfig` commands cover all IMF-aware agents.

Enabling and disabling IMF for a set of agents

Enable or disable IMF for a set of agents as follows:

To enable IMF for a set of agents

- ◆ Run the following command:

```
haimfconfig -enable -agent agent(s)
```

This command enables IMF for the specified agents. It also configures and loads the AMF module on the system if the module is not already loaded. If the agent is a custom agent, the command prompts you for the `Mode` and `MonitorFreq` values if `Mode` value is not configured properly.

- If VCS is running, this command might require to dump the configuration and to restart the agents. The command prompts whether you want to continue. If you choose **Yes**, it restarts the agents that are running and dumps the configuration. It also sets the `Mode` value (for all specified agents) and `MonitorFreq` value (for custom agents only) appropriately to enable IMF. For the agents that are not running, it changes the `Mode` value (for all specified agents) and `MonitorFreq` value (for all specified custom agents only) so as to enable IMF for the agents when they start.

Note: The command prompts you whether you want to make the configuration changes persistent. If you choose **No**, the command exits. If you choose **Yes**, it enables IMF and dumps the configuration by using the `haconf -dump -makero` command.

- If VCS is not running, changes to the `Mode` value (for all specified agents) and `MonitorFreq` value (for all specified custom agents only) need to be made by modifying the VCS configuration files. Before the command makes any changes to configuration files, it prompts you for a confirmation. If you choose **Yes**, it modifies the VCS configuration files. IMF gets enabled for the specified agent when VCS starts.

Example

```
haimfconfig -enable -agent Mount Application
```

The command enables IMF for the Mount agent and the Application agent.

To disable IMF for a set of agents

- ◆ Run the following command:

```
haimfconfig -disable -agent agent(s)
```

This command disables IMF for specified agents by changing the `Mode` value to 0 for each agent and for all resources that had overridden the `Mode` values.

- If VCS is running, the command changes the `Mode` value of the agents and the overridden `Mode` values of all resources of these agents to 0.

Note: The command prompts you whether you want to make the configuration changes persistent. If you choose **No**, the command exits. If you choose **Yes**, it enables IMF and dumps the configuration by using the `haconf -dump -makero` command.

- If VCS is not running, any change to the `Mode` value needs to be made by modifying the VCS configuration file. Before it makes any changes to configuration files, the command prompts you for a confirmation. If you choose **Yes**, it sets the `Mode` value to 0 in the configuration files.

Example

```
haimfconfig -disable -agent Mount Application
```

The command disables IMF for the Mount agent and Application agent.

Enabling and disabling AMF on a system

Enable or disable AMF as follows:

To enable AMF on a system

- ◆ Run the following command:

```
haimfconfig -enable -amf
```

This command sets the value of `AMF_START` to 1 in the AMF configuration file. It also configures and loads the AMF module on the system.

To disable AMF on a system

- ◆ Run the following command:

```
haimfconfig -disable -amf
```

This command unconfigures and unloads the AMF module on the system if AMF is configured and loaded. It also sets the value of `AMF_START` to 0 in the AMF configuration file.

Note: AMF is not directly unconfigured by this command if the agent is registered with AMF. The script prompts you if you want to disable AMF for all agents forcefully before it unconfigures AMF.

Viewing the configuration changes made by the script

View a summary of the steps performed by the command as follows:

To view the changes made when the script enables IMF for an agent

- ◆ Run the following command:

```
haimfconfig -validate -enable -agent agent
```

To view the changes made when the script disables IMF for an agent

- ◆ Run the following command:

```
haimfconfig -validate -disable -agent agent
```

Note: The script also generates the `$VCS_LOG/log/haimfconfig_A.log` file. This log contains information about all the commands that the script runs. It also logs the command outputs and the return values. The last ten logs are backed up.

Displaying the current IMF status of agents

To display current IMF status

- ◆ Run the following command:

```
haimfconfig -display
```

The status of agents can be one of the following:

- ENABLED: IMF is enabled for the agent.
- DISABLED: IMF is disabled for the agent.
- ENABLED|PARTIAL: IMF is partially enabled for some resources of the agent. The possible reasons are:
 - The agent has proper Mode value set at type level and improper mode value set at resource level.
 - The agent has proper Mode value set at resource level and improper mode value set at type level.

Examples:

If IMF is disabled for Mount agent (when Mode is set to 0) and enabled for rest of the installed IMF-aware agents:

```
haimfconfig -display
```

```
#Agent          STATUS
Application     ENABLED
Mount           DISABLED
Process         ENABLED
DiskGroup       ENABLED
WPAR            ENABLED
```

If IMF is disabled for Mount agent (when VCS is running, agent is running and not registered with AMF module) and enabled for rest of the installed IMF-aware agents:

```
haimfconfig -display
```

```
#Agent          STATUS
Application     ENABLED
Mount           DISABLED
Process         ENABLED
DiskGroup       ENABLED
WPAR            ENABLED
```

If IMF is disabled for all installed IMF-aware agents (when AMF module is not loaded):

```
haimfconfig -display
```

```
#Agent          STATUS
Application     DISABLED
Mount           DISABLED
Process         DISABLED
DiskGroup       DISABLED
WPAR            DISABLED
```

If IMF is partially enabled for Mount agent (Mode is set to 3 at type level and to 0 at resource level for some resources) and enabled fully for rest of the installed IMF-aware agents.

```
haimfconfig -display
```

```
#Agent          STATUS
Application     ENABLED
Mount           ENABLED|PARTIAL
Process        ENABLED
DiskGroup       ENABLED
WPAR           ENABLED
```

If IMF is partially enabled for Mount agent (Mode is set to 0 at type level and to 3 at resource level for some resources) and enabled fully for rest of the installed IMF-aware agents:

haimfconfig -display

```
#Agent          STATUS
Application     ENABLED
Mount           ENABLED|PARTIAL
Process        ENABLED
DiskGroup       ENABLED
WPAR           ENABLED
```

Linking and unlinking resources

Link resources to specify a dependency between them. A resource can have an unlimited number of parents and children. When you link resources, the parent cannot be a resource whose Operations attribute is equal to None or OnOnly. Specifically, these are resources that cannot be brought online or taken offline by an agent (None), or can only be brought online by an agent (OnOnly).

Loop cycles are automatically prohibited by the VCS engine. You cannot specify a resource link between resources of different service groups.

To link resources

- ◆ Enter the following command:

```
hares -link parent_resource child_resource
```

The variable *parent_resource* depends on *child_resource* being online before going online itself. Conversely, *parent_resource* goes offline before *child_resource* goes offline.

For example, a NIC resource must be available before an IP resource can go online, so for resources IP1 of type IP and NIC1 of type NIC, specify the dependency as:

```
hares -link IP1 NIC1
```

To unlink resources

- ◆ Enter the following command:

```
hares -unlink parent_resource child_resource
```

Configuring atleast resource dependency

In an atleast resource dependency, the parent resource depends on a set of child resources. The parent resource is brought online or can remain online only if the minimum number of child resources in this resource set is online.

Enter the following command to set atleast resource dependency. This command assumes that there are five child resources. If there are more child resources, enter the resource names without space.

```
hares -link parent_resource  
child_res1,child_res2,child_res3,child_res4,child_res5 -min  
minimum_resources
```

The following is an example:

```
hares -link res1 res2,res3,res4,res5,res6 -min 2
```

In the above example, the parent resource (res1) depends on the child resources (res2, res3, res4, res5, and res6). The parent resource can be brought online only when two or more resources come online and the parent resource can remain online only until two or more child resources are online.

Bringing resources online

This topic describes how to bring a resource online.

To bring a resource online

- ◆ Type the following command:

```
hares -online resource -sys system
```

Taking resources offline

This topic describes how to take a resource offline.

To take a resource offline

- ◆ Type the following command:

```
hares -offline [-ignoreparent|parentprop] resource -sys system
```

The option `-ignoreparent` enables a resource to be taken offline even if its parent resources in the service group are online. This option does not work if taking the resources offline violates the group dependency.

To take a resource and its parent resources offline

- ◆ Type the following command:

```
hares -offline -parentprop resource -sys system
```

The command stops all parent resources in order before taking the specific resource offline.

To take a resource offline and propagate the command to its children

- ◆ Type the following command:

```
hares -offprop [-ignoreparent] resource -sys system
```

As in the above command, the option `-ignoreparent` enables a resource to be taken offline even if its parent resources in the service group are online. This option does not work if taking the resources offline violates the group dependency.

Probing a resource

This topic describes how to probe a resource.

To prompt an agent to monitor a resource on a system

- ◆ Type the following command:

```
hares -probe resource -sys system
```

Though the command may return immediately, the monitoring process may not be completed by the time the command returns.

Clearing a resource

This topic describes how to clear a resource.

To clear a resource

- ◆ Type the following command:

Initiate a state change from RESOURCE_FAULTED to RESOURCE_OFFLINE:

```
hares -clear resource [-sys system]
```

Clearing a resource initiates the online process previously blocked while waiting for the resource to become clear. If *system* is not specified, the fault is cleared on each system in the service group's SystemList attribute.

See [“Clearing faulted resources in a service group”](#) on page 218.

This command also clears the resource's parents. Persistent resources whose static attribute Operations is defined as None cannot be cleared with this command and must be physically attended to, such as replacing a raw disk. The agent then updates the status automatically.

About administering resource types

Administration of resource types includes the following activities:

Adding, deleting, and modifying resource types

After you create a resource type, use the `haattr` command to add its attributes. By default, resource type information is stored in the `types.cf` configuration file.

To add a resource type

- ◆ Type the following command:

```
hatype -add resource_type
```

To delete a resource type

- ◆ Type the following command:

```
hatype -delete resource_type
```

You must delete all resources of the type before deleting the resource type.

To add or modify resource types in main.cf without shutting down VCS

- ◆ Type the following command:

```
hatype -modify resource_type SourceFile "./resource_type.cf"
```

The information regarding *resource_type* is stored in the file *config/resource_type.cf*.

An include line for *resource_type.cf* is added to the *main.cf* file.

Note: Make sure that the path to the SourceFile exists on all nodes before you run this command.

To set the value of static resource type attributes

- ◆ Type the following command for a scalar attribute:

```
hatype -modify resource_type attribute value
```

For more information, type:

```
hatype -help -modify
```

Overriding resource type static attributes

You can override some resource type static attributes and assign them resource-specific values. When a static attribute is overridden and the configuration is saved, the *main.cf* file includes a line in the resource definition for the static attribute and its overridden value.

To override a type's static attribute

- ◆ Type the following command:

```
hares -override resource static_attribute
```

To restore default settings to a type's static attribute

- ◆ Type the following command:

```
hares -undo_override resource static_attribute
```

About initializing resource type scheduling and priority attributes

The following configuration shows how to initialize resource type scheduling and priority attributes through configuration files. The example shows attributes of a FileOnOff resource.

```
type FileOnOff (
    static str AgentClass = RT
    static str AgentPriority = 10
    static str ScriptClass = RT
    static str ScriptPriority = 40
    static str ArgList[] = { PathName }
    str PathName
)
```

Setting scheduling and priority attributes

This topic describes how to set scheduling and priority attributes.

Note: For attributes AgentClass and AgentPriority, changes are effective immediately. For ScriptClass and ScriptPriority, changes become effective for scripts fired after the execution of the `hatype` command.

To update the AgentClass

- ◆ Type the following command:

```
hatype -modify resource_type AgentClass value
```

For example, to set the AgentClass attribute of the FileOnOff resource to RealTime, type:

```
hatype -modify FileOnOff AgentClass "RT"
```

To update the AgentPriority

- ◆ Type the following command:

```
hatype -modify resource_type AgentPriority value
```

For example, to set the AgentPriority attribute of the FileOnOff resource to 10, type:

```
hatype -modify FileOnOff AgentPriority "10"
```

To update the ScriptClass

- ◆ Type the following command:

```
hatype -modify resource_type ScriptClass value
```

For example, to set the ScriptClass of the FileOnOff resource to RealTime, type:

```
hatype -modify FileOnOff ScriptClass "RT"
```

To update the ScriptPriority

- ◆ Type the following command:

```
hatype -modify resource_type ScriptPriority value
```

For example, to set the ScriptClass of the FileOnOff resource to 40, type:

```
hatype -modify FileOnOff ScriptPriority "40"
```

Administering systems

Administration of systems includes tasks such as modifying system attributes, freezing or unfreezing systems, and running commands.

To modify a system's attributes

- ◆ Type the following command:

```
hasys -modify modify_options
```

Some attributes are internal to VCS and cannot be modified.

See [“About the -modify option”](#) on page 175.

To display the value of a system's node ID as defined in the llttab file

- ◆ Type the following command to display the value of a system's node ID as defined in the following file:

```
/etc/llttab
```

```
hasys -nodeid [node_ID]
```

To freeze a system (prevent groups from being brought online or switched on the system)

- ◆ Type the following command:

```
hasys -freeze [-persistent] [-evacuate] system
```

-persistent Enables the freeze to be "remembered" when the cluster is rebooted. Note that the cluster configuration must be in read/write mode and must be saved to disk (dumped) to enable the freeze to be remembered.

-evacuate Fails over the system's active service groups to another system in the cluster before the freeze is enabled.

To unfreeze a frozen system (reenable online and switch of service groups)

- ◆ Type the following command:

```
hasys -unfreeze [-persistent] system
```

To run a command on any system in a cluster

- ◆ Type the following command:

```
hacli -cmd command [-sys | -server system(s)]
```

Issues a command to be executed on the specified system(s). VCS must be running on the systems.

The use of the hacli command requires setting HacliUserLevel to at least COMMANDROOT. By default, the HacliUserLevel setting is NONE.

If the users do not want the root user on system A to enjoy root privileges on another system B, HacliUserLevel should remain set to NONE (the default) on system B.

You can specify multiple systems separated by a single space as arguments to the option -sys. If no system is specified, command runs on all systems in cluster with VCS in a RUNNING state. The command argument must be entered within double quotes if command includes any delimiters or options.

About administering clusters

Administration of clusters includes the following activities:

Configuring and unconfiguring the cluster UUID value

When you install VCS using the installer, the installer generates the cluster UUID (Universally Unique ID) value. This value is the same across all the nodes in the cluster.

You can use the uuidconfig utility to display, copy, configure, and unconfigure the cluster UUID on the cluster nodes.

Make sure you have ssh or rsh communication set up between the systems. The utility uses ssh by default.

To display the cluster UUID value on the VCS nodes

- ◆ Run the following command to display the cluster UUID value:

- For specific nodes:

```
# /opt/VRTSvcs/bin/uuidconfig.pl [-rsh] -clus -display sys1  
[sys2 sys3...]
```

- For all nodes that are specified in the `/etc/llthosts` file:

```
# /opt/VRTSvcs/bin/uuidconfig.pl [-rsh] -clus -display  
-use_llthost
```

To configure cluster UUID on the VCS nodes

- ◆ Run the following command to configure the cluster UUID value:

- For specific nodes:

```
# /opt/VRTSvcs/bin/uuidconfig.pl [-rsh] -clus -configure  
sys1 [sys2 sys3...]
```

- For all nodes that are specified in the `/etc/llthosts` file:

```
# /opt/VRTSvcs/bin/uuidconfig.pl -clus -configure  
-use_llthost
```

The utility configures the cluster UUID on the cluster nodes based on whether a cluster UUID exists on any of the VCS nodes:

- If no cluster UUID exists or if the cluster UUID is different on the cluster nodes, then the utility does the following:
 - Generates a new cluster UUID using the `/opt/VRTSvcs/bin/osuuid`.
 - Creates the `/etc/vx/.uuids/clusuuid` file where the utility stores the cluster UUID.
 - Configures the cluster UUID on all nodes in the cluster.
- If a cluster UUID exists and if the UUID is same on all the nodes, then the utility retains the UUID.
Use the `-force` option to discard the existing cluster UUID and create new cluster UUID.
- If some nodes in the cluster have cluster UUID and if the UUID is the same, then the utility configures the existing UUID on the remaining nodes.

To unconfigure cluster UUID on the VCS nodes

- ◆ Run the following command to unconfigure the cluster UUID value:

- For specific nodes:

```
# /opt/VRTSvcs/bin/uuidconfig.pl [-rsh] -clus  
-unconfigure sys1 [sys2 sys3...]
```

- For all nodes that are specified in the `/etc/llthosts` file:

```
# /opt/VRTSvcs/bin/uuidconfig.pl [-rsh] -clus  
-unconfigure -use_llthost
```

The utility removes the `/etc/vx/.uuids/clusuuid` file from the nodes.

To copy the cluster UUID from one node to other nodes

- ◆ Run the following command to copy the cluster UUID value:

```
# /opt/VRTSvcs/bin/uuidconfig.pl [-rsh] -clus -copy  
-from_sys sys -to_sys sys1 sys2 [sys3...]
```

The utility copies the cluster UUID from a system that is specified using the `-from_sys` option to all the systems that are specified using the `-to_sys` option.

Retrieving version information

This topic describes how to retrieve information about the version of VCS running on the system.

To retrieve information about the VCS version on the system

- 1 Run one of the following commands to retrieve information about the engine version, the join version, the build date, and the PSTAMP.

```
had -version  
hastart -version
```

- 2 Run one of the following commands to retrieve information about the engine version.

```
had -v  
hastart -v
```

Adding and removing systems

This topic provides an overview of tasks involved in adding and removing systems from a cluster.

For detailed instructions, see the *Cluster Server Installation Guide*.

To add a system to a cluster

- 1 Make sure that the system meets the hardware and software requirements for VCS.
- 2 Set up the private communication links from the new system.
- 3 Install VCS and required patches on the new system.
- 4 Add the VCS license key.
See [“About installing a VCS license”](#) on page 179.
- 5 Configure LLT and GAB to include the new system in the cluster membership.
- 6 Add the new system using the `hasys -add` command.

To remove a node from a cluster

- 1 Make a backup copy of the current configuration file, `main.cf`.
- 2 Switch or remove any VCS service groups from the node. The node cannot be removed as long as it runs service groups on which other service groups depend.
- 3 Stop VCS on the node.

```
hastop -sys systemname
```
- 4 Delete the system from the SystemList of all service groups.

```
hagrp -modify groupname SystemList -delete systemname
```
- 5 Delete the node from the cluster.

```
hasys -delete systemname
```
- 6 Remove the entries for the node from the `/etc/llthosts` file on each remaining node.
- 7 Change the node count entry from the `/etc/gabtab` file on each remaining node.
- 8 Unconfigure GAB and LLT on the node leaving the cluster.
- 9 Remove VCS and other filesets from the node.
- 10 Remove GAB and LLT configuration files from the node.

Changing ports for VCS

You can change some of the default ports for VCS and its components.

The following is a list of changes that you can make and information concerning ports in a VCS environment:

- Changing VCS's default port.
Add an entry for a VCS service name in `/etc/services` file, for example:

```
vcs-app 3333/tcp # Veritas Cluster Server
```

Where 3333 in the example is the port number where you want to run VCS. When the engine starts, it listens on the port that you configured above (3333) for the service. You need to modify the port to the `/etc/services` file on all the nodes of the cluster.

- You do not need to make changes for agents or HA commands. Agents and HA commands use locally present UDS sockets to connect to the engine, not TCP/IP connections.
- You do not need to make changes for HA commands that you execute to talk to a remotely running VCS engine (HAD), using the facilities that the `VCS_HOST` environment variable provides. You do not need to change these settings because the HA command queries the `/etc/services` file and connects to the appropriate port.
- For the Java Console GUI, you can specify the port number that you want the GUI to connect to while logging into the GUI. You have to specify the port number that is configured in the `/etc/services` file (for example 3333 above).

To change the default port

- 1 Stop VCS.
- 2 Add an entry service name `vcs-app` in `/etc/services`.

```
vcs-app 3333/tcp # Veritas Cluster Server
```

- 3 You need to modify the port to the `/etc/services` file on all the nodes of the cluster.
- 4 Restart VCS.
- 5 Check the port.

```
# netstat -an|grep 3333  
  
*.3333 *.* 0 0 49152 0 LISTEN  
*.3333 *.* 0 0 49152 0 LISTEN
```

- 6 Use the Java Console to connect to VCS through port 3333.

Setting cluster attributes from the command line

This topic describes how to set cluster attributes from the command line.

Note: For the attributes `EngineClass` and `EnginePriority`, changes are effective immediately. For `ProcessClass` and `ProcessPriority` changes become effective only for processes fired after the execution of the `haclus` command.

To modify a cluster attribute

- ◆ Type the following command

```
# haclus [-help [-modify]]
```

To update the `EngineClass`

- ◆ Type the following command:

```
# haclus -modify EngineClass value
```

For example, to set the `EngineClass` attribute to `RealTime`:

```
# haclus -modify EngineClass "RT"
```

To update the `EnginePriority`

- ◆ Type the following command:

```
# haclus -modify EnginePriority value
```

For example, to set the `EnginePriority` to `20`:

```
# haclus -modify EnginePriority "20"
```

To update the `ProcessClass`

- ◆ Type the following command:

```
# haclus -modify ProcessClass value
```

For example, to set the `ProcessClass` to `TimeSharing`:

```
# haclus -modify ProcessClass "TS"
```

To update the ProcessPriority

- ◆ Type the following command:

```
# haclus -modify ProcessPriority value
```

For example, to set the ProcessPriority to 40:

```
# haclus -modify ProcessPriority "40"
```

About initializing cluster attributes in the configuration file

You may assign values for cluster attributes while you configure the cluster.

See [“Cluster attributes”](#) on page 831.

Review the following sample configuration:

```
cluster vcs-india (  
    EngineClass = "RT"  
    EnginePriority = "20"  
    ProcessClass = "TS"  
    ProcessPriority = "40"  
)
```

Enabling and disabling secure mode for the cluster

This topic describes how to enable and disable secure mode for your cluster.

To enable secure mode in a VCS cluster

1 # `hasys -state`

The output must show the SysState value as RUNNING.

2 You can enable secure mode or secure mode with FIPS.

To enable secure mode, start the installer program with the `-security` option.

```
# /opt/VRTS/install/installer -security
```

To enable secure mode with FIPS, start the installer program with the `-security -fips` option.

```
# /opt/VRTS/install/installvcs -security -fips
```

If you already have secure mode enabled and need to move to secure mode with FIPS, complete the steps in the following procedure.

See [“Migrating from secure mode to secure mode with FIPS”](#) on page 250.

The installer displays the directory where the logs are created.

3 Review the output as the installer verifies whether VCS configuration files exist.

The installer also verifies that VCS is running on all systems in the cluster.

4 The installer checks whether the cluster is in secure mode or non-secure mode. If the cluster is in non-secure mode, the installer prompts whether you want to enable secure mode.

```
Do you want to enable secure mode in this cluster? [y,n,q] (y) y
```

5 Review the output as the installer modifies the VCS configuration files to enable secure mode in the cluster, and restarts VCS.

To disable secure mode in a VCS cluster

1 Start the installer program with the `-security` option.

```
# /opt/VRTS/install/installer -security
```

To disable secure mode with FIPS, use the following command:

```
# /opt/VRTS/install/installvcs -security -fips
```

The installer displays the directory where the logs are created.

2 Review the output as the installer proceeds with a verification.

- 3 The installer checks whether the cluster is in secure mode or non-secure mode. If the cluster is in secure mode, the installer prompts whether you want to disable secure mode.

```
Do you want to disable secure mode in this cluster? [y,n,q] (y) y
```

- 4 Review the output as the installer modifies the VCS configuration files to disable secure mode in the cluster, and restarts VCS.

Migrating from secure mode to secure mode with FIPS

To migrate from secure mode to secure mode with FIPS

- 1 Unconfigure security.

```
# installvcs -security
```

- 2 Clear the credentials that exist in the following directories:

- `/var/VRTSvcs/vcsauth`
- `/var/VRTSat`
- `/var/VRTSat_lhc`
- `.VRTSat` from the home directories of all the VCS users

- 3 Configure security in FIPS mode.

```
# installvcs -security -fips
```

Using the `-wait` option in scripts that use VCS commands

The `-wait` option is for use in the scripts that use VCS commands to wait till an attribute value changes to the specified value. The option blocks the VCS command until the value of the specified attribute is changed or until the specified timeout expires. Specify the timeout in seconds.

The option can be used only with changes to scalar attributes.

The `-wait` option is supported with the following commands:

haclus	<pre>haclus -wait attribute value [-clus cluster] [-time timeout]</pre>	Use the <code>-clus</code> option in a global cluster environment.
hagrp	<pre>hagrp -wait group attribute value [-clus cluster] [-sys system] [-time timeout]</pre>	Use the <code>-sys</code> option when the scope of the attribute is local. Use the <code>-clus</code> option in a global cluster environment.
hares	<pre>hares -wait resource attribute value [-clus cluster] [-sys system] [-time timeout]</pre>	Use the <code>-sys</code> option when the scope of the attribute is local. Use the <code>-clus</code> option in a global cluster environment.
hasys	<pre>hasys -wait system attribute value [-clus cluster] [-time timeout]</pre>	Use the <code>-clus</code> option in a global cluster environment.

See the man pages associated with these commands for more information.

Running HA fire drills

The service group must be online when you run the HA fire drill.

See [“About testing resource failover by using HA fire drills”](#) on page 298.

To run HA fire drill for a specific resource

- ◆ Type the following command.

```
# hares -action <resname> <vfdaction>.vfd -sys <sysname>
```

The command runs the infrastructure check and verifies whether the system `<sysname>` has the required infrastructure to host the resource `<resname>`, should a failover require the resource to come online on the system. For the variable `<sysname>`, specify the name of a system on which the resource is offline. The variable `<vfdaction>` specifies the Action defined for the agent. The "HA fire drill checks" for a resource type are defined in the SupportedActions attribute for that resource and can be identified with the `.vfd` suffix.

To run HA fire drill for a service group

- ◆ Type the following command.

```
# havfd <grpname> -sys <sysname>
```

The command runs the infrastructure check and verifies whether the system *<sysname>* has the required infrastructure to host resources in the service group *<grpname>* should a failover require the service group to come online on the system. For the variable *<sysname>*, specify the name of a system on which the group is offline

To fix detected errors

- ◆ Type the following command.

```
# hares -action <resname> <vfdaction>.vfd -actionargs fix -sys  
<sysname>
```

The variable *<vfdaction>* represents the check that reported errors for the system *<sysname>*. The "HA fire drill checks" for a resource type are defined in the SupportedActions attribute for that resource and can be identified with the .vfd suffix.

About administering simulated clusters from the command line

VCS Simulator is a tool to assist you in building and simulating cluster configurations. With VCS Simulator you can predict service group behavior during cluster or system faults, view state transitions, and designate and fine-tune various configuration parameters. This tool is especially useful when you evaluate complex, multi-node configurations. It is convenient in that you can design a specific configuration without test clusters or changes to existing configurations.

You can also fine-tune values for attributes that govern the rules of failover, such as Load and Capacity in a simulated environment. VCS Simulator enables you to simulate various configurations and provides the information that you need to make the right choices. It also enables simulating global clusters.

See ["About VCS Simulator"](#) on page 300.

Configuring applications and resources in VCS

This chapter includes the following topics:

- [Configuring resources and applications](#)
- [VCS bundled agents for UNIX](#)
- [Configuring NFS service groups](#)
- [About configuring the RemoteGroup agent](#)
- [About configuring Samba service groups](#)
- [Configuring the Coordination Point agent](#)
- [About migration of data from LVM volumes to VxVM volumes](#)
- [About testing resource failover by using HA fire drills](#)

Configuring resources and applications

Configuring resources and applications in VCS involves the following tasks:

- Create a service group that comprises all resources that are required for the application.
To configure resources, you can use any of the supported components that are used for administering VCS.
See “[Components for administering VCS](#)” on page 48.
- Add required resources to the service group and configure them.
For example, to configure a database in VCS, you must configure resources for the database and for the underlying shared storage and network resources.

Use appropriate agents to configure resources.

See [“VCS bundled agents for UNIX”](#) on page 254.

Configuring a resource involves defining values for its attributes.

See the *Cluster Server Bundled Agents Reference Guide* for a description of the agents provided by VCS.

The resources must be logically grouped in a service group. When a resource faults, the entire service group fails over to another node.

- Assign dependencies between resources. For example, an IP resource depends on a NIC resource.
- Bring the service group online to make the resources available.

VCS bundled agents for UNIX

Bundled agents are categorized according to the type of resources they make highly available.

See [“About Storage agents”](#) on page 254.

See [“About Network agents”](#) on page 255.

See [“About File share agents”](#) on page 257.

See [“About Services and Application agents”](#) on page 258.

See [“About VCS infrastructure and support agents”](#) on page 259.

See [“About Testing agents”](#) on page 260.

About Storage agents

Storage agents monitor shared storage and make shared storage highly available. Storage includes shared disks, disk groups, volumes, and mounts. The DiskGroup agent supports both IMF-based monitoring and traditional poll-based monitoring.

See the *Cluster Server Bundled Agents Reference Guide* for a detailed description of the following agents.

[Table 7-1](#) shows Storage agents and their description.

Table 7-1 Storage agents and their description

Agent	Description
DiskGroup	<p>Brings Veritas Volume Manager (VxVM) disk groups online and offline, monitors them, and make them highly available. The DiskGroup agent supports both IMF-based monitoring and traditional poll-based monitoring.</p> <p>No dependencies exist for the DiskGroup resource.</p>
DiskGroupSnap	<p>Brings resources online and offline and monitors disk groups used for fire drill testing. The DiskGroupSnap agent enables you to verify the configuration integrity and data integrity in a Campus Cluster environment with VxVM stretch mirroring. The service group that contains the DiskGroupSnap agent resource has an offline local dependency on the application's service group. This is to ensure that the fire drill service group and the application service group are not online at the same site.</p>
Volume	<p>Makes Veritas Volume Manager(VxVM) Volumes highly available and enables you to bring the volumes online and offline, and monitor them. Volume resources depend on DiskGroup resources.</p>
VolumeSet	<p>Brings Veritas Volume Manager (VxVM) volume sets online and offline, and monitors them. Use the VolumeSet agent to make a volume set highly available. VolumeSet resources depend on DiskGroup resources.</p>
LVMVG	<p>Activates, deactivates, and monitors a Logical Volume Manager (LVM) volume group. The LVMVG agent supports JFS or JFS2. It does not support VxFS. This agent ensures that the Object Data Manager (ODM) is synchronized with changes to the volume group. No dependencies exist for the LVMVG resource.</p>
Mount	<p>Brings resources online and offline, monitors file system or NFS client mount points, and make them highly available. The Mount agent supports both IMF-based monitoring and traditional poll-based monitoring.</p> <p>The Mount agent can be used with the DiskGroup, LVMVG, and Volume agents to provide storage to an application.</p> <p>See "About resource monitoring" on page 40.</p>

About Network agents

Network agents monitor network resources and make your IP addresses and computer names highly available. Network agents support both IPv4 and IPv6 addresses. However, you cannot use the two types of addresses concurrently.

See the *Cluster Server Bundled Agents Reference Guide* for a detailed description of the following agents.

[Table 7-2](#) shows the Network agents and their description.

Table 7-2 Network agents and their description

Agent	Description
NIC	Monitors a configured NIC. If a network link fails or if a problem arises with the NIC, the resource is marked FAULTED. You can use the NIC agent to make a single IP address on a single adapter highly available and monitor it. No child dependencies exist for this resource.
IP	Manages the process of configuring a virtual IP address and its subnet mask on an interface. You can use the IP agent to monitor a single IP address on a single adapter. The interface must be enabled with a physical (or administrative) base IP address before you can assign it a virtual IP address.
MultiNICA	Represents a set of network interfaces and provides failover capabilities between them. You can use the MultiNICA agent to make IP addresses on multiple adapter systems highly available and to monitor them. If a MultiNICA resource changes its active device, the MultiNICA agent handles the shifting of IP addresses.
IPMultiNIC	Manages a virtual IP address that is configured as an alias on one interface of a MultiNICA resource. If the interface faults, the IPMultiNIC agent works with the MultiNICA resource to fail over to a backup NIC. The IPMultiNIC agent depends upon the MultiNICA agent to select the most preferred NIC on the system.
MultiNICB	Works with the IPMultiNICB agent. The MultiNICB agent allows IP addresses to fail over to multiple NICs on the same system before VCS tries to fail over to another system. You can use the agent to make IP addresses on multiple-adapter systems highly available or to monitor them. No dependencies exist for the MultiNICB resource.
IPMultiNICB	Works with the MultiNICB agent. The IPMultiNICB agent configures and manages virtual IP addresses (IP aliases) on an active network device that the MultiNICB resource specifies. When the MultiNICB agent reports a particular interface as failed, the IPMultiNICB agent moves the IP address to the next active interface. IPMultiNICB resources depend on MultiNICB resources.

Table 7-2 Network agents and their description (*continued*)

Agent	Description
DNS	Updates and monitors the mapping of host names to IP addresses and canonical names (CNAME). The DNS agent performs these tasks for a DNS zone when it fails over nodes across subnets (a wide-area failover). Use the DNS agent when the failover source and target nodes are on different subnets. The DNS agent updates the name server and allows clients to connect to the failed over instance of the application service.

About File share agents

File Service agents make shared directories and subdirectories highly available.

See the *Cluster Server Bundled Agents Reference Guide* for a detailed description of these agents.

[Table 7-3](#) shows the File share agents and their description.

Table 7-3 File share agents and their description

Agent	Description
NFS	Manages NFS daemons which process requests from NFS clients. The NFS Agent manages the <code>rpc.nfsd/nfsd</code> daemon and the <code>rpc.mountd</code> daemon on the NFS server. If NFSv4 support is enabled, it also manages the <code>rpc.idmapd/nfsmapid</code> daemon.
NFSRestart	Provides NFS lock recovery in case of application failover or server crash. The NFSRestart Agent also prevents potential NFS ACK storms by closing all TCP connections of NFS servers with the client before the service group failover occurs. It also manages essential NFS lock and status daemons, <code>lockd</code> and <code>statd</code> .
Share	Shares, unshares, and monitors a single local resource for exporting an NFS file system that is mounted by remote systems. Share resources depend on NFS. In an NFS service group, the IP family of resources depends on Share resources.
SambaServer	Starts, stops, and monitors the <code>smbd</code> process as a daemon. You can use the SambaServer agent to make an <code>smbd</code> daemon highly available or to monitor it. The <code>smbd</code> daemon provides Samba share services. The SambaServer agent, with SambaShare and NetBIOS agents, allows a system running a UNIX or UNIX-like operating system to provide services using the Microsoft network protocol. It has no dependent resource.

Table 7-3 File share agents and their description (*continued*)

Agent	Description
SambaShare	Adds, removes, and monitors a share by modifying the specified Samba configuration file. You can use the SambaShare agent to make a Samba Share highly available or to monitor it. SambaShare resources depend on SambaServer, NetBios, and Mount resources.
NetBIOS	Starts, stops, and monitors the nmbd daemon. You can use the NetBIOS agent to make the nmbd daemon highly available or to monitor it. The nmbd process broadcasts the NetBIOS name, or the name by which the Samba server is known in the network. The NetBios resource depends on the IP or the IPMultiNIC resource.

About Services and Application agents

Services and Application agents make Web sites, applications, and processes highly available.

See the *Cluster Server Bundled Agents Reference Guide* for a detailed description of these agents.

[Table 7-4](#) shows the Services and Applications agents and their description.

Table 7-4 Services and Application agents and their description

Agent	Description
Apache	Brings an Apache Server online, takes it offline, and monitors its processes. Use the Apache Web server agent with other agents to make an Apache Web server highly available. This type of resource depends on IP and Mount resources. The Apache agent can detect when an Apache Web server is brought down gracefully by an administrator. When Apache is brought down gracefully, the agent does not trigger a resource fault even though Apache is down. The Apache agent supports both IMF-based monitoring for online monitoring and traditional poll-based monitoring.

Table 7-4 Services and Application agents and their description (*continued*)

Agent	Description
Application	<p>Brings applications online, takes them offline, and monitors their status. Use the Application agent to specify different executables for the online, offline, and monitor routines for different programs. The executables must exist locally on each node. You can use the Application agent to provide high availability for applications that do not have bundled agents, enterprise agents, or custom agents. This type of resource can depend on IP, IPMultiNIC, and Mount resources. The Application agent supports both IMF-based monitoring and traditional poll-based monitoring.</p> <p>See "About resource monitoring" on page 40.</p>
Process	<p>Starts, stops, and monitors a process that you specify. Use the Process agent to make a process highly available. This type of resource can depend on IP, IPMultiNIC, and Mount resources. The Process agent supports both IMF-based monitoring and traditional poll-based monitoring.</p> <p>See "About resource monitoring" on page 40.</p>
ProcessOnOnly	<p>Starts and monitors a process that you specify. Use the agent to make a process highly available. No child dependencies exist for this resource.</p>
WPAR	<p>Brings workload partitions online, takes them offline, and monitors their status. The WPAR agent supports both IMF-based monitoring and traditional poll-based monitoring.</p>
MemCPUAllocator	<p>Allocates CPU and memory for IBM AIX dedicated partitions.</p>
LPAR	<p>Brings logical partitions (LPARs) online, takes them offline, and monitors their status. The LPAR agent controls the LPAR by contacting the Hardware Management Console (HMC). Communication between HMC and the LPAR running the LPAR agent is through passwordless ssh.</p>

About VCS infrastructure and support agents

VCS infrastructure and support agents monitor Veritas components and VCS objects.

See the *Cluster Server Bundled Agents Reference Guide* for a detailed description of these agents.

[Table 7-5](#) shows the VCS infrastructure and support agents and their description.

Table 7-5 VCS infrastructure and support agents and their description

Agent	Description
NotifierMngr	Starts, stops, and monitors a notifier process, making it highly available. The notifier process manages the reception of messages from VCS and the delivery of those messages to SNMP consoles and SMTP servers. The NotifierMngr resource can depend on the NIC resource.
Proxy	Mirrors the state of another resource on a local or remote system. It provides a method to specify and modify one resource and have its state reflected by its proxies. You can use the Proxy agent to replicate the status of a resource. For example, a service group that uses the NFS resource can use a Proxy resource. The Proxy resource can point to the NFS resource in a separate parallel service group.
Phantom	Enables VCS to determine the state of parallel service groups that do not include OnOff resources. No dependencies exist for the Phantom resource.
RemoteGroup	Establishes dependencies between applications that are configured on different VCS clusters. For example, if you configure an Apache resource in a local cluster and a MySQL resource in a remote cluster, the Apache resource depends on the MySQL resource. You can use the RemoteGroup agent to establish the dependency between two resources and to monitor or manage a service group that exists in a remote cluster.
CoordPoint	Monitors the I/O fencing coordination points.

About Testing agents

Testing agents provide high availability for program support resources that are useful for testing VCS functionality.

See the *Cluster Server Bundled Agents Reference Guide* for a detailed description of these agents.

[Table 7-6](#) shows VCS Testing agents and their description.

Table 7-6 Testing agents and their description

Agent	Description
ElifNone	Monitors a file and checks for the file's absence. You can use the ElifNone agent to test service group behavior. No dependencies exist for the ElifNone resource.

Table 7-6 Testing agents and their description (*continued*)

Agent	Description
FileNone	Monitors a file and checks for the file's existence. You can use the FileNone agent to test service group behavior. No dependencies exist for the FileNone resource.
FileOnOff	Creates, removes, and monitors files. You can use the FileOnOff agent to test service group behavior. No dependencies exist for the FileOnOff resource.
FileOnOnly	Creates and monitors files but does not remove files. You can use the FileOnOnly agent to test service group behavior. No dependencies exist for the FileOnOnly resource.

Configuring NFS service groups

This section describes the features of NFS and the methods of configuring NFS.

About NFS

Network File System (NFS) allows network users to access shared files stored on an NFS server. NFS lets users manipulate shared files transparently as if the files were on a local disk.

NFS terminology

Key terms used in NFS operations include:

NFS Server	The computer that makes the local file system accessible to users on the network.
NFS Client	The computer which accesses the file system that is made available by the NFS server.
rpc.mountd	A daemon that runs on NFS servers. It handles initial requests from NFS clients. NFS clients use the mount command to make requests.
rpc.nfsd/nfsd	A daemon that runs on NFS servers. It is formed of stateless kernel threads that handle most of the NFS requests (including NFS read/write requests) from NFS clients.

rpc.lockd/lockd	<p>A daemon that runs on NFS servers and NFS clients.</p> <p>On the server side, it receives lock requests from the NFS client and passes the requests to the kernel-based nfsd.</p> <p>On the client side, it forwards the NFS lock requests from users to the rpc.lockd/lockd on the NFS server.</p>
rpc.statd/statd	<p>A daemon that runs on NFS servers and NFS clients.</p> <p>On the server side, it maintains the information about NFS clients that have locks and NFS clients that are trying for locks. If the NFS server recovers after a crash, rpc.statd/statd notifies all the NFS clients to reclaim locks that they had before the server crash. This process is called NFS lock recovery.</p> <p>On the client side, it maintains a list of servers for which users requested locks. It also processes notification from the server statd/rpc.statd. If the NFS client recovers after a crash, rpc.statd/statd notifies the NFS server to stop monitoring the client since the client restarted.</p>
rpc.idmapd/nfsmapid	<p>A userland daemon that maps the NFSv4 username and group to the local username and group of the system. This daemon is specific to NFSv4.</p>
rpc.svcgssd	<p>A userland daemon runs on NFS server. It provides rpcsec_gss security to the RPC daemons.</p>
NFSv4	<p>The latest version of NFS. It is a stateful protocol. NFSv4 requires only the rpc.nfsd/nfsd daemon to be running on the system. It does not require the associate daemons rpc.mountd, statd, and lockd.</p>

About managing and configuring NFS

VCS uses agents to monitor and manage the entities related to NFS. These agents include NFS Agent, Share Agent, NFSRestart Agent, IP Agent, IPMultiNIC Agent, and IPMultiNICA Agent.

For information about these agents and their roles in providing NFS high availability, see the *Cluster Server Bundled Agents Reference Guide*.

See [“About File share agents”](#) on page 257.

Configuring NFS service groups

You can configure NFS with VCS in several ways. The following configurations are supported for NFS service groups supported by VCS.

- Configuring for a single NFS environment

Use this configuration to export all the local directories from a single virtual IP address. In this configuration, the NFS resource is part of a failover service group and there is only one NFS related service group in the entire clustered environment. This configuration supports lock recovery and also handles potential NFS ACK storms. This configuration also supports NFSv4. See [“Configuring for a single NFS environment”](#) on page 263.

- **Configuring for a multiple NFS environment**
Use this configuration to export the NFS shares from a multiple virtual IP addresses. You need to create different NFS share service groups, where each service group has one virtual IP address. Note that NFS is now a part of a different parallel service group. This configuration supports lock recovery and also prevents potential NFS ACK storms. This configuration also supports NFSv4. See [“Configuring for a multiple NFS environment”](#) on page 265.
- **Configuring for multiple NFS environment with separate storage**
Use this configuration to put all the storage resources into a separate service group. The storage resources such as Mount and DiskGroup are part of different service group. In this configuration, the NFS share service group depends on the storage service group. SFCFSHA uses this configuration where the service group containing the storage resources is a parallel service group. See [“Configuring NFS with separate storage”](#) on page 267.
- **Configuring NFS services in a parallel service group**
Use this configuration when you want only the NFS service to run. If you want any of the functionality provided by the NFSRestart agent, do not use this configuration. This configuration has some disadvantages because it does not support NFS lock recovery and it does not prevent potential NFS ACK storms. Veritas does not recommend this configuration. See [“Configuring all NFS services in a parallel service group”](#) on page 268.

Configuring for a single NFS environment

Use this configuration to export all the local directories from a single virtual IP address. In this configuration, the NFS resource is part of a failover service group and there is only one NFS related service group in the entire clustered environment. This configuration supports lock recovery and also handles potential NFS ACK storms. This configuration also supports NFSv4.

Creating the NFS exports service group

This service group contains the Share and IP resources for exports. The PathName attribute's value for the Share resource must be on shared storage and it must be visible to all nodes in the cluster.

To create the NFS exports service group

- 1 Create an NFS resource inside the service group.

Note: You must set NFSLockFailover to 1 for NFSRestart resource if you intend to use NFSv4.

- 2 If you configure the backing store for the NFS exports using VxVM, create DiskGroup and Mount resources for the mount point that you want to export. If you configure the backing store for the NFS exports using LVM, configure the LVMVG resource and Mount resource for the mount point that you want to export.

Refer to Storage agents chapter in the *Cluster Server Bundled Agents Reference Guide* for details.

- 3 Create an NFSRestart resource. Set the Lower attribute of this NFSRestart resource to 1. Ensure that NFSRes attribute points to the NFS resource that is on the system.

For NFS lock recovery, make sure that the NFSLockFailover attribute and the LocksPathName attribute have appropriate values. The NFSRestart resource depends on the Mount and NFS resources that you have configured for this service group.

Note: The NFSRestart resource gets rid of preonline and postoffline triggers for NFS.

- 4 Create a Share resource. Set the PathName to the mount point that you want to export. In case of multiple shares, create multiple Share resources with different values for their PathName attributes. All the Share resources configured in the service group should have dependency on the NFSRestart resource with a value of 1 for the Lower attribute.
- 5 Create an IP resource. The value of the Address attribute for this IP resource is used to mount the NFS exports on the client systems. Make the IP resource depend on the Share resources that are configured in the service group.

- 6 Create a DNS resource if you want NFS lock recovery. The DNS resource depends on the IP resource. Refer to the sample configuration on how to configure the DNS resource.
- 7 Create an NFSRestart resource. Set the NFSRes attribute to the NFS resource (nfs) that is configured on the system. Set the Lower attribute of this NFSRestart resource to 0. Make the NFSRestart resource depend on the IP resource or the DNS resource (if you want to use NFS lock recovery.)

Note: Ensure that all attributes except the Lower attribute are identical for the two NFSRestart resources.

Configuring for a multiple NFS environment

Use this configuration to export the NFS shares from multiple virtual IP addresses. You need to create different NFS share service groups, where each service group has one virtual IP address. The following example has a single service group with a virtual IP. Note that NFS is now a part of a different parallel service group. This configuration supports lock recovery and also prevents potential NFS ACK storms. This configuration also supports NFSv4.

Creating the NFS service group for a multiple NFS environment

This service group contains an NFS resource. Depending on the service group's use, it can also contain a NIC resource and a Phantom resource.

To create the NFS service group

- 1 Configure a separate parallel service group (nfs_grp).
- 2 Set the value of the AutoStart and Parallel attributes to 1 for the service group.
- 3 The value for the AutoStartList attribute must contain the list of all the cluster nodes in the service group.
- 4 Configure an NFS resource (nfs) inside this service group. You can also put NIC resource in this service group to monitor a NIC.

Note: You must set NFSLockFailover to 1 for NFSRestart resource if you intend to use NFSv4.

- 5 You must create a Phantom resource in this service group to display the correct state of the service group.

Creating the NFS exports service group for a multiple NFS environment

This service group contains the Share and IP resources for exports. The value for the PathName attribute for the Share resource must be on shared storage and it must be visible to all nodes in the cluster.

To create the NFS exports service group

- 1 Create an NFS Proxy resource inside the service group. This Proxy resource points to the actual NFS resource that is configured on the system.
- 2 If you configure the backing store for the NFS exports with VxVM, create DiskGroup and Mount resources for the mount point that you want to export.

If the backing store for the NFS exports is configured using LVM, configure the LVMVG resource and Mount resources for the mount points that you want to export.

Refer to Storage agents in the *Cluster ServerBundled Agents Reference Guide* for details.
- 3 Create an NFSRestart resource. Set the Lower attribute of this NFSRestart resource to 1. Ensure that NFSRes attribute points to the NFS resource configured on the system.

For NFS lock recovery, make sure that the NFSLockFailover attribute and the LocksPathName attribute have appropriate values. The NFSRestart resource depends on the Mount resources that you have configured for this service group. The NFSRestart resource gets rid of preonline and postoffline triggers for NFS.
- 4 Create a Share resource. Set the PathName attribute to the mount point that you want to export. In case of multiple shares, create multiple Share resources with different values for their PathName attributes. All the Share resources that are configured in the service group need to have dependency on the NFSRestart resource that has a value of 1 for its Lower attribute.
- 5 Create an IP resource. The value of the Address attribute for this IP resource is used to mount the NFS exports on the client systems. Make the IP resource depend on the Share resources that are configured in the service group.
- 6 Create a DNS resource if you want NFS lock recovery. The DNS resource depends on the IP resource. Refer to the sample configuration on how to configure the DNS resource.
- 7 Create an NFSRestart resource. Set the NFSRes attribute to the NFS resource (nfs) that is configured on the system. Set the value of the Lower attribute for this NFSRestart resource to 0. Make the NFSRestart resource depend on the IP resource or the DNS resource to use NFS lock recovery.

Note: Ensure that all attributes except the Lower attribute are identical for the two NFSRestart resources.

Configuring NFS with separate storage

Use this configuration to put all the storage resources into a separate service group. The storage resources such as Mount and DiskGroup are part of different service group. In this configuration, the NFS share service group depends on the storage service group. SFCFSHA uses this configuration where the service group containing the storage resources is a parallel service group.

Creating the NFS service group

This service group contains an NFS resource. Depending on the service group's use, it can also contain a NIC resource and a Phantom resource.

To create the NFS service group

- 1 Configure a separate parallel service group (nfs_grp).
- 2 Set the value of the AutoStart and Parallel attributes to 1 for the service group.
- 3 The value for the AutoStartList must contain the list of all the cluster nodes in the service group.
- 4 Configure an NFS resource (nfs) inside this service group. You can also put NIC resource in this service group to monitor a NIC. You must create a Phantom resource in this service group to display the correct state of the service group.

Note: You must set NFSLockFailover to 1 for NFSRestart resource if you intend to use NFSv4.

Creating the NFS storage service group

This service group can contain a DiskGroup resource and a Mount resource.

To create the NFS storage service group

- ◆ If you configure the backing store for the NFS exports with VxVM, create DiskGroup and Mount resources for the mount point that you want to export.

Refer to Storage agents chapter in the *Cluster Server Bundled Agents Reference Guide* for details.

Creating the NFS exports service group

This service group contains the Share resource and IP resource for exports. The value for the PathName attribute for the Share resource must be on shared storage and it must be visible to all nodes in the cluster.

To create the NFS exports service group

- 1 Create an online local hard dependency between this service group and the storage service group.
- 2 Create an NFS Proxy resource inside the service group. This Proxy resource points to the actual NFS resource that is configured on the system.
- 3 Create an NFSRestart resource. Set the Lower attribute of this NFSRestart resource to 1. Ensure that NFSRes attribute points to the NFS resource that is configured on the system. For NFS lock recovery, make sure that the NFSLockFailover attribute and the LocksPathName attribute have appropriate values. The NFSRestart resource gets rid of preonline and postoffline triggers for NFS.
- 4 Create a Share resource. Set the value of the PathName attribute to the mount point that you want to export. In case of multiple shares, create multiple Share resources with different values for their PathName attributes. All the Share resources configured in the service group need to have dependency on the NFSRestart resource that has a value of 1 for the Lower attribute.
- 5 Create an IP resource. The value of the Address attribute for this IP resource is used to mount the NFS exports on the client systems. Make the IP resource depend on the Share resources that are configured in the service group.
- 6 Create a DNS resource if you want to use NFS lock recovery. The DNS resource depends on the IP resource. Refer to the sample configuration on how to configure the DNS resource.
- 7 Create an NFSRestart resource. Set the NFSRes attribute to the NFS resource (nfs) that is configured on the system. Set the Lower attribute of this NFSRestart resource to 0. To use lock recovery, make the NFSRestart resource depend on the IP resource or the DNS resource.

Note: Ensure that all attributes except the Lower attribute are identical for the two NFSRestart resources.

Configuring all NFS services in a parallel service group

Use this configuration when you want only the NFS service to run. If you want any of the functionality provided by the NFSRestart agent, do not use this configuration. This configuration has some disadvantages because it does not support NFS lock recovery and it does not prevent potential NFS ACK storms. Veritas does not recommend this configuration.

Creating the NFS service group

This service group contains an NFS resource and an NFSRestart resource.

To create the NFS service group

- 1 Configure a separate parallel service group (nfs_grp).
- 2 Set the value of the AutoStart and Parallel attributes to 1 for the service group. The value for the AutoStartList must contain the list of all the cluster nodes in the service group.
- 3 Configure an NFS resource (nfs) inside this service group. You can also put NIC resource in this service group to monitor a NIC.
- 4 Configure an NFSRestart resource inside this service group. Set the value of Lower attribute to 2. The NFSRes attribute of this resource must point to the NFS resource (nfs) configured on the system. NFSLockFailover is not supported in this configuration.

Note:

- NFSLockFailover is not supported in this configuration.
- This configuration does not prevent potential NFS ACK storms.
- NFSv4 is not supported in this configuration.

Creating the NFS exports service group

This service group contains the Share and IP resources for exports. The value for the PathName attribute for the Share resource must be on shared storage and it must be visible to all nodes in the cluster.

To create the NFS exports service group

- 1 Create an NFS Proxy resource inside the service group. This Proxy resource points to the actual NFS resource that is configured on the system.
- 2 If you configure the backing store for the NFS exports with VxVM, create DiskGroup and Mount resources for the mount point that you want to export.
Refer to Storage agents chapter of the *Cluster Server Bundled Agents Reference Guide* for details.
- 3 Create a Share resource. Set the PathName to the mount point that you want to export. In case of multiple shares, create multiple Share resources with different values for their PathName attributes.
- 4 Create an IP resource. The value of the Address attribute for this IP resource is used to mount the NFS exports on the client systems. Make the IP resource depend on the Share resources that are configured in the service group.

Sample configurations

The following are the sample configurations for some of the supported NFS configurations.

- See [“Sample configuration for a single NFS environment without lock recovery”](#) on page 270.
- See [“Sample configuration for a single NFS environment with lock recovery”](#) on page 272.
- See [“Sample configuration for a single NFSv4 environment”](#) on page 275.
- See [“Sample configuration for a multiple NFSv4 environment”](#) on page 277.
- See [“Sample configuration for a multiple NFS environment without lock recovery”](#) on page 280.
- See [“Sample configuration for a multiple NFS environment with lock recovery”](#) on page 282.
- See [“Sample configuration for configuring NFS with separate storage”](#) on page 286.
- See [“Sample configuration when configuring all NFS services in a parallel service group”](#) on page 288.

Sample configuration for a single NFS environment without lock recovery

```
include "types.cf"
cluster clus1 (
    UseFence = SCSI3
)
system sys1 (
)
system sys2 (
)
group sg11 (
    SystemList = { sys1 = 0, sys2 = 1 }
    AutoStartList = { sys1 }
)

DiskGroup vcs_dg1 (
    DiskGroup = dg1
    StartVolumes = 0
    StopVolumes = 0
)
```

```
IP ip_sys1 (
    Device @sys1 = en0
    Device @sys2 = en0
    Address = "10.198.90.198"
    NetMask = "255.255.248.0"
)

Mount vcs_dg1_r01_2 (
    MountPoint = "/testdir/VITA_dg1_r01_2"
    BlockDevice = "/dev/vx/dsk/dg1/dg1_r01_2"
    FSType = vxfs
    FsckOpt = "-y"
)

Mount vcs_dg1_r0_1 (
    MountPoint = "/testdir/VITA_dg1_r0_1"
    BlockDevice = "/dev/vx/dsk/dg1/dg1_r0_1"
    FSType = vxfs
    FsckOpt = "-y"
)

NFSRestart NFSRestart_sg11_L (
    NFSRes = nfs
    Lower = 1
)

NFSRestart NFSRestart_sg11_U (
    NFSRes = nfs
)

NIC nic_sg11_en0 (
    Device @sys1 = en0
    Device @sys2 = en0
    NetworkHosts = { "10.198.88.1" }
)

NFS nfs (
    Nservers = 16
)

Share share_dg1_r01_2 (
    PathName = "/testdir/VITA_dg1_r01_2"
```

```
Options = rw
)

Share share_dg1_r0_1 (
  PathName = "/testdir/VITA_dg1_r0_1"
  Options = rw
)

Volume vol_dg1_r01_2 (
  Volume = dg1_r01_2
  DiskGroup = dg1
)

Volume vol_dg1_r0_1 (
  Volume = dg1_r0_1
  DiskGroup = dg1
)

NFSRestart_sg11_L requires nfs
NFSRestart_sg11_L requires vcs_dg1_r01_2
NFSRestart_sg11_L requires vcs_dg1_r0_1
NFSRestart_sg11_U requires ip_sys1
ip_sys1 requires nic_sg11_en0
ip_sys1 requires share_dg1_r01_2
ip_sys1 requires share_dg1_r0_1
share_dg1_r01_2 requires NFSRestart_sg11_L
share_dg1_r0_1 requires NFSRestart_sg11_L
vcs_dg1_r01_2 requires vol_dg1_r01_2
vcs_dg1_r0_1 requires vol_dg1_r0_1
vol_dg1_r01_2 requires vcs_dg1
vol_dg1_r0_1 requires vcs_dg1
```

Sample configuration for a single NFS environment with lock recovery

```
include "types.cf"

cluster clus1 (
  UseFence = SCSI3
)

system sys1 (
)
```

```
system sys2 (
)
group sg11 (
  SystemList = { sys1 = 0, sys2 = 1 }
  AutoStartList = { sys1 }
)

DiskGroup vcs_dg1 (
  DiskGroup = dg1
  StartVolumes = 0
  StopVolumes = 0
)

IP ip_sys1 (
  Device @sys1 = en0
  Device @sys2 = en0
  Address = "10.198.90.198"
  NetMask = "255.255.248.0"
)

DNS dns_11 (
  Domain = "oradb.sym"
  TSIGKeyFile = "/Koradb.sym.+157+13021.private"
  StealthMasters = { "10.198.90.202" }
  ResRecord @sys1 = { sys1 = "10.198.90.198" }
  ResRecord @sys2 = { sys2 = "10.198.90.198" }
  CreatePTR = 1
  OffDelRR = 1
)

Mount vcs_dg1_r01_2 (
  MountPoint = "/testdir/VITA_dg1_r01_2"
  BlockDevice = "/dev/vx/dsk/dg1/dg1_r01_2"
  FSType = vxfs
  FsckOpt = "-y"
)

Mount vcs_dg1_r0_1 (
  MountPoint = "/testdir/VITA_dg1_r0_1"
  BlockDevice = "/dev/vx/dsk/dg1/dg1_r0_1"
  FSType = vxfs
  FsckOpt = "-y"
)
```

```
NFS nfs (
)

NFSRestart NFSRestart_sg11_L (
  NFSRes = nfs
  LocksPathName = "/testdir/VITA_dg1_r01_2"
  NFSLockFailover = 1
  Lower = 1
)

NFSRestart NFSRestart_sg11_U (
  NFSRes = nfs
  LocksPathName = "/testdir/VITA_dg1_r01_2"
  NFSLockFailover = 1
)

NIC nic_sg11_en0 (
  Device @sys1 = en0
  Device @sys2 = en0
  NetworkHosts = { "10.198.88.1" }
)

Share share_dg1_r01_2 (
  PathName = "/testdir/VITA_dg1_r01_2"
  Options = rw
)

Share share_dg1_r0_1 (
  PathName = "/testdir/VITA_dg1_r0_1"
  Options = rw
)

Volume vol_dg1_r01_2 (
  Volume = dg1_r01_2
  DiskGroup = dg1
)

Volume vol_dg1_r0_1 (
  Volume = dg1_r0_1
  DiskGroup = dg1
)

NFSRestart_sg11_L requires nfs
```

```
NFSRestart_sg11_L requires vcs_dg1_r01_2
NFSRestart_sg11_L requires vcs_dg1_r0_1
NFSRestart_sg11_U requires dns_11
dns_11 requires ip_sys1
ip_sys1 requires nic_sg11_en0
ip_sys1 requires share_dg1_r01_2
ip_sys1 requires share_dg1_r0_1
share_dg1_r01_2 requires NFSRestart_sg11_L
share_dg1_r0_1 requires NFSRestart_sg11_L
vcs_dg1_r01_2 requires vol_dg1_r01_2
vcs_dg1_r0_1 requires vol_dg1_r0_1
vol_dg1_r01_2 requires vcs_dg1
vol_dg1_r0_1 requires vcs_dg1
```

Sample configuration for a single NFSv4 environment

```
include "types.cf"
cluster clus1 (
    UseFence = SCSI3
)
system sys1 (
)
system sys2 (
)
group sg11 (
    SystemList = { sys1 = 0, sys2 = 1 }
    AutoStartList = { sys1 }
)
DiskGroup vcs_dg1 (
    DiskGroup = dg1
    StartVolumes = 0
    StopVolumes = 0
)
IP ip_sys1 (
    Device @sys1 = en0
    Device @sys2 = en0
    Address = "10.198.90.198"
    NetMask = "255.255.248.0"
)
DNS dns_11 (
    Domain = "oradb.sym"
    TSIGKeyFile = "/Koradb.sym.+157+13021.private"
    StealthMasters = { "10.198.90.202" }
```

```
ResRecord @sys1 = { sys1 = "10.198.90.198" }
ResRecord @sys2 = { sys2 = "10.198.90.198" }
CreatePTR = 1
OffDelRR = 1
)
Mount vcs_dg1_r01_2 (
  MountPoint = "/testdir/VITA_dg1_r01_2"
  BlockDevice = "/dev/vx/dsk/dg1/dg1_r01_2"
  FSType = vxfs
  FsckOpt = "-y"
)
Mount vcs_dg1_r0_1 (
  MountPoint = "/testdir/VITA_dg1_r0_1"
  BlockDevice = "/dev/vx/dsk/dg1/dg1_r0_1"
  FSType = vxfs
  FsckOpt = "-y"
)

NFS nfs (
  NFSv4Root = "/"
)

NFSRestart NFSRestart_sg11_L (
  NFSRes = nfs
  LocksPathName = "/testdir/VITA_dg1_r01_2"
  NFSLockFailover = 1
  Lower = 1
)
NFSRestart NFSRestart_sg11_U (
  NFSRes = nfs
  LocksPathName = "/testdir/VITA_dg1_r01_2"
  NFSLockFailover = 1
)
NIC nic_sg11_en0 (
  Device @sys1 = en0
  Device @sys2 = en0
  NetworkHosts = { "10.198.88.1" }
  NetworkType = ether
)
Share share_dg1_r01_2 (
  PathName = "/testdir/VITA_dg1_r01_2"
  Options = rw
)
```



```
Share share_dg1_r0_1 (
    PathName = "/testdir/VITA_dg1_r0_1"
    Options = rw
)
Volume vol_dg1_r01_2 (
    Volume = dg1_r01_2
    DiskGroup = dg1
)
Volume vol_dg1_r0_1 (
    Volume = dg1_r0_1
    DiskGroup = dg1
)
NFSRestart_sg11_L requires nfs
NFSRestart_sg11_L requires vcs_dg1_r01_2
NFSRestart_sg11_L requires vcs_dg1_r0_1
NFSRestart_sg11_U requires dns_11
dns_11 requires ip_sys1
ip_sys1 requires nic_sg11_en0
ip_sys1 requires share_dg1_r01_2
ip_sys1 requires share_dg1_r0_1
share_dg1_r01_2 requires NFSRestart_sg11_L
share_dg1_r0_1 requires NFSRestart_sg11_L
vcs_dg1_r01_2 requires vol_dg1_r01_2
vcs_dg1_r0_1 requires vol_dg1_r0_1
vol_dg1_r01_2 requires vcs_dg1
vol_dg1_r0_1 requires vcs_dg1
```

Sample configuration for a multiple NFSv4 environment

```
include "types.cf"
cluster clus1 (
    UseFence = SCSI3
)

system sys1 (
)
system sys2 (
)
group nfs_sg (
    SystemList = { sys1 = 0, sys2 = 1 }
    Parallel = 1
    AutoStartList = { sys1, sys2 }
)
```

```
NFS n1 (
    Nservers = 6
    NFSv4Root = "/"
)

Phantom ph1 (
)

group sg11 (
    SystemList = { sys1 = 0, sys2 = 1 }
    AutoStartList = { sys1 }
)

DiskGroup vcs_dg1 (
    DiskGroup = dg1
    StartVolumes = 0
    StopVolumes = 0
)

DNS dns_11 (
    Domain = "oradb.sym"
    TSIGKeyFile = "/Koradb.sym.+157+13021.private"
    StealthMasters = { "10.198.90.202" }
    ResRecord @sys1 = { sys1 = "10.198.90.198" }
    ResRecord @sys2 = { sys2 = "10.198.90.198" }
    CreatePTR = 1
    OffDelRR = 1
)

IP ip_sys2 (
    Device @sys1 = en0
    Device @sys2 = en0
    Address = "10.198.90.198"
    NetMask = "255.255.248.0"
)

Mount vcs_dg1_r01_2 (
    MountPoint = "/testdir/VITA_dg1_r01_2"
    BlockDevice = "/dev/vx/dsk/dg1/dg1_r01_2"
    FSType = vxfs
    FsckOpt = "-y"
)

Mount vcs_dg1_r0_1 (
    MountPoint = "/testdir/VITA_dg1_r0_1"
    BlockDevice = "/dev/vx/dsk/dg1/dg1_r0_1"
    FSType = vxfs
    FsckOpt = "-y"
)
```

```

NFSRestart NFSRestart_sg11_L (
    NFSRes = n1
    Lower = 1
    LocksPathName = "/testdir/VITA_dg1_r01_2"
    NFSLockFailover = 1
)
NFSRestart NFSRestart_sg11_U (
    NFSRes = n1
    LocksPathName = "/testdir/VITA_dg1_r01_2"
    NFSLockFailover = 1
)
NIC nic_sg11_en0 (
    Device @sys1 = en0
    Device @sys2 = en0
    NetworkHosts = { "10.198.88.1" }
)
Proxy p11 (
    TargetResName = n1
)
Share share_dg1_r01_2 (
    PathName = "/testdir/VITA_dg1_r01_2"
    Options = rw
)
Share share_dg1_r0_1 (
    PathName = "/testdir/VITA_dg1_r0_1"
    Options = rw
)
Volume vol_dg1_r01_2 (
    Volume = dg1_r01_2
    DiskGroup = dg1
)
Volume vol_dg1_r0_1 (
    Volume = dg1_r0_1
    DiskGroup = dg1
)
requires group nfs_sg online local firm
NFSRestart_sg11_L requires p11
NFSRestart_sg11_L requires vcs_dg1_r01_2
NFSRestart_sg11_L requires vcs_dg1_r0_1
NFSRestart_sg11_U requires dns_11
dns_11 requires ip_sys1
ip_sys1 requires nic_sg11_en0
ip_sys1 requires share_dg1_r01_2
    
```

```
ip_sys1 requires share_dg1_r0_1
share_dg1_r01_2 requires NFSRestart_sg11_L
share_dg1_r0_1 requires NFSRestart_sg11_L
vcs_dg1_r01_2 requires vol_dg1_r01_2
vcs_dg1_r0_1 requires vol_dg1_r0_1
vol_dg1_r01_2 requires vcs_dg1
vol_dg1_r0_1 requires vcs_dg1
```

Sample configuration for a multiple NFS environment without lock recovery

```
include "types.cf"

cluster clus1 (
    UseFence = SCSI3
)

system sys1 (
)

system sys2 (
)

group nfs_sg (
    SystemList = { sys1 = 0, sys2 = 1 }
    Parallel = 1
    AutoStartList = { sys1, sys2 }
)

NFS n1 (
    Nservers = 6
)

Phantom ph1 (
)

group sg11 (
    SystemList = { sys1 = 0, sys2 = 1 }
    AutoStartList = { sys1 }
)
```

```
DiskGroup vcs_dg1 (  
    DiskGroup = dg1  
    StartVolumes = 0  
    StopVolumes = 0  
)  
  
IP ip_sys1 (  
    Device @sys1 = en0  
    Device @sys2 = en0  
    Address = "10.198.90.198"  
    NetMask = "255.255.248.0"  
)  
  
Mount vcs_dg1_r01_2 (  
    MountPoint = "/testdir/VITA_dg1_r01_2"  
    BlockDevice = "/dev/vx/dsk/dg1/dg1_r01_2"  
    FSType = vxfs  
    FsckOpt = "-y"  
)  
  
Mount vcs_dg1_r0_1 (  
    MountPoint = "/testdir/VITA_dg1_r0_1"  
    BlockDevice = "/dev/vx/dsk/dg1/dg1_r0_1"  
    FSType = vxfs  
    FsckOpt = "-y"  
)  
  
NFSRestart NFSRestart_sg11_L (  
    NFSRes = n1  
    Lower = 1  
)  
  
NFSRestart NFSRestart_sg11_U (  
    NFSRes = n1  
)  
  
NIC nic_sg11_en0 (  
    Device @sys1 = en0  
    Device @sys2 = en0  
    NetworkHosts = { "10.198.88.1" }  
)  
  
Proxy p11 (  

```

```
        TargetResName = n1
    )

Share share_dg1_r01_2 (
    PathName = "/testdir/VITA_dg1_r01_2"
    Options = rw
)

Share share_dg1_r0_1 (
    PathName = "/testdir/VITA_dg1_r0_1"
    Options = rw
)

Volume vol_dg1_r01_2 (
    Volume = dg1_r01_2
    DiskGroup = dg1
)

Volume vol_dg1_r0_1 (
    Volume = dg1_r0_1
    DiskGroup = dg1
)

requires group nfs_sg online local firm
NFSRestart_sg11_L requires p11
NFSRestart_sg11_L requires vcs_dg1_r01_2
NFSRestart_sg11_L requires vcs_dg1_r0_1
NFSRestart_sg11_U requires ip_sys1
ip_sys1 requires nic_sg11_en0
ip_sys1 requires share_dg1_r01_2
ip_sys1 requires share_dg1_r0_1
share_dg1_r01_2 requires NFSRestart_sg11_L
share_dg1_r0_1 requires NFSRestart_sg11_L
vcs_dg1_r01_2 requires vol_dg1_r01_2
vcs_dg1_r0_1 requires vol_dg1_r0_1
vol_dg1_r01_2 requires vcs_dg1
vol_dg1_r0_1 requires vcs_dg1
```

Sample configuration for a multiple NFS environment with lock recovery

```
include "types.cf"
```

```
cluster clus1 (
    UseFence = SCSI3
)

system sys1 (
)

system sys2 (
)

group nfs_sg (
    SystemList = { sys1 = 0, sys2 = 1 }
    Parallel = 1
    AutoStartList = { sys1, sys2 }
)

NFS n1 (
    Nservers = 6
)

Phantom ph1 (
)

group sg11 (
    SystemList = { sys1 = 0, sys2 = 1 }
    AutoStartList = { sys1 }
)

DiskGroup vcs_dg1 (
    DiskGroup = dg1
    StartVolumes = 0
    StopVolumes = 0
)

DNS dns_11 (
    Domain = "oradb.sym"
    TSIGKeyFile = "/Koradb.sym.+157+13021.private"
    StealthMasters = { "10.198.90.202" }
    ResRecord @sys1 = { sys1 = "10.198.90.198" }
    ResRecord @sys2 = { sys2 = "10.198.90.198" }
    CreatePTR = 1
)
```

```
    OffDelRR = 1
  )

IP ip_sys1 (
  Device @sys1 = en0
  Device @sys2 = en0
  Address = "10.198.90.198"
  NetMask = "255.255.248.0"
)

Mount vcs_dg1_r01_2 (
  MountPoint = "/testdir/VITA_dg1_r01_2"
  BlockDevice = "/dev/vx/dsk/dg1/dg1_r01_2"
  FSType = vxfs
  FsckOpt = "-y"
)

Mount vcs_dg1_r0_1 (
  MountPoint = "/testdir/VITA_dg1_r0_1"
  BlockDevice = "/dev/vx/dsk/dg1/dg1_r0_1"
  FSType = vxfs
  FsckOpt = "-y"
)

NFSRestart NFSRestart_sg11_L (
  NFSRes = n1
  Lower = 1
  LocksPathName = "/testdir/VITA_dg1_r01_2"
  NFSLockFailover = 1
)

NFSRestart NFSRestart_sg11_U (
  NFSRes = n1
  LocksPathName = "/testdir/VITA_dg1_r01_2"
  NFSLockFailover = 1
)

NIC nic_sg11_en0 (
  Device @sys1 = en0
  Device @sys2 = en0
  NetworkHosts = { "10.198.88.1" }
)

Proxy p11 (
```



```
    TargetResName = n1
  )

Share share_dg1_r01_2 (
  PathName = "/testdir/VITA_dg1_r01_2"
  Options = rw
)

Share share_dg1_r0_1 (
  PathName = "/testdir/VITA_dg1_r0_1"
  Options = rw
)

Volume vol_dg1_r01_2 (
  Volume = dg1_r01_2
  DiskGroup = dg1
)

Volume vol_dg1_r0_1 (
  Volume = dg1_r0_1
  DiskGroup = dg1
)

requires group nfs_sg online local firm
NFSRestart_sg11_L requires p11
NFSRestart_sg11_L requires vcs_dg1_r01_2
NFSRestart_sg11_L requires vcs_dg1_r0_1
NFSRestart_sg11_U requires dns_11
dns_11 requires ip_sys1
ip_sys1 requires nic_sg11_en0
ip_sys1 requires share_dg1_r01_2
ip_sys1 requires share_dg1_r0_1
share_dg1_r01_2 requires NFSRestart_sg11_L
share_dg1_r0_1 requires NFSRestart_sg11_L
vcs_dg1_r01_2 requires vol_dg1_r01_2
vcs_dg1_r0_1 requires vol_dg1_r0_1
vol_dg1_r01_2 requires vcs_dg1
vol_dg1_r0_1 requires vcs_dg1
```

Sample configuration for configuring NFS with separate storage

```
include "types.cf"

cluster clus1 (
    UseFence = SCSI3
)

system sys1 (
)

system sys2 (
)

group nfs_sg (
    SystemList = { sys1 = 0, sys2 = 1 }
    Parallel = 1
    AutoStartList = { sys1, sys2 }
)

NFS n1 (
    Nservers = 6
)

Phantom ph1 (
)

group sg11storage (
    SystemList = { sys1 = 0, sys2 = 1 }
)

DiskGroup vcs_dg1 (
    DiskGroup = dg1
    StartVolumes = 0
    StopVolumes = 0
)

Mount vcs_dg1_r01_2 (
    MountPoint = "/testdir/VITA_dg1_r01_2"
    BlockDevice = "/dev/vx/dsk/dg1/dg1_r01_2"
    FSType = vxfs
    FsckOpt = "-y"
)
```

```
Mount vcs_dg1_r0_1 (
    MountPoint = "/testdir/VITA_dg1_r0_1"
    BlockDevice = "/dev/vx/dsk/dg1/dg1_r0_1"
    FSType = vxfs
    FsckOpt = "-y"
)

Volume vol_dg1_r01_2 (
    Volume = dg1_r01_2
    DiskGroup = dg1
)

Volume vol_dg1_r0_1 (
    Volume = dg1_r0_1
    DiskGroup = dg1
)

vcs_dg1_r01_2 requires vol_dg1_r01_2
vcs_dg1_r0_1 requires vol_dg1_r0_1
vol_dg1_r01_2 requires vcs_dg1
vol_dg1_r0_1 requires vcs_dg1

group sg11 (
    SystemList = { sys1 = 0, sys2 = 1 }
    AutoStartList = { sys1 }
)

IP sys1 (
    Device @sys1 = en0
    Device @sys2 = en0
    Address = "10.198.90.198"
    NetMask = "255.255.248.0"
)

NFSRestart NFSRestart_sg11_L (
    NFSRes = n1
    Lower = 1
)

NFSRestart NFSRestart_sg11_U (
    NFSRes = n1
)
```

```
NIC nic_sg11_en0 (
    Device @sys1 = en0
    Device @sys2 = en0
    NetworkHosts = { "10.198.88.1" }
)

Proxy p11 (
    TargetResName = n1
)

Share share_dg1_r01_2 (
    PathName = "/testdir/VITA_dg1_r01_2"
    Options = rw
)

Share share_dg1_r0_1 (
    PathName = "/testdir/VITA_dg1_r0_1"
    Options = rw
)

requires group sg11storage online local hard
NFSRestart_sg11_L requires p11
NFSRestart_sg11_U requires ip_sys1
ip_sys1 requires nic_sg11_en0
ip_sys1 requires share_dg1_r01_2
ip_sys1 requires share_dg1_r0_1
share_dg1_r01_2 requires NFSRestart_sg11_L
share_dg1_r0_1 requires NFSRestart_sg11_L
```

Sample configuration when configuring all NFS services in a parallel service group

```
include "types.cf"

cluster clus1 (
    UseFence = SCSI3
)

system sys1 (
)

system sys2 (
)
```

```
group nfs_sg (
    SystemList = { sys1 = 0, sys2 = 1 }
    Parallel = 1
    AutoStartList = { sys1, sys2 }
)

NFS n1 (
    Nservers = 6
)

NFSRestart nfsrestart (
    NFSRes = n1
    Lower = 2
)

nfsrestart requires n1

group sg11 (
    SystemList = { sys1 = 0, sys2 = 1 }
    AutoStartList = { sys1 }
)

IP ip_sys1 (
    Device @sys1 = en0
    Device @sys2 = en0
    Address = "10.198.90.198"
    NetMask = "255.255.248.0"
)

NIC nic_sg11_en0 (
    Device @sys1 = en0
    Device @sys2 = en0
    NetworkHosts = { "10.198.88.1" }
)

Proxy p11 (
    TargetResName = n1
)

Share share_dg1_r01_2 (
    PathName = "/testdir/VITA_dg1_r01_2"
```

```
Options = rw
)

Share share_dg1_r0_1 (
    PathName = "/testdir/VITA_dg1_r0_1"
    Options = rw
)

requires group sg11storage online local hard
ip_sys1 requires nic_sg11_en0
ip_sys1 requires share_dg1_r01_2
ip_sys1 requires share_dg1_r0_1
share_dg1_r01_2 requires p11
share_dg1_r0_1 requires p11

group sg11storage (
    SystemList = { sys1 = 0, sys2 = 1 }
)

DiskGroup vcs_dg1 (
    DiskGroup = dg1
    StartVolumes = 0
    StopVolumes = 0
)

Mount vcs_dg1_r01_2 (
    MountPoint = "/testdir/VITA_dg1_r01_2"
    BlockDevice = "/dev/vx/dsk/dg1/dg1_r01_2"
    FSType = vxfs
    FsckOpt = "-y"
)

Mount vcs_dg1_r0_1 (
    MountPoint = "/testdir/VITA_dg1_r0_1"
    BlockDevice = "/dev/vx/dsk/dg1/dg1_r0_1"
    FSType = vxfs
    FsckOpt = "-y"
)

Volume vol_dg1_r01_2 (
    Volume = dg1_r01_2
    DiskGroup = dg1
)
```

```
Volume vol_dg1_r0_1 (  
    Volume = dg1_r0_1  
    DiskGroup = dg1  
)  
  
vcs_dg1_r01_2 requires vol_dg1_r01_2  
vcs_dg1_r0_1 requires vol_dg1_r0_1  
vol_dg1_r01_2 requires vcs_dg1  
vol_dg1_r0_1 requires vcs_dg1
```

About configuring the RemoteGroup agent

The RemoteGroup agent monitors and manages service groups in a remote cluster. Use the RemoteGroup agent to establish dependencies between applications that are configured on different VCS clusters.

For example, you configure an Apache resource in a local cluster, and configure an Oracle resource in a remote cluster. In this example, the Apache resource in the local cluster depends on the Oracle resource in the remote cluster. You can use the RemoteGroup agent to establish this dependency between the service groups that contain the Apache resource and the Oracle resource, if you add the RemoteGroup agent as a resource in the Apache service group.

See the *Cluster Server Bundled Agents Reference Guide* for more information about the agent and its attributes.

Note: RemoteGroup agent configurations and Virtual Business Service configurations are mutually exclusive though both provide multi-tier application support.

For information about Virtual Business Services, see the *Virtual Business Service–Availability User's Guide*.

See [“Adding a RemoteGroup resource from the Java Console”](#) on page 146.

About the ControlMode attribute

In the ControlMode attribute, you can use these values, depending on your needs: OnOff, MonitorOnly, and OnlineOnly.

About the OnOff mode

Select the OnOff value of this attribute when you want the RemoteGroup resource to manage the remote service group completely.

In case of one-to-one mapping, set the value of the AutoFailOver attribute of the remote service group to 0. This avoids unnecessary onlining or offlining of the remote service group.

About the MonitorOnly mode

Select the MonitorOnly value of this attribute when you want to monitor the state of the remote service group. When you choose the MonitorOnly attribute, the RemoteGroup agent does not have control over the remote service group and cannot bring it online or take it offline.

The remote service group should be in an ONLINE state before you bring the RemoteGroup resource online.

Veritas recommends that the AutoFailOver attribute of the remote service group be set to 1.

About the OnlineOnly mode

Select the OnlineOnly value of this attribute when the remote service group takes a long time to come online or to go offline. When you use OnlineOnly for the ControlMode attribute, a switch or fail over of the local service group with VCSSysName set to ANY does not cause the remote service group to be taken offline and brought online.

Taking the RemoteGroup resource offline does not take the remote service group offline.

If you choose one-to-one mapping between the local nodes and remote nodes, then the value of the AutoFailOver attribute of the remote service group must be 0.

Note: When you set the value of ControlMode to OnlineOnly or to MonitorOnly, the recommend value of the VCSSysName attribute of the RemoteGroup resource is ANY. If you want one-to-one mapping between the local nodes and the remote nodes, then a switch or fail over of local service group is impossible. It is important to note that in both these configurations the RemoteGroup agent does not take the remote service group offline.

About the ReturnIntOffline attribute

The ReturnIntOffline attribute can take one of three values: RemotePartial, RemoteOffline, and RemoteFaulted.

These values are not mutually exclusive and can be used in combination with one another. You must set the IntentionalOffline attribute of RemoteGroup resource to 1 for the ReturnIntOffline attribute to work.

About the RemotePartial option

Select the RemotePartial value of this attribute when you want the RemoteGroup resource to return an IntentionalOffline when the remote service group is in an ONLINE | PARTIAL state.

About the RemoteOffline option

Select the RemoteOffline value of this attribute when you want the RemoteGroup resource to return an IntentionalOffline when the remote service group is in an OFFLINE state.

About the RemoteFaulted option

Select the RemoteFaulted value of this attribute when you want the RemoteGroup resource to return an IntentionalOffline when the remote service group is in an OFFLINE | FAULTED state.

Configuring a RemoteGroup resource

This topic describes how to configure a RemoteGroup resource.

In this example configuration, the following is true:

- VCS cluster (cluster1) provides high availability for Web services.
Configure a VCS service group (ApacheGroup) with an agent to monitor the Web server (for example Apache) to monitor the Web services.
- VCS cluster (cluster2) provides high availability for the database required by the Web-services.
Configure a VCS service group (OracleGroup) with a database agent (for example Oracle) to monitor the database.

The database resource must come online before the Web server comes online. You create this dependency using the RemoteGroup agent.

To configure the RemoteGroup agent

- 1 Add a RemoteGroup resource in the ApacheGroup service group (in cluster 1).
- 2 Link the resources such that the Web server resource depends on the RemoteGroup resource.
- 3 Configure the following RemoteGroup resource items to monitor or manage the service group that contains the database resource:
 - **IpAddress:**
Set to the IP address or DNS name of a node in cluster2. You can also set this to a virtual IP address.
 - **GroupName**
Set to OracleGroup.
 - **ControlMode**
Set to OnOff.
 - **Username**
Set to the name of a user having administrative privileges for OracleGroup.
 - **Password**
Encrypted password for defined in Username. Encrypt the password using the `vcscrypt -agent` command.
 - **VCSSysName**
Set to local, per-node values.
VCSSysName@local1—Set this value to remote1.
VCSSysName@local2—Set this value to remote2.

Note: If the remote cluster runs in secure mode, you must set the value for DomainType or BrokerIp attributes.

- 4 Set the value of the AutoFailOver attribute of the OracleGroup to 0.

Service group behavior with the RemoteGroup agent

Consider the following potential actions to better understand this solution.

Bringing the Apache service group online

Following are the dependencies to bring the Apache service group online:

- The Apache resource depends on the RemoteGroup resource.

- The RemoteGroup agent communicates to the remote cluster and authenticates the specified user.
- The RemoteGroup agent brings the database service group online in cluster2.
- The Apache resource comes online after the RemoteGroup resource is online.

Thus, you establish an application-level dependency across two different VCS clusters. The Apache resource does not go online unless the RemoteGroup goes online. The RemoteGroup resource does not go online unless the database service group goes online.

Unexpected offline of the database service group

Following are the sequence of actions when the database service group is unexpectedly brought offline:

- The RemoteGroup resource detects that the database group has gone OFFLINE or has FAULTED.
- The RemoteGroup resource goes into a FAULTED state.
- All the resources in the Apache service group are taken offline on the node.
- The Apache group fails over to another node.
- As part of the fail over, the Oracle service group goes online on another node in cluster2.

Taking the Apache service group offline

Following are the sequence of actions when the Apache service group is taken offline:

- All the resources dependant on the RemoteGroup resource are taken offline.
- The RemoteGroup agent tries to take the Oracle service group offline.
- Once the Oracle service group goes offline, the RemoteGroup goes offline.

Thus, the Web server is taken offline before the database goes offline.

Configuring RemoteGroup resources in parallel service groups

When a RemoteGroup resource is configured inside parallel service groups, it can come online on all the cluster nodes, including the offline nodes. Multiple instances of the RemoteGroup resource on cluster nodes can probe the state of a remote service group.

Note: The RemoteGroup resource automatically detects whether it is configured for a parallel service group or for a failover service group. No additional configuration is required to enable the RemoteGroup resource for parallel service groups.

A RemoteGroup resource in parallel service groups has the following characteristics:

- The RemoteGroup resource continues to monitor the remote service group even when the resource is offline.
- The RemoteGroup resource does not take the remote service group offline if the resource is online anywhere in the cluster.
- After an agent restarts, the RemoteGroup resource does not return offline if the resource is online on another cluster node.
- The RemoteGroup resource takes the remote service group offline if it is the only instance of RemoteGroup resource online in the cluster.
- An attempt to bring a RemoteGroup resource online has no effect if the same resource instance is online on another node in the cluster.

About configuring Samba service groups

You can configure Samba in parallel configurations or failover configurations with VCS.

Refer to the *Cluster Server Bundled Agents Reference Guide* for platform-specific details and examples of the attributes of the Samba family of agents.

Sample configuration for Samba in a failover configuration

The configuration contains a failover service group containing SambaServer, NetBios, IP, NIC, and SambaShare resources. You can configure the same NetBiosName and Interfaces attribute values for all nodes because the resource comes online only on one node at a time.

```
include "types.cf"

cluster clus1 (
)

system sys1(
)

system sys2(
)
```

```
group smbserver (
    SystemList = { sys1= 0, sys2= 1 }
)

IP ip (
    Device = en0
    Address = "10.209.114.201"
    NetMask = "255.255.252.0"
)

NIC nic (
    Device = en0
    NetworkHosts = { "10.209.74.43" }
)

NetBios nmb (
    SambaServerRes = smb
    NetBiosName = smb_vcs
    Interfaces = { "10.209.114.201" }
)

SambaServer smb (
    ConfFile = "/etc/samba/smb.conf"
    LockDir = "/var/run"
    SambaTopDir = "/usr"
)

SambaShare smb_share (
    SambaServerRes = smb
    ShareName = share1
    ShareOptions = "path = /samba_share/; public = yes;
        writable = yes"
)

ip requires nic
nmb requires smb
smb requires ip
smb_share requires nmb
```

Configuring the Coordination Point agent

To monitor I/O fencing coordination points, configure the Coordination Point agent in the VCS cluster where you have configured I/O fencing.

For server-based fencing, you can either use the `-fencing` option of the installer to configure the agent or you can manually configure the agent. For disk-based fencing, you must manually configure the agent.

See the *Cluster Server Bundled Agents Reference Guide* for more information on the agent.

See the *Cluster Server Installation Guide* for instructions to configure the agent.

About migration of data from LVM volumes to VxVM volumes

VCS supports online migration of data from LVM volumes to VxVM volumes in VCS HA environments.

You can run the `vxmigadm` utility to migrate data from LVM volumes to VxVM volumes. The `vxmigadm` utility integrates seamlessly with VCS, which monitors the LVM volumes. During the data migration, the `vxmigadm` utility adds new resources to monitor the VxVM disk group and VxVM volumes. It keeps track of the dependencies among VCS resources and makes the required updates to these dependencies. When migration is complete, the dependency of any application on LVM volumes is removed.

For more information, see the *Veritas InfoScale 7.1 Solutions Guide*.

About testing resource failover by using HA fire drills

Configuring high availability for a database or an application requires several infrastructure and configuration settings on multiple systems. However, cluster environments are subject to change after the initial setup. Administrators add disks, create new disk groups and volumes, add new cluster nodes, or new NICs to upgrade and maintain the infrastructure. Keeping the cluster configuration updated with the changing infrastructure is critical.

HA fire drills detect discrepancies between the VCS configuration and the underlying infrastructure on a node; discrepancies that might prevent a service group from going online on a specific node.

See the *Cluster Server Bundled Agents Reference Guide* for information on which agents support HA fire drills.

About HA fire drills

The HA fire drill (earlier known as virtual fire drill) feature uses the Action function associated with the agent. The Action functions of the supported agents are updated to support the HA fire drill functionality—running infrastructure checks and fixing specific errors.

The infrastructure check verifies the resources defined in the VCS configuration file (`main.cf`) have the required infrastructure to fail over on another node. For example, an infrastructure check for the Mount resource verifies the existence of the mount directory defined in the MountPoint attribute for the resource.

You can run an infrastructure check only when the service group is online. The check verifies that the specified node is a viable failover target capable of hosting the service group.

The HA fire drill provides an option to fix specific errors detected during the infrastructure check.

About running an HA fire drill

You can run a HA fire drill from the command line or from Cluster Manager (Java Console).

See [“Running HA fire drill from the Java Console”](#) on page 158.

See [“Running HA fire drills”](#) on page 251.

Predicting VCS behavior using VCS Simulator

This chapter includes the following topics:

- [About VCS Simulator](#)
- [VCS Simulator ports](#)
- [Administering VCS Simulator from the command line interface](#)

About VCS Simulator

VCS Simulator enables you to simulate and test cluster configurations. Use VCS Simulator to view and modify service group and resource configurations and test failover behavior. VCS Simulator can be run on a stand-alone system and does not require any additional hardware.

VCS Simulator runs an identical version of the VCS High Availability Daemon (HAD) as in a cluster, ensuring that failover decisions are identical to those in an actual cluster.

You can test configurations from different operating systems using VCS Simulator. The VCS simulator can run only on Windows systems. However, it can simulate non-Windows operating systems on a Windows system. For example, you can run VCS Simulator on a Windows system and test VCS configurations for Windows, Linux, Solaris, HP-UX, and AIX clusters. VCS Simulator also enables creating and testing global clusters.

You can administer VCS Simulator from the Java Console or from the command line.

To download VCS Simulator, go to <https://www.veritas.com/product/storage-management>.

VCS Simulator ports

[Table 8-1](#) lists the ports that VCS Simulator uses to connect to the various cluster configurations. You can modify cluster configurations to adhere to your network policies. Also, Veritas might change port assignments or add new ports based on the number of VCS Simulator configurations.

Table 8-1 VCS Simulator ports

Port	Usage
15552	SOL_ORA_SRDF_C1:simulatorport
15553	SOL_ORA_SRDF_C2:simulatorport
15554	SOL_ORACLE:simulatorport
15555	LIN_NFS:simulatorport
15556	HP_NFS:simulatorport
15557	AIX_NFS:simulatorport
15558	Consolidation:simulatorport
15559	SOL_NPLUS1:simulatorport
15572	AcmePrimarySite:simulatorport
15573	AcmeSecondarySite:simulatorport
15580	Win_Exch_2K7_primary:simulatorport
15581	Win_Exch_2K7_secondary:simulatorport
15582	WIN_NTAP_EXCH_CL1:simulatorport
15583	WIN_NTAP_EXCH_CL2:simulatorport
15611	WIN_SQL2K5_VVR_C1:simulatorport
15612	WIN_SQL2K5_VVR_C2:simulatorport
15613	WIN_SQL2K8_VVR_C1:simulatorport
15614	WIN_SQL2K8_VVR_C2:simulatorport
15615	WIN_E2K10_VVR_C1:simulatorport
15616	WIN_E2K10_VVR_C2:simulatorport

Table 8-2 lists the ports that the VCS Simulator uses for the wide area connector (WAC) process. Set the WAC port to -1 to disable WAC simulation.

Table 8-2 WAC ports

Port	Usage
15562	SOL_ORA_SRDF_C1:wacport
15563	SOL_ORA_SRDF_C2:wacport
15566	Win_Exch_2K7_primary:wacport
15567	Win_Exch_2K7_secondary:wacport
15570	WIN_NTAP_EXCH_CL1:wacport
15571	WIN_NTAP_EXCH_CL2:wacport
15582	AcmePrimarySite:wacport
15583	AcmeSecondarySite:wacport
15661	WIN_SQL2K5_VVR_C1:wacport
15662	WIN_SQL2K5_VVR_C2:wacport
15663	WIN_SQL2K8_VVR_C1:wacport
15664	WIN_SQL2K8_VVR_C2:wacport
15665	WIN_E2K10_VVR_C1:wacport
15666	WIN_E2K10_VVR_C2:wacport

Administering VCS Simulator from the command line interface

Start VCS Simulator on a Windows system before creating or administering simulated clusters.

Note: VCS Simulator treats clusters that are created from the command line and the Java Console separately. Hence, clusters that are created from the command line are not visible in the graphical interface. If you delete a cluster from the command line, you may see the cluster in the Java Console.

Starting VCS Simulator from the command line interface

This topic describes how to start VCS simulator from the command line:

To start VCS Simulator from the command line (Windows)

VCS Simulator installs platform-specific `types.cf` files at the path `%VCS_SIMULATOR_HOME%\types\`. The variable `%VCS_SIMULATOR_HOME%` represents the VCS Simulator installation directory, typically `C:\Program Files\Veritas\VCS Simulator\`.

Example: `C:\DOS>set %VCS_SIMULATOR_HOME%=C:\Program Files\Veritas\VCS Simulator\`

- 1 To simulate a cluster running a particular operating system, copy the `types.cf` file for the operating system from the `types` directory to `%VCS_SIMULATOR_HOME%\default_clus\conf\config\`.

For example, if the cluster to be simulated runs on the AIX platform, copy the file `types.cf.aix`.

- 2 Add custom type definitions to the file, if required, and rename the file to `types.cf`.
- 3 If you have a `main.cf` file to run in the simulated cluster, copy it to `%VCS_SIMULATOR_HOME%\default_clus\conf\config\`.
- 4 Start VCS Simulator:

```
%VCS_SIMULATOR_HOME%\bin> hasim -start system_name
```

The variable `system_name` represents a system name, as defined in the configuration file `main.cf`.

This command starts VCS Simulator on port 14153.

- 5 Add systems to the configuration, if desired:

```
%VCS_SIMULATOR_HOME%\bin> hasim -sys -add system_name
```

```
%VCS_SIMULATOR_HOME%\bin> hasim -up system_name
```

- 6 Verify the state of each node in the cluster:

```
%VCS_SIMULATOR_HOME%\bin> hasim -sys -state
```

See [“To simulate global clusters from the command line”](#) on page 304.

To simulate global clusters from the command line

- 1 Install VCS Simulator in a directory (%VCS_SIMULATOR_HOME%) on your system.

See the section Installing VCS Simulator in the *Cluster Server Installation Guide*.

- 2 Set up the clusters on your system. Run the following command to add a cluster:

```
%VCS_SIMULATOR_HOME%\bin> hasim -setupclus new_clustername -simport
port_no -wacport port_no
```

Do not use default_clus as the cluster name when simulating a global cluster.

VCS Simulator copies the sample configurations to the path %VCS_SIMULATOR_HOME%\clustername and creates a system named clustername_sys1.

For example, to add cluster clus_a using ports 15555 and 15575, run the following command:

```
%VCS_SIMULATOR_HOME%\bin> hasim -setupclus clus_a -simport 15555
-wacport 15575
```

Similarly, add the second cluster:

```
%VCS_SIMULATOR_HOME%\bin> hasim -setupclus clus_b -simport 15556
-wacport 15576
```

To create multiple clusters without simulating a global cluster environment, specify -1 for the wacport.

- 3 Start the simulated clusters:

```
%VCS_SIMULATOR_HOME%\bin> hasim -start clustername_sys1
-clus clustername
```

- 4 Set the following environment variables to access VCS Simulator from the command line:

- set %VCS_SIM_PORT%=port_number
- set %VCS_SIM_WAC_PORT%=wacport

Note that you must set these variables for each simulated cluster, otherwise VCS Simulator always connects default_clus, the default cluster.

You can use the Java Console to link the clusters and to configure global service groups.

See [“About the Cluster Manager \(Java Console\)”](#) on page 91.

You can also edit the configuration file `main.cf` manually to create the global cluster configuration.

Administering simulated clusters from the command line

The functionality of VCS Simulator commands mimic that of standard ha commands.

[Table 8-3](#) describes the VCS simulator commands:

Table 8-3 VCS simulator commands

Command	Description
<code>hasim -start system_name</code>	Starts VCS Simulator. The variable <i>system_name</i> represents the system that will transition from the LOCAL_BUILD state to the RUNNING state.
<code>hasim -setupclus clustername -simport port_no [-wacport port_no] [-sys systemname]</code>	Creates a simulated cluster and associates the specified ports with the cluster.
<code>hasim -deleteclus <clus></code>	Deletes the specified cluster. Deleting the cluster removes all files and directories associated with the cluster. Before deleting a cluster, make sure the cluster is not configured as a global cluster.
<code>hasim -start clustername_sys1 [-clus clustername] [-disablel10n]</code>	Starts VCS Simulator on the cluster specified by <i>clustername</i> . If you start VCS Simulator with the <code>-disablel10n</code> option, the simulated cluster does not accept localized values for attributes. Use this option when simulating a UNIX configuration on a Windows system to prevent potential corruption when importing the simulated configuration to a UNIX cluster.
<code>hasim -stop</code>	Stops the simulation process.
<code>hasim -poweroff system_name</code>	Gracefully shuts down the system.
<code>hasim -up system_name</code>	Brings the system up.

Table 8-3 VCS simulator commands (*continued*)

Command	Description
<code>hasim -fault system_name resource_name</code>	Faults the specified resource on the specified system.
<code>hasim -faultcluster clustername</code>	Simulates a cluster fault.
<code>hasim -clearcluster clustername</code>	Clears a simulated cluster fault.
<code>hasim -getsimconfig cluster_name</code>	Retrieves information about VCS Simulator ports.
<code>hasim -hb [...]</code>	Equivalent to standard <code>hahb</code> command.
<code>hasim -disablel10n</code>	Disables localized inputs for attribute values. Use this option when simulating UNIX configurations on Windows systems.
<code>hasim -clus [...]</code>	Equivalent to standard <code>haclus</code> command.
<code>hasim -sys [...]</code>	Equivalent to standard <code>hasys</code> command.
<code>hasim -grp [...]</code>	Equivalent to standard <code>hagrps</code> command.
<code>hasim -res [...]</code>	Equivalent to standard <code>hares</code> command.
<code>hasim -type [...]</code>	Equivalent to standard <code>hatype</code> command.
<code>hasim -conf [...]</code>	Equivalent to standard <code>haconf</code> command.
<code>hasim -attr [...]</code>	Equivalent to standard <code>haattr</code> command.

VCS communication and operations

- [Chapter 9. About communications, membership, and data protection in the cluster](#)
- [Chapter 10. Administering I/O fencing](#)
- [Chapter 11. Controlling VCS behavior](#)
- [Chapter 12. The role of service group dependencies](#)

About communications, membership, and data protection in the cluster

This chapter includes the following topics:

- [About cluster communications](#)
- [About cluster membership](#)
- [About membership arbitration](#)
- [About data protection](#)
- [About I/O fencing configuration files](#)
- [Examples of VCS operation with I/O fencing](#)
- [About cluster membership and data protection without I/O fencing](#)
- [Examples of VCS operation without I/O fencing](#)
- [Summary of best practices for cluster communications](#)

About cluster communications

VCS uses local communications on a system and system-to-system communications.

See [“About intra-system communications”](#) on page 309.

See [“About inter-system cluster communications”](#) on page 309.

About intra-system communications

Within a system, the VCS engine (VCS High Availability Daemon) uses a VCS-specific communication protocol known as Inter Process Messaging (IPM) to communicate with the GUI, the command line, and the agents.

Figure 9-1 shows basic communication on a single VCS system. Note that agents only communicate with High Availability Daemon (HAD) and never communicate with each other.

Figure 9-1 Basic communication on a single VCS system

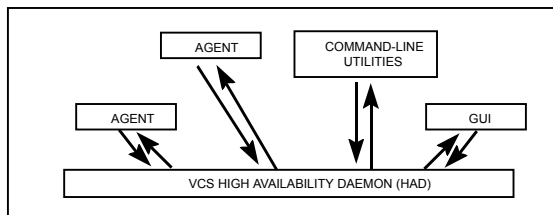
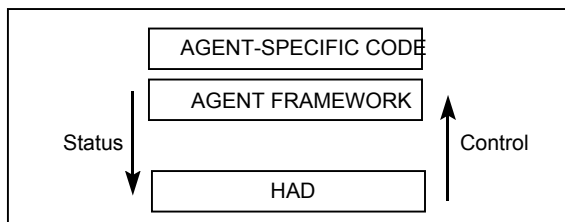

Figure 9-2 depicts communication from a single agent to HAD.

Figure 9-2 Communication from a single agent to HAD



The agent uses the agent framework, which is compiled into the agent itself. For each resource type configured in a cluster, an agent runs on each cluster system. The agent handles all resources of that type. The engine passes commands to the agent and the agent returns the status of command execution. For example, an agent is commanded to bring a resource online. The agent responds back with the success (or failure) of the operation. Once the resource is online, the agent communicates with the engine only if this status changes.

About inter-system cluster communications

VCS uses the cluster interconnect for network communications between cluster systems. Each system runs as an independent unit and shares information at the cluster level. On each system the VCS High Availability Daemon (HAD), which has the decision logic for the cluster, maintains a view of the cluster configuration. This

daemon operates as a replicated state machine, which means all systems in the cluster have a synchronized state of the cluster configuration. This is accomplished by the following:

- All systems run an identical version of HAD.
- HAD on each system maintains the state of its own resources, and sends all cluster information about the local system to all other machines in the cluster.
- HAD on each system receives information from the other cluster systems to update its own view of the cluster.
- Each system follows the same code path for actions on the cluster.

The replicated state machine communicates over a purpose-built communications package consisting of two components, Group Membership Services/Atomic Broadcast (GAB) and Low Latency Transport (LLT).

See [“About Group Membership Services/Atomic Broadcast \(GAB\)”](#) on page 310.

See [“About Low Latency Transport \(LLT\)”](#) on page 311.

[Figure 9-3](#) illustrates the overall communications paths between two systems of the replicated state machine model.

Figure 9-3 Cluster communications with replicated state machine

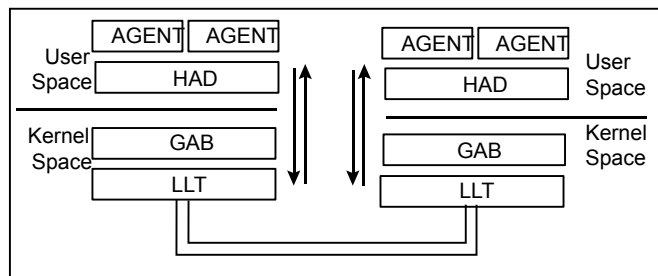

About Group Membership Services/Atomic Broadcast (GAB)

The Group Membership Services/Atomic Broadcast protocol (GAB) is responsible for cluster membership and reliable cluster communications.

GAB has the following two major functions:

- Cluster membership
 - GAB maintains cluster membership by receiving input on the status of the heartbeat from each system via LLT. When a system no longer receives heartbeats from a cluster peer, LLT passes the heartbeat loss notification to

GAB. GAB marks the peer as DOWN and excludes it from the cluster. In most configurations, membership arbitration is used to prevent network partitions.

- **Cluster communications**
GAB's second function is reliable cluster communications. GAB provides ordered guaranteed delivery of messages to all cluster systems. The Atomic Broadcast functionality is used by HAD to ensure that all systems within the cluster receive all configuration change messages, or are rolled back to the previous state, much like a database atomic commit. While the communications function in GAB is known as Atomic Broadcast, no actual network broadcast traffic is generated. An Atomic Broadcast message is a series of point to point unicast messages from the sending system to each receiving system, with a corresponding acknowledgement from each receiving system.

About Low Latency Transport (LLT)

The Low Latency Transport protocol is used for all cluster communications as a high-performance, low-latency replacement for the IP stack.

LLT has the following two major functions:

- **Traffic distribution**
LLT provides the communications backbone for GAB. LLT distributes (load balances) inter-system communication across all configured network links. This distribution ensures all cluster communications are evenly distributed across all network links for performance and fault resilience. If a link fails, traffic is redirected to the remaining links. A maximum of eight network links are supported.
- **Heartbeat**
LLT is responsible for sending and receiving heartbeat traffic over each configured network link. The heartbeat traffic is point to point unicast. LLT uses ethernet broadcast to learn the address of the nodes in the cluster. All other cluster communications, including all status and configuration traffic is point to point unicast. The heartbeat is used by the Group Membership Services to determine cluster membership.

The heartbeat signal is defined as follows:

- LLT on each system in the cluster sends heartbeat packets out on all configured LLT interfaces every half second.
- LLT on each system tracks the heartbeat status from each peer on each configured LLT interface.
- LLT on each system forwards the heartbeat status of each system in the cluster to the local Group Membership Services function of GAB.

- GAB receives the status of heartbeat from all cluster systems from LLT and makes membership determination based on this information.

Figure 9-4 shows heartbeat in the cluster.

Figure 9-4 Heartbeat in the cluster

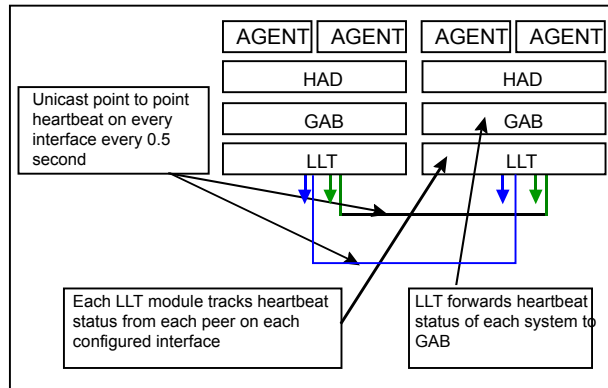

LLT can be configured to designate specific cluster interconnect links as either high priority or low priority. High priority links are used for cluster communications to GAB as well as heartbeat signals. Low priority links, during normal operation, are used for heartbeat and link state maintenance only, and the frequency of heartbeats is reduced to 50% of normal to reduce network overhead.

If there is a failure of all configured high priority links, LLT will switch all cluster communications traffic to the first available low priority link. Communication traffic will revert back to the high priority links as soon as they become available.

While not required, best practice recommends to configure at least one low priority link, and to configure two high priority links on dedicated cluster interconnects to provide redundancy in the communications path. Low priority links are typically configured on the public or administrative network.

If you use different media speed for the private NICs, Veritas recommends that you configure the NICs with lesser speed as low-priority links to enhance LLT performance. With this setting, LLT does active-passive load balancing across the private links. At the time of configuration and failover, LLT automatically chooses the link with high-priority as the active link and uses the low-priority links only when a high-priority link fails.

LLT sends packets on all the configured links in weighted round-robin manner. LLT uses the linkburst parameter which represents the number of back-to-back packets that LLT sends on a link before the next link is chosen. In addition to the default weighted round-robin based load balancing, LLT also provides destination-based load balancing. LLT implements destination-based load balancing where the LLT

link is chosen based on the destination node id and the port. With destination-based load balancing, LLT sends all the packets of a particular destination on a link. However, a potential problem with the destination-based load balancing approach is that LLT may not fully utilize the available links if the ports have dissimilar traffic. Veritas recommends destination-based load balancing when the setup has more than two cluster nodes and more active LLT ports. You must manually configure destination-based load balancing for your cluster to set up the port to LLT link mapping.

See [“Configuring destination-based load balancing for LLT”](#) on page 186.

LLT on startup sends broadcast packets with LLT node id and cluster id information onto the LAN to discover any node in the network that has same node id and cluster id pair. Each node in the network replies to this broadcast message with its cluster id, node id, and node name.

LLT on the original node does not start and gives appropriate error in the following cases:

- LLT on any other node in the same network is running with the same node id and cluster id pair that it owns.
- LLT on the original node receives response from a node that does not have a node name entry in the `/etc/llthosts` file.

About cluster membership

The current members of the cluster are the systems that are actively participating in the cluster. It is critical for Cluster Server engine (HAD) to accurately determine current cluster membership in order to take corrective action on system failure and maintain overall cluster topology.

A change in cluster membership is one of the starting points of the logic to determine if HAD needs to perform any fault handling in the cluster.

There are two aspects to cluster membership, initial joining of the cluster and how membership is determined once the cluster is up and running.

Initial joining of systems to cluster membership

When the cluster initially boots, LLT determines which systems are sending heartbeat signals, and passes that information to GAB. GAB uses this information in the process of seeding the cluster membership.

Seeding a new cluster

Seeding ensures a new cluster will start with an accurate membership count of the number of systems in the cluster. This prevents the possibility of one cluster splitting into multiple subclusters upon initial startup.

A new cluster can be automatically seeded as follows:

- When the cluster initially boots, all systems in the cluster are unseeded.
- GAB checks the number of systems that have been declared to be members of the cluster in the `/etc/gabtab` file.

The number of systems declared in the cluster is denoted as follows:

```
/sbin/gabconfig -c -nN
```

where the variable `#` is replaced with the number of systems in the cluster.

Note: Veritas recommends that you replace `#` with the exact number of nodes in the cluster.

- When GAB on each system detects that the correct number of systems are running, based on the number declared in `/etc/gabtab` and input from LLT, it will seed.
- If you have I/O fencing enabled in your cluster and if you have set the GAB auto-seeding feature through I/O fencing, GAB automatically seeds the cluster even when some cluster nodes are unavailable.
See [“Seeding a cluster using the GAB auto-seed parameter through I/O fencing”](#) on page 314.
- HAD will start on each seeded system. HAD will only run on a system that has seeded.
HAD can provide the HA functionality only when GAB has seeded.

See [“Manual seeding of a cluster”](#) on page 315.

Seeding a cluster using the GAB auto-seed parameter through I/O fencing

If some of the nodes are not up and running in a cluster, then GAB port does not come up to avoid any risks of preexisting split-brain. In such cases, you can manually seed GAB using the command `gabconfig -x` to bring the GAB port up.

See [“Manual seeding of a cluster”](#) on page 315.

However, if you have enabled I/O fencing in the cluster, then I/O fencing can handle any preexisting split-brain in the cluster. You can configure I/O fencing in such a way for GAB to automatically seed the cluster. The behavior is as follows:

- If a number of nodes in a cluster are not up, GAB port (port a) still comes up in all the member-nodes in the cluster.
- If the coordination points do not have keys from any non-member nodes, I/O fencing (GAB port b) also comes up.

This feature is disabled by default. You must configure the `autoseed_gab_timeout` parameter in the `/etc/vxfenmode` file to enable the automatic seeding feature of GAB.

See [“About I/O fencing configuration files”](#) on page 338.

To enable GAB auto-seeding parameter of I/O fencing

- ◆ Set the value of the `autoseed_gab_timeout` parameter in the `/etc/vxfenmode` file to 0 to turn on the feature.

To delay the GAB auto-seed feature, you can also set a value greater than zero. GAB uses this value to delay auto-seed of the cluster for the given number of seconds.

To disable GAB auto-seeding parameter of I/O fencing

- ◆ Set the value of the `autoseed_gab_timeout` parameter in the `/etc/vxfenmode` file to -1 to turn off the feature.

You can also remove the line from the `/etc/vxfenmode` file.

Manual seeding of a cluster

Seeding the cluster manually is appropriate when the number of cluster systems declared in `/etc/gabtab` is more than the number of systems that will join the cluster.

This can occur if a system is down for maintenance when the cluster comes up.

Warning: It is not recommended to seed the cluster manually unless the administrator is aware of the risks and implications of the command.

Note:

If you have I/O fencing enabled in your cluster, you can set the GAB auto-seeding feature through I/O fencing so that GAB automatically seeds the cluster even when some cluster nodes are unavailable.

See [“Seeding a cluster using the GAB auto-seed parameter through I/O fencing”](#) on page 314.

Before manually seeding the cluster, check that systems that will join the cluster are able to send and receive heartbeats to each other. Confirm there is no possibility of a network partition condition in the cluster.

Before manually seeding the cluster, do the following:

- Check that systems that will join the cluster are able to send and receive heartbeats to each other.
- Confirm there is no possibility of a network partition condition in the cluster.

To manually seed the cluster, type the following command:

```
/sbin/gabconfig -x
```

Note there is no declaration of the number of systems in the cluster with a manual seed. This command will seed all systems in communication with the system where the command is run.

So, make sure not to run this command in more than one node in the cluster.

See [“Seeding and I/O fencing”](#) on page 703.

Ongoing cluster membership

Once the cluster is up and running, a system remains an active member of the cluster as long as peer systems receive a heartbeat signal from that system over the cluster interconnect. A change in cluster membership is determined as follows:

- When LLT on a system no longer receives heartbeat messages from a system on any of the configured LLT interfaces for a predefined time (peerinact), LLT informs GAB of the heartbeat loss from that specific system.
This predefined time is 32 seconds by default, but can be configured.
You can set this predefined time with the `set-timer peerinact` command.
See the `llttab` manual page.
- When LLT informs GAB of a heartbeat loss, the systems that are remaining in the cluster coordinate to agree which systems are still actively participating in the cluster and which are not. This happens during a time period known as GAB Stable Timeout (5 seconds).

VCS has specific error handling that takes effect in the case where the systems do not agree.

- GAB marks the system as DOWN, excludes the system from the cluster membership, and delivers the membership change to the fencing module.
- The fencing module performs membership arbitration to ensure that there is not a split brain situation and only one functional cohesive cluster continues to run.

The fencing module is turned on by default.

Review the details on actions that occur if the fencing module has been deactivated:

See [“About cluster membership and data protection without I/O fencing”](#) on page 349.

About membership arbitration

Membership arbitration is necessary on a perceived membership change because systems may falsely appear to be down. When LLT on a system no longer receives heartbeat messages from another system on any configured LLT interface, GAB marks the system as DOWN. However, if the cluster interconnect network failed, a system can appear to be failed when it actually is not. In most environments when this happens, it is caused by an insufficient cluster interconnect network infrastructure, usually one that routes all communication links through a single point of failure.

If all the cluster interconnect links fail, it is possible for one cluster to separate into two subclusters, each of which does not know about the other subcluster. The two subclusters could each carry out recovery actions for the departed systems. This condition is termed split brain.

In a split brain condition, two systems could try to import the same storage and cause data corruption, have an IP address up in two places, or mistakenly run an application in two places at once.

Membership arbitration guarantees against such split brain conditions.

About membership arbitration components

The components of membership arbitration are the fencing module and the coordination points.

See [“About the fencing module”](#) on page 318.

See [“About coordination points”](#) on page 318.

About the fencing module

Each system in the cluster runs a kernel module called vxfen, or the fencing module. This module is responsible for ensuring valid and current cluster membership during a membership change through the process of membership arbitration.

vxfen performs the following actions:

- Registers with the coordination points during normal operation
- Races for control of the coordination points during membership changes

About coordination points

Coordination points provide a lock mechanism to determine which nodes get to fence off data drives from other nodes. A node must eject a peer from the coordination points before it can fence the peer from the data drives. VCS prevents split-brain when vxfen races for control of the coordination points and the winner partition fences the ejected nodes from accessing the data disks.

Note: Typically, a fencing configuration for a cluster must have three coordination points. Veritas Technologies also supports server-based fencing with a single CP server as its only coordination point with a caveat that this CP server becomes a single point of failure.

The coordination points can either be disks or servers or both.

- Coordinator disks

Disks that act as coordination points are called coordinator disks. Coordinator disks are three standard disks or LUNs set aside for I/O fencing during cluster reconfiguration. Coordinator disks do not serve any other storage purpose in the VCS configuration.

You can configure coordinator disks to use Veritas Volume Manager's Dynamic Multi-pathing (DMP) feature. Dynamic Multi-pathing (DMP) allows coordinator disks to take advantage of the path failover and the dynamic adding and removal capabilities of DMP. So, you can configure I/O fencing to use DMP devices. I/O fencing uses SCSI-3 disk policy that is dmp-based on the disk device that you use.

Note: The dmp disk policy for I/O fencing supports both single and multiple hardware paths from a node to the coordinator disks. If few coordinator disks have multiple hardware paths and few have a single hardware path, then we support only the dmp disk policy. For new installations, Veritas Technologies only supports dmp disk policy for IO fencing even for a single hardware path.

See the *Storage Foundation Administrator's Guide*.

- Coordination point servers

The coordination point server (CP server) is a software solution which runs on a remote system or cluster. CP server provides arbitration functionality by allowing the SFHA cluster nodes to perform the following tasks:

- Self-register to become a member of an active VCS cluster (registered with CP server) with access to the data drives
- Check which other nodes are registered as members of this active VCS cluster
- Self-unregister from this active VCS cluster
- Forcefully unregister other nodes (preempt) as members of this active VCS cluster

In short, the CP server functions as another arbitration mechanism that integrates within the existing I/O fencing module.

Note: With the CP server, the fencing arbitration logic still remains on the VCS cluster.

Multiple VCS clusters running different operating systems can simultaneously access the CP server. TCP/IP based communication is used between the CP server and the VCS clusters.

About preferred fencing

The I/O fencing driver uses coordination points to prevent split-brain in a VCS cluster. By default, the fencing driver favors the subcluster with maximum number of nodes during the race for coordination points. With the preferred fencing feature, you can specify how the fencing driver must determine the surviving subcluster.

You can configure the preferred fencing policy using the cluster-level attribute PreferredFencingPolicy for the following:

- Enable system-based preferred fencing policy to give preference to high capacity systems.
- Enable group-based preferred fencing policy to give preference to service groups for high priority applications.
- Enable site-based preferred fencing policy to give preference to sites with higher priority.
- Disable preferred fencing policy to use the default node count-based race policy.

See [“How preferred fencing works”](#) on page 323.

See [“Enabling or disabling the preferred fencing policy”](#) on page 415.

How the fencing module starts up

The fencing module starts up as follows:

- The coordinator disks are placed in a disk group.
This allows the fencing startup script to use Veritas Volume Manager (VxVM) commands to easily determine which disks are coordinator disks, and what paths exist to those disks. This disk group is never imported, and is not used for any other purpose.
- The fencing start up script on each system uses VxVM commands to populate the file `/etc/vxfentab` with the paths available to the coordinator disks.
See [“About I/O fencing configuration files”](#) on page 338.
- When the fencing driver is started, it reads the physical disk names from the `/etc/vxfentab` file. Using these physical disk names, it determines the serial numbers of the coordinator disks and builds an in-memory list of the drives.
- The fencing driver verifies that the systems that are already running in the cluster see the same coordinator disks.
The fencing driver examines GAB port B for membership information. If no other system is up and running, it is the first system up and is considered to have the correct coordinator disk configuration. When a new member joins, it requests the coordinator disks configuration. The system with the lowest LLT ID will respond with a list of the coordinator disk serial numbers. If there is a match, the new member joins the cluster. If there is not a match, `vxfen` enters an error state and the new member is not allowed to join. This process ensures all systems communicate with the same coordinator disks.
- The fencing driver determines if a possible preexisting split brain condition exists. This is done by verifying that any system that has keys on the coordinator disks can also be seen in the current GAB membership. If this verification fails, the fencing driver prints a warning to the console and system log and does not start.
- If all verifications pass, the fencing driver on each system registers keys with each coordinator disk.

Figure 9-5 Topology of coordinator disks in the cluster

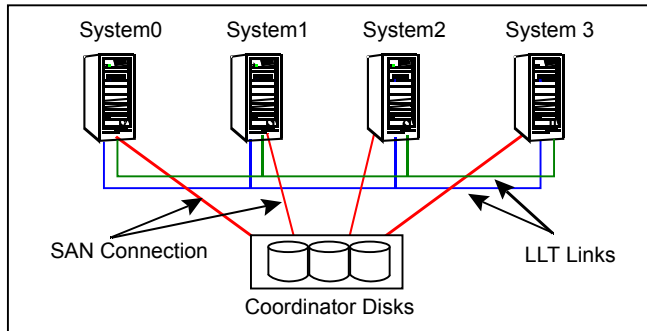

How membership arbitration works

Upon startup of the cluster, all systems register a unique key on the coordinator disks. The key is unique to the cluster and the node, and is based on the LLT cluster ID and the LLT system ID.

See [“About the I/O fencing registration key format”](#) on page 368.

When there is a perceived change in membership, membership arbitration works as follows:

- GAB marks the system as DOWN, excludes the system from the cluster membership, and delivers the membership change—the list of departed systems—to the fencing module.
- The system with the lowest LLT system ID in the cluster races for control of the coordinator disks
 - In the most common case, where departed systems are truly down or faulted, this race has only one contestant.
 - In a split brain scenario, where two or more subclusters have formed, the race for the coordinator disks is performed by the system with the lowest LLT system ID of that subcluster. This system that races on behalf of all the other systems in its subcluster is called the RACER node and the other systems in the subcluster are called the SPECTATOR nodes.
- During the I/O fencing race, if the RACER node panics or if it cannot reach the coordination points, then the VxFEN RACER node re-election feature allows an alternate node in the subcluster that has the next lowest node ID to take over as the RACER node.

The racer re-election works as follows:

- In the event of an unexpected panic of the RACER node, the VxFEN driver initiates a racer re-election.
- If the RACER node is unable to reach a majority of coordination points, then the VxFEN module sends a RELAY_RACE message to the other nodes in the subcluster. The VxFEN module then re-elects the next lowest node ID as the new RACER.
- With successive re-elections if no more nodes are available to be re-elected as the RACER node, then all the nodes in the subcluster will panic.
- The race consists of executing a preempt and abort command for each key of each system that appears to no longer be in the GAB membership. The preempt and abort command allows only a registered system with a valid key to eject the key of another system. This ensures that even when multiple systems attempt to eject other, each race will have only one winner. The first system to issue a preempt and abort command will win and eject the key of the other system. When the second system issues a preempt and abort command, it cannot perform the key eject because it is no longer a registered system with a valid key.
 If the value of the cluster-level attribute PreferredFencingPolicy is System, Group, or Site then at the time of a race, the VxFEN Racer node adds up the weights for all nodes in the local subcluster and in the leaving subcluster. If the leaving partition has a higher sum (of node weights) then the racer for this partition will delay the race for the coordination point. This effectively gives a preference to the more critical subcluster to win the race. If the value of the cluster-level attribute PreferredFencingPolicy is Disabled, then the delay will be calculated, based on the sums of node counts.
 See [“About preferred fencing”](#) on page 319.
- If the preempt and abort command returns success, that system has won the race for that coordinator disk.
 Each system will repeat this race to all the coordinator disks. The race is won by, and control is attained by, the system that ejects the other system’s registration keys from a majority of the coordinator disks.
- On the system that wins the race, the vxfen module informs all the systems that it was racing on behalf of that it won the race, and that subcluster is still valid.
- On the system(s) that do not win the race, the vxfen module will trigger a system panic. The other systems in this subcluster will note the panic, determine they lost control of the coordinator disks, and also panic and restart.
- Upon restart, the systems will attempt to seed into the cluster.
 - If the systems that restart can exchange heartbeat with the number of cluster systems declared in /etc/gabtab, they will automatically seed and continue

to join the cluster. Their keys will be replaced on the coordinator disks. This case will only happen if the original reason for the membership change has cleared during the restart.

- If the systems that restart cannot exchange heartbeat with the number of cluster systems declared in `/etc/gabtab`, they will not automatically seed, and HAD will not start. This is a possible split brain condition, and requires administrative intervention.
- If you have I/O fencing enabled in your cluster and if you have set the GAB auto-seeding feature through I/O fencing, GAB automatically seeds the cluster even when some cluster nodes are unavailable.
See [“Seeding a cluster using the GAB auto-seed parameter through I/O fencing”](#) on page 314.

Note: Forcing a manual seed at this point will allow the cluster to seed. However, when the fencing module checks the GAB membership against the systems that have keys on the coordinator disks, a mismatch will occur. `vxfen` will detect a possible split brain condition, print a warning, and will not start. In turn, HAD will not start. Administrative intervention is required.

See [“Manual seeding of a cluster”](#) on page 315.

How preferred fencing works

The I/O fencing driver uses coordination points to prevent split-brain in a VCS cluster. At the time of a network partition, the fencing driver in each subcluster races for the coordination points. The subcluster that grabs the majority of coordination points survives whereas the fencing driver causes a system panic on nodes from all other subclusters. By default, the fencing driver favors the subcluster with maximum number of nodes during the race for coordination points.

This default racing preference does not take into account the application groups that are online on any nodes or the system capacity in any subcluster. For example, consider a two-node cluster where you configured an application on one node and the other node is a standby-node. If there is a network partition and the standby-node wins the race, the node where the application runs panics and VCS has to bring the application online on the standby-node. This behavior causes disruption and takes time for the application to fail over to the surviving node and then to start up again.

The preferred fencing feature lets you specify how the fencing driver must determine the surviving subcluster. The preferred fencing solution makes use of a fencing parameter called node weight. VCS calculates the node weight based on online

applications, system capacity, and site preference details that you provide using specific VCS attributes, and passes to the fencing driver to influence the result of race for coordination points. At the time of a race, the racer node adds up the weights for all nodes in the local subcluster and in the leaving subcluster. If the leaving subcluster has a higher sum (of node weights) then the racer for this subcluster delays the race for the coordination points. Thus, the subcluster that has critical systems or critical applications wins the race.

The preferred fencing feature uses the cluster-level attribute PreferredFencingPolicy that takes the following race policy values:

- **Disabled (default):** Preferred fencing is disabled.
When the PreferredFencingPolicy attribute value is set as Disabled, VCS sets the count based race policy and resets the value of node weight as 0.
- **System:** Based on the capacity of the systems in a subcluster.
If one system is more powerful than others in terms of architecture, number of CPUs, or memory, this system is given preference in the fencing race.
When the PreferredFencingPolicy attribute value is set as System, VCS calculates node weight based on the system-level attribute FencingWeight. See [System attributes](#) on page 816.
- **Group:** Based on the higher priority applications in a subcluster.
The fencing driver takes into account the service groups that are online on the nodes in any subcluster.
In the event of a network partition, I/O fencing determines whether the VCS engine is running on all the nodes that participate in the race for coordination points. If VCS engine is running on all the nodes, the node with higher priority service groups is given preference during the fencing race.
However, if the VCS engine instance on a node with higher priority service groups is killed for some reason, I/O fencing resets the preferred fencing node weight for that node to zero. I/O fencing does not prefer that node for membership arbitration. Instead, I/O fencing prefers a node that has an instance of VCS engine running on it even if the node has lesser priority service groups.
Without synchronization between VCS engine and I/O fencing, a node with high priority service groups but without VCS engine running on it may win the race. Such a situation means that the service groups on the loser node cannot failover to the surviving node.
When the PreferredFencingPolicy attribute value is set as Group, VCS calculates node weight based on the group-level attribute Priority for those service groups that are active.
See [“Service group attributes”](#) on page 789.
- **Site:** Based on the priority assigned to sites in a subcluster.

The Site policy is available only if you set the cluster attribute SiteAware to 1. VCS sets higher weights to the nodes in a higher priority site and lesser weights to the nodes in a lower priority site. The site with highest cumulative node weight becomes the preferred site. In a network partition between sites, VCS prefers the subcluster with nodes from the preferred site in the race for coordination points.

See [“Site attributes”](#) on page 851.

See [“Enabling or disabling the preferred fencing policy”](#) on page 415.

About server-based I/O fencing

In a disk-based I/O fencing implementation, the vxfen driver handles various SCSI-3 PR based arbitration operations completely within the driver. I/O fencing also provides a framework referred to as customized fencing wherein arbitration operations are implemented in custom scripts. The vxfen driver invokes the custom scripts.

The CP server-based coordination point uses a customized fencing framework. Note that SCSI-3 PR based fencing arbitration can also be enabled using customized fencing framework. This allows the user to specify a combination of SCSI-3 LUNs and CP servers as coordination points using customized fencing. Customized fencing can be enabled by specifying `vxfen_mode=customized` and `vxfen_mechanism=cps` in the `/etc/vxfenmode` file.

[Figure 9-6](#) displays a schematic of the customized fencing options.

Figure 9-6 Customized fencing

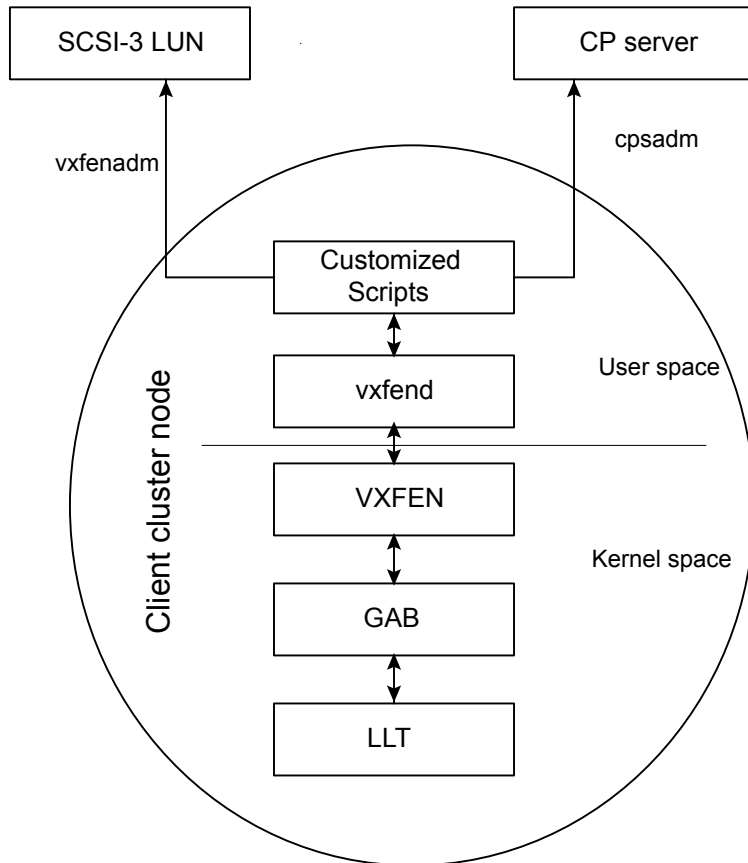

A user level daemon `vxfend` interacts with the `vxfen` driver, which in turn interacts with GAB to get the node membership update. Upon receiving membership updates, `vxfend` invokes various scripts to race for the coordination point and fence off data disks. The `vxfend` daemon manages various fencing agents. The customized fencing scripts are located in the `/opt/VRTSvcs/vxfen/bin/customized/cps` directory.

The scripts that are involved include the following:

- `generate_snapshot.sh` : Retrieves the SCSI ID's of the coordinator disks and/or UUID ID's of the CP servers
 CP server uses the UUID stored in `/etc/VRTSvcs/db/current/cps_uuid`.
 See [“About the cluster UUID”](#) on page 37.
- `join_local_node.sh`: Registers the keys with the coordinator disks or CP servers

- `race_for_coordination_point.sh`: Races to determine a winner after cluster reconfiguration
- `unjoin_local_node.sh`: Removes the keys that are registered in `join_local_node.sh`
- `fence_data_disks.sh`: Fences the data disks from access by the losing nodes.
- `local_info.sh`: Lists local node's configuration parameters and coordination points, which are used by the `vxfs` driver.

I/O fencing enhancements provided by CP server

CP server configurations enhance disk-based I/O fencing by providing the following new capabilities:

- CP server configurations are scalable, and a configuration with three CP servers can provide I/O fencing for multiple VCS clusters. Since a single CP server configuration can serve a large number of VCS clusters, the cost of multiple VCS cluster deployments can be significantly reduced.
- Appropriately situated CP servers can eliminate any coordinator disk location bias in the I/O fencing process. For example, this location bias may occur where, due to logistical restrictions, two of the three coordinator disks are located at a single site, and the cost of setting up a third coordinator disk location is prohibitive.

See [Figure 9-7](#) on page 328.

In such a configuration, if the site with two coordinator disks is inaccessible, the other site does not survive due to a lack of a majority of coordination points. I/O fencing would require extension of the SAN to the third site which may not be a suitable solution. An alternative is to place a CP server at a remote site as the third coordination point.

Note: The CP server provides an alternative arbitration mechanism without having to depend on SCSI-3 compliant coordinator disks. Data disk fencing in Cluster Volume Manager (CVM) will still require SCSI-3 I/O fencing.

Figure 9-7 Skewed placement of coordinator disks at Site 1

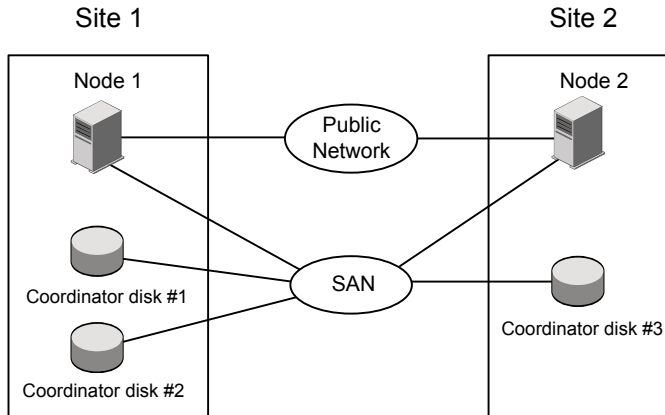

About majority-based fencing

The majority-based fencing mode is a fencing mechanism that does not need coordination points. You do not need shared disks or free nodes to be used as coordination points or servers.

The fencing mechanism provides an arbitration method that is reliable and does not require any extra hardware setup., such as CP Servers or shared SCSI3 disks. In a split brain scenario, arbitration is done based on `majority` number of nodes among the sub-clusters.

Majority-based fencing: If N is defined as the total number of nodes (current membership) in the cluster, then majority is equal to $N/2 + 1$.

Leader node: The node with the lowest node ID in the cluster (before the split brain happened) is called the leader node. This plays a role in case of a tie.

How majority-based I/O fencing works

When a network partition happens, one node in each sub-cluster is elected as the racer node, while the other nodes are designated as spectator nodes. As majority-based fencing does not use coordination points, sub-clusters do not engage in an actual race to decide the winner after a split brain scenario. The sub-cluster with the majority number of nodes survives while nodes in the rest of the sub-clusters are taken offline.

The following algorithm is used to decide the winner sub-cluster:

- 1** The node with the lowest node ID in the current gab membership, before the network partition, is designated as the leader node in the fencing race.
- 2** When a network partition occurs, each racer sub-cluster computes the number of nodes in its partition and compares it with that of the leaving partition.
- 3** If a racer finds that its partition does not have majority, it sends a LOST_RACE message to all the nodes in its partition including itself and all the nodes panic. On the other hand, if the racer finds that it does have majority, it sends a WON_RACE message to all the nodes. Thus, the partition with majority nodes survives.

Deciding cluster majority for majority-based I/O fencing mechanism

Considerations to decide cluster majority in the event of a network partition:

- 1.** Odd number of cluster nodes in the current membership: One sub-cluster gets majority upon a network split.
- 2.** Even number of cluster nodes in the current membership: In case of an even network split, both the sub-clusters have equal number of nodes. The partition with the leader node is treated as majority and that partition survives.

In case of an uneven network split, such that one sub-cluster has more number of nodes than other sub-clusters, the majority sub-cluster gets majority and survives.

About making CP server highly available

If you want to configure a multi-node CP server cluster, install and configure SFHA on the CP server nodes. Otherwise, install and configure VCS on the single node.

In both the configurations, VCS provides local start and stop of the CP server process, taking care of dependencies such as NIC, IP address, and so on. Moreover, VCS also serves to restart the CP server process in case the process faults.

VCS can use multiple network paths to access a CP server. If a network path fails, CP server does not require a restart and continues to listen on one of the other available virtual IP addresses.

To make the CP server process highly available, you must perform the following tasks:

- Install and configure SFHA on the CP server systems.
- Configure the CP server process as a failover service group.

- Configure disk-based I/O fencing to protect the shared CP server database.

Note: Veritas recommends that you do not run any other applications on the single node or SFHA cluster that is used to host CP server.

A single CP server can serve up to 128 VCS clusters. A common set of CP servers can also serve up to 128 VCS clusters.

About the CP server database

CP server requires a database for storing the registration keys of the VCS cluster nodes. CP server uses a SQLite database for its operations. By default, the database is located at `/etc/VRTScps/db`.

For a single node VCS cluster hosting a CP server, the database can be placed on a local file system. For an SFHA cluster hosting a CP server, the database must be placed on a shared file system. The file system must be shared among all nodes that are part of the SFHA cluster.

In an SFHA cluster hosting the CP server, the shared database is protected by setting up SCSI-3 PR based I/O fencing. SCSI-3 PR based I/O fencing protects against split-brain scenarios.

Warning: The CP server database must not be edited directly and should only be accessed using `cpsadm(1M)`. Manipulating the database manually may lead to undesirable results including system panics.

Recommended CP server configurations

Following are the recommended CP server configurations:

- Multiple application clusters use three CP servers as their coordination points
See [Figure 9-8](#) on page 331.
- Multiple application clusters use a single CP server and single or multiple pairs of coordinator disks (two) as their coordination points
See [Figure 9-9](#) on page 332.
- Multiple application clusters use a single CP server as their coordination point
This single coordination point fencing configuration must use a highly available CP server that is configured on an SFHA cluster as its coordination point.
See [Figure 9-10](#) on page 332.

Warning: In a single CP server fencing configuration, arbitration facility is not available during a failover of the CP server in the SFHA cluster. So, if a network partition occurs on any application cluster during the CP server failover, the application cluster is brought down.

Although the recommended CP server configurations use three coordination points, you can use more than three coordination points for I/O fencing. Ensure that the total number of coordination points you use is an odd number. In a configuration where multiple application clusters share a common set of CP server coordination points, the application cluster as well as the CP server use a Universally Unique Identifier (UUID) to uniquely identify an application cluster.

Figure 9-8 displays a configuration using three CP servers that are connected to multiple application clusters.

Figure 9-8 Three CP servers connecting to multiple application clusters

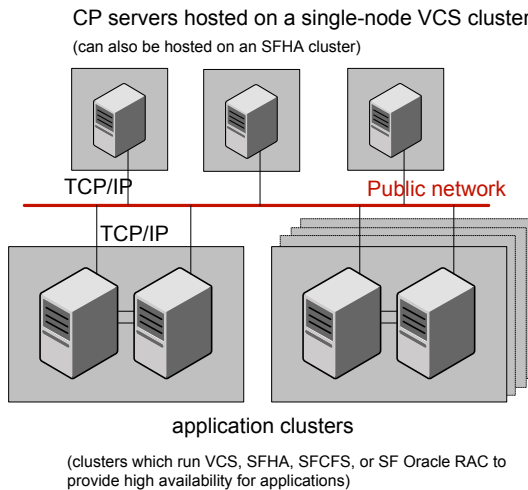

Figure 9-9 displays a configuration using a single CP server that is connected to multiple application clusters with each application cluster also using two coordinator disks.

Figure 9-9 Single CP server with two coordinator disks for each application cluster

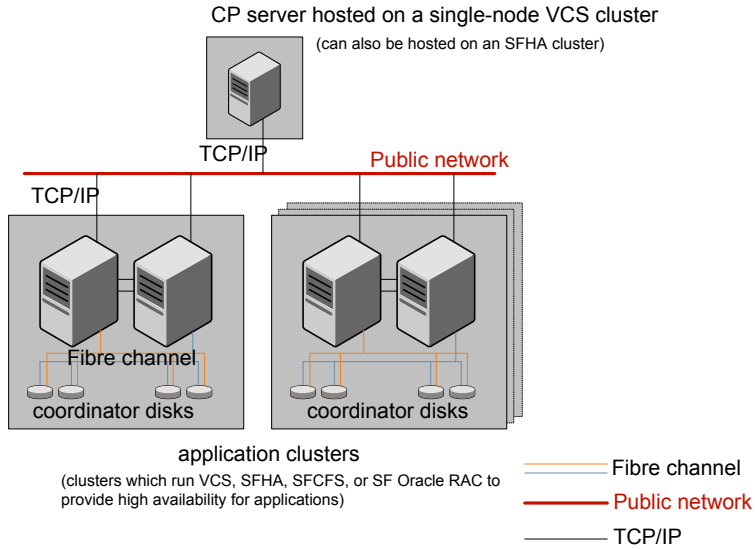
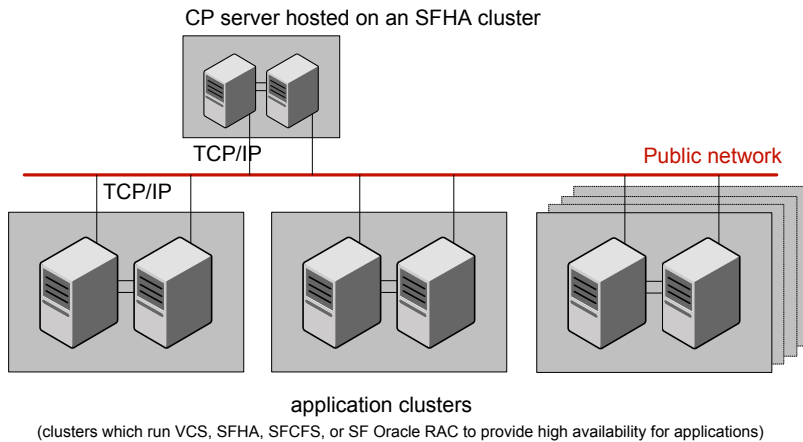

Figure 9-10 displays a configuration using a single CP server that is connected to multiple application clusters.

Figure 9-10 Single CP server connecting to multiple application clusters



About the CP server service group

The CP server service group (CPSSG) is a VCS service group. An I/O fencing configuration using CP server requires the CP server service group.

You can configure the CP server service group failover policies using the Quorum agent. CP server uses the Quorum agent to monitor the virtual IP addresses of the CP server.

See [“About the Quorum agent for CP server”](#) on page 334.

[Figure 9-11](#) displays a schematic of the CPSSG group and its dependencies when CP server is hosted on a single node VCS cluster.

Figure 9-11 CPSSG group when CP server hosted on a single node VCS cluster

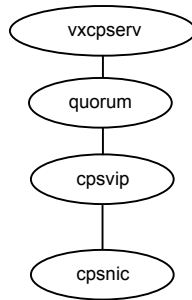

[Figure 9-12](#) displays a schematic of the CPSSG group and its dependencies when the CP server is hosted on an SFHA cluster.

Figure 9-12 CPSSG group when the CP server is hosted on an SFHA cluster

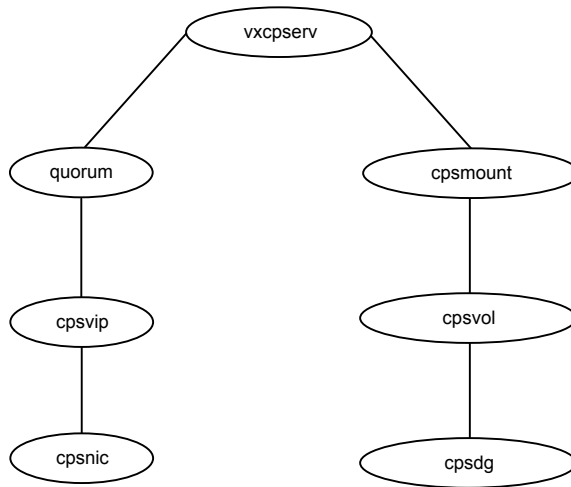

About the Quorum agent for CP server

Coordination point server (CP server) uses the Quorum agent to monitor the virtual IP addresses of the CP server. This agent is installed as part of the VRTScps fileset. The agent's functions include online, monitor, offline, and clean.

You can configure the CP server service group failover policies using the Quorum agent.

The attributes of the Quorum agent are as follows:

- **QuorumResources**
This attribute defines the IP resources that the agent must monitor.
- **Quorum**
The value of the Quorum attribute determines the minimum number of virtual IP addresses that the CP server requires to come up. The default value is 1.
- **State**
This attribute is used to display the log message at info level in the Quorum agent log file when Quorum reaches its threshold value. This attribute is for internal use of VCS and not editable. The log file can be found at, `/var/VRTSvcs/log/Quorum_A.log`.

The resource type definition for the Quorum agent is as follows:

```

type Quorum (
    static str ArgList[] = { QuorumResources, Quorum, State }
    str QuorumResources[]
  )
  
```

```
        int Quorum = 1  
    )
```

About the CP server user types and privileges

The CP server supports the following user types, each with a different access level privilege:

- CP server administrator (admin)
- CP server operator

Different access level privileges permit the user to issue different commands. If a user is neither a CP server admin nor a CP server operator user, then the user has guest status and can issue limited commands.

The user types and their access level privileges are assigned to individual users during VCS cluster configuration for fencing. During the installation process, you are prompted for a user name, password, and access level privilege (CP server admin or CP server operator).

To administer and operate a CP server, there must be at least one CP server admin.

A root user on a CP server is given all the administrator privileges, and these administrator privileges can be used to perform all the CP server specific operations.

About secure communication between the VCS cluster and CP server

In a data center, TCP/IP communication between the VCS cluster (application cluster) and CP server must be made secure. The security of the communication channel involves encryption, authentication, and authorization.

The CP server node or cluster needs to confirm the authenticity of the VCS cluster nodes that communicate with it as a coordination point and only accept requests from known VCS cluster nodes. Requests from unknown clients are rejected as non-authenticated. Similarly, the fencing framework in VCS cluster must confirm that authentic users are conducting fencing operations with the CP server.

The secure mode of communication between CP server and VCS cluster is HTTPS communication.

HTTPS communication: The SSL infrastructure uses the client cluster certificates and CP server certificates to ensure that communication is secure. The HTTPS mode does not use the broker mechanism to create the authentication server credentials.

How secure communication works between the CP servers and the VCS clusters using the HTTPS protocol

HTTPS is HTTP communication over SSL/TLS (Secure Sockets Layer/Transport Layer Security). In HTTPS, the communication between client and server is secure using the Public Key Infrastructure (PKI). HTTPS is an industry standard protocol, which is widely used over the Internet for secure communication. Data encrypted using private key of an entity, can only be decrypted by using its public key. A common trusted entity, such as, the Certification Authority (CA) confirms the identities of the client and server by signing their certificates. In a CP server deployment, both the server and the clients have their own private keys, individual certificates signed by the common CA, and CA's certificate. CP server uses the SSL implementation from OpenSSL to implement HTTPS for secure communication.

CP server and VCS cluster (application cluster) node communication involve the following entities:

- vxcpserv for the CP server
- cpsadm for the VCS cluster node

Communication flow between CP server and VCS cluster nodes with security configured on them is as follows:

- Initial setup:
Identities of CP server and VCS cluster nodes are configured on respective nodes by the VCS installer.

Note: For secure communication using HTTPS, you do not need to establish trust between the CP server and the application cluster.

The signed client certificate is used to establish the identity of the client. Once the CP server authenticates the client, the client can issue the operational commands that are limited to its own cluster.

- Getting credentials from authentication broker:
The `cpsadm` command tries to get the existing credentials that are present on the local node. The installer generates these credentials during fencing configuration.
The `vxcpserv` process tries to get the existing credentials that are present on the local node. The installer generates these credentials when it enables security.
- Communication between CP server and VCS cluster nodes:
After the CP server establishes its credential and is up, it becomes ready to receive data from the clients. After the `cpsadm` command obtains its credentials and authenticates CP server credentials, `cpsadm` connects to the CP server. Data is passed over to the CP server.

- **Validation:**
On receiving data from a particular VCS cluster node, vxcpsserv validates its credentials. If validation fails, then the connection request data is rejected.

About data protection

Membership arbitration by itself is inadequate for complete data protection because it assumes that all systems will either participate in the arbitration or are already down.

Rare situations can arise which must also be protected against. Some examples are:

- A system hang causes the kernel to stop processing for a period of time.
- The system resources were so busy that the heartbeat signal was not sent.
- A break and resume function is supported by the hardware and executed. Dropping the system to a system controller level with a break command can result in the heartbeat signal timeout.

In these types of situations, the systems are not actually down, and may return to the cluster after cluster membership has been recalculated. This could result in data corruption as a system could potentially write to disk before it determines it should no longer be in the cluster.

Combining membership arbitration with data protection of the shared storage eliminates all of the above possibilities for data corruption.

Data protection fences off (removes access to) the shared data storage from any system that is not a current and verified member of the cluster. Access is blocked by the use of SCSI-3 persistent reservations.

About SCSI-3 Persistent Reservation

SCSI-3 Persistent Reservation (SCSI-3 PR) supports device access from multiple systems, or from multiple paths from a single system. At the same time it blocks access to the device from other systems, or other paths.

VCS logic determines when to online a service group on a particular system. If the service group contains a disk group, the disk group is imported as part of the service group being brought online. When using SCSI-3 PR, importing the disk group puts registration and reservation on the data disks. Only the system that has imported the storage with SCSI-3 reservation can write to the shared storage. This prevents a system that did not participate in membership arbitration from corrupting the shared storage.

SCSI-3 PR ensures persistent reservations across SCSI bus resets.

Note: Use of SCSI 3 PR protects against all elements in the IT environment that might be trying to write illegally to storage, not only VCS related elements.

Membership arbitration combined with data protection is termed I/O fencing.

About I/O fencing configuration files

[Table 9-1](#) lists the I/O fencing configuration files.

Table 9-1 I/O fencing configuration files

File	Description
/etc/default/vxfen	<p>This file stores the start and stop environment variables for I/O fencing:</p> <ul style="list-style-type: none"> ■ VXFEN_START—Defines the startup behavior for the I/O fencing module after a system reboot. Valid values include: <ul style="list-style-type: none"> 1—Indicates that I/O fencing is enabled to start up. 0—Indicates that I/O fencing is disabled to start up. ■ VXFEN_STOP—Defines the shutdown behavior for the I/O fencing module during a system shutdown. Valid values include: <ul style="list-style-type: none"> 1—Indicates that I/O fencing is enabled to shut down. 0—Indicates that I/O fencing is disabled to shut down. <p>The installer sets the value of these variables to 1 at the end of VCS configuration.</p> <p>If you manually configured VCS, you must make sure to set the values of these environment variables to 1.</p>
/etc/vxfendg	<p>This file includes the coordinator disk group information.</p> <p>This file is not applicable for server-based fencing and majority-based fencing.</p>

Table 9-1 I/O fencing configuration files (*continued*)

File	Description
/etc/vxfenmode	<p>This file contains the following parameters:</p> <ul style="list-style-type: none"> ■ vxfen_mode <ul style="list-style-type: none"> ■ scsi3—For disk-based fencing. ■ customized—For server-based fencing. ■ disabled—To run the I/O fencing driver but not do any fencing operations. ■ majority— For fencing without the use of coordination points. ■ vxfen_mechanism <p>This parameter is applicable only for server-based fencing. Set the value as cps.</p> ■ scsi3_disk_policy <ul style="list-style-type: none"> ■ dmp—Configure the vxfen module to use DMP devices The disk policy is dmp by default. If you use iSCSI devices, you must set the disk policy as dmp. <p>Note: You must use the same SCSI-3 disk policy on all the nodes.</p> ■ List of coordination points <p>This list is required only for server-based fencing configuration.</p> <p>Coordination points in server-based fencing can include coordinator disks, CP servers, or both. If you use coordinator disks, you must create a coordinator disk group containing the individual coordinator disks.</p> <p>Refer to the sample file /etc/vxfen.d/vxfenmode_cps for more information on how to specify the coordination points and multiple IP addresses for each CP server.</p> ■ single_cp <p>This parameter is applicable for server-based fencing which uses a single highly available CP server as its coordination point. Also applicable for when you use a coordinator disk group with single disk.</p> ■ autoseed_gab_timeout <p>This parameter enables GAB automatic seeding of the cluster even when some cluster nodes are unavailable.</p> <p>This feature is applicable for I/O fencing in SCSI3 and customized mode.</p> <p>0—Turns the GAB auto-seed feature on. Any value greater than 0 indicates the number of seconds that GAB must delay before it automatically seeds the cluster.</p> <p>-1—Turns the GAB auto-seed feature off. This setting is the default.</p>

Table 9-1 I/O fencing configuration files (*continued*)

File	Description
/etc/vxfentab	<p>When I/O fencing starts, the vxfen startup script creates this /etc/vxfentab file on each node. The startup script uses the contents of the /etc/vxfendg and /etc/vxfenmode files. Any time a system is rebooted, the fencing driver reinitializes the vxfentab file with the current list of all the coordinator points.</p> <p>Note: The /etc/vxfentab file is a generated file; do not modify this file.</p> <p>For disk-based I/O fencing, the /etc/vxfentab file on each node contains a list of all paths to each coordinator disk along with its unique disk identifier. A space separates the path and the unique disk identifier. An example of the /etc/vxfentab file in a disk-based fencing configuration on one node resembles as follows:</p> <ul style="list-style-type: none"> ■ DMP disk: <pre data-bbox="364 743 1174 913"> /dev/vx/rmdp/rhdisk75 HITACHI%5F1724-100%20%20FASTT%5FDISKS%5F6 00A0B8000215A5D000006804E795D075 /dev/vx/rmdp/rhdisk76 HITACHI%5F1724-100%20%20FASTT%5FDISKS%5F6 00A0B8000215A5D000006814E795D076 /dev/vx/rmdp/rhdisk77 HITACHI%5F1724-100%20%20FASTT%5FDISKS%5F6 00A0B8000215A5D000006824E795D077 </pre> <p>For server-based fencing, the /etc/vxfentab file also includes the security settings information.</p> <p>For server-based fencing with single CP server, the /etc/vxfentab file also includes the single_cp settings information.</p> <p>This file is not applicable for majority-based fencing.</p>

Examples of VCS operation with I/O fencing

This topic describes the general logic employed by the I/O fencing module along with some specific example scenarios. Note that this topic does not apply to majority-based I/O fencing.

See [“About the I/O fencing algorithm”](#) on page 341.

See [“Example: Two-system cluster where one system fails”](#) on page 341.

See [“Example: Four-system cluster where cluster interconnect fails”](#) on page 342.

About the I/O fencing algorithm

To ensure the most appropriate behavior is followed in both common and rare corner case events, the fencing algorithm works as follows:

- The fencing module is designed to never have systems in more than one subcluster remain current and valid members of the cluster. In all cases, either one subcluster will survive, or in very rare cases, no systems will.
- The system with the lowest LLT ID in any subcluster of the original cluster races for control of the coordinator disks on behalf of the other systems in that subcluster.
- If a system wins the race for the first coordinator disk, that system is given priority to win the race for the other coordinator disks.
Any system that loses a race will delay a short period of time before racing for the next disk. Under normal circumstances, the winner of the race to the first coordinator disk will win all disks.
This ensures a clear winner when multiple systems race for the coordinator disk, preventing the case where three or more systems each win the race for one coordinator disk.
- If the cluster splits such that one of the subclusters has at least 51% of the members of the previous stable membership, that subcluster is given priority to win the race.
The system in the smaller subcluster(s) delay a short period before beginning the race.
If you use the preferred fencing feature, then the subcluster with the lesser total weight will delay.
See [“About preferred fencing”](#) on page 319.
This ensures that as many systems as possible will remain running in the cluster.
- If the vxfen module discovers on startup that the system that has control of the coordinator disks is not in the current GAB membership, an error message indicating a possible split brain condition is printed to the console.
The administrator must clear this condition manually with the `vxfenclearpre` utility.

Example: Two-system cluster where one system fails

In this example, System1 fails, and System0 carries out the I/O fencing operation as follows:

- The GAB module on System0 determines System1 has failed due to loss of heartbeat signal reported from LLT.

- GAB passes the membership change to the fencing module on each system in the cluster.
The only system that is still running is System0
- System0 gains control of the coordinator disks by ejecting the key registered by System1 from each coordinator disk.
The ejection takes place one by one, in the order of the coordinator disk's serial number.
- When the fencing module on System0 successfully controls the coordinator disks, HAD carries out any associated policy connected with the membership change.
- System1 is blocked access to the shared storage, if this shared storage was configured in a service group that was now taken over by System0 and imported.

Figure 9-13 I/O Fencing example with system failure

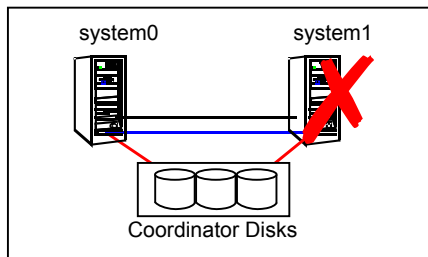

Example: Four-system cluster where cluster interconnect fails

In this example, the cluster interconnect fails in such a way as to split the cluster from one four-system cluster to two-system clusters. The cluster performs membership arbitration to ensure that only one subcluster remains.

Due to loss of heartbeat, System0 and System1 both believe System2 and System3 are down. System2 and System3 both believe System0 and System1 are down.

Figure 9-14 Four-system cluster where cluster interconnect fails

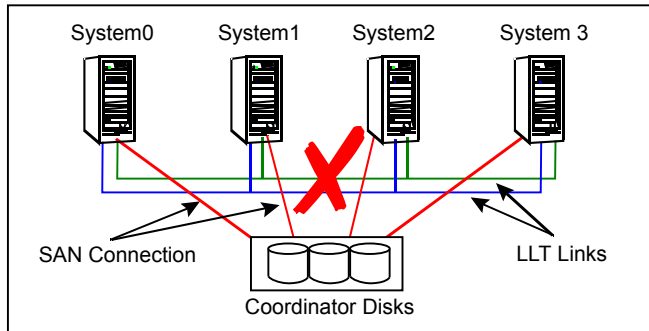

The progression of I/O fencing operations are as follows:

- LLT on each of the four systems no longer receives heartbeat messages from the systems on the other side of the interconnect failure on any of the configured LLT interfaces for the peer inactive timeout configured time.
- LLT on each system passes to GAB that it has noticed a membership change. Specifically:
 - LLT on System0 passes to GAB that it no longer sees System2 and System3
 - LLT on System1 passes to GAB that it no longer sees System2 and System3
 - LLT on System2 passes to GAB that it no longer sees System0 and System1
 - LLT on System3 passes to GAB that it no longer sees System0 and System1
- After LLT informs GAB of a heartbeat loss, the systems that are remaining do a "GAB Stable Timeout" (5 seconds). In this example:
 - System0 and System1 agree that both of them do not see System2 and System3
 - System2 and System3 agree that both of them do not see System0 and System1
- GAB marks the system as DOWN, and excludes the system from the cluster membership. In this example:
 - GAB on System0 and System1 mark System2 and System3 as DOWN and excludes them from cluster membership.
 - GAB on System2 and System3 mark System0 and System1 as DOWN and excludes them from cluster membership.

- GAB on each of the four systems passes the membership change to the vxfen driver for membership arbitration. Each subcluster races for control of the coordinator disks. In this example:
 - System0 has the lower LLT ID, and races on behalf of itself and System1.
 - System2 has the lower LLT ID, and races on behalf of itself and System3.
- GAB on each of the four systems also passes the membership change to HAD. HAD waits for the result of the membership arbitration from the fencing module before taking any further action.
- If System0 is not able to reach a majority of the coordination points, then the VxFEN driver will initiate a racer re-election from System0 to System1 and System1 will initiate the race for the coordination points.
- Assume System0 wins the race for the coordinator disks, and ejects the registration keys of System2 and System3 off the disks. The result is as follows:
 - System0 wins the race for the coordinator disk. The fencing module on System0 sends a WON_RACE to all other fencing modules in the current cluster, in this case System0 and System1. On receiving a WON_RACE, the fencing module on each system in turn communicates success to HAD. System0 and System1 remain valid and current members of the cluster.
 - If System0 dies before it sends a WON_RACE to System1, then VxFEN will initiate a racer re-election from System0 to System1 and System1 will initiate the race for the coordination points. System1 on winning a majority of the coordination points remains valid and current member of the cluster and the fencing module on System1 in turn communicates success to HAD.
 - System2 loses the race for control of the coordinator disks and the fencing module on System 2 sends a LOST_RACE message. The fencing module on System2 calls a kernel panic and the system restarts.
 - System3 sees another membership change from the kernel panic of System2. Because that was the system that was racing for control of the coordinator disks in this subcluster, System3 also panics.
- HAD carries out any associated policy or recovery actions based on the membership change.
- System2 and System3 are blocked access to the shared storage (if the shared storage was part of a service group that is now taken over by System0 or System 1).
- To rejoin System2 and System3 to the cluster, the administrator must do the following:

- Shut down System2 and System3
- Fix the cluster interconnect links
- Restart System2 and System3

How I/O fencing works in different event scenarios

Table 9-2 describes how I/O fencing works to prevent data corruption in different failure event scenarios. For each event, review the corrective operator actions.

Table 9-2 I/O fencing scenarios

Event	Node A: What happens?	Node B: What happens?	Operator action
Both private networks fail.	Node A races for majority of coordination points. If Node A wins race for coordination points, Node A ejects Node B from the shared disks and continues.	Node B races for majority of coordination points. If Node B loses the race for the coordination points, Node B panics and removes itself from the cluster.	When Node B is ejected from cluster, repair the private networks before attempting to bring Node B back.
Both private networks function again after event above.	Node A continues to work.	Node B has crashed. It cannot start the database since it is unable to write to the data disks.	Restart Node B after private networks are restored.
One private network fails.	Node A prints message about an IOFENCE on the console but continues.	Node B prints message about an IOFENCE on the console but continues.	Repair private network. After network is repaired, both nodes automatically use it.

Table 9-2 I/O fencing scenarios (*continued*)

Event	Node A: What happens?	Node B: What happens?	Operator action
Node A hangs.	<p>Node A is extremely busy for some reason or is in the kernel debugger.</p> <p>When Node A is no longer hung or in the kernel debugger, any queued writes to the data disks fail because Node A is ejected. When Node A receives message from GAB about being ejected, it panics and removes itself from the cluster.</p>	<p>Node B loses heartbeats with Node A, and races for a majority of coordination points.</p> <p>Node B wins race for coordination points and ejects Node A from shared data disks.</p>	Repair or debug the node that hangs and reboot the node to rejoin the cluster.

Table 9-2 I/O fencing scenarios (*continued*)

Event	Node A: What happens?	Node B: What happens?	Operator action
<p>Nodes A and B and private networks lose power. Coordination points and data disks retain power.</p> <p>Power returns to nodes and they restart, but private networks still have no power.</p>	<p>Node A restarts and I/O fencing driver (vxfen) detects Node B is registered with coordination points. The driver does not see Node B listed as member of cluster because private networks are down. This causes the I/O fencing device driver to prevent Node A from joining the cluster. Node A console displays:</p> <p>Potentially a preexisting split brain. Dropping out of the cluster. Refer to the user documentation for steps required to clear preexisting split brain.</p>	<p>Node B restarts and I/O fencing driver (vxfen) detects Node A is registered with coordination points. The driver does not see Node A listed as member of cluster because private networks are down. This causes the I/O fencing device driver to prevent Node B from joining the cluster. Node B console displays:</p> <p>Potentially a preexisting split brain. Dropping out of the cluster. Refer to the user documentation for steps required to clear preexisting split brain.</p>	<p>Resolve preexisting split-brain condition.</p> <p>See “Fencing startup reports preexisting split-brain” on page 726.</p>

Table 9-2 I/O fencing scenarios (*continued*)

Event	Node A: What happens?	Node B: What happens?	Operator action
<p>Node A crashes while Node B is down. Node B comes up and Node A is still down.</p>	<p>Node A is crashed.</p>	<p>Node B restarts and detects Node A is registered with the coordination points. The driver does not see Node A listed as member of the cluster. The I/O fencing device driver prints message on console:</p> <pre>Potentially a preexisting split brain. Dropping out of the cluster. Refer to the user documentation for steps required to clear preexisting split brain.</pre>	<p>Resolve preexisting split-brain condition.</p> <p>See “Fencing startup reports preexisting split-brain” on page 726.</p>
<p>The disk array containing two of the three coordination points is powered off. No node leaves the cluster membership</p>	<p>Node A continues to operate as long as no nodes leave the cluster.</p>	<p>Node B continues to operate as long as no nodes leave the cluster.</p>	<p>Power on the failed disk array so that subsequent network partition does not cause cluster shutdown, or replace coordination points.</p> <p>See “Replacing I/O fencing coordinator disks when the cluster is online” on page 377.</p>

Table 9-2 I/O fencing scenarios (*continued*)

Event	Node A: What happens?	Node B: What happens?	Operator action
<p>The disk array containing two of the three coordination points is powered off.</p> <p>Node B gracefully leaves the cluster and the disk array is still powered off. Leaving gracefully implies a clean shutdown so that vxfs is properly unconfigured.</p>	<p>Node A continues to operate in the cluster.</p>	<p>Node B has left the cluster.</p>	<p>Power on the failed disk array so that subsequent network partition does not cause cluster shutdown, or replace coordination points.</p> <p>See “Replacing I/O fencing coordinator disks when the cluster is online” on page 377.</p>
<p>The disk array containing two of the three coordination points is powered off.</p> <p>Node B abruptly crashes or a network partition occurs between node A and node B, and the disk array is still powered off.</p>	<p>Node A races for a majority of coordination points. Node A fails because only one of the three coordination points is available. Node A panics and removes itself from the cluster.</p>	<p>Node B has left cluster due to crash or network partition.</p>	<p>Power on the failed disk array and restart I/O fencing driver to enable Node A to register with all coordination points, or replace coordination points.</p> <p>See “Replacing defective disks when the cluster is offline” on page 729.</p>

About cluster membership and data protection without I/O fencing

Proper seeding of the cluster and the use of low priority heartbeat cluster interconnect links are best practices with or without the use of I/O fencing. Best practice also recommends multiple cluster interconnect links between systems in the cluster. This allows GAB to differentiate between:

- A loss of all heartbeat links simultaneously, which is interpreted as a system failure. In this case, depending on failover configuration, HAD may attempt to restart the services that were running on that system on another system.
- A loss of all heartbeat links over time, which is interpreted as an interconnect failure. In this case, the assumption is made that there is a high probability that

the system is not down, and HAD does not attempt to restart the services on another system.

In order for this differentiation to have meaning, it is important to ensure the cluster interconnect links do not have a single point of failure, such as a network switch or Ethernet card.

About jeopardy

In all cases, when LLT on a system no longer receives heartbeat messages from another system on any of the configured LLT interfaces, GAB reports a change in membership.

When a system has only one interconnect link remaining to the cluster, GAB can no longer reliably discriminate between loss of a system and loss of the network. The reliability of the system's membership is considered at risk. A special membership category takes effect in this situation, called a jeopardy membership. This provides the best possible split-brain protection without membership arbitration and SCSI-3 capable devices.

When a system is placed in jeopardy membership status, two actions occur if the system loses the last interconnect link:

- VCS places service groups running on the system in autodisabled state. A service group in autodisabled state may failover on a resource or group fault, but cannot fail over on a system fault until the autodisabled flag is manually cleared by the administrator.
- VCS operates the system as a single system cluster. Other systems in the cluster are partitioned off in a separate cluster membership.

About Daemon Down Node Alive (DDNA)

Daemon Down Node Alive (DDNA) is a condition in which the VCS high availability daemon (HAD) on a node fails, but the node is running. When HAD fails, the hashadow process tries to bring HAD up again. If the hashadow process succeeds in bringing HAD up, the system leaves the DDNA membership and joins the regular membership.

In a DDNA condition, VCS does not have information about the state of service groups on the node. So, VCS places all service groups that were online on the affected node in the autodisabled state. The service groups that were online on the node cannot fail over.

Manual intervention is required to enable failover of autodisabled service groups. The administrator must release the resources running on the affected node, clear resource faults, and bring the service groups online on another node.

You can use the GAB registration monitoring feature to detect DDNA conditions.

See [“About GAB client registration monitoring”](#) on page 661.

Examples of VCS operation without I/O fencing

The following scenarios describe events, and how VCS responds, in a cluster without I/O fencing.

See [“Example: Four-system cluster without a low priority link”](#) on page 351.

See [“Example: Four-system cluster with low priority link”](#) on page 353.

Example: Four-system cluster without a low priority link

Consider a four-system cluster that has two private cluster interconnect heartbeat links. The cluster does not have any low priority link.

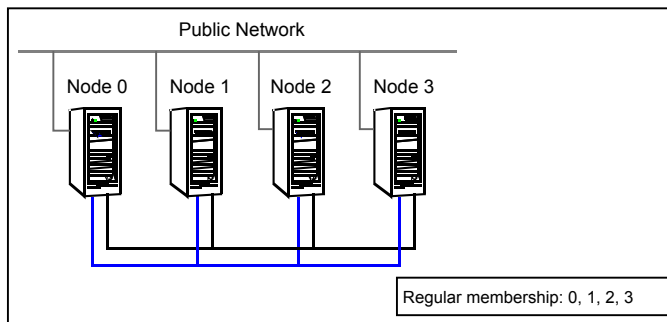

Cluster interconnect link failure

In this example, a link to System2 fails, leaving System2 with only one cluster interconnect link remaining.

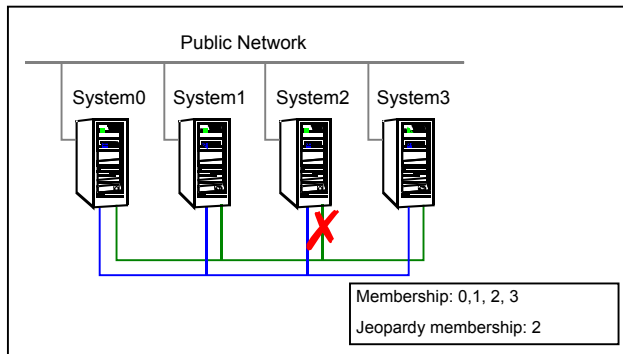

The cluster is reconfigured. Systems 0, 1, and 3 are in the regular membership and System2 in a jeopardy membership. Service groups on System2 are autodisabled. All normal cluster operations continue, including normal failover of service groups due to resource fault.

Cluster interconnect link failure followed by system failure

In this example, the link to System2 fails, and System2 is put in the jeopardy membership. Subsequently, System2 fails due to a power fault.

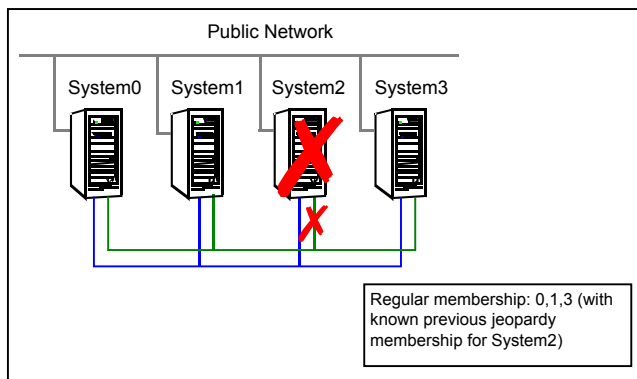

Systems 0, 1, and 3 recognize that System2 has faulted. The cluster is reformed. Systems 0, 1, and 3 are in a regular membership. When System2 went into jeopardy membership, service groups running on System2 were autodisabled. Even though the system is now completely failed, no other system can assume ownership of these service groups unless the system administrator manually clears the AutoDisabled flag on the service groups that were running on System2.

However, after the flag is cleared, these service groups can be manually brought online on other systems in the cluster.

All high priority cluster interconnect links fail

In this example, all high priority links to System2 fail. This can occur two ways:

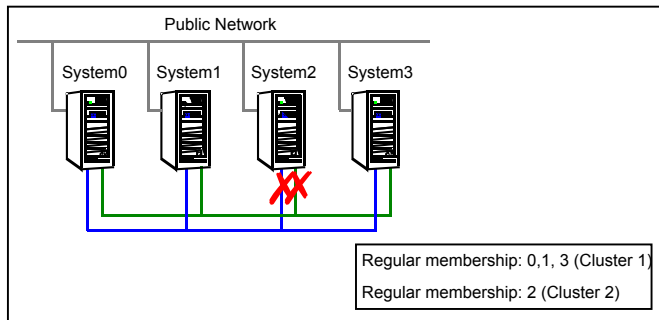

- Both links to System2 fail at the same time
System2 was never in jeopardy membership. Without a low priority link, the cluster splits into two subclusters, where System0, 1 and 3 are in one subcluster, and System2 is in another. This is a split brain scenario.
- Both links to System2 fail at different times
System2 was in a jeopardy membership when the second link failed, and therefore the service groups that were online on System2 were autodisabled. No other system can online these service groups without administrator intervention.
Systems 0, 1 and 3 form a mini-cluster. System2 forms another single- system mini-cluster. All service groups that were present on systems 0, 1 and 3 are autodisabled on System2.

Example: Four-system cluster with low priority link

Consider a four-system cluster that has two private cluster interconnect heartbeat links, and one public low priority link.

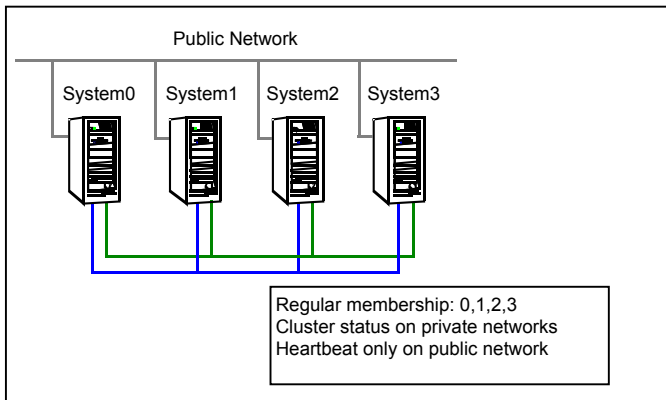

Cluster interconnect link failure

In this example, a link to System2 fails, leaving System2 with one cluster interconnect link and the low priority link remaining.

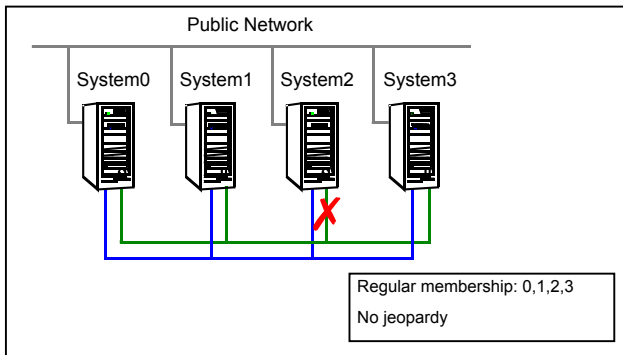

Other systems send all cluster status traffic to System2 over the remaining private link and use both private links for traffic between themselves. The low priority link continues carrying the heartbeat signal only. No jeopardy condition is in effect because two links remain to determine system failure.

Cluster interconnect link failure followed by system failure

In this example, the link to System2 fails. Because there is a low priority heartbeat link, System2 is not put in the jeopardy membership. Subsequently, System2 fails due to a power fault.

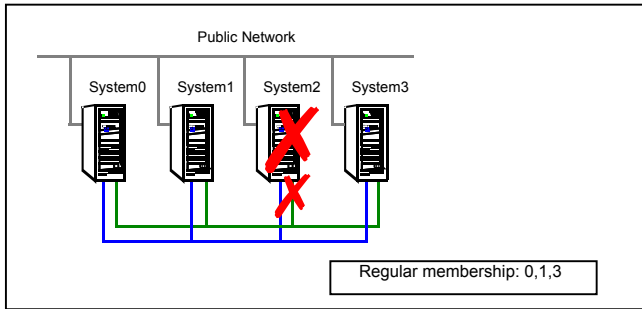

Systems 0, 1, and 3 recognize that System2 has faulted. The cluster is reformed. Systems 0, 1, and 3 are in a regular membership. The service groups on System2 that are configured for failover on system fault are attempted to be brought online on another target system, if one exists.

All high priority cluster interconnect links fail

In this example, both high priority cluster interconnect links to System2 fail, leaving System2 with only the low priority link remaining.

Cluster status communication is now routed over the low priority link to System2. System2 is placed in a jeopardy membership. The service groups on System2 are autodisabled, and the service group attribute AutoFailOver is set to 0, meaning the service group will not fail over on a system fault.

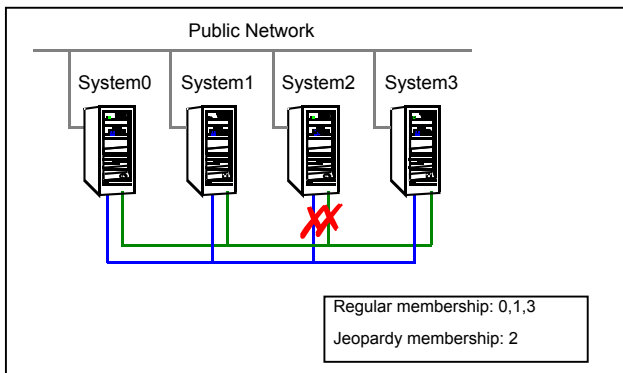

When a cluster interconnect link is re-established, all cluster status communications revert back to the cluster interconnect and the low priority link returns to sending heartbeat signal only. At this point, System2 is placed back in regular cluster membership.

Summary of best practices for cluster communications

Veritas Technologies recommends the following best practices for cluster communications to best support proper cluster membership and data protection:

- Properly seed the cluster by requiring all systems, and not just a subset of systems, to be present in the GAB membership before the cluster will automatically seed.
If every system is not present, manual intervention by the administrator must eliminate the possibility of a split brain condition before manually seeding the cluster.
- Configure multiple independent communication network links between cluster systems.
Networks should not have a single point of failure, such as a shared switch or Ethernet card.
- Low-priority LLT links in clusters with or without I/O fencing is recommended. In clusters without I/O fencing, this is critical.

Note: An exception to this is if the cluster uses fencing along with Cluster File Systems (CFS) or Oracle Real Application Clusters (RAC).

The reason for this is that low priority links are usually shared public network links. In the case where the main cluster interconnects fail, and the low priority link was the only remaining link, large amounts of data would be moved to the low priority link. This would potentially slow down the public network to unacceptable performance. Without a low priority link configured, membership arbitration would go into effect in this case, and some systems may be taken down, but the remaining systems would continue to run without impact to the public network.

It is not recommended to have a cluster with CFS or RAC without I/O fencing configured.

- Disable the console-abort sequence
Most UNIX systems provide a console-abort sequence that enables the administrator to halt and continue the processor. Continuing operations after the processor has stopped may corrupt data and is therefore unsupported by VCS.
When a system is halted with the abort sequence, it stops producing heartbeats. The other systems in the cluster consider the system failed and take over its services. If the system is later enabled with another console sequence, it

continues writing to shared storage as before, even though its applications have been restarted on other systems.

Veritas Technologies recommends disabling the console-abort sequence or creating an alias to force the `go` command to perform a restart on systems not running I/O fencing.

- Veritas Technologies recommends at least three coordination points to configure I/O fencing. You can use coordinator disks, CP servers, or a combination of both.

Select the smallest possible LUNs for use as coordinator disks. No more than three coordinator disks are needed in any configuration.

- Do not reconnect the cluster interconnect after a network partition without shutting down one side of the split cluster.

A common example of this happens during testing, where the administrator may disconnect the cluster interconnect and create a network partition. Depending on when the interconnect cables are reconnected, unexpected behavior can occur.

Administering I/O fencing

This chapter includes the following topics:

- [About administering I/O fencing](#)
- [About the vxfersthdw utility](#)
- [About the vxferadm utility](#)
- [About the vxferclearpre utility](#)
- [About the vxferswap utility](#)
- [About administering the coordination point server](#)
- [About migrating between disk-based and server-based fencing configurations](#)
- [Enabling or disabling the preferred fencing policy](#)
- [About I/O fencing log files](#)

About administering I/O fencing

The I/O fencing feature provides the following utilities that are available through the `VRTSvxfer` fileset:

<code>vxfersthdw</code>	Tests SCSI-3 functionality of the disks for I/O fencing See " About the vxfersthdw utility " on page 359.
<code>vxferconfig</code>	Configures and unconfigures I/O fencing Lists the coordination points used by the vxfer driver.

<code>vxfenadm</code>	Displays information on I/O fencing operations and manages SCSI-3 disk registrations and reservations for I/O fencing See “ About the <code>vxfenadm</code> utility ” on page 368.
<code>vxfcntlsthdw</code>	Removes SCSI-3 registrations and reservations from disks See “ About the <code>vxfcntlsthdw</code> utility ” on page 373.
<code>vxfcntlsthdw</code>	Replaces coordination points without stopping I/O fencing See “ About the <code>vxfcntlsthdw</code> utility ” on page 376.
<code>vxfcntlsthdw</code>	Generates the list of paths of disks in the disk group. This utility requires that Veritas Volume Manager (VxVM) is installed and configured.

The I/O fencing commands reside in the `/opt/VRTS/bin` folder. Make sure you added this folder path to the `PATH` environment variable.

Refer to the corresponding manual page for more information on the commands.

About the `vxfcntlsthdw` utility

You can use the `vxfcntlsthdw` utility to verify that shared storage arrays to be used for data support SCSI-3 persistent reservations and I/O fencing. During the I/O fencing configuration, the testing utility is used to test a single disk. The utility has other options that may be more suitable for testing storage devices in other configurations. You also need to test coordinator disk groups.

See the *Cluster Server Installation Guide* to set up I/O fencing.

The utility, which you can run from one system in the cluster, tests the storage used for data by setting and verifying SCSI-3 registrations on the disk or disks you specify, setting and verifying persistent reservations on the disks, writing data to the disks and reading it, and removing the registrations from the disks.

Refer also to the `vxfcntlsthdw(1M)` manual page.

General guidelines for using the `vxfcntlsthdw` utility

Review the following guidelines to use the `vxfcntlsthdw` utility:

- The utility requires two systems connected to the shared storage.

Caution: The tests overwrite and destroy data on the disks, unless you use the `-r` option.

- The two nodes must have SSH (default) or rsh communication. If you use rsh, launch the `vxfcntlsthdw` utility with the `-n` option.
After completing the testing process, you can remove permissions for communication and restore public network connections.
- To ensure both systems are connected to the same disk during the testing, you can use the `vxfcntlsthdw -i diskpath` command to verify a disk's serial number. See [“Verifying that the nodes see the same disk”](#) on page 372.
- For disk arrays with many disks, use the `-m` option to sample a few disks before creating a disk group and using the `-g` option to test them all.
- The utility indicates a disk can be used for I/O fencing with a message resembling:

```
The disk /dev/rhdisk75 is ready to be configured for
I/O Fencing on node sys1
```

If the utility does not show a message stating a disk is ready, verification has failed.

- The `-o` option overrides disk size-related errors and the utility proceeds with other tests, however, the disk may not setup correctly as the size may be smaller than the supported size. The supported disk size for data disks is 256 MB and for coordinator disks is 128 MB.
- If the disk you intend to test has existing SCSI-3 registration keys, the test issues a warning before proceeding.

About the vxfcntlsthdw command options

[Table 10-1](#) describes the methods that the utility provides to test storage devices.

Table 10-1 vxfcntlsthdw options

vxfcntlsthdw option	Description	When to use
-n	Utility uses rsh for communication.	Use when rsh is used for communication.
-r	Non-destructive testing. Testing of the disks for SCSI-3 persistent reservations occurs in a non-destructive way; that is, there is only testing for reads, not writes. Can be used with <code>-m</code> , <code>-f</code> , or <code>-g</code> options.	Use during non-destructive testing. See “Performing non-destructive testing on the disks using the -r option” on page 364.

Table 10-1 vxfcntlsthdw options (*continued*)

vxfcntlsthdw option	Description	When to use
-t	Testing of the return value of SCSI TEST UNIT (TUR) command under SCSI-3 reservations. A warning is printed on failure of TUR testing.	When you want to perform TUR testing.
-d	Use Dynamic Multi-Pathing (DMP) devices. Can be used with -c or -g options.	By default, the vxfcntlsthdw script picks up the DMP paths for disks in the disk group. If you want the script to use the raw paths for disks in the disk group, use the -w option.
-w	Use raw devices. Can be used with -c or -g options.	With the -w option, the vxfcntlsthdw script picks the operating system paths for disks in the disk group. By default, the script uses the -d option to pick up the DMP paths for disks in the disk group.
-c	Utility tests the coordinator disk group prompting for systems and devices, and reporting success or failure.	For testing disks in coordinator disk group. See “Testing the coordinator disk group using the -c option of vxfcntlsthdw” on page 362.
-m	Utility runs manually, in interactive mode, prompting for systems and devices, and reporting success or failure. Can be used with -r and -t options. -m is the default option.	For testing a few disks or for sampling disks in larger arrays. See “Testing the shared disks using the vxfcntlsthdw -m option” on page 364.
-f <i>filename</i>	Utility tests system and device combinations listed in a text file. Can be used with -r and -t options.	For testing several disks. See “Testing the shared disks listed in a file using the vxfcntlsthdw -f option” on page 366.

Table 10-1 `vxfcntlsthwdw` options (*continued*)

<code>vxfcntlsthwdw</code> option	Description	When to use
<code>-g disk_group</code>	Utility tests all disk devices in a specified disk group. Can be used with <code>-r</code> and <code>-t</code> options.	For testing many disks and arrays of disks. Disk groups may be temporarily created for testing purposes and destroyed (ungrouped) after testing. See “Testing all the disks in a disk group using the <code>vxfcntlsthwdw -g</code> option” on page 366.
<code>-o</code>	Utility overrides disk size-related errors.	For testing SCSI-3 Reservation compliance of disks, but, overrides disk size-related errors. See “Testing disks with the <code>vxfcntlsthwdw -o</code> option” on page 367.

Testing the coordinator disk group using the `-c` option of `vxfcntlsthwdw`

Use the `vxfcntlsthwdw` utility to verify disks are configured to support I/O fencing. In this procedure, the `vxfcntlsthwdw` utility tests the three disks, one disk at a time from each node.

The procedure in this section uses the following disks for example:

- From the node `sys1`, the disks are seen as `/dev/rhdisk75`, `/dev/rhdisk76`, and `/dev/rhdisk77`.
- From the node `sys2`, the same disks are seen as `/dev/rhdisk80`, `/dev/rhdisk81`, and `/dev/rhdisk82`.

Note: To test the coordinator disk group using the `vxfcntlsthwdw` utility, the utility requires that the coordinator disk group, `vxencoordg`, be accessible from two nodes.

To test the coordinator disk group using `vxfersthdw -c`

- 1 Use the `vxfersthdw` command with the `-c` option. For example:

```
# vxfersthdw -c vxfercoorddg
```

- 2 Enter the nodes you are using to test the coordinator disks:

```
Enter the first node of the cluster: sys1
```

```
Enter the second node of the cluster: sys2
```

- 3 Review the output of the testing process for both nodes for all disks in the coordinator disk group. Each disk should display output that resembles:

```
ALL tests on the disk /dev/rhdisk75 have PASSED.
```

```
The disk is now ready to be configured for I/O Fencing on node  
sys1 as a COORDINATOR DISK.
```

```
ALL tests on the disk /dev/rhdisk80 have PASSED.
```

```
The disk is now ready to be configured for I/O Fencing on node  
sys2 as a COORDINATOR DISK.
```

- 4 After you test all disks in the disk group, the `vxfercoorddg` disk group is ready for use.

Removing and replacing a failed disk

If a disk in the coordinator disk group fails verification, remove the failed disk or LUN from the `vxfercoorddg` disk group, replace it with another, and retest the disk group.

To remove and replace a failed disk

- 1 Use the `vxdiskadm` utility to remove the failed disk from the disk group.
Refer to the *Storage Foundation Administrator's Guide*.
- 2 Add a new disk to the node, initialize it, and add it to the coordinator disk group.
See the *Cluster Server Installation Guide* for instructions to initialize disks for I/O fencing and to set up coordinator disk groups.
If necessary, start the disk group.
See the *Storage Foundation Administrator's Guide* for instructions to start the disk group.
- 3 Retest the disk group.
See [“Testing the coordinator disk group using the -c option of vxfcntlsthdw”](#) on page 362.

Performing non-destructive testing on the disks using the `-r` option

You can perform non-destructive testing on the disk devices when you want to preserve the data.

To perform non-destructive testing on disks

- ◆ To test disk devices containing data you want to preserve, you can use the `-r` option with the `-m`, `-f`, or `-g` options.

For example, to use the `-m` option and the `-r` option, you can run the utility as follows:

```
# vxfcntlsthdw -rm
```

When invoked with the `-r` option, the utility does not use tests that write to the disks. Therefore, it does not test the disks for all of the usual conditions of use.

Testing the shared disks using the `vxfcntlsthdw -m` option

Review the procedure to test the shared disks. By default, the utility uses the `-m` option.

This procedure uses the `/dev/rhdisk75` disk in the steps.

If the utility does not show a message stating a disk is ready, verification has failed. Failure of verification can be the result of an improperly configured disk array. It can also be caused by a bad disk.

If the failure is due to a bad disk, remove and replace it. The `vxfersthdw` utility indicates a disk can be used for I/O fencing with a message resembling:

```
The disk /dev/rhdisk75 is ready to be configured for
I/O Fencing on node sys1
```

Note: For A/P arrays, run the `vxfersthdw` command only on active enabled paths.

To test disks using the `vxfersthdw` script

- 1 Make sure system-to-system communication is functioning properly.
- 2 From one node, start the utility.

```
# vxfersthdw [-n]
```

- 3 After reviewing the overview and warning that the tests overwrite data on the disks, confirm to continue the process and enter the node names.

```
***** WARNING!!!!!!!!!! *****
```

```
THIS UTILITY WILL DESTROY THE DATA ON THE DISK!!
```

```
Do you still want to continue : [y/n] (default: n) y
```

```
Enter the first node of the cluster: sys1
```

```
Enter the second node of the cluster: sys2
```

- 4 Enter the names of the disks you are checking. For each node, the disk may be known by the same name:

```
Enter the disk name to be checked for SCSI-3 PGR on node
sys1 in the format: /dev/rhdiskx
```

```
/dev/rhdisk75
```

```
Enter the disk name to be checked for SCSI-3 PGR on node
sys2 in the format: /dev/rhdiskx
```

```
Make sure it's the same disk as seen by nodes sys1 and sys2
/dev/rhdisk75
```

If the serial numbers of the disks are not identical, then the test terminates.

- 5 Review the output as the utility performs the checks and report its activities.

- 6** If a disk is ready for I/O fencing on each node, the utility reports success:

```
ALL tests on the disk /dev/rhdisk75 have PASSED
The disk is now ready to be configured for I/O Fencing on node
sys1
...
Removing test keys and temporary files, if any ...
.
.
```

- 7** Run the `vxfcntlsthdw` utility for each disk you intend to verify.

Testing the shared disks listed in a file using the `vxfcntlsthdw -f` option

Use the `-f` option to test disks that are listed in a text file. Review the following example procedure.

To test the shared disks listed in a file

- 1** Create a text file `disks_test` to test two disks shared by systems `sys1` and `sys2` that might resemble:

```
sys1 /dev/rhdisk75 sys2 /dev/rhdisk77
sys1 /dev/rhdisk76 sys2 /dev/rhdisk78
```

where the first disk is listed in the first line and is seen by `sys1` as `/dev/rhdisk75` and by `sys2` as `/dev/rhdisk77`. The other disk, in the second line, is seen as `/dev/rhdisk76` from `sys1` and `/dev/rhdisk78` from `sys2`. Typically, the list of disks could be extensive.

- 2** To test the disks, enter the following command:

```
# vxfcntlsthdw -f disks_test
```

The utility reports the test results one disk at a time, just as for the `-m` option.

Testing all the disks in a disk group using the `vxfcntlsthdw -g` option

Use the `-g` option to test all disks within a disk group. For example, you create a temporary disk group consisting of all disks in a disk array and test the group.

Note: Do not import the test disk group as shared; that is, do not use the `-s` option with the `vxchg import` command.

After testing, destroy the disk group and put the disks into disk groups as you need.

To test all the disks in a disk group

- 1 Create a disk group for the disks that you want to test.
- 2 Enter the following command to test the disk group `test_disks_dg`:

```
# vxfcntlsthaw -g test_disks_dg
```

The utility reports the test results one disk at a time.

Testing a disk with existing keys

If the utility detects that a coordinator disk has existing keys, you see a message that resembles:

```
There are Veritas I/O fencing keys on the disk. Please make sure
that I/O fencing is shut down on all nodes of the cluster before
continuing.
```

```
***** WARNING!!!!!!!!!! *****
```

```
THIS SCRIPT CAN ONLY BE USED IF THERE ARE NO OTHER ACTIVE NODES
IN THE CLUSTER! VERIFY ALL OTHER NODES ARE POWERED OFF OR
INCAPABLE OF ACCESSING SHARED STORAGE.
```

```
If this is not the case, data corruption will result.
```

```
Do you still want to continue : [y/n] (default: n) y
```

The utility prompts you with a warning before proceeding. You may continue as long as I/O fencing is not yet configured.

Testing disks with the `vxfcntlsthaw -o` option

Use the `-o` option to check for SCSI-3 reservation or registration compliance but not to test the disk size requirements.

Note that you can override a disk size-related error by using the `-o` flag. The `-o` flag lets the utility continue with tests related to SCSI-3 reservations, registrations, and other tests. However, the disks may not set up correctly as the disk size may be below the supported size for coordinator or data disks.

You can use the `-o` option with all the available `vxfcntlsthaw` options when you encounter size-related errors.

About the vxfenadm utility

Administrators can use the `vxfenadm` command to troubleshoot and test fencing configurations.

The command's options for use by administrators are as follows:

-s read the keys on a disk and display the keys in numeric, character, and node format

Note: The `-g` and `-G` options are deprecated. Use the `-s` option.

-i read SCSI inquiry information from device

-m register with disks

-n make a reservation with disks

-p remove registrations made by other systems

-r read reservations

-x remove registrations

Refer to the `vxfenadm(1M)` manual page for a complete list of the command options.

About the I/O fencing registration key format

The keys that the vxfen driver registers on the data disks and the coordinator disks consist of eight bytes. The key format is different for the coordinator disks and data disks.

The key format of the coordinator disks is as follows:

Byte	0	1	2	3	4	5	6	7
Value	V	F	cID 0x	cID 0x	cID 0x	cID 0x	nID 0x	nID 0x

where:

- VF is the unique identifier that carves out a namespace for the keys (consumes two bytes)
- cID 0x is the LLT cluster ID in hexadecimal (consumes four bytes)
- nID 0x is the LLT node ID in hexadecimal (consumes two bytes)

The vxfen driver uses this key format in both sybase mode of I/O fencing.

The key format of the data disks that are configured as failover disk groups under VCS is as follows:

Byte	0	1	2	3	4	5	6	7
Value	A+nID	V	C	S				

where nID is the LLT node ID

For example: If the node ID is 1, then the first byte has the value as B ('A' + 1 = B).

The key format of the data disks configured as parallel disk groups under Cluster Volume Manager (CVM) is as follows:

Byte	0	1	2	3	4	5	6	7
Value	A+nID	P	G	R	DGcount	DGcount	DGcount	DGcount

where DGcount is the count of disk groups in the configuration (consumes four bytes).

By default, CVM uses a unique fencing key for each disk group. However, some arrays have a restriction on the total number of unique keys that can be registered. In such cases, you can use the `same_key_for_alldgs` tunable parameter to change the default behavior. The default value of the parameter is `off`. If your configuration hits the storage array limit on total number of unique keys, you can change the value to `on` using the `vxdefault` command as follows:

```
# vxdefault set same_key_for_alldgs on
# vxdefault list
KEYWORD                CURRENT-VALUE    DEFAULT-VALUE
...
same_key_for_alldgs    on                off
...
```

If the tunable is changed to `on`, all subsequent keys that the CVM generates on disk group imports or creates have '0000' as their last four bytes (DGcount is 0). You must deport and re-import all the disk groups that are already imported for the changed value of the `same_key_for_alldgs` tunable to take effect.

Displaying the I/O fencing registration keys

You can display the keys that are currently assigned to the disks using the `vxfenadm` command.

The variables such as `disk_7`, `disk_8`, and `disk_9` in the following procedure represent the disk names in your setup.

To display the I/O fencing registration keys

- 1 To display the key for the disks, run the following command:

```
# vxfenadm -s disk_name
```

For example:

- To display the key for the coordinator disk `/dev/rhdisk75` from the system with node ID 1, enter the following command:

```
# vxfenadm -s /dev/rhdisk75
key[1]:
  [Numeric Format]:  86,70,68,69,69,68,48,48
  [Character Format]: VFDEED00
* [Node Format]: Cluster ID: 57069 Node ID: 0 Node Name: sys1
```

The `-s` option of `vxfenadm` displays all eight bytes of a key value in three formats. In the numeric format,

- The first two bytes, represent the identifier VF, contains the ASCII value 86, 70.
- The next four bytes contain the ASCII value of the cluster ID 57069 encoded in hex (0xDEED) which are 68, 69, 69, 68.
- The remaining bytes contain the ASCII value of the node ID 0 (0x00) which are 48, 48. Node ID 1 would be 01 and node ID 10 would be 0A. An asterisk before the Node Format indicates that the `vxfenadm` command is run from the node of a cluster where LLT is configured and is running.
- To display the keys on a CVM parallel disk group:

```
# vxfenadm -s /dev/vx/rdmp/disk_7
```

```
Reading SCSI Registration Keys...
```

```
Device Name: /dev/vx/rdmp/disk_7
```

```
Total Number Of Keys: 1
```

```
key[0]:
  [Numeric Format]:  66,80,71,82,48,48,48,49
  [Character Format]: BPGR0001
  [Node Format]: Cluster ID: unknown Node ID: 1 Node Name: sys2
```

- To display the keys on a Cluster Server (VCS) failover disk group:

```
# vxfenadm -s /dev/vx/rmdp/disk_8
```

```
Reading SCSI Registration Keys...
```

```
Device Name: /dev/vx/rmdp/disk_8
```

```
Total Number Of Keys: 1
```

```
key[0]:
```

```
[Numeric Format]: 65,86,67,83,0,0,0,0
```

```
[Character Format]: AVCS
```

```
[Node Format]: Cluster ID: unknown Node ID: 0 Node Name: sys1
```

2 To display the keys that are registered in all the disks specified in a disk file:

```
# vxfenadm -s all -f disk_filename
```

For example:

To display all the keys on coordinator disks:

```
# vxfenadm -s all -f /etc/vxfentab
```

```
Device Name: /dev/vx/rmdp/disk_9
```

```
Total Number Of Keys: 2
```

```
key[0]:
```

```
[Numeric Format]: 86,70,70,68,57,52,48,49
```

```
[Character Format]: VFFD9401
```

```
* [Node Format]: Cluster ID: 64916 Node ID: 1 Node Name: sys2
```

```
key[1]:
```

```
[Numeric Format]: 86,70,70,68,57,52,48,48
```

```
[Character Format]: VFFD9400
```

```
* [Node Format]: Cluster ID: 64916 Node ID: 0 Node Name: sys1
```

You can verify the cluster ID using the `lltstat -C` command, and the node ID using the `lltstat -N` command. For example:

```
# lltstat -C
```

```
57069
```

If the disk has keys that do not belong to a specific cluster, then the `vxfenadm` command cannot look up the node name for the node ID, and hence prints the node name as unknown. For example:

```
Device Name: /dev/vx/rmdp/disk_7
```

```
Total Number Of Keys: 1
```

```
key[0]:
```

```
[Numeric Format]: 86,70,45,45,45,45,48,49  
[Character Format]: VF---01  
[Node Format]: Cluster ID: unknown Node ID: 1 Node Name: sys2
```

For disks with arbitrary format of keys, the `vxfenadm` command prints all the fields as unknown. For example:

```
[Numeric Format]: 65,66,67,68,49,50,51,45  
[Character Format]: ABCD123-  
[Node Format]: Cluster ID: unknown Node ID: unknown  
Node Name: unknown
```

Verifying that the nodes see the same disk

To confirm whether a disk (or LUN) supports SCSI-3 persistent reservations, two nodes must simultaneously have access to the same disks. Because a shared disk is likely to have a different name on each node, check the serial number to verify the identity of the disk. Use the `vxfenadm` command with the `-i` option to verify that the same serial number for the LUN is returned on all paths to the LUN.

For example, an EMC disk is accessible by the `/dev/rhdisk75` path on node A and the `/dev/rhdisk76` path on node B.

To verify that the nodes see the same disks

- 1 Verify the connection of the shared storage for data to two of the nodes on which you installed Cluster Server.
- 2 From node A, enter the following command:

```
# vxfcntladm -i /dev/rhdisk75

Vendor id      : EMC
Product id    : SYMMETRIX
Revision      : 5567
Serial Number  : 42031000a
```

The same serial number information should appear when you enter the equivalent command on node B using the `/dev/rhdisk76` path.

On a disk from another manufacturer, Hitachi Data Systems, the output is different and may resemble:

```
# vxfcntladm -i /dev/rhdisk76

Vendor id      : HITACHI
Product id    : OPEN-3
Revision      : 0117
Serial Number  : 0401EB6F0002
```

Refer to the `vxfcntladm(1M)` manual page for more information.

About the `vxfcntlpre` utility

You can use the `vxfcntlpre` utility to remove SCSI-3 registrations and reservations on the disks as well as coordination point servers.

See [“Removing preexisting keys”](#) on page 374.

This utility now supports server-based fencing. You can use the `vxfcntlpre` utility to clear registrations from coordination point servers (CP servers) for the current cluster. The local node from where you run the utility must have the UUID of the current cluster at the `/etc/vx/.uuids` directory in the `clusuuid` file. If the UUID file for that cluster is not available on the local node, the utility does not clear registrations from the coordination point servers.

Note: You can use the utility to remove the registration keys and the registrations (reservations) from the set of coordinator disks for any cluster you specify in the command, but you can only clear registrations of your current cluster from the CP servers. Also, you may experience delays while clearing registrations on the coordination point servers because the utility tries to establish a network connection with the IP addresses used by the coordination point servers. The delay may occur because of a network issue or if the IP address is not reachable or is incorrect.

For any issues you encounter with the `vxfenclearpre` utility, you can refer to the log file at, `/var/VRTSvcs/log/vxfen/vxfen.log` file.

See [“Issues during fencing startup on VCS cluster nodes set up for server-based fencing”](#) on page 733.

Removing preexisting keys

If you encountered a split-brain condition, use the `vxfenclearpre` utility to remove CP Servers, SCSI-3 registrations, and reservations on the coordinator disks, Coordination Point servers, as well as on the data disks in all shared disk groups.

You can also use this procedure to remove the registration and reservation keys of another node or other nodes on shared disks or CP server.

To clear keys after split-brain

- 1 Stop VCS on all nodes.

```
# hstop -all
```

- 2 Make sure that the port `h` is closed on all the nodes. Run the following command on each node to verify that the port `h` is closed:

```
# gabconfig -a
```

Port `h` must not appear in the output.

- 3 Stop I/O fencing on all nodes. Enter the following command on each node:

```
# /etc/init.d/vxfen.rc stop
```

- 4 If you have any applications that run outside of VCS control that have access to the shared storage, then shut down all other nodes in the cluster that have access to the shared storage. This prevents data corruption.

- 5 Start the `vxfenclearpre` script:

```
# /opt/VRTSvcs/vxfen/bin/vxfenclearpre
```

- 6 Read the script's introduction and warning. Then, you can choose to let the script run.

```
Do you still want to continue: [y/n] (default : n) y
```

The script cleans up the disks and displays the following status messages.

```
Cleaning up the coordinator disks...
```

```
Cleared keys from n out of n disks,  
where n is the total number of disks.
```

```
Successfully removed SCSI-3 persistent registrations  
from the coordinator disks.
```

```
Cleaning up the Coordination Point Servers...
```

```
.....  
[10.209.80.194]:50001: Cleared all registrations  
[10.209.75.118]:443: Cleared all registrations
```

```
Successfully removed registrations from the Coordination Point Servers.
```

```
Cleaning up the data disks for all shared disk groups ...
```

```
Successfully removed SCSI-3 persistent registration and  
reservations from the shared data disks.
```

```
See the log file /var/VRTSvcs/log/vxfen/vxfen.log
```

```
You can retry starting fencing module. In order to restart the whole  
product, you might want to reboot the system.
```

- 7 Start the fencing module on all the nodes.

```
# /etc/init.d/vxfen.rc start
```

- 8 Start VCS on all nodes.

```
# hastart
```

About the `vxfsnwap` utility

The `vxfsnwap` utility allows you to add, remove, and replace coordinator points in a cluster that is online. The utility verifies that the serial number of the new disks are identical on all the nodes and the new disks can support I/O fencing.

This utility supports both disk-based and server-based fencing.

The utility uses SSH, RSH, or `hacli` for communication between nodes in the cluster. Before you execute the utility, ensure that communication between nodes is set up in one these communication protocols.

Refer to the `vxfsnwap(1M)` manual page.

See the *Cluster Server Installation Guide* for details on the I/O fencing requirements.

You can replace the coordinator disks without stopping I/O fencing in the following cases:

- The disk becomes defective or inoperable and you want to switch to a new disk group.
See [“Replacing I/O fencing coordinator disks when the cluster is online”](#) on page 377.
See [“Replacing the coordinator disk group in a cluster that is online”](#) on page 380.
If you want to replace the coordinator disks when the cluster is offline, you cannot use the `vxfsnwap` utility. You must manually perform the steps that the utility does to replace the coordinator disks.
See [“Replacing defective disks when the cluster is offline”](#) on page 729.
- New disks are available to act as coordinator disks.
See [“Adding disks from a recovered site to the coordinator disk group”](#) on page 385.
- The keys that are registered on the coordinator disks are lost.
In such a case, the cluster might panic when a network partition occurs. You can replace the coordinator disks with the same disks using the `vxfsnwap` command. During the disk replacement, the missing keys register again without any risk of data corruption.
See [“Refreshing lost keys on coordinator disks”](#) on page 387.

In server-based fencing configuration, you can use the `vxfsnwap` utility to perform the following tasks:

- Perform a planned replacement of customized coordination points (CP servers or SCSI-3 disks).
See [“Replacing coordination points for server-based fencing in an online cluster”](#) on page 398.
- Refresh the I/O fencing keys that are registered on the coordination points.

See [“Refreshing registration keys on the coordination points for server-based fencing”](#) on page 400.

You can also use the vxfenswap utility to migrate between the disk-based and the server-based fencing without incurring application downtime in the VCS cluster.

See [“Migrating from disk-based to server-based fencing in an online cluster”](#) on page 408.

See [“Migrating from server-based to disk-based fencing in an online cluster”](#) on page 409.

If the vxfenswap operation is unsuccessful, then you can use the `-a cancel` of the `vxfenswap` command to manually roll back the changes that the vxfenswap utility does.

- For disk-based fencing, use the `vxfenswap -g diskgroup -a cancel` command to cancel the vxfenswap operation.
You must run this command if a node fails during the process of disk replacement, or if you aborted the disk replacement.
- For server-based fencing, use the `vxfenswap -a cancel` command to cancel the vxfenswap operation.

Replacing I/O fencing coordinator disks when the cluster is online

Review the procedures to add, remove, or replace one or more coordinator disks in a cluster that is operational.

Warning: The cluster might panic if any node leaves the cluster membership before the vxfenswap script replaces the set of coordinator disks.

To replace a disk in a coordinator disk group when the cluster is online

- 1 Make sure system-to-system communication is functioning properly.
- 2 Determine the value of the FaultTolerance attribute.

```
# hares -display coordpoint -attribute FaultTolerance -localclus
```

- 3 Estimate the number of coordination points you plan to use as part of the fencing configuration.
- 4 Set the value of the FaultTolerance attribute to 0.

Note: It is necessary to set the value to 0 because later in the procedure you need to reset the value of this attribute to a value that is lower than the number of coordination points. This ensures that the Coordpoint Agent does not fault.

- 5 Check the existing value of the LevelTwoMonitorFreq attribute.

```
#hares -display coordpoint -attribute LevelTwoMonitorFreq -localclus
```

Note: Make a note of the attribute value before you proceed to the next step. After migration, when you re-enable the attribute you want to set it to the same value.

You can also run the `hares -display coordpoint` to find out whether the LevelTwoMonitorFreq value is set.

- 6 Disable level two monitoring of CoordPoint agent.

```
# hares -modify coordpoint LevelTwoMonitorFreq 0
```

- 7 Make sure that the cluster is online.

```
# vxfenadm -d
```

```
I/O Fencing Cluster Information:
```

```
=====
```

```
Fencing Protocol Version: 201
```

```
Fencing Mode: SCSI3
```

```
Fencing SCSI3 Disk Policy: dmp
```

```
Cluster Members:
```

```
 * 0 (sys1)
```

```
  1 (sys2)
```

```
RFSM State Information:
```

```
 node 0 in state 8 (running)
```

```
 node 1 in state 8 (running)
```

- 8 Import the coordinator disk group.

The file `/etc/vxfendg` includes the name of the disk group (typically, `vxencoordg`) that contains the coordinator disks, so use the command:

```
# vxdg -tfc import `cat /etc/vxfendg`
```

where:

-t specifies that the disk group is imported only until the node restarts.

-f specifies that the import is to be done forcibly, which is necessary if one or more disks is not accessible.

-C specifies that any import locks are removed.

- 9** If your setup uses `VRTSvxvm` *version*, then skip to step [10](#). You need not set `coordinator=off` to add or remove disks. For other VxVM versions, perform this step:

Where *version* is the specific release version.

Turn off the coordinator attribute value for the coordinator disk group.

```
# vxdg -g vxfencoorddg set coordinator=off
```

- 10** To remove disks from the coordinator disk group, use the VxVM disk administrator utility `vxdiskadm`.
- 11** Perform the following steps to add new disks to the coordinator disk group:

- Add new disks to the node.
- Initialize the new disks as VxVM disks.
- Check the disks for I/O fencing compliance.
- Add the new disks to the coordinator disk group and set the coordinator attribute value as "on" for the coordinator disk group.

See the *Cluster Server Installation Guide* for detailed instructions.

Note that though the disk group content changes, the I/O fencing remains in the same state.

- 12** From one node, start the vxfenswap utility. You must specify the disk group to the utility.

The utility performs the following tasks:

- Backs up the existing `/etc/vxfentab` file.
- Creates a test file `/etc/vxfentab.test` for the disk group that is modified on each node.
- Reads the disk group you specified in the vxfenswap command and adds the disk group to the `/etc/vxfentab.test` file on each node.
- Verifies that the serial number of the new disks are identical on all the nodes. The script terminates if the check fails.
- Verifies that the new disks can support I/O fencing on each node.

- 13** If the disk verification passes, the utility reports success and asks if you want to commit the new set of coordinator disks.

- 14** Confirm whether you want to clear the keys on the coordination points and proceed with the vxfsnwap operation.

```
Do you want to clear the keys on the coordination points
and proceed with the vxfsnwap operation? [y/n] (default: n) y
```

- 15** Review the message that the utility displays and confirm that you want to commit the new set of coordinator disks. Else skip to step 16.

```
Do you wish to commit this change? [y/n] (default: n) y
```

If the utility successfully commits, the utility moves the `/etc/vxfentab.test` file to the `/etc/vxfentab` file.

- 16** If you do not want to commit the new set of coordinator disks, answer n.

The vxfsnwap utility rolls back the disk replacement operation.

- 17** If coordinator flag was set to off in step 9, then set it on.

```
# vxldg -g vxfencoorddg set coordinator=on
```

- 18** Deport the diskgroup.

```
# vxldg deport vxfencoorddg
```

- 19** Re-enable the LevelTwoMonitorFreq attribute of the CoordPoint agent. You may want to use the value that was set before disabling the attribute.

```
# hares -modify coordpoint LevelTwoMonitorFreq Frequencyvalue
```

where *Frequencyvalue* is the value of the attribute.

- 20** Set the FaultTolerance attribute to a value that is lower than 50% of the total number of coordination points.

For example, if there are four (4) coordination points in your configuration, then the attribute value must be lower than two (2). If you set it to a higher value than two (2) the CoordPoint agent faults.

Replacing the coordinator disk group in a cluster that is online

You can also replace the coordinator disk group using the vxfsnwap utility. The following example replaces the coordinator disk group vxfencoorddg with a new disk group vxfendg.

To replace the coordinator disk group

- 1 Make sure system-to-system communication is functioning properly.
- 2 Determine the value of the FaultTolerance attribute.

```
# hares -display coordpoint -attribute FaultTolerance -localclus
```

- 3 Estimate the number of coordination points you plan to use as part of the fencing configuration.
- 4 Set the value of the FaultTolerance attribute to 0.

Note: It is necessary to set the value to 0 because later in the procedure you need to reset the value of this attribute to a value that is lower than the number of coordination points. This ensures that the Coordpoint Agent does not fault.

- 5 Check the existing value of the LevelTwoMonitorFreq attribute.

```
# hares -display coordpoint -attribute LevelTwoMonitorFreq -localclus
```

Note: Make a note of the attribute value before you proceed to the next step. After migration, when you re-enable the attribute you want to set it to the same value.

- 6 Disable level two monitoring of CoordPoint agent.

```
# haconf -makerw
```

```
# hares -modify coordpoint LevelTwoMonitorFreq 0
```

```
# haconf -dump -makeo
```

7 Make sure that the cluster is online.

```
# vxfenadm -d
```

```
I/O Fencing Cluster Information:
=====
Fencing Protocol Version: 201
Fencing Mode: SCSI3
Fencing SCSI3 Disk Policy: dmp
Cluster Members:
  * 0 (sys1)
  1 (sys2)
RFSM State Information:
  node 0 in state 8 (running)
  node 1 in state 8 (running)
```

8 Find the name of the current coordinator disk group (typically vxfencoordg) that is in the /etc/vxfendg file.

```
# cat /etc/vxfendg
vxfencoordg
```

9 Find the alternative disk groups available to replace the current coordinator disk group.

```
# vxdisk -o alldgs list
```

DEVICE	TYPE	DISK	GROUP	STATUS
rhdisk64	auto:cdsdisk	-	(vxfendg)	online
rhdisk65	auto:cdsdisk	-	(vxfendg)	online
rhdisk66	auto:cdsdisk	-	(vxfendg)	online
rhdisk75	auto:cdsdisk	-	(vxfencoordg)	online
rhdisk76	auto:cdsdisk	-	(vxfencoordg)	online
rhdisk77	auto:cdsdisk	-	(vxfencoordg)	online

10 Validate the new disk group for I/O fencing compliance. Run the following command:

```
# vxfentsthdw -c vxfendg
```

See “Testing the coordinator disk group using the -c option of vxfentsthdw” on page 362.

- 11** If the new disk group is not already deported, run the following command to deport the disk group:

```
# vxdg deport vxfendg
```

- 12** Perform one of the following:

- Create the `/etc/vxfenmode.test` file with new fencing mode and disk policy information.
- Edit the existing the `/etc/vxfenmode` with new fencing mode and disk policy information and remove any preexisting `/etc/vxfenmode.test` file.

Note that the format of the `/etc/vxfenmode.test` file and the `/etc/vxfenmode` file is the same.

See the *Cluster Server Installation Guide* for more information.

- 13** From any node, start the vxfenswap utility. For example, if vxfendg is the new disk group that you want to use as the coordinator disk group:

```
# vxfenswap -g vxfendg [-n]
```

The utility performs the following tasks:

- Backs up the existing `/etc/vxfentab` file.
- Creates a test file `/etc/vxfentab.test` for the disk group that is modified on each node.
- Reads the disk group you specified in the vxfenswap command and adds the disk group to the `/etc/vxfentab.test` file on each node.
- Verifies that the serial number of the new disks are identical on all the nodes. The script terminates if the check fails.
- Verifies that the new disk group can support I/O fencing on each node.

- 14** If the disk verification passes, the utility reports success and asks if you want to replace the coordinator disk group.

- 15** Confirm whether you want to clear the keys on the coordination points and proceed with the vxfenswap operation.

```
Do you want to clear the keys on the coordination points  
and proceed with the vxfenswap operation? [y/n] (default: n) y
```

- 16** Review the message that the utility displays and confirm that you want to replace the coordinator disk group. Else skip to step [21](#).

```
Do you wish to commit this change? [y/n] (default: n) y
```

If the utility successfully commits, the utility moves the `/etc/vxfentab.test` file to the `/etc/vxfentab` file.

The utility also updates the `/etc/vxfendg` file with this new disk group.

- 17** Import the new disk group if it is not already imported before you set the coordinator flag "on".

```
# vxdg -t import vxfendg
```

- 18** Set the coordinator attribute value as "on" for the new coordinator disk group.

```
# vxdg -g vxfendg set coordinator=on
```

Set the coordinator attribute value as "off" for the old disk group.

```
# vxdg -g vxfencoordg set coordinator=off
```

- 19** Deport the new disk group.

```
# vxdg deport vxfendg
```

- 20** Verify that the coordinator disk group has changed.

```
# cat /etc/vxfendg  
vxfendg
```

The swap operation for the coordinator disk group is complete now.

- 21** If you do not want to replace the coordinator disk group, answer n at the prompt.

The vxfenswap utility rolls back any changes to the coordinator disk group.

- 22** Re-enable the `LevelTwoMonitorFreq` attribute of the `CoordPoint` agent. You may want to use the value that was set before disabling the attribute.

```
# haconf -makerw

# hares -modify coordpoint LevelTwoMonitorFreq Frequencyvalue

# haconf -dump -makero
```

where *Frequencyvalue* is the value of the attribute.

- 23** Set the `FaultTolerance` attribute to a value that is lower than 50% of the total number of coordination points.

For example, if there are four (4) coordination points in your configuration, then the attribute value must be lower than two (2). If you set it to a higher value than two (2) the `CoordPoint` agent faults.

Adding disks from a recovered site to the coordinator disk group

In a campus cluster environment, consider a case where the primary site goes down and the secondary site comes online with a limited set of disks. When the primary site restores, the primary site's disks are also available to act as coordinator disks. You can use the `vxferwap` utility to add these disks to the coordinator disk group.

See [“About I/O fencing in campus clusters”](#) on page 643.

To add new disks from a recovered site to the coordinator disk group

- 1 Make sure system-to-system communication is functioning properly.
- 2 Make sure that the cluster is online.

```
# vxferadm -d

I/O Fencing Cluster Information:
=====
Fencing Protocol Version: 201
Fencing Mode: SCSI3
Fencing SCSI3 Disk Policy: dmp
Cluster Members:
  * 0 (sys1)
  1 (sys2)
RFSM State Information:
  node 0 in state 8 (running)
  node 1 in state 8 (running)
```

3 Verify the name of the coordinator disk group.

```
# cat /etc/vxfendg
vxfencoorddg
```

4 Run the following command:

```
# vxdisk -o alldgs list

DEVICE      TYPE      DISK GROUP      STATUS
rhdisk75    auto:cdsdisk  - (vxfencoorddg)  online
rhdisk75    auto      - -             offline
rhdisk75    auto      - -             offline
```

5 Verify the number of disks used in the coordinator disk group.

```
# vxfenconfig -l
I/O Fencing Configuration Information:
=====
Count                : 1
Disk List
Disk Name            Major  Minor  Serial Number      Policy
/dev/vx/rdmp/rhdisk75      32  48  R450 00013154 0312      dmp
```

6 When the primary site comes online, start the vxfenswap utility on any node in the cluster:

```
# vxfenswap -g vxfencoorddg [-n]
```

7 Verify the count of the coordinator disks.

```
# vxfenconfig -l
I/O Fencing Configuration Information:
=====
Single Disk Flag      : 0
Count                : 3
Disk List
Disk Name            Major  Minor  Serial Number      Policy
/dev/vx/rdmp/rhdisk75      32  48  R450 00013154 0312      dmp
/dev/vx/rdmp/rhdisk76      32  32  R450 00013154 0313      dmp
/dev/vx/rdmp/rhdisk77      32  16  R450 00013154 0314      dmp
```

Refreshing lost keys on coordinator disks

If the coordinator disks lose the keys that are registered, the cluster might panic when a network partition occurs.

You can use the vxfenswap utility to replace the coordinator disks with the same disks. The vxfenswap utility registers the missing keys during the disk replacement.

To refresh lost keys on coordinator disks

- 1 Make sure system-to-system communication is functioning properly.
- 2 Make sure that the cluster is online.

```
# vxfenadm -d
```

```
I/O Fencing Cluster Information:
```

```
=====
```

```
Fencing Protocol Version: 201
```

```
Fencing Mode: SCSI3
```

```
Fencing SCSI3 Disk Policy: dmp
```

```
Cluster Members:
```

```
* 0 (sys1)
```

```
1 (sys2)
```

```
RFSM State Information:
```

```
node 0 in state 8 (running)
```

```
node 1 in state 8 (running)
```

- 3 Run the following command to view the coordinator disks that do not have keys:

```
# vxfenadm -s all -f /etc/vxfentab
```

```
Device Name: /dev/vx/rmdp/rhdisk75
```

```
Total Number of Keys: 0
```

```
No keys...
```

```
...
```

- 4 Copy the /etc/vxfenmode file to the /etc/vxfenmode.test file.

This ensures that the configuration details of both the files are the same.

- 5 On any node, run the following command to start the `vxfsnwap` utility:

```
# vxfsnwap -g vxfsncoorddg [-n]
```

- 6 Verify that the keys are atomically placed on the coordinator disks.

```
# vxfsnadm -s all -f /etc/vxfsntab
```

```
Device Name: /dev/vx/rmdp/rhdisk75
```

```
Total Number of Keys: 4
```

```
...
```

About administering the coordination point server

This section describes how to perform administrative and maintenance tasks on the coordination point server (CP server).

For more information about the `cpsadm` command and the associated command options, see the `cpsadm(1M)` manual page.

CP server operations (`cpsadm`)

[Table 10-2](#) lists coordination point server (CP server) operations and required privileges.

Table 10-2 User privileges for CP server operations

CP server operations	CP server Operator	CP server Admin
<code>add_cluster</code>	–	✓
<code>rm_clus</code>	–	✓
<code>add_node</code>	✓	✓
<code>rm_node</code>	✓	✓
<code>add_user</code>	–	✓
<code>rm_user</code>	–	✓
<code>add_clus_to_user</code>	–	✓
<code>rm_clus_from_user</code>	–	✓
<code>reg_node</code>	✓	✓

Table 10-2 User privileges for CP server operations (*continued*)

CP server operations	CP server Operator	CP server Admin
unreg_node	✓	✓
preempt_node	✓	✓
list_membership	✓	✓
list_nodes	✓	✓
list_users	✓	✓
halt_cps	–	✓
db_snapshot	–	✓
ping_cps	✓	✓
client_preupgrade	✓	✓
server_preupgrade	✓	✓
list_protocols	✓	✓
list_version	✓	✓
list_ports	–	✓
add_port	–	✓
rm_port	–	✓

Cloning a CP server

Cloning a CP server greatly reduces the time and effort of assigning a new CP server to your cluster. Since the cloning replicates the existing CP server, you are saved from running the `vxfsenswap` utilities on each node connected to the CP server. Therefore, you can perform the CP server maintenance without much hassle.

In this procedure, the following terminology is used to refer to the existing and cloned CP servers:

- `cps1`: Indicates the existing CP server
- `cps2`: Indicates the clone of `cps1`

Prerequisite: Before cloning a CP server, make sure that the existing CP server `cps1` is up and running and fencing is configured on at least one client of `cps1` in order to verify that the client can talk to `cps2`.

To clone the CP server (cps1):

- 1** Install and configure Cluster Server (VCS) on the system where you want to clone cps1.
Refer the InfoScale Installation Guide for procedure on installing the Cluster Server
- 2** Copy the cps1 database and UUID to the system where you want to clone cps1. You can copy the database and UUID from `/etc/VRTScps/db`.
- 3** Copy CP server configuration file of cps1 from `/etc/vxcps.conf` to the target system for cps2.
- 4** Copy the CP server and fencing certificates and keys on cps1 from `/var/VRTScps/security` and `/var/VRTSvxfen/security` directories respectively to the target system for cps2.
- 5** Copy main.cf of cps1 to the target system for cps2 at `/etc/VRTSvcs/conf/config/main.cf`.
- 6** On the target system for cps2, stop VCS and perform the following in main.cf:
 - Replace all the instances of system name with cps2 system name.
 - Change the device attribute under NIC and IP resources to cps2 values.
- 7** Copy `/opt/VRTScps/bin/QuorumTypes.cf` from cps1 to the target cps2 system.
- 8** Offline CP server service group if it is online on cps1.

```
# /opt/VRTSvcs/bin/hagrp -offline CPSSG -sys <cps1>
```

- 9** Start VCS on the target system for cps2. The CP server service group must come online on target system for cps2 and the system becomes a clone of cps1.

```
# /opt/VRTSvcs/bin/hastart
```

- 10** Run the following command on cps2 to verify if the clone was successful and is running well.

```
# cpsadm -s <server_vip> -a ping_cps
CPS INFO V-97-1400-458 CP server successfully pinged
```

- 11** Verify if the Co-ordination Point agent service group is Online on the client clusters.

```
# /opt/VRTSvcs/bin/hares -state
Resource           Attribute  System  Value
RES_phantom_vxfen  State     system1 ONLINE
coordpoint         State     system1 ONLINE

# /opt/VRTSvcs/bin/hagrp -state
Group              Attribute  System  Value
vxfen              State     system1 |ONLINE|
```

Note: The cloned cps2 system must be in the same subnet of cps1. Make sure that the port (default 443) used for CP server configuration is free for cps2).

Adding and removing VCS cluster entries from the CP server database

- To add a VCS cluster to the CP server database

Type the following command:

```
# cpsadm -s cp_server -a add_clus -c cluster_name -u uuid
```

- To remove a VCS cluster from the CP server database

Type the following command:

```
# cpsadm -s cp_server -a rm_clus -u uuid
```

cp_server The CP server's virtual IP address or virtual hostname.

cluster_name The VCS cluster name.

uuid The UUID (Universally Unique ID) of the VCS cluster.

Adding and removing a VCS cluster node from the CP server database

- To add a VCS cluster node from the CP server database

Type the following command:

```
# cpsadm -s cp_server -a add_node -u uuid -n nodeid
-h host
```

- To remove a VCS cluster node from the CP server database

Type the following command:

```
# cpsadm -s cp_server -a rm_node -u uuid -n nodeid
```

cp_server The CP server's virtual IP address or virtual hostname.

uuid The UUID (Universally Unique ID) of the VCS cluster.

nodeid The node id of the VCS cluster node.

host Hostname

Adding or removing CP server users

- To add a user

Type the following command:

```
# cpsadm -s cp_server -a add_user -e user_name -f user_role
-g domain_type -u uuid
```

- To remove a user

Type the following command:

```
# cpsadm -s cp_server -a rm_user -e user_name -g domain_type
```

cp_server The CP server's virtual IP address or virtual hostname.

user_name The user to be added to the CP server configuration.

user_role The user role, either `cps_admin` or `cps_operator`.

domain_type The domain type, for example `vx`, `unixpwd`, `nis`, etc.

uuid The UUID (Universally Unique ID) of the VCS cluster.

Listing the CP server users

To list the CP server users

Type the following command:

```
# cpsadm -s cp_server -a list_users
```

Listing the nodes in all the VCS clusters

To list the nodes in all the VCS cluster

Type the following command:

```
# cpsadm -s cp_server -a list_nodes
```

Listing the membership of nodes in the VCS cluster

To list the membership of nodes in VCS cluster

Type the following command:

```
# cpsadm -s cp_server -a list_membership -c cluster_name
```

cp_server The CP server's virtual IP address or virtual hostname.

cluster_name The VCS cluster name.

Preempting a node

Use the following command to preempt a node.

To preempt a node

◆ Type the following command:

```
# cpsadm -s cp_server -a preempt_node -u uuid -n nodeid  
-v victim_node id
```

cp_server The CP server's virtual IP address or virtual hostname.

uuid The UUID (Universally Unique ID) of the VCS cluster.

nodeid The node id of the VCS cluster node.

victim_node id Node id of one or more victim nodes.

Registering and unregistering a node

- To register a node

Type the following command:

```
# cpsadm -s cp_server -a reg_node -u uuid -n nodeid
```

- To unregister a node

Type the following command:

```
# cpsadm -s cp_server -a unreg_node -u uuid -n nodeid
```

<i>cp_server</i>	The CP server's virtual IP address or virtual hostname.
<i>uuid</i>	The UUID (Universally Unique ID) of the VCS cluster.
<i>nodeid</i>	The nodeid of the VCS cluster node.

Enable and disable access for a user to a VCS cluster

- To enable access for a user to a VCS cluster

Type the following command:

```
# cpsadm -s cp_server -a add_clus_to_user -e user  
-f user_role -g domain_type -u uuid
```

- To disable access for a user to a VCS cluster

Type the following command:

```
# cpsadm -s cp_server -a rm_clus_from_user -e user_name  
-f user_role -g domain_type -u uuid
```

<i>cp_server</i>	The CP server's virtual IP address or virtual hostname.
<i>user_name</i>	The user name to be added to the CP server.
<i>user_role</i>	The user role, either <code>cps_admin</code> or <code>cps_operator</code> .
<i>domain_type</i>	The domain type, for example <code>vx</code> , <code>unixpwd</code> , <code>nis</code> , etc.
<i>uuid</i>	The UUID (Universally Unique ID) of the VCS cluster

Starting and stopping CP server outside VCS control

You can start or stop coordination point server (CP server) outside VCS control.

To start CP server outside VCS control

- 1 Run the `vxcperv` binary directly:

```
# /opt/VRTScps/bin/vxcperv
```

If the command is successful, the command immediately returns without any message.

- 2 Verify the log file `/var/VRTScps/log/cpserver_A.log` to confirm the state of the CP server.

To stop CP server outside VCS control

- 1 Run the following command:

```
# cpsadm -s cp_server -a halt_cps
```

The variable `cp_server` represents the CP server's virtual IP address or virtual host name and `port_number` represents the port number on which the CP server is listening.

- 2 Verify the log file `/var/VRTScps/log/cpserver_A.log` to confirm that the CP server received the halt message and has shut down.

Checking the connectivity of CP servers

To check the connectivity of a CP server

Type the following command:

```
# cpsadm -s cp_server -a ping_cps
```

Adding and removing virtual IP addresses and ports for CP servers at run-time

The procedure of adding and removing virtual IP addresses and ports for CP servers at run-time is only applicable for communication over Veritas Product Authentication Services (AT) and for non-secure communication. It does not apply for communication over HTTPS.

You can use more than one virtual IP address for coordination point server (CP server) communication. You can assign port numbers to each of the virtual IP addresses.

You can use the `cpsadm` command if you want to add or remove virtual IP addresses and ports after your initial CP server setup. However, these virtual IP addresses and ports that you add or remove does not change the `vxcps.conf` file. So, these changes do not persist across CP server restarts.

See the `cpsadm(1m)` manual page for more details.

To add and remove virtual IP addresses and ports for CP servers at run-time

- 1 To list all the ports that the CP server is configured to listen on, run the following command:

```
# cpsadm -s cp_server -a list_ports
```

If the CP server has not been able to successfully listen on a given port at least once, then the Connect History in the output shows never. If the IP addresses are down when the vxcperv process starts, vxcperv binds to the IP addresses when the addresses come up later. For example:

```
# cpsadm -s 127.0.0.1 -a list_ports
```

IP Address	Connect History
[10.209.79.60]:14250	once
[10.209.79.61]:56789	once
[10.209.78.252]:14250	never
[192.10.10.32]:14250	once

CP server does not actively monitor port health. If the CP server successfully listens on any IP:port at least once, then the Connect History for that IP:port shows once even if the port goes down later during CP server's lifetime. You can obtain the latest status of the IP address from the corresponding IP resource state that is configured under VCS.

- 2 To add a new port (IP:port) for the CP server without restarting the CP server, run the following command:

```
# cpsadm -s cp_server -a add_port  
-i ip_address -r port_number
```

For example:

```
# cpsadm -s 127.0.0.1 -a add_port -i 10.209.78.52 -r 14250  
Port [10.209.78.52]:14250 successfully added.
```

- 3 To stop the CP server from listening on a port (IP:port) without restarting the CP server, run the following command:

```
# cpsadm -s cp_server -a rm_port  
-i ip_address -r port_number
```

For example:

```
# cpsadm -s 10.209.78.52 -a rm_port -i 10.209.78.252  
No port specified. Assuming default port i.e 14250  
Port [10.209.78.252]:14250 successfully removed.
```

Taking a CP server database snapshot

To take a CP server database snapshot

Type the following command:

```
# cpsadm -s cp_server -a db_snapshot
```

The CP server database snapshot is stored at

`/etc/VRTScps/db/cpsdbsnap.DATE.TIME`

Where, *DATE* is the snapshot creation date, and *TIME* is the snapshot creation time.

Replacing coordination points for server-based fencing in an online cluster

Use the following procedure to perform a planned replacement of customized coordination points (CP servers or SCSI-3 disks) without incurring application downtime on an online VCS cluster.

Note: If multiple clusters share the same CP server, you must perform this replacement procedure in each cluster.

You can use the `vxfer` utility to replace coordination points when fencing is running in customized mode in an online cluster, with `vxfer_mechanism=cps`. The utility also supports migration from server-based fencing (`vxfer_mode=customized`) to disk-based fencing (`vxfer_mode=scsi3`) and vice versa in an online cluster.

However, if the VCS cluster has fencing disabled (`vxfer_mode=disabled`), then you must take the cluster offline to configure disk-based or server-based fencing.

See [“Deployment and migration scenarios for CP server”](#) on page 402.

You can cancel the coordination point replacement operation at any time using the `vxfenswap -a cancel` command.

See [“About the vxfenswap utility”](#) on page 376.

To replace coordination points for an online cluster

- 1 Ensure that the VCS cluster nodes and users have been added to the new CP server(s). Run the following commands:

```
# cpsadm -s cpserver -a list_nodes
# cpsadm -s cpserver -a list_users
```

If the VCS cluster nodes are not present here, prepare the new CP server(s) for use by the VCS cluster.

See the *Cluster Server Installation Guide* for instructions.

- 2 Ensure that fencing is running on the cluster using the old set of coordination points and in customized mode.

For example, enter the following command:

```
# vxfenadm -d
```

The command returns:

```
I/O Fencing Cluster Information:
=====
Fencing Protocol Version: <version>
Fencing Mode: Customized
Cluster Members:
* 0 (sys1)
  1 (sys2)
RFSM State Information:
node 0 in state 8 (running)
node 1 in state 8 (running)
```

- 3 Create a new `/etc/vxfenmode.test` file on each VCS cluster node with the fencing configuration changes such as the CP server information.

Review and if necessary, update the `vxfenmode` parameters for security, the coordination points, and if applicable to your configuration, `vxfendg`.

Refer to the text information within the `vxfenmode` file for additional information about these parameters and their new possible values.

- 4 From one of the nodes of the cluster, run the `vxfenswap` utility.

The `vxfenswap` utility requires secure ssh connection to all the cluster nodes. Use `-n` to use rsh instead of default ssh. Use `-p <protocol>`, where `<protocol>` can be ssh, rsh, or hacli.

```
# vxfenswap [-n | -p <protocol>]
```

- 5 Review the message that the utility displays and confirm whether you want to commit the change.

- If you do not want to commit the new fencing configuration changes, press Enter or answer n at the prompt.

```
Do you wish to commit this change? [y/n] (default: n) n
```

The `vxfenswap` utility rolls back the migration operation.

- If you want to commit the new fencing configuration changes, answer y at the prompt.

```
Do you wish to commit this change? [y/n] (default: n) y
```

If the utility successfully completes the operation, the utility moves the `/etc/vxfenmode.test` file to the `/etc/vxfenmode` file.

- 6 Confirm the successful execution of the `vxfenswap` utility by checking the coordination points currently used by the `vxfen` driver.

For example, run the following command:

```
# vxfenconfig -l
```

Refreshing registration keys on the coordination points for server-based fencing

Replacing keys on a coordination point (CP server) when the VCS cluster is online involves refreshing that coordination point's registrations. You can perform a planned refresh of registrations on a CP server without incurring application downtime on the VCS cluster. You must refresh registrations on a CP server if the CP server agent issues an alert on the loss of such registrations on the CP server database.

The following procedure describes how to refresh the coordination point registrations.

To refresh the registration keys on the coordination points for server-based fencing

- 1** Ensure that the VCS cluster nodes and users have been added to the new CP server(s). Run the following commands:

```
# cpsadm -s cp_server -a list_nodes
# cpsadm -s cp_server -a list_users
```

If the VCS cluster nodes are not present here, prepare the new CP server(s) for use by the VCS cluster.

See the *Cluster Server Installation Guide* for instructions.

- 2** Ensure that fencing is running on the cluster in customized mode using the coordination points mentioned in the `/etc/vxfenmode` file.

If the `/etc/vxfenmode.test` file exists, ensure that the information in it and the `/etc/vxfenmode` file are the same. Otherwise, `vxfenswap` utility uses information listed in `/etc/vxfenmode.test` file.

For example, enter the following command:

```
# vxfenadm -d

=====
Fencing Protocol Version: 201
Fencing Mode: CUSTOMIZED
Cluster Members:
* 0 (sys1)
  1 (sys2)
RFSM State Information:
node 0 in state 8 (running)
node 1 in state 8 (running)
```

- 3** List the coordination points currently used by I/O fencing :

```
# vxfenconfig -l
```

- 4** Copy the `/etc/vxfenmode` file to the `/etc/vxfenmode.test` file.

This ensures that the configuration details of both the files are the same.

- 5 Run the `vx fenceswap` utility from one of the nodes of the cluster.

The `vx fenceswap` utility requires secure ssh connection to all the cluster nodes. Use `-n` to use rsh instead of default ssh.

For example:

```
# vx fenceswap [-n]
```

The command returns:

```
VERITAS vx fenceswap version <version> <platform>
The logfile generated for vx fenceswap is
/var/VRTSvcs/log/vxfen/vx fenceswap.log.
19156
Please Wait...
VXFEN vx fenconfig NOTICE Driver will use customized fencing
- mechanism cps
Validation of coordination points change has succeeded on
all nodes.
You may commit the changes now.
WARNING: This may cause the whole cluster to panic
if a node leaves membership before the change is complete.
```

- 6 You are then prompted to commit the change. Enter **y** for yes.

The command returns a confirmation of successful coordination point replacement.

- 7 Confirm the successful execution of the `vx fenceswap` utility. If CP agent is configured, it should report ONLINE as it succeeds to find the registrations on coordination points. The registrations on the CP server and coordinator disks can be viewed using the `cpsadm` and `vx fenadm` utilities respectively.

Note that a running online coordination point refreshment operation can be canceled at any time using the command:

```
# vx fenceswap -a cancel
```

Deployment and migration scenarios for CP server

[Table 10-3](#) describes the supported deployment and migration scenarios, and the procedures you must perform on the VCS cluster and the CP server.

Table 10-3 CP server deployment and migration scenarios

Scenario	CP server	VCS cluster	Action required
Setup of CP server for a VCS cluster for the first time	New CP server	New VCS cluster using CP server as coordination point	<p>On the designated CP server, perform the following tasks:</p> <ol style="list-style-type: none"> 1 Prepare to configure the new CP server. 2 Configure the new CP server. 3 Prepare the new CP server for use by the VCS cluster. <p>On the VCS cluster nodes, configure server-based I/O fencing.</p> <p>See the <i>Cluster Server Installation Guide</i> for the procedures.</p>
Add a new VCS cluster to an existing and operational CP server	Existing and operational CP server	New VCS cluster	<p>On the VCS cluster nodes, configure server-based I/O fencing.</p> <p>See the <i>Cluster Server Installation Guide</i> for the procedures.</p>
Replace the coordination point from an existing CP server to a new CP server	New CP server	Existing VCS cluster using CP server as coordination point	<p>On the designated CP server, perform the following tasks:</p> <ol style="list-style-type: none"> 1 Prepare to configure the new CP server. 2 Configure the new CP server. 3 Prepare the new CP server for use by the VCS cluster. <p>See the <i>Cluster Server Installation Guide</i> for the procedures.</p> <p>On a node in the VCS cluster, run the <code>vx fenceswap</code> command to move to replace the CP server:</p> <p>See “Replacing coordination points for server-based fencing in an online cluster” on page 398.</p>
Replace the coordination point from an existing CP server to an operational CP server coordination point	Operational CP server	Existing VCS cluster using CP server as coordination point	<p>On the designated CP server, prepare to configure the new CP server manually.</p> <p>See the <i>Cluster Server Installation Guide</i> for the procedures.</p> <p>On a node in the VCS cluster, run the <code>vx fenceswap</code> command to move to replace the CP server:</p> <p>See “Replacing coordination points for server-based fencing in an online cluster” on page 398.</p>

Table 10-3 CP server deployment and migration scenarios (*continued*)

Scenario	CP server	VCS cluster	Action required
Enabling fencing in a VCS cluster with a new CP server coordination point	New CP server	Existing VCS cluster with fencing configured in disabled mode	<p>Note: Migrating from fencing in disabled mode to customized mode incurs application downtime on the VCS cluster.</p> <p>On the designated CP server, perform the following tasks:</p> <ol style="list-style-type: none"> 1 Prepare to configure the new CP server. 2 Configure the new CP server 3 Prepare the new CP server for use by the VCS cluster <p>See the <i>Cluster Server Installation Guide</i> for the procedures.</p> <p>On the VCS cluster nodes, perform the following:</p> <ol style="list-style-type: none"> 1 Stop all applications, VCS, and fencing on the VCS cluster. 2 To stop VCS, use the following command (to be run on all the VCS cluster nodes): <pre># hstop -local</pre> 3 Stop fencing using the following command: <pre># /etc/init.d/vxfen.rc stop</pre> 4 Reconfigure I/O fencing on the VCS cluster. <p>See the <i>Cluster Server Installation Guide</i> for the procedures.</p>

Table 10-3 CP server deployment and migration scenarios (*continued*)

Scenario	CP server	VCS cluster	Action required
Enabling fencing in a VCS cluster with an operational CP server coordination point	Operational CP server	Existing VCS cluster with fencing configured in disabled mode	<p>Note: Migrating from fencing in disabled mode to customized mode incurs application downtime.</p> <p>On the designated CP server, prepare to configure the new CP server.</p> <p>See the <i>Cluster Server Installation Guide</i> for this procedure.</p> <p>On the VCS cluster nodes, perform the following tasks:</p> <ol style="list-style-type: none"> 1 Stop all applications, VCS, and fencing on the VCS cluster. 2 To stop VCS, use the following command (to be run on all the VCS cluster nodes): <pre># hastop -local</pre> 3 Stop fencing using the following command: <pre># /etc/init.d/vxfen.rc stop</pre> 4 Reconfigure fencing on the VCS cluster. <p>See the <i>Cluster Server Installation Guide</i> for the procedures.</p>

Table 10-3 CP server deployment and migration scenarios (*continued*)

Scenario	CP server	VCS cluster	Action required
Enabling fencing in a VCS cluster with a new CP server coordination point	New CP server	Existing VCS cluster with fencing configured in scsi3 mode	<p>On the designated CP server, perform the following tasks:</p> <ol style="list-style-type: none"> 1 Prepare to configure the new CP server. 2 Configure the new CP server 3 Prepare the new CP server for use by the VCS cluster <p>See the <i>Cluster Server Installation Guide</i> for the procedures.</p> <p>Based on whether the cluster is online or offline, perform the following procedures:</p> <p>For a cluster that is online, perform the following task on the VCS cluster:</p> <ul style="list-style-type: none"> ◆ Run the <code>vx fenceswap</code> command to migrate from disk-based fencing to the server-based fencing. <p>See "Migrating from disk-based to server-based fencing in an online cluster" on page 408.</p> <p>For a cluster that is offline, perform the following tasks on the VCS cluster:</p> <ol style="list-style-type: none"> 1 Stop all applications, VCS, and fencing on the VCS cluster. 2 To stop VCS, use the following command (to be run on all the VCS cluster nodes): <ul style="list-style-type: none"> # <code>hastop -local</code> 3 Stop fencing using the following command: <ul style="list-style-type: none"> # <code>/etc/init.d/vxfen.rc stop</code> 4 Reconfigure I/O fencing on the VCS cluster. <p>See the <i>Cluster Server Installation Guide</i> for the procedures.</p>

Table 10-3 CP server deployment and migration scenarios (*continued*)

Scenario	CP server	VCS cluster	Action required
Enabling fencing in a VCS cluster with an operational CP server coordination point	Operational CP server	Existing VCS cluster with fencing configured in disabled mode	<p>On the designated CP server, prepare to configure the new CP server.</p> <p>See the <i>Cluster Server Installation Guide</i> for this procedure.</p> <p>Based on whether the cluster is online or offline, perform the following procedures:</p> <p>For a cluster that is online, perform the following task on the VCS cluster:</p> <ul style="list-style-type: none"> ◆ Run the <code>vx fenceswap</code> command to migrate from disk-based fencing to the server-based fencing. <p>See “Migrating from disk-based to server-based fencing in an online cluster” on page 408.</p> <p>For a cluster that is offline, perform the following tasks on the VCS cluster:</p> <ol style="list-style-type: none"> 1 Stop all applications, VCS, and fencing on the VCS cluster. 2 To stop VCS, use the following command (to be run on all the VCS cluster nodes): <pre># hstop -local</pre> 3 Stop fencing using the following command: <pre># /etc/init.d/vxfen.rc stop</pre> 4 Reconfigure fencing on the VCS cluster. <p>See the <i>Cluster Server Installation Guide</i> for the procedures.</p>
Refreshing registrations of VCS cluster nodes on coordination points (CP servers/coordinator disks) without incurring application downtime	Operational CP server	Existing VCS cluster using the CP server as coordination point	<p>On the VCS cluster run the <code>vx fenceswap</code> command to refresh the keys on the CP server:</p> <p>See “Refreshing registration keys on the coordination points for server-based fencing” on page 400.</p>

About migrating between disk-based and server-based fencing configurations

You can migrate between fencing configurations without incurring application downtime in the VCS clusters.

You can migrate from disk-based fencing to server-based fencing in the following cases:

- You want to leverage the benefits of server-based fencing.
- You want to replace faulty coordinator disks with coordination point servers (CP servers).

See [“Migrating from disk-based to server-based fencing in an online cluster”](#) on page 408.

Similarly, you can migrate from server-based fencing to disk-based fencing when you want to perform maintenance tasks on the CP server systems.

See [“Migrating from server-based to disk-based fencing in an online cluster”](#) on page 409.

Migrating from disk-based to server-based fencing in an online cluster

You can either use the installer or manually migrate from disk-based fencing to server-based fencing without incurring application downtime in the VCS clusters.

See [“About migrating between disk-based and server-based fencing configurations”](#) on page 408.

You can also use response files to migrate between fencing configurations.

See [“Migrating between fencing configurations using response files”](#) on page 409.

Warning: The cluster might panic if any node leaves the cluster membership before the coordination points migration operation completes.

This section covers the following procedures:

Migrating using the
script-based installer

Migrating manually

Migrating from server-based to disk-based fencing in an online cluster

You can either use the installer or manually migrate from server-based fencing to disk-based fencing without incurring application downtime in the VCS clusters.

See [“About migrating between disk-based and server-based fencing configurations”](#) on page 408.

You can also use response files to migrate between fencing configurations.

See [“Migrating between fencing configurations using response files”](#) on page 409.

Warning: The cluster might panic if any node leaves the cluster membership before the coordination points migration operation completes.

This section covers the following procedures:

Migrating using the
script-based installer

Migrating manually

Migrating between fencing configurations using response files

Typically, you can use the response file that the installer generates after you migrate between I/O fencing configurations. Edit these response files to perform an automated fencing reconfiguration in the VCS cluster.

To configure I/O fencing using response files

- 1 Make sure that VCS is configured.
- 2 Make sure system-to-system communication is functioning properly.

- 3 Make sure that the VCS cluster is online and uses either disk-based or server-based fencing.

```
# vxxfenadm -d
```

For example, if VCS cluster uses disk-based fencing:

```
I/O Fencing Cluster Information:
=====
Fencing Protocol Version: 201
Fencing Mode: SCSI3
Fencing SCSI3 Disk Policy: dmp
Cluster Members:
  * 0 (sys1)
  1 (sys2)
RFSM State Information:
  node 0 in state 8 (running)
  node 1 in state 8 (running)
```

For example, if the VCS cluster uses server-based fencing:

```
I/O Fencing Cluster Information:
=====
Fencing Protocol Version: 201
Fencing Mode: Customized
Fencing Mechanism: cps
Cluster Members:
  * 0 (sys1)
  1 (sys2)
RFSM State Information:
  node 0 in state 8 (running)
  node 1 in state 8 (running)
```

About migrating between disk-based and server-based fencing configurations

- 4 Copy the response file to one of the cluster systems where you want to configure I/O fencing.

Review the sample files to reconfigure I/O fencing.

See [“Sample response file to migrate from disk-based to server-based fencing”](#) on page 411.

See [“Sample response file to migrate from server-based fencing to disk-based fencing”](#) on page 412.

See [“Sample response file to migrate from single CP server-based fencing to server-based fencing”](#) on page 412.

- 5 Edit the values of the response file variables as necessary.

See [“Response file variables to migrate between fencing configurations”](#) on page 412.

- 6 Start the I/O fencing reconfiguration from the system to which you copied the response file. For example:

```
# /opt/VRTS/install/installer<version> -responsefile /tmp/
\ response_file
```

Where *<version>* is the specific release version, and */tmp/response_file* is the response file's full path name.

Sample response file to migrate from disk-based to server-based fencing

The following is a sample response file to migrate from disk-based fencing with three coordinator disks to server-based fencing with one CP server and two coordinator disks:

```
$CFG{disks_to_remove}=[ qw(emc_clariion0_62) ];
$CFG{fencing_cps}=[ qw(10.198.89.251) ];
$CFG{fencing_cps_ports}{ "10.198.89.204" }=14250;
$CFG{fencing_cps_ports}{ "10.198.89.251" }=14250;
$CFG{fencing_cps_vips}{ "10.198.89.251" }=[ qw(10.198.89.251 10.198.89.204) ];
$CFG{fencing_ncp}=1;
$CFG{fencing_option}=4;
$CFG{opt}{configure}=1;
$CFG{opt}{fencing}=1;
$CFG{prod}="VCS60";
$CFG{systems}=[ qw(sys1 sys2) ];
$CFG{vcs_clusterid}=22462;
$CFG{vcs_clustname}="clus1";
```

Sample response file to migrate from server-based fencing to disk-based fencing

The following is a sample response file to migrate from server-based fencing with one CP server and two coordinator disks to disk-based fencing with three coordinator disks:

```
$CFG{fencing_disks}=[ qw(emc_clariion0_66) ];
$CFG{fencing_mode}="scsi3";
$CFG{fencing_ncp}=1;
$CFG{fencing_ndisks}=1;
$CFG{fencing_option}=4;
$CFG{opt}{configure}=1;
$CFG{opt}{fencing}=1;
$CFG{prod}="VCS60";
$CFG{servers_to_remove}=[ qw([10.198.89.251]:14250) ];
$CFG{systems}=[ qw(sys1 sys2) ];
$CFG{vcs_clusterid}=42076;
$CFG{vcs_clustername}="clus1";
```

Sample response file to migrate from single CP server-based fencing to server-based fencing

The following is a sample response file to migrate from single CP server-based fencing to server-based fencing with one CP server and two coordinator disks:

```
$CFG{fencing_disks}=[ qw(emc_clariion0_62 emc_clariion0_65) ];
$CFG{fencing_dgname}="fendg";
$CFG{fencing_scsi3_disk_policy}="dmp";
$CFG{fencing_ncp}=2;
$CFG{fencing_ndisks}=2;
$CFG{fencing_option}=4;
$CFG{opt}{configure}=1;
$CFG{opt}{fencing}=1;
$CFG{prod}="VCS60";
$CFG{systems}=[ qw(sys1 sys2) ];
$CFG{vcs_clusterid}=42076;
$CFG{vcs_clustername}="clus1";
```

Response file variables to migrate between fencing configurations

[Table 10-4](#) lists the response file variables that specify the required information to migrate between fencing configurations for VCS.

Table 10-4 Response file variables specific to migrate between fencing configurations

Variable	List or Scalar	Description
CFG {fencing_option}	Scalar	<p>Specifies the I/O fencing configuration mode.</p> <ul style="list-style-type: none"> ■ 1—Coordination Point Server-based I/O fencing ■ 2—Coordinator disk-based I/O fencing ■ 3—Disabled mode ■ 4—Fencing migration when the cluster is online <p>(Required)</p>
CFG {fencing_reusedisk}	Scalar	<p>If you migrate to disk-based fencing or to server-based fencing that uses coordinator disks, specifies whether to use free disks or disks that already belong to a disk group.</p> <ul style="list-style-type: none"> ■ 0—Use free disks as coordinator disks ■ 1—Use disks that already belong to a disk group as coordinator disks (before configuring these as coordinator disks, installer removes the disks from the disk group that the disks belonged to.) <p>(Required if your fencing configuration uses coordinator disks)</p>
CFG {fencing_ncp}	Scalar	<p>Specifies the number of new coordination points to be added.</p> <p>(Required)</p>
CFG {fencing_ndisks}	Scalar	<p>Specifies the number of disks in the coordination points to be added.</p> <p>(Required if your fencing configuration uses coordinator disks)</p>

Table 10-4 Response file variables specific to migrate between fencing configurations *(continued)*

Variable	List or Scalar	Description
CFG {fencing_disks}	List	Specifies the disks in the coordination points to be added. (Required if your fencing configuration uses coordinator disks)
CFG {fencing_dgname}	Scalar	Specifies the disk group that the coordinator disks are in. (Required if your fencing configuration uses coordinator disks)
CFG {fencing_scsi3_disk_policy}	Scalar	Specifies the disk policy that the disks must use. (Required if your fencing configuration uses coordinator disks)
CFG {fencing_cps}	List	Specifies the CP servers in the coordination points to be added. (Required for server-based fencing)
CFG {fencing_cps_vips}{\$vip1}	List	Specifies the virtual IP addresses or the fully qualified host names of the new CP server. (Required for server-based fencing)
CFG {fencing_cps_ports}{\$vip}	Scalar	Specifies the port that the virtual IP of the new CP server must listen on. If you do not specify, the default value is 14250. (Optional)
CFG {servers_to_remove}	List	Specifies the CP servers in the coordination points to be removed.
CFG {disks_to_remove}	List	Specifies the disks in the coordination points to be removed
CFG{donotreconfigurevcs}	Scalar	Defines if you need to re-configure VCS. (Optional)

Table 10-4 Response file variables specific to migrate between fencing configurations (*continued*)

Variable	List or Scalar	Description
CFG{donotreconfigurefencing}	Scalar	defines if you need to re-configure fencing. (Optional)

Enabling or disabling the preferred fencing policy

You can enable or disable the preferred fencing feature for your I/O fencing configuration.

You can enable preferred fencing to use system-based race policy, group-based race policy, or site-based policy. If you disable preferred fencing, the I/O fencing configuration uses the default count-based race policy.

Preferred fencing is not applicable to majority-based I/O fencing.

See [“About preferred fencing”](#) on page 319.

See [“How preferred fencing works”](#) on page 323.

To enable preferred fencing for the I/O fencing configuration

- 1 Make sure that the cluster is running with I/O fencing set up.

```
# vxfsadm -d
```

- 2 Make sure that the cluster-level attribute UseFence has the value set to SCSI3.

```
# haclus -value UseFence
```

- 3 To enable system-based race policy, perform the following steps:

- Make the VCS configuration writable.

```
# haconf -makerw
```

- Set the value of the cluster-level attribute PreferredFencingPolicy as System.

```
# haclus -modify PreferredFencingPolicy System
```

- Set the value of the system-level attribute FencingWeight for each node in the cluster.

For example, in a two-node cluster, where you want to assign sys1 five times more weight compared to sys2, run the following commands:

```
# hasys -modify sys1 FencingWeight 50
# hasys -modify sys2 FencingWeight 10
```

- Save the VCS configuration.

```
# haconf -dump -makero
```

- Verify fencing node weights using:

```
# vxfenconfig -a
```

4 To enable group-based race policy, perform the following steps:

- Make the VCS configuration writable.

```
# haconf -makerw
```

- Set the value of the cluster-level attribute PreferredFencingPolicy as Group.

```
# haclus -modify PreferredFencingPolicy Group
```

- Set the value of the group-level attribute Priority for each service group. For example, run the following command:

```
# hagrps -modify service_group Priority 1
```

Make sure that you assign a parent service group an equal or lower priority than its child service group. In case the parent and the child service groups are hosted in different subclusters, then the subcluster that hosts the child service group gets higher preference.

- Save the VCS configuration.

```
# haconf -dump -makero
```

5 To enable site-based race policy, perform the following steps:

- Make the VCS configuration writable.

```
# haconf -makerw
```

- Set the value of the cluster-level attribute PreferredFencingPolicy as Site.

```
# haclus -modify PreferredFencingPolicy Site
```

- Set the value of the site-level attribute Preference for each site.

```
For example,  
# hasite -modify Pune Preference 2
```

- Save the VCS configuration.

```
# haconf -dump -makero
```

- 6 To view the fencing node weights that are currently set in the fencing driver, run the following command:

```
# vxfenconfig -a
```

To disable preferred fencing for the I/O fencing configuration

- 1 Make sure that the cluster is running with I/O fencing set up.

```
# vxfenadm -d
```

- 2 Make sure that the cluster-level attribute UseFence has the value set to SCSI3.

```
# haclus -value UseFence
```

- 3 To disable preferred fencing and use the default race policy, set the value of the cluster-level attribute PreferredFencingPolicy as Disabled.

```
# haconf -makerw  
# haclus -modify PreferredFencingPolicy Disabled  
# haconf -dump -makero
```

About I/O fencing log files

Refer to the appropriate log files for information related to a specific utility. The log file location for each utility or command is as follows:

- vxfen start and stop logs: `/var/VRTSvcs/log/vxfen/vxfen.log`
- vxfenclearpre utility: `/var/VRTSvcs/log/vxfen/vxfen.log`
- vxfenctl utility: `/var/VRTSvcs/log/vxfen/vxfenctl.log*`
- vxfenswap utility: `/var/VRTSvcs/log/vxfen/vxfenswap.log*`
- vxfentsthdw utility: `/var/VRTSvcs/log/vxfen/vxfentsthdw.log*`

The asterisk, *, represents a number that differs for each invocation of the command.

Controlling VCS behavior

This chapter includes the following topics:

- [VCS behavior on resource faults](#)
- [About controlling VCS behavior at the service group level](#)
- [About controlling VCS behavior at the resource level](#)
- [Changing agent file paths and binaries](#)
- [VCS behavior on loss of storage connectivity](#)
- [Service group workload management](#)
- [Sample configurations depicting workload management](#)

VCS behavior on resource faults

VCS considers a resource faulted in the following situations:

- When the resource state changes unexpectedly. For example, an online resource going offline.
- When a required state change does not occur. For example, a resource failing to go online or offline when commanded to do so.

In many situations, VCS agents take predefined actions to correct the issue before reporting resource failure to the engine. For example, the agent may try to bring a resource online several times before declaring a fault.

When a resource faults, VCS takes automated actions to clean up the faulted resource. The Clean function makes sure the resource is completely shut down before bringing it online on another node. This prevents concurrency violations.

When a resource faults, VCS takes all resources dependent on the faulted resource offline. The fault is thus propagated in the service group

Critical and non-critical resources

The Critical attribute for a resource defines whether a service group fails over when the resource faults. If a resource is configured as non-critical (by setting the Critical attribute to 0) and no resources depending on the failed resource are critical, the service group will not failover. VCS takes the failed resource offline and updates the group's status to PARTIAL. The attribute also determines whether a service group tries to come online on another node if, during the group's online process, a resource fails to come online.

In atleast resource dependency, criticality is overridden. If the minimum criteria of atleast resource dependency is met:

- Service group does not failover even if a critical resource faults.
- Fault is not propagated up in the dependency tree even if a non-critical resource faults.
- Service group remains in ONLINE state in spite of resource faults.

VCS behavior diagrams

Figure 11-1 displays the symbols used for resource configuration and color codes.

Figure 11-1 Symbols for resource configuration/actions and color codes

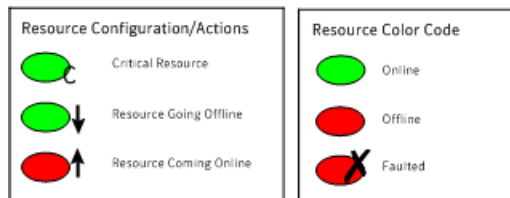

Example scenario 1: Resource with critical parent faults

Figure 11-2 shows an example of a service group with five resources, of which resource R1 is configured as a critical resource.

Figure 11-2 Scenario 1: Resource with critical parent faults

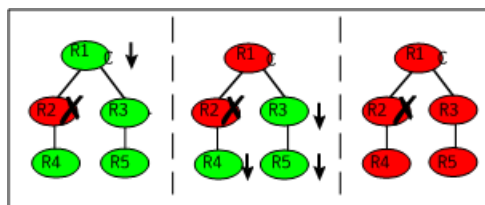

When resource R2 faults, the fault is propagated up the dependency tree to resource R1. When the critical resource R1 goes offline, VCS must fault the service group and fail it over elsewhere in the cluster. VCS takes other resources in the service group offline in the order of their dependencies. After taking resources R3, R4, and R5 offline, VCS fails over the service group to another node.

Example scenario 2: Resource with non-critical parent faults

Figure 11-3 shows an example of a service group that does not have any critical resources.

Figure 11-3 Scenario 2: Resource with non-critical parent faults

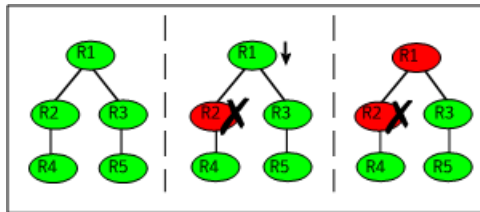

When resource R2 faults, the engine propagates the failure up the dependency tree. Neither resource R1 nor resource R2 are critical, so the fault does not result in the tree going offline or in service group failover.

Example scenario 3: Resource with critical parent fails to come online

Figure 11-4 shows an example where a command is issued to bring the service group online and resource R2 fails to come online.

Figure 11-4 Scenario 3: Resource with critical parent fails to come online

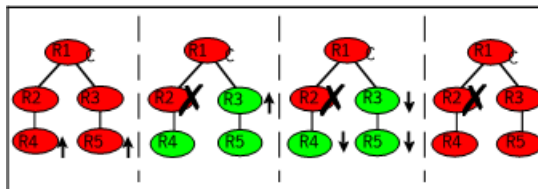

VCS calls the Clean function for resource R2 and propagates the fault up the dependency tree. Resource R1 is set to critical, so the service group is taken offline and failed over to another node in the cluster.

Example scenario 4: Resource with atleast resource dependency faults

Figure 11-5 shows an example where the parent resource (R1) depends on five child resources (R2, R3, R4, R5, and R6). Out of these five resources, at least two resources must be online for the parent resource to remain online.

Figure 11-5 Example scenario 4: Resource with atleast resource dependency faults

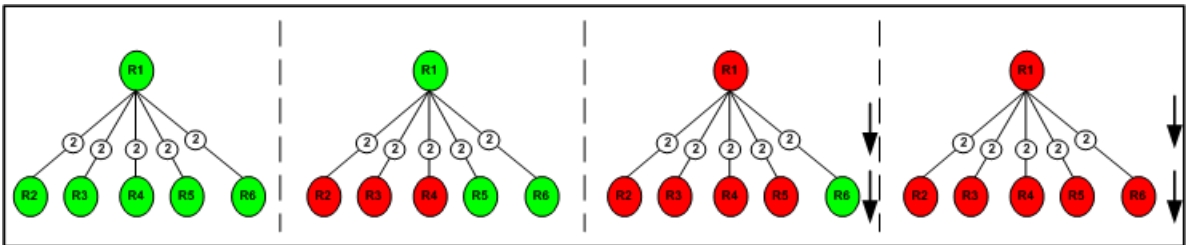

VCS tolerates the fault of R2, R3, and R4 as the minimum criteria of 2 is met. When R5 faults, only R6 is online and the number of online child resources goes below the minimum criteria of 2 and the fault is propagated up the dependency tree to the parent resource R1 and service group is taken offline.

About controlling VCS behavior at the service group level

You can configure service group attributes to modify VCS behavior in response to resource faults.

About the AutoRestart attribute

If a persistent resource on a service group (GROUP_1) faults, VCS fails the service group over to another system if the following conditions are met:

- The AutoFailOver attribute is set.
- Another system in the cluster exists to which GROUP_1 can fail over.

If neither of these conditions is met, GROUP_1 remains offline and faulted, even after the faulted resource becomes online.

Setting the AutoRestart attribute enables a service group to be brought back online without manual intervention. If no failover targets are available, setting the AutoRestart attribute enables VCS to bring the group back online on the first available system after the group's faulted resource came online on that system.

For example, NIC is a persistent resource. In some cases, when a system boots and VCS starts, VCS probes all resources on the system. When VCS probes the NIC resource, the resource may not be online because the networking is not up and fully operational. In such situations, VCS marks the NIC resource as faulted, and does not bring the service group online. However, when the NIC resource becomes online and if AutoRestart is enabled, the service group is brought online.

About controlling failover on service group or system faults

The AutoFailOver attribute configures service group behavior in response to service group and system faults.

The possible values include 0, 1, and 2. You can set the value of this attribute as 2 if you have enabled the HA/DR license and if the service group is a non-hybrid service group.

[Table 11-1](#) shows the possible values for the attribute AutoFailover.

Table 11-1 Possible values of the AutoFailover attribute and their description

AutoFailover attribute value	Description
0	<p>VCS does not fail over the service group when a system or service group faults.</p> <p>If a fault occurs in a service group, the group is taken offline, depending on whether any of its resources are configured as critical. If a system faults, the service group is not failed over to another system.</p>
1	<p>VCS automatically fails over the service group when a system or a service group faults, provided a suitable node exists for failover.</p> <p>The service group attributes SystemZones and FailOverPolicy impact the failover behavior of the service group. For global clusters, the failover decision is also based on the ClusterFailOverPolicy.</p> <p>See "Service group attributes" on page 789.</p>
2	<p>VCS automatically fails over the service group only if another suitable node exists in the same system zone or sites.</p> <p>If a suitable node does not exist in the same system zone or sites, VCS brings the service group offline, and generates an alert for administrator's intervention. You can manually bring the group online using the <code>hagrp -online</code> command.</p> <p>Note: If SystemZones attribute is not defined, the failover behavior is similar to AutoFailOver=1.</p>

About defining failover policies

The service group attribute `FailOverPolicy` governs how VCS calculates the target system for failover.

[Table 11-2](#) shows the possible values for the attribute `FailoverPolicy`.

Table 11-2 Possible values of the `FailOverPolicy` attribute and their description

FailOverPolicy attribute value	Description
Priority	<p>VCS selects the system with the lowest priority as the failover target. The Priority failover policy is ideal for simple two-node clusters or small clusters with few service groups.</p> <p>Priority is set in the <code>SystemList</code> attribute implicitly by ordering, such as <code>SystemList = {SystemA, SystemB}</code> or explicitly, such as <code>SystemList = {SystemA=0, SystemB=1}</code>. Priority is the default behavior.</p>
RoundRobin	<p>VCS selects the system running the fewest service groups as the failover target. This policy is ideal for large clusters running many service groups with similar server load characteristics (for example, similar databases or applications)</p>
Load	<p>The Load failover policy comprises the following components:</p> <p>System capacity and service group load, represented by the attributes <code>Capacity</code> and <code>Load</code> respectively.</p> <p>See System capacity and service group load on page 455.</p> <p>System limits and service group prerequisites, represented by the attributes <code>Limits</code> and <code>Prerequisites</code>, respectively.</p> <p>You cannot set the service group attribute <code>FailOverPolicy</code> to <code>Load</code> if the cluster attribute <code>Statistics</code> is enabled.</p> <p>See System limits and service group prerequisites on page 457.</p>

Table 11-2 Possible values of the FailOverPolicy attribute and their description (*continued*)

FailOverPolicy attribute value	Description
BiggestAvailable	<p>VCS selects a system based on the forecasted available capacity for all systems in the SystemList. The system with the highest forecasted available capacity is selected.</p> <p>This policy can be set only if the cluster attribute Statistics is set to Enabled. The service group attribute Load is defined in terms of CPU, Memory, and Swap in absolute units. The unit can be of the following values:</p> <ul style="list-style-type: none"> ■ CPU, MHz, or GHz for CPU ■ GB or MB for Memory ■ GB or MB for Swap <p>See “Cluster attributes” on page 831.</p>

About AdaptiveHA

AdaptiveHA enables VCS to dynamically select the biggest available target system to fail over an application when you set the service group attribute FailOverPolicy to BiggestAvailable. VCS monitors and forecasts the available capacity of systems in terms of CPU, memory, and swap to select the biggest available system.

Enabling AdaptiveHA for a service group

AdaptiveHA enables VCS to make dynamic decisions about failing over an application to the biggest available system.

To enable AdaptiveHA for a service group

- 1 Ensure cluster attribute Statistics is set to Enabled. You can check by using the following command,

```
# haclus -display|grep Statistics
```

You cannot edit this value at run time.
- 2 Set the Load of the service group in terms of CPU, Memory, or Swap in absolute units. The unit can be of any following values:
 - CPU, MHz, or GHz for CPU
 - GB or MB for Memory
 - GB or MB for Swap

Define at least one key for the Load attribute.

- 3 Check the default value of the MeterWeight attribute at the cluster level. If the attribute does not meet the service group's meter weight requirement, then set the MeterWeight at the service group level.
- 4 Set or edit the values for the following service group attributes in main.cf:
 - Modify the values of Load and MeterWeight as decided in the preceding steps.
 - Set the value of FailOverPolicy to BiggestAvailable.
 You can set or edit the service group level attributes Load, MeterWeight, and FailOverPolicy during run time.

After you complete the above steps, AdaptiveHA is enabled. The service group follows the BiggestAvailable policy during a failover.

The following table provides information on various attributes and the values they can take to enable AdaptiveHA:

Table 11-3

Use-case	Attribute values to be set
To turn on host metering	Set the cluster attribute Statistics to MeterHostOnly.
To turn off host metering	Set the cluster attribute Statistics to Disabled.
To turn on host metering and forecasting	Set the cluster attribute Statistics to Enabled.
To enable hagrpf -forecast CLI option	Set the cluster attribute Statistics to Enabled and also set the service group attribute Load based on your application's CPU, Mem or Swap usage.
To check the meters supported for any host or cluster node	Verify the value of cluster attribute HostAvailableMeters.
To enable host metering, forecast, and policy decisions using forecast	Perform the following actions: <ul style="list-style-type: none"> ■ Set the cluster attribute Statistics to Enabled ■ Set the service group attribute FailOverPolicy to BiggestAvailable. ■ Set service group attribute Load based on your application's CPU, Mem or Swap usage. ■ Optionally, set the service group attribute MeterWeight.

Table 11-3 (continued)

Use-case	Attribute values to be set
To change metering or forecast frequency	Set the MeterInterval and ForecastCycle keys in the cluster attribute MeterControl accordingly.
To check the available capacity and its forecast	Use the following commands to check values for available capacity and its forecast: <ul style="list-style-type: none"> ■ # hasys -value <i>system_name</i> AvailableCapacity ■ # hasys -value <i>system_name</i> HostAvailableForecast
To check if the metering and forecast is up-to-date	The metering value is up-to-date when the difference between GlobalCounter and AvailableGC is less than or equal to 24. The forecasting value is up-to-date when the difference between GlobalCounter and AvailableGC is less than or equal to 72.

See [“Cluster attributes”](#) on page 831.

See [“Service group attributes”](#) on page 789.

See [System attributes](#) on page 816.

Considerations for setting FailOverPolicy to BiggestAvailable

Parent or child service group linked with local dependency, and FailOverPolicy set to BiggestAvailable should have the same MeterWeight values. If the MeterWeight is not same for these groups, then the engine refers to the cluster attribute MeterWeight.

Note: The MeterWeight settings enable VCS to decide the target system for a child service group based on the preferred system for the parent service group.

See [“Enabling AdaptiveHA for a service group”](#) on page 424.

Limitations on AdaptiveHA

When the cluster attribute Statistics is not “disabled”, then VCS meters the real memory that is assigned and available on the system. By default, memory metering is enabled.

If AIX advanced features like AME (Active Memory Expansion) or AMS (Active Memory Sharing) are enabled, the metered values may differ from the actual values available for the application. The metering of memory on AIX is not supported due to these advanced memory features. Ensure that the “Mem” key is removed from the cluster attribute HostMeters. Also, if the FailOverPolicy is set to BiggestAvailable then the “Mem” key must be removed from the service group attributes Load and MeterWeight.

Manually upgrading the VCS configuration file to the latest version

The VCS configuration file (main.cf) gets automatically upgraded when you upgrade from older versions of VCS using the installer.

If you chose to upgrade VCS manually, ensure that you update the VCS configuration file to include the following changes:

- The Capacity attribute of system and Load attribute of service group are changed from scalar integer to integer-association (multidimensional) type attributes. For example, if the System has Capacity attribute defined and service group has Load attribute set in the main.cf file as:

```
Group Gx (
    ....
    Load = { Units = 20 }
)
System N1 (
    ....
    Capacity = 30
)
```

To update the main.cf file, update the Capacity values for Load and System attributes as follows:

```
Group Gx (
    ....
    Load = { Units = 20 }
)
System N1 (
    ....
```

```
Capacity = { Units = 30 }  
)
```

- If the cluster attribute HostMonLogLvl is defined in the main.cf file, then replace it with Statistics and make the appropriate change from the following:
 - Replace HostMonLogLvl = ALL with Statistics = MeterHostOnly.
 - Replace HostMonLogLvl = AgentOnly with Statistics = MeterHostOnly.

Note: For HostMonLogLvl value of AgentOnly, no exact equivalent value for Statistics exists. However, when you set Statistics to MeterHostOnly, VCS logs host utilization messages in the engine logs and in the HostMonitor agent logs.

- Replace HostMonLogLvl = Disabled with Statistics = Disabled.

See [“About the main.cf file”](#) on page 63.

About system zones

The SystemZones attribute enables you to create a subset of systems to use in an initial failover decision. This feature allows fine-tuning of application failover decisions, and yet retains the flexibility to fail over anywhere in the cluster.

If the attribute is configured, a service group tries to stay within its zone before choosing a host in another zone. For example, in a three-tier application infrastructure with Web, application, and database servers, you could create two system zones: one each for the application and the database. In the event of a failover, a service group in the application zone will try to fail over to another node within the zone. If no nodes are available in the application zone, the group will fail over to the database zone, based on the configured load and limits.

In this configuration, excess capacity and limits on the database backend are kept in reserve to handle the larger load of a database failover. The application servers handle the load of service groups in the application zone. During a cascading failure, the excess capacity in the cluster is available to all service groups.

About sites

The SiteAware attribute enables you to create sites to use in an initial failover decision in campus clusters. A service group can failover to another site even though a failover target is available within the same site. If the SiteAware attribute is set to 1, you cannot configure SystemZones. You can define site dependencies to restrict

dependent applications to fail over within the same site. If the SiteAware attribute is configured and set to 2, then the service group will failover within the same site.

For example, in a campus cluster with two sites, siteA and siteB, you can define a site dependency among service groups in a three-tier application infrastructure. The infrastructure consists of Web, application, and database to restrict the service group failover within same site.

See “[How VCS campus clusters work](#)” on page 639.

Load-based autostart

VCS provides a method to determine where a service group comes online when the cluster starts. Setting the AutoStartPolicy to Load instructs the VCS engine, HAD, to determine the best system on which to start the groups. VCS places service groups in an AutoStart queue for load-based startup as soon as the groups probe all running systems. VCS creates a subset of systems that meet all prerequisites and then chooses the system with the highest AvailableCapacity.

Set AutoStartPolicy = Load and configure the SystemZones attribute to establish a list of preferred systems on which to initially run a group.

About freezing service groups

Freezing a service group prevents VCS from taking any action when the service group or a system faults. Freezing a service group prevents dependent resources from going offline when a resource faults. It also prevents the Clean function from being called on a resource fault.

You can freeze a service group when performing operations on its resources from outside VCS control. This prevents VCS from taking actions on resources while your operations are on. For example, freeze a database group when using database controls to stop and start a database.

About controlling Clean behavior on resource faults

The ManageFaults attribute specifies whether VCS calls the Clean function when a resource faults. ManageFaults can be configured at both resource level and service group level. The values of this attribute at the resource level supersede those at the service group level.

You can configure the ManageFaults attribute with the following possible values:

- If the ManageFaults attribute is set to ALL, VCS calls the Clean function when a resource faults.

- If the ManageFaults attribute is set to NONE, VCS takes no action on a resource fault; it "hangs the service group until administrative action can be taken. VCS marks the resource state as ADMIN_WAIT and does not fail over the service group until the resource fault is removed and the ADMIN_WAIT state is cleared. VCS calls the resadminwait trigger when a resource enters the ADMIN_WAIT state due to a resource fault if the ManageFaults attribute is set to NONE. You can customize this trigger to provide notification about the fault.
 When ManageFaults is set to NONE and one of the following events occur, the resource enters the ADMIN_WAIT state:

Table 11-4 lists the possible events and the subsequent state of the resource when the ManageFaults attribute is set to NONE.

Table 11-4 Possible events when the ManageFaults attribute is set to NONE

Event	Resource state
The offline function did not complete within the expected time.	ONLINE ADMIN_WAIT
The offline function was ineffective.	ONLINE ADMIN_WAIT
The online function did not complete within the expected time.	OFFLINE ADMIN_WAIT
The online function was ineffective.	OFFLINE ADMIN_WAIT
The resource was taken offline unexpectedly.	ONLINE ADMIN_WAIT
For the online resource the monitor function consistently failed to complete within the expected time.	ONLINE MONITOR_TIMEDOUT ADMIN_WAIT

Clearing resources in the ADMIN_WAIT state

When VCS sets a resource in the ADMIN_WAIT state, it invokes the resadminwait trigger according to the reason the resource entered the state.

See [“About the resadminwait event trigger”](#) on page 522.

To clear a resource

- 1 Take the necessary actions outside VCS to bring all resources into the required state.
- 2 Verify that resources are in the required state by issuing the command:

```
hagrp -clearadminwait group -sys system
```

This command clears the ADMIN_WAIT state for all resources. If VCS continues to detect resources that are not in the required state, it resets the resources to the ADMIN_WAIT state.

- 3 If resources continue in the ADMIN_WAIT state, repeat step 1 and step 2, or issue the following command to stop VCS from setting the resource to the ADMIN_WAIT state:

```
hagrp -clearadminwait -fault group -sys system
```

This command has the following results:

- If the resadminwait trigger was called for the reasons 0 or 1, the resource state is set as ONLINE|UNABLE_TO_OFFLINE.
 - 0 = The offline function did not complete within the expected time.
 - 1 = The offline function was ineffective.
- If the resadminwait trigger was called for reasons 2, 3, or 4, the resource state is set as FAULTED. Note that when resources are set as FAULTED for these reasons, the clean function is not called. Verify that resources in ADMIN-WAIT are in clean, OFFLINE state prior to invoking this command.
 - 2 = The online function did not complete within the expected time.
 - 3 = The online function was ineffective.
 - 4 = The resource was taken offline unexpectedly.

When a service group has a resource in the ADMIN_WAIT state, the following service group operations cannot be performed on the resource: online, offline, switch, and flush. Also, you cannot use the hastop command when resources are in the ADMIN_WAIT state. When this occurs, you must issue the hastop command with -force option only.

About controlling fault propagation

The FaultPropagation attribute defines whether a resource fault is propagated up the resource dependency tree. It also defines whether a resource fault causes a service group failover.

You can configure the FaultPropagation attribute with the following possible values:

- If the FaultPropagation attribute is set to 1 (default), a resource fault is propagated up the dependency tree. If a resource in the path is critical, the service group is taken offline and failed over, provided the AutoFailOver attribute is set to 1.
- If the FaultPropagation is set to 0, resource faults are contained at the resource level. VCS does not take the dependency tree offline, thus preventing failover. If the resources in the service group remain online, the service group remains in the PARTIAL|FAULTED state. If all resources are offline or faulted, the service group remains in the OFFLINE| FAULTED state.

When a resource faults, VCS fires the resfault trigger and sends an SNMP trap. The trigger is called on the system where the resource faulted and includes the name of the faulted resource.

Customized behavior diagrams

This topic depicts how the ManageFaults and FaultPropagation attributes change VCS behavior when handling resource faults.

Figure 11-6 depicts the legends or resource color code.

Figure 11-6 Legends and resource color code

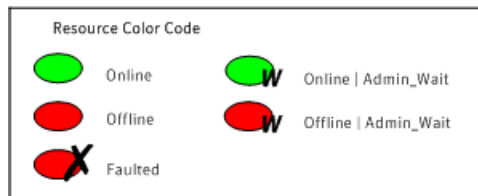

Example scenario: Resource with a critical parent and ManageFaults=NONE

Figure 11-7 shows an example of a service group that has five resources. The ManageFaults attribute for the group of resource R2 is set to NONE.

Figure 11-7 Scenario: Resource with a critical parent and ManageFaults=NONE

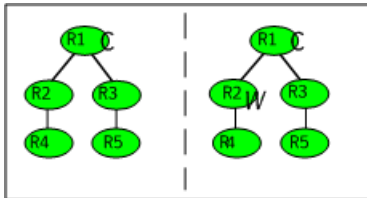

If resource R2 fails, the resource is marked as ONLINE|ADMIN_WAIT. The Clean function is not called for the resource. VCS does not take any other resource offline.

Example scenario: Resource with a critical parent and FaultPropagation=0

Figure 11-8 shows an example where the FaultPropagation attribute is set to 0.

Figure 11-8 Scenario: Resource with a critical parent and FaultPropagation=0

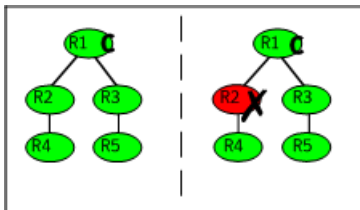

When resource R2 faults, the Clean function is called and the resource is marked as faulted. The fault is not propagated up the tree, and the group is not taken offline.

About preventing concurrency violation

If a failover service group comes online on more than one node, the chances of data corruption increase. You can configure failover service groups that contain application resources for prevention of concurrency violation (PCV) by setting the group's ProPCV attribute to 1.

Note: You cannot set the ProPCV attribute for parallel service groups and for hybrid service groups.

You can set the ProPCV attribute when the service group is inactive on all the nodes or when the group is active (ONLINE, PARTIAL, or STARTING) on one node in the

cluster. You cannot set the ProPCV attribute if the service group is already online on multiple nodes in the cluster. See “Service group attributes” on page 789.

If ProPCV is set to 1, you cannot bring online processes that are listed in the MonitorProcesses attribute or the StartProgram attribute of the application resource on any other node in the cluster. If you try to start a process that is listed in the MonitorProcesses attribute or StartProgram attribute on any other node, that process is killed before it starts. Therefore, the service group does not get into concurrency violation.

Enabling or preventing resources to start outside VCS control

When a resource is brought online on one node in a cluster, the resource must not be allowed to come online outside VCS control on any other node in the cluster. By ensuring that the resource cannot be online on more than one node, you can prevent data corruption and ensure high availability through VCS.

The ProPCV attribute of the service group containing application resource determines whether or not to allow the processes for the application resource to start outside VCS control. The application type resource must be registered with IMF for offline monitoring or online monitoring. ProPCV applies only to the processes that are specified in the MonitorProcesses attribute or the StartProgram attribute of the application type resource. See the *Cluster Server Bundled Agents Reference Guide* for information about the propcv action agent function and also for information on when the application resource can be registered with IMF for offline monitoring.

Note: Currently, ProPCV works for application type resources only.

In situations where the propcv action agent function times out, you can use the amfregister command to manually mark a resource as one of the following:

- A resource that is allowed to be brought online outside VCS control.
- A resource that is prevented from being brought online outside VCS control. Such a ProPCV-enabled resource cannot be online on more than one node in the cluster.

To allow a resource to be started outside VCS control

- ◆ Type the following command:

```
amfregister -r reapername -g resourcename -P a
```

Example: `amfregister -r VCSApplicationAgent -g app1 -P a`

The application resource `app1` is allowed to start if you invoke it outside VCS control or from the command line.

To prevent a resource from being started outside VCS control

- ◆ Type the following command:

```
amfregister -r reapername -g resourcename -P p
```

Example: `amfregister -r VCSApplicationAgent -g app1 -P p`

The application resource `app1` is prevented from starting if you invoke it outside VCS control or from the command line.

In the preceding examples,

- *reapername* is the agent whose name is displayed under the Registered Reapers section of `amfstat` output. For application resources, *reapername* is `VCSApplicationAgent`.
- Option *r* indicates the name of the reaper or agent as displayed under the Registered Reapers section of the `amfstat` command's output. For application resources, reaper name is `VCSApplicationAgent`.
- *resourcename* is the resource name.
- Option *g* indicates the name of the resource. In the preceding example, the application resource is `app1`.
- Option *P* indicates whether to allow or prevent a resource from starting up outside VCS control.
 - Argument *a* denotes that the resource can be started outside VCS control.
 - Argument *p* denotes that the resource is prevented from starting outside VCS control.

Limitations of ProPCV

The following limitations apply:

- ProPCV feature is supported only when the Mode value for the IMF attribute of the Application type resource is set to 3 on all nodes in the cluster.
- The ProPCV feature does not protect against concurrency in the following cases:

- When you modify the `IMFRegList` attribute for the resource type.
- When you modify any value that is part of the `IMFRegList` attribute for the resource type.
- If you configure the application type resource for ProPCV, consider the following:
 - If you run the process with changed order of arguments, the ProPCV feature does not prevent the execution of the process.
For example, a single command can be run in multiple ways:

```
/usr/bin/tar -c -f a.tar
```

```
/usr/bin/tar -f a.tar -c
```

The ProPCV feature works only if you run the process the same way as it is configured in the resource configuration.

- If there are multiple ways or commands to start a process, ProPCV prevents the startup of the process only if the process is started in the way specified in the resource configuration.
- If the process is started using a script, the script must have the interpreter path as the first line and start with `#!`. For example, a shell script should start with `#!/usr/bin/sh`
- You can bring processes online outside VCS control on another node when a failover service group is auto-disabled.

Examples are:

- When you use the `hastop -local` command or the `hastop -local -force` command on a node.
- When a node is detected as `FAULTED` after its `ShutdownTimeout` value has elapsed because `HAD` exited.

In such situations, you can bring processes online outside VCS control on a node even if the failover service group is online on another node on which VCS engine is not running.

- Before you set ProPCV to 1 for a service group, you must ensure that none of the processes specified in the `MonitorProcesses` attribute or the `StartProgram` attribute of the application resource of the group are running on any node where the resource is offline. If an application resource lists two processes in its `MonitorProcesses` attribute, both processes need to be offline on all nodes in the cluster. If a node has only one process running and you set ProPCV to 1 for the group, you can still start the second process on another node because the Application agent cannot perform selective offline monitoring or online monitoring of individual processes for an application resource

- If a ProPCV-enabled service group has some application resources and some non-application type resources (that cannot be configured for ProPCV), the group can still get into concurrency violation for the non-application type resources. You can bring the non-application type resources online outside VCS control on a node when the service group is active on another node. In such cases, the concurrency violation trigger is invoked.
- The ProPCV feature is not supported for an application running in a container (such as WPAR).
- When ProPCV is enabled for a group, the AMF driver prevents certain processes from starting based on the process offline registrations with the AMF driver. If a process starts whose pathname and arguments match with the registered event, and if the prevent action is set for this registered event, that process is prevented from starting. Apart from that, if the arguments match, and even if only the basename of the starting process matches with the basename of the pathname of the registered event, AMF driver prevents that process from starting
- Even with ProPCV enabled, the AMF driver can prevent only those processes from starting whose pathname and arguments match with the events registered with the AMF driver. If the same process is started in some other manner (for example, with a totally different pathname), AMF driver does not prevent the process from starting. This behavior is in line with how AMF driver works for process offline monitoring.

VCS behavior for resources that support the intentional offline functionality

Certain agents can identify when an application has been intentionally shut down outside of VCS control.

For agents that support this functionality, if an administrator intentionally shuts down an application outside of VCS control, VCS does not treat it as a fault. VCS sets the service group state as offline or partial, depending on the state of other resources in the service group.

This feature allows administrators to stop applications without causing a failover. The feature is available for V51 agents.

About the IntentionalOffline attribute

To configure a resource to recognize an intentional offline of configured application, set the IntentionalOffline attribute to 1. Set the attribute to its default value of 0 to disable this functionality. IntentionalOffline is Type level attribute and not a resource level attribute.

You can configure the IntentionalOffline attribute with the following possible values:

- If you set the attribute to 1: When the application is intentionally stopped outside of VCS control, the resource enters an OFFLINE state. This attribute does not affect VCS behavior on application failure. VCS continues to fault resources if managed corresponding applications fail.
- If you set the attribute to 0: When the application is intentionally stopped outside of VCS control, the resource enters a FAULTED state.

About the ExternalStateChange attribute

Use the ExternalStateChange attribute to control service group behavior when a configured application is intentionally started or stopped outside of VCS control.

The attribute defines how VCS handles service group state when resources are intentionally brought online or taken offline outside of VCS control.

You can configure the ExternalStateChange attribute with the values listed in [Table 11-5](#).

Table 11-5 ExternalStateChange attribute values

Attribute value	Service group behavior
OnlineGroup	If the configured application is started outside of VCS control, VCS brings the corresponding service group online. If you attempt to start the application on a frozen node or service group, VCS brings the corresponding service group online once the node or the service group is unfrozen.
OfflineGroup	If the configured application is stopped outside of VCS control, VCS takes the corresponding service group offline.
OfflineHold	If a configured application is stopped outside of VCS control, VCS sets the state of the corresponding VCS resource as offline. VCS does not take any parent resources or the service group offline.

OfflineHold and OfflineGroup are mutually exclusive.

VCS behavior when a service group is restarted

The VCS engine behavior is determined by certain service group-level attributes when service groups are restarted.

VCS behavior when non-persistent resources restart

The OnlineRetryLimit and OnlineRetryInterval attributes determine the VCS behavior when the VCS engine attempts to bring a faulted non-persistent resource online.

The `OnlineRetryLimit` attribute allows a service group to be brought online again on the same system if a non-persistent resource in the service group faults. If, for some reason, the service group cannot be restarted, the VCS engine repeatedly tries to bring the service group online till the number of attempts that are specified by `OnlineRetryLimit` expires.

However, if the `OnlineRetryInterval` attribute is set to a non-zero value, the service group that has been successfully restarted faults again; it should be failed over. The service group should not be retried on the same system, even if the attribute `OnlineRetryLimit` is non-zero. This prevents a group from continuously faulting and restarting on the same system. The interval is measured in seconds.

VCS behavior when persistent resources transition from faulted to online

The `AutoRestart` attribute determines the VCS behavior in the following scenarios:

- A service group cannot be automatically started because of a faulted persistent resource
- A service group is unable to failover

Later, when a persistent resource transitions from `FAULTED` to `ONLINE`, the VCS engine attempts to bring the service group online if the `AutoRestart` attribute is set to 1 or 2.

If `AutoRestart` is set to 1, the VCS engine restarts the service group. If `AutoRestart` is set to 2, the VCS engine clears the faults on all faulted non-persistent resources in the service group before it restarts the service group on the same system

About controlling VCS behavior at the resource level

You can control VCS behavior at the resource level. Note that a resource is not considered faulted until the agent framework declares the fault to the VCS engine.

Certain attributes affect how the VCS agent framework reacts to problems with individual resources before informing the fault to the VCS engine.

Resource type attributes that control resource behavior

The following attributes affect how the VCS agent framework reacts to problems with individual resources before informing the fault to the VCS engine.

About the RestartLimit attribute

The RestartLimit attribute defines whether VCS attempts to restart a failed resource before it informs the engine of the fault.

If the RestartLimit attribute is set to a non-zero value, the agent attempts to restart the resource before it declares the resource as Faulted. When the agent framework restarts a failed resource, it first calls the Clean function and then the Online function. However, if the ManageFaults attribute is set to NONE, the agent does not call the Clean function and does not retry the Online function. If you configure the ManageFaults attribute at the resource level, it supersedes the values that are configured at the service group level.

About the OnlineRetryLimit attribute

The OnlineRetryLimit attribute specifies the number of times the Online function is retried if the initial attempt to bring a resource online is unsuccessful.

When OnlineRetryLimit is set to a non-zero value, the agent first calls the Clean function and then reruns the Online function. However, if the ManageFaults attribute is set to NONE, the agent does not call the Clean function and does not retry the Online function. If you configure the ManageFaults attribute at the resource level, it supersedes the values that are configured at the service group level.

About the ConflInterval attribute

The ConflInterval attribute defines how long a resource must remain online without encountering problems before previous problem counters are cleared. The attribute controls when VCS clears the RestartCount, ToleranceCount and CurrentMonitorTimeoutCount values.

About the ToleranceLimit attribute

The ToleranceLimit attribute defines the number of times the monitor routine should return an offline status before declaring a resource offline. This attribute is typically used when a resource is busy and appears to be offline. Setting the attribute to a non-zero value instructs VCS to allow multiple failing monitor cycles with the expectation that the resource will eventually respond. Setting a non-zero ToleranceLimit also extends the time required to respond to an actual fault.

About the FaultOnMonitorTimeouts attribute

The FaultOnMonitorTimeouts attribute defines whether VCS interprets a Monitor function timeout as a resource fault.

If the attribute is set to 0, VCS does not treat Monitor timeouts as a resource faults. If the attribute is set to 1, VCS interprets the timeout as a resource fault and the agent calls the Clean function to shut the resource down.

By default, the FaultOnMonitorTimeouts attribute is set to 4. This means that the Monitor function must time out four times in a row before the resource is marked faulted. The first monitor time out timer and the counter of time outs are reset after one hour of the first monitor time out.

How VCS handles resource faults

This section describes the process VCS uses to determine the course of action when a resource faults.

VCS behavior when an online resource faults

In the following example, a resource in an online state is reported as being offline without being commanded by the agent to go offline.

VCS goes through the following steps when an online resource faults:

- VCS first verifies the Monitor routine completes successfully in the required time. If it does, VCS examines the exit code returned by the Monitor routine. If the Monitor routine does not complete in the required time, VCS looks at the FaultOnMonitorTimeouts (FOMT) attribute.
- If FOMT=0, the resource will not fault when the Monitor routine times out. VCS considers the resource online and monitors the resource periodically, depending on the monitor interval.
If FOMT=1 or more, VCS compares the CurrentMonitorTimeoutCount (CMTC) with the FOMT value. If the monitor timeout count is not used up, CMTC is incremented and VCS monitors the resource in the next cycle.
- If FOMT= CMTC, this means that the available monitor timeout count is exhausted and VCS must now take corrective action. VCS checks the Frozen attribute for the service group. If the service group is frozen, VCS declares the resource faulted and calls the resfault trigger. No further action is taken.
- If the service group is not frozen, VCS checks the ManageFaults attribute at the resource level. VCS marks the resource as ONLINE|ADMIN_WAIT and fires the resadminwait trigger if its group-level value is NONE or if its resource-level value is IGNORE. If ManageFaults is set to ACT at the resource level or ALL at the group level, VCS invokes the Clean function with the reason Monitor Hung.

Note: The resource-level ManageFaults value supersedes the corresponding service group-level value. VCS honors the service group-level ManageFaults value only when the corresponding resource-level value is blank ("").

- If the Clean function is successful (that is, Clean exit code = 0), VCS examines the value of the RestartLimit attribute. If Clean fails (exit code = 1), the resource remains online with the state UNABLE TO OFFLINE. VCS fires the resnotoff trigger and monitors the resource again.
- If the Monitor routine does not time out, it returns the status of the resource as being online or offline.
- If the ToleranceLimit (TL) attribute is set to a non-zero value, the Monitor cycle returns offline (exit code = 100) for a number of times specified by the ToleranceLimit and increments the ToleranceCount (TC). When the ToleranceCount equals the ToleranceLimit (TC = TL), the agent declares the resource as faulted.
- If the Monitor routine returns online (exit code = 110) during a monitor cycle, the agent takes no further action. The ToleranceCount attribute is reset to 0 when the resource is online for a period of time specified by the ConflInterval attribute.
If the resource is detected as being offline a number of times specified by the ToleranceLimit before the ToleranceCount is reset (TC = TL), the resource is considered faulted.
- After the agent determines the resource is not online, VCS checks the Frozen attribute for the service group. If the service group is frozen, VCS declares the resource faulted and calls the resfault trigger. No further action is taken.
- If the service group is not frozen, VCS checks the ManageFaults attribute. If ManageFaults=NONE, VCS marks the resource state as ONLINE|ADMIN_WAIT and calls the resadminwait trigger. If ManageFaults=ALL, VCS calls the Clean function with the CleanReason set to Unexpected Offline.
- If the Clean function fails (exit code = 1) the resource remains online with the state UNABLE TO OFFLINE. VCS fires the resnotoff trigger and monitors the resource again. The resource enters a cycle of alternating Monitor and Clean functions until the Clean function succeeds or a user intervenes.
- If the Clean function is successful, VCS examines the value of the RestartLimit (RL) attribute. If the attribute is set to a non-zero value, VCS increments the RestartCount (RC) attribute and invokes the Online function. This continues till the value of the RestartLimit equals that of the RestartCount. At this point, VCS attempts to monitor the resource.

- If the Monitor returns an online status, VCS considers the resource online and resumes periodic monitoring. If the monitor returns an offline status, the resource is faulted and VCS takes actions based on the service group configuration.

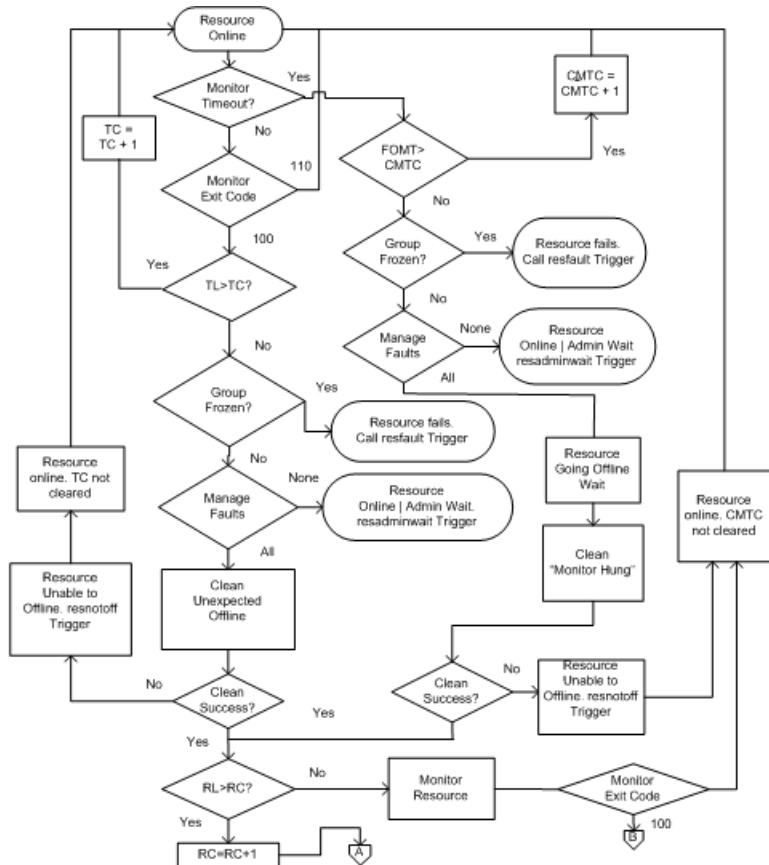

VCS behavior when a resource fails to come online

In the following example, the agent framework invokes the Online function for an offline resource. The resource state changes to WAITING TO ONLINE.

VCS goes through the following steps when a resource fails to come online:

- If the Online function times out, VCS examines the value of the ManageFaults attribute first at the resource level and then at the service group level. If ManageFaults is defined at the resource level, VCS overrides the corresponding

values that are specified at the service group level. VCS takes action based on the ManageFaults values that are specified at the resource level.

- If ManageFaults is set to IGNORE at the resource level, the resource state changes to OFFLINE|ADMIN_WAIT. The resource-level value overrides the service group-level value.
- If ManageFaults is set to ACT at the resource level, VCS calls the Clean function with the CleanReason set to Online Hung.
- If resource-level ManageFaults is set to "" or blank, VCS checks the corresponding service group-level value, and proceeds as follows:
 - If ManageFaults is set to NONE, the resource state changes to OFFLINE|ADMIN_WAIT.
 - If ManageFaults is set to ALL, VCS calls the Clean function with the CleanReason set to Online Hung.
- If ManageFaults is set to NONE, the resource state changes to OFFLINE|ADMIN_WAIT.
If ManageFaults is set to ALL, VCS calls the Clean function with the CleanReason set to Online Hung.
- If the Online function does not time out, VCS invokes the Monitor function. The Monitor routine returns an exit code of 110 if the resource is online. Otherwise, the Monitor routine returns an exit code of 100.
- VCS examines the value of the OnlineWaitLimit (OWL) attribute. This attribute defines how many monitor cycles can return an offline status before the agent framework declares the resource faulted. Each successive Monitor cycle increments the OnlineWaitCount (OWC) attribute. When OWL= OWC (or if OWL= 0), VCS determines the resource has faulted.
- VCS then examines the value of the ManageFaults attribute. If the ManageFaults is set to NONE, the resource state changes to OFFLINE|ADMIN_WAIT. If the ManageFaults is set to ALL, VCS calls the Clean function with the CleanReason set to Online Ineffective.
- If the Clean function is not successful (exit code = 1), the agent monitors the resource. It determines the resource is offline, and calls the Clean function with the Clean Reason set to Online Ineffective. This cycle continues till the Clean function is successful, after which VCS resets the OnlineWaitCount value.
- If the OnlineRetryLimit (ORL) is set to a non-zero value, VCS increments the OnlineRetryCount (ORC) and invokes the Online function. This starts the cycle all over again. If ORL = ORC, or if ORL = 0, VCS assumes that the Online operation has failed and declares the resource as faulted.

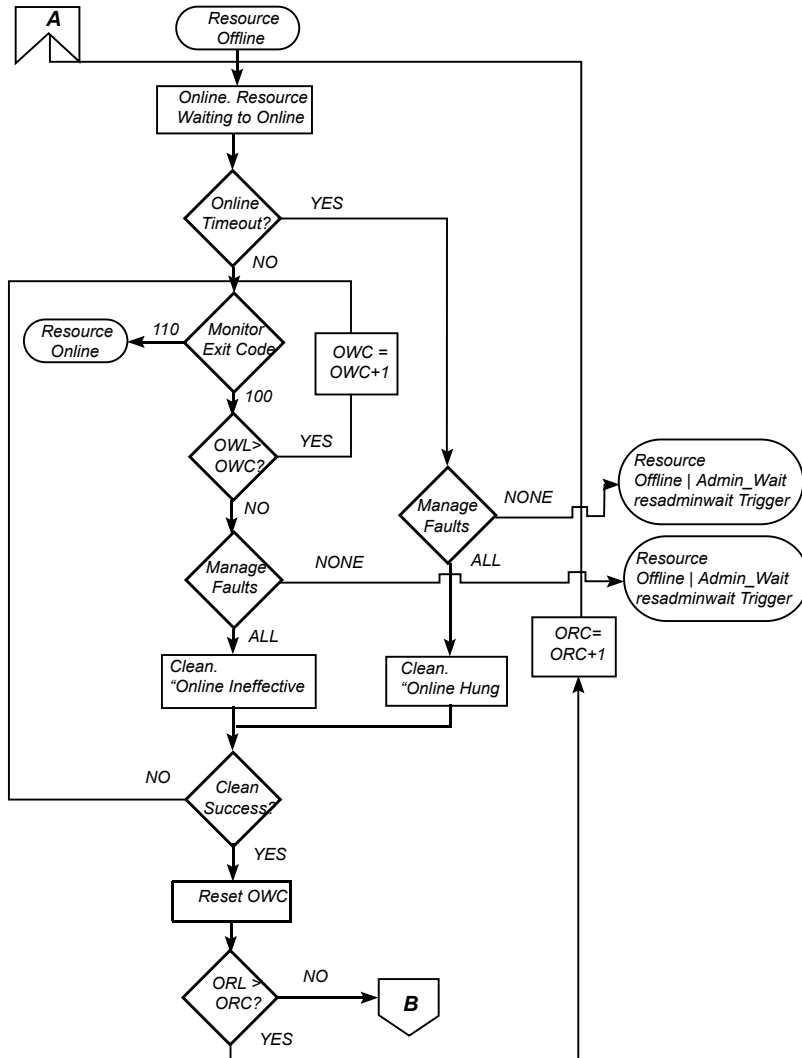

VCS behavior after a resource is declared faulted

After a resource is declared faulted, VCS fires the resfault trigger and examines the value of the FaultPropagation attribute.

VCS goes through the following steps after a resource is declared faulted:

- If FaultPropagation is set to 0, VCS does not take other resources offline, and changes the group state to OFFLINE|FAULTED or PARTIAL|FAULTED. The service group does not fail over.

If FaultPropagation is set to 1, VCS takes all resources in the dependent path of the faulted resource offline, up to the top of the tree.

- VCS then examines if any resource in the dependent path is critical. If no resources are critical, the service group is left in its OFFLINE|FAULTED or PARTIAL|FAULTED state. If a resource in the path is critical, VCS takes the all resources in the service group offline in preparation of a failover.
- If the AutoFailOver attribute is set to 0, the service group is not failed over; it remains in a faulted state. If AutoFailOver is set to 1, VCS examines if any systems in the service group's SystemList are possible candidates for failover. If no suitable systems exist, the group remains faulted and VCS calls the nofailover trigger. If eligible systems are available, VCS examines the FailOverPolicy to determine the most suitable system to which to fail over the service group.
- If FailOverPolicy is set to Load, a NoFailover situation may occur because of restrictions placed on service groups and systems by Service Group Workload Management.

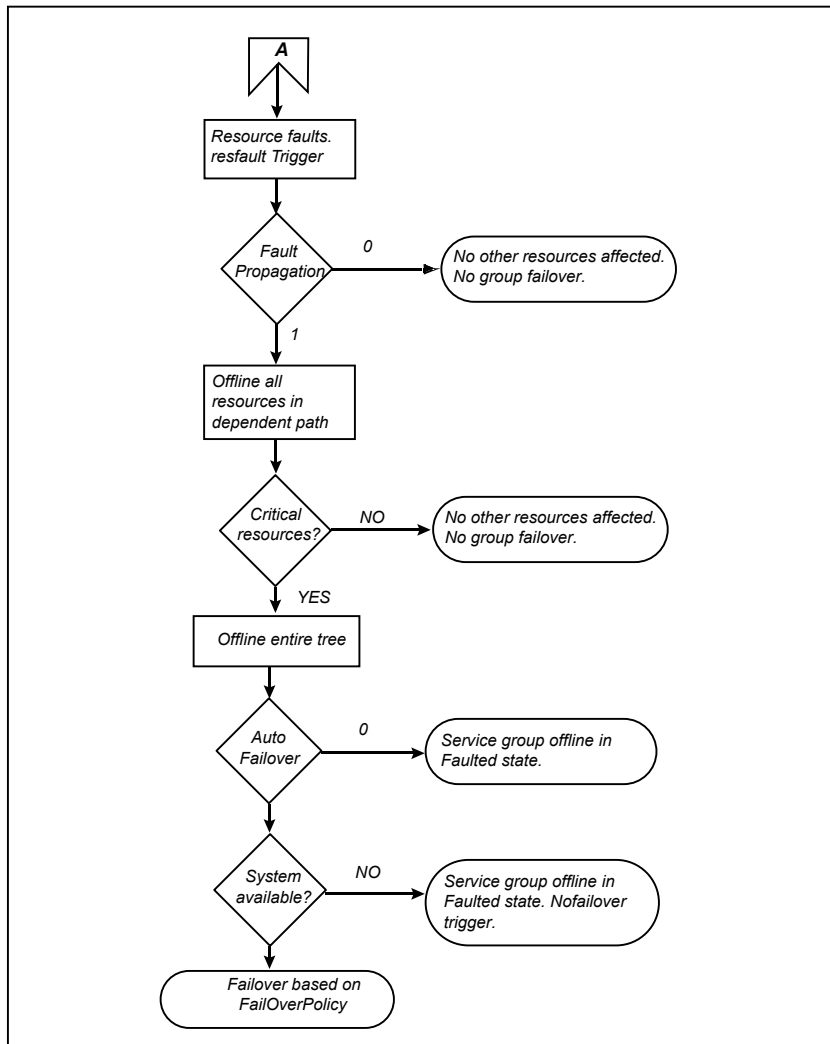

VCS behavior when a resource is restarted

The behavior of VCS agents is determined by certain resource-level attributes when resources are restarted.

VCS behavior when online agent function fails to bring a resource online

You can use the `OnlineRetryLimit` attribute to specify the number of retries that the agent should perform to bring the resource online.

VCS behavior when a resource goes offline

The `RestartLimit` attribute can be used to specify the number of retries that an agent should perform to bring a resource online before the VCS engine declares the resource as `FAULTED`.

The `ToleranceLimit` attribute defines the number of times the monitor agent function can return unexpected `OFFLINE` before it declares the resource as `FAULTED`. A large `ToleranceLimit` value delays detection of a genuinely faulted resource.

For example, assume that `RestartLimit` is set to 2 and `ToleranceLimit` is set to 3 for a resource and that the resource state is `ONLINE`. If the next monitor detects the resource state as `OFFLINE`, the agent waits for another monitor cycle instead of triggering a restart. The agent waits a maximum of 3 (`ToleranceLimit`) monitor cycles before it triggers a restart.

The `RestartLimit` and `ToleranceLimit` attributes determine the VCS behavior in the following scenarios:

- The `RestartLimit` attribute is considered when the resource state is `ONLINE` and next monitor cycle detects it as `OFFLINE` and `ToleranceLimit` is reached.
- The `OnlineRetryLimit` attribute is considered when the resource is to be brought online.

About disabling resources

Disabling a resource means that the resource is no longer monitored by a VCS agent, and that the resource cannot be brought online or taken offline. The agent starts monitoring the resource after the resource is enabled. The resource attribute `Enabled` determines whether a resource is enabled or disabled. A persistent resource can be disabled when all its parents are offline. A non-persistent resource can be disabled when the resource is in an `OFFLINE` state.

When to disable a resource

Typically, resources are disabled when one or more resources in the service group encounter problems and disabling the resource is required to keep the service group online or to bring it online.

Note: Disabling a resource is not an option when the entire service group requires disabling. In that case, set the service group attribute Enabled to 0.

Use the following command to disable the resource when VCS is running:

```
# hares -modify resource_name Enabled 0
```

To have the resource disabled initially when VCS is started, set the resource's Enabled attribute to 0 in main.cf.

Limitations of disabling resources

When VCS is running, there are certain prerequisites to be met before the resource is disabled successfully.

- An online non-persistent resource cannot be disabled. It must be in a clean OFFLINE state. (The state must be OFFLINE and IState must be NOT WAITING.)
- If it is a persistent resource and the state is ONLINE on some of the systems, all dependent resources (parents) must be in clean OFFLINE state. (The state must be OFFLINE and IState must be NOT WAITING)

Therefore, before disabling the resource you may be required to take it offline (if it is non-persistent) and take other resources offline in the service group.

Additional considerations for disabling resources

Following are the additional considerations for disabling resources:

- When a group containing disabled resources is brought online, the online transaction is not propagated to the disabled resources. Children of the disabled resource are brought online by VCS only if they are required by another enabled resource.
- You can bring children of disabled resources online if necessary.
- When a group containing disabled resources is taken offline, the offline transaction is propagated to the disabled resources.
- If a service group is part of an `hagrps -online -propagate` operation or an `hagrps -offline -propagate` operation and a resource in the service group is disabled, the resource might not complete its online operation or offline operation. In this case, PolicyIntention of the service group is set to 0.
In an `hagrps online -propagate` operation, if the child service groups cannot be brought online, the parent service groups also cannot be brought online. Therefore, when the PolicyIntention value of 1 for the child service group is cleared, the PolicyIntention value of all its parent service groups in dependency

tree is also cleared. When the PolicyIntention value of 2 for the parent service group is cleared, the PolicyIntention value of all its child service groups in dependency tree is also cleared.

This section shows how a service group containing disabled resources is brought online.

Figure 11-9 shows Resource_3 is disabled. When the service group is brought online, the only resources brought online by VCS are Resource_1 and Resource_2 (Resource_2 is brought online first) because VCS recognizes Resource_3 is disabled. In accordance with online logic, the transaction is not propagated to the disabled resource.

Figure 11-9 Scenario: Transaction not propagated to the disabled resource (Resource_3)

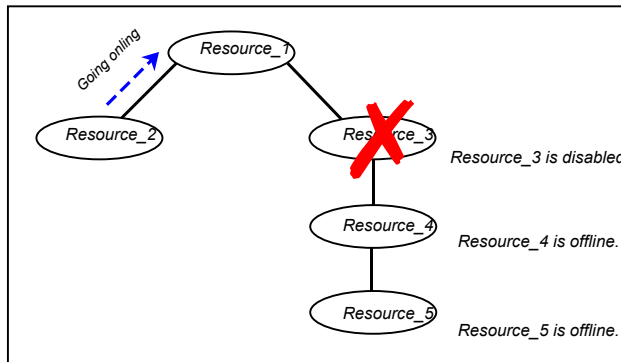
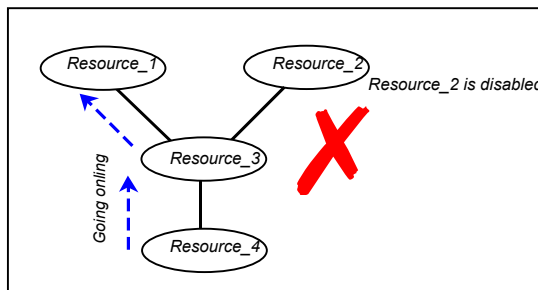

Figure 11-10, shows that Resource_2 is disabled. When the service group is brought online, resources 1, 3, 4 are also brought online (Resource_4 is brought online first). Note Resource_3, the child of the disabled resource, is brought online because Resource_1 is enabled and is dependent on it.

Figure 11-10 Scenario: Child of the disabled resource (Resource_3) is brought online



How disabled resources affect group states

When a service group is brought online containing non-persistent, disabled resources whose AutoStart attributes are set to 1, the group state is PARTIAL, even though enabled resources with Autostart=1 are online. This is because the disabled resource is considered for the group state.

To have the group in the ONLINE state when enabled resources with AutoStart set to 1 are in ONLINE state, set the AutoStart attribute to 0 for the disabled, non-persistent resources.

Changing agent file paths and binaries

By default, VCS runs agent binaries from the path `$VCS_HOME/bin/AgentName/AgentNameAgent`. For example, `/opt/VRTSvcs/bin/FileOnOff/FileOnOffAgent`.

You can instruct VCS to run a different set of agent binaries or scripts by specifying values for the following attributes.

- **AgentFile:**
Specify a value for this attribute if the name of the agent binary is not the same as that of the resource type.
For example, if the resource type is MyApplication and the agent binary is called MyApp, set the AgentFile attribute to MyApp. For a script-based agent, you could configure AgentFile as `/opt/VRTSvcs/bin/ScriptAgent`.
- **AgentDirectory:**
Specify a value for this attribute if the agent is not installed at the default location. When you specify the agent directory, VCS looks for the agent file (*AgentNameAgent*) in the agent directory. If the agent file name does not conform to the *AgentNameAgent* convention, configure the AgentFile attribute.
For example, if the MyApplication agent is installed at `/opt/VRTSvcs/bin/CustomAgents/MyApplication`, specify this path as the attribute value. If the agent file is not named MyApplicationAgent, configure the AgentFile attribute.
If you do not set these attributes and the agent is not available at its default location, VCS looks for the agent at the `/opt/VRTSagents/ha/bin/AgentName/AgentNameAgent`.

To change the path of an agent

- ◆ Before configuring a resource for the agent, set the AgentFile and AgentDirectory attributes of the agent's resource type.

```
hatype -modify resource_type AgentFile \  
    "binary_name"  
hatype -modify resource_type AgentDirectory \  
    "complete_path_to_agent_binary"
```

VCS behavior on loss of storage connectivity

When a node loses connectivity to shared storage, input-output operations (I/O) to volumes return errors and the disk group gets disabled. In this situation, VCS must fail the service groups over to another node. This failover is to ensure that applications have access to shared storage. The failover involves deporting disk groups from one node and importing them to another node. However, pending I/Os must complete before the disabled disk group can be deported.

Pending I/Os cannot complete without storage connectivity. When VCS is not configured with I/O fencing and the PanicSystemOnDGLoss attribute of DiskGroup is not configured to panic the system, VCS assumes data is being read from or written to disks and does not declare the DiskGroup resource as offline. This behavior prevents potential data corruption that may be caused by the disk group being imported on two hosts. However, this also means that service groups remain online on a node that does not have storage connectivity and the service groups cannot be failed over unless an administrator intervenes. This affects application availability.

Some Fibre Channel (FC) drivers have a configurable parameter called failover, which defines the number of seconds for which the driver retries I/O commands before returning an error. If you set the failover parameter to 0, the FC driver retries I/O infinitely and does not return an error even when storage connectivity is lost. This also causes the Monitor function for the DiskGroup to time out and prevents failover of the service group unless an administrator intervenes.

Disk group configuration and VCS behavior

[Table 11-6](#) describes how the disk group state and the failover attribute define VCS behavior when a node loses connectivity to shared storage.

Table 11-6 Disk group state and the failover attribute define VCS behavior

Case	DiskGroup state	Failover attribute	VCS behavior on loss of storage connectivity
1	Enabled	N seconds	Fails over service groups to another node.
2	Disabled	N seconds	DiskGroup resource remains online. No failover.
3	Enabled	0	DiskGroup resource remains in monitor timed out state. No failover.
4	Disabled	0	DiskGroup resource remains online. No failover.

How VCS attributes control behavior on loss of storage connectivity

You can configure VCS attributes to ensure that a node panics on losing connectivity to shared storage. The panic causes service groups to fail over to another node.

A system reboot or shutdown could leave the system in a hung state because the operating system cannot dump the buffer cache to the disk. The panic operation ensures that VCS does not wait for I/Os to complete before triggering the failover mechanism, thereby ensuring application availability. However, you might have to perform a file system check when you restart the node.

The following attributes of the Diskgroup agent define VCS behavior on loss of storage connectivity:—

PanicSystemOnDGLoss	Defines whether the agent panics the system when storage connectivity is lost or Monitor times out.
---------------------	---

FaultOnMonitorTimeouts

Specifies the number of consecutive monitor timeouts after which VCS calls the Clean function to mark the resource as FAULTED or restarts the resource.

If you set the attribute to 0, VCS does not treat a Monitor timeout as a resource fault. By default, the attribute is set to 4. This means that the Monitor function must time out four times in a row before VCS marks the resource faulted.

When the Monitor function for the DiskGroup agent times out, (case 3 in the preceding table), the FaultOnMonitorTimeouts attribute defines when VCS interprets the resource as faulted and invokes the Clean function. If the CleanReason is "monitor hung", the system panics.

For details about these attributes, see the *Cluster Server Bundled Agents Reference Guide*.

VCS behavior when a disk group is disabled

Figure 11-11 describes VCS behavior for a disabled diskgroup.

Figure 11-11 VCS behavior when a disk group is disabled

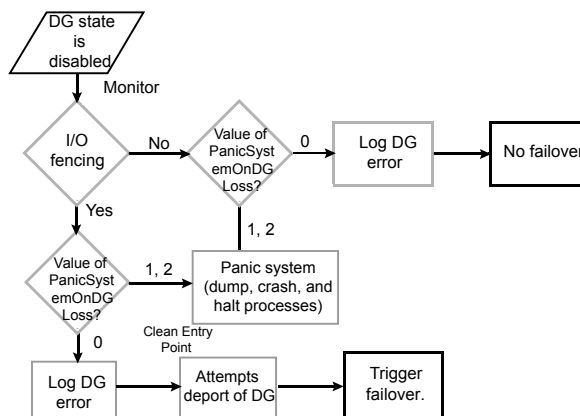

Recommendations to ensure application availability

Veritas makes the following recommendations to ensure application availability and data integrity when a node loses connectivity to shared storage:

- Do not set the failover attribute for the FC driver to 0.
However, if you do set the failover attribute to 0, set the `FaultOnMonitorTimeouts` value for the `DiskGroup` resource type to a finite value.
- If you use I/O fencing, set the `PanicSystemOnDGLoss` attribute for the `DiskGroup` resource to appropriate value as per requirement. This ensures that the system panics when it loses connectivity to shared storage or monitor program timeout for `FaultOnMonitorTimeouts` value, and causes applications to fail over to another node. The failover ensures application availability, while I/O fencing ensures data integrity.

Service group workload management

Workload management is a load-balancing mechanism that determines which system hosts an application during startup, or after an application or server fault.

Service Group Workload Management provides tools for making intelligent decisions about startup and failover locations, based on system capacity and resource availability.

About enabling service group workload management

The service group attribute `FailOverPolicy` governs how VCS calculates the target system for failover. Set `FailOverPolicy` to `Load` to enable service group workload management.

See “[About controlling VCS behavior at the resource level](#)” on page 439.

System capacity and service group load

The `Load and Capacity` construct allows the administrator to define a fixed amount of resources a server provides (`Capacity`), and a fixed amount of resources a specific service group is expected to utilize (`Load`).

The system attribute `Capacity` sets a fixed load-handling capacity for servers. Define this attribute based on system requirements.

The service group attribute `Load` sets a fixed demand for service groups. Define this attribute based on application requirements.

When a service group is brought online, its load is subtracted from the system's capacity to determine available capacity. VCS maintains this info in the attribute `AvailableCapacity`.

When a failover occurs, VCS determines which system has the highest available capacity and starts the service group on that system. During a failover involving multiple service groups, VCS makes failover decisions serially to facilitate a proper load-based choice.

System capacity is a soft restriction; in some situations, value of the `Capacity` attribute could be less than zero. During some operations, including cascading failures, the value of the `AvailableCapacity` attribute could be negative.

Static load versus dynamic load

Dynamic load is an integral component of the Service Group Workload Management framework. Typically, HAD sets remaining capacity with the function:

$$\text{AvailableCapacity} = \text{Capacity} - (\text{sum of Load values of all online service groups})$$

If the `DynamicLoad` attribute is defined, its value overrides the calculated Load values with the function:

$$\text{AvailableCapacity} = \text{Capacity} - \text{DynamicLoad}$$

This enables better control of system loading values than estimated service group loading (static load). However, this requires setting up and maintaining a load estimation package outside VCS. It also requires modifying the configuration file `main.cf` manually.

Note that the `DynamicLoad` (specified with `hasys -load`) is subtracted from the `Capacity` as an integer and not a percentage value. For example, if a system's capacity is 200 and the load estimation package determines the server is 80 percent loaded, it must inform VCS that the `DynamicLoad` value is 160 (not 80).

About overload warning

Overload warning provides the notification component of the Load policy. When a server sustains the preset load level (set by the attribute `LoadWarningLevel`) for a preset time (set by the attribute `LoadTimeThreshold`), VCS invokes the loadwarning trigger.

See [“Using event triggers”](#) on page 516.

See [System attributes](#) on page 816.

The loadwarning trigger is a user-defined script or application designed to carry out specific actions. It is invoked once, when system load exceeds the `LoadWarningLevel` for the `LoadTimeThreshold`. It is not invoked again until the

LoadTimeCounter, which determines how many seconds system load has been above LoadWarningLevel, is reset.

System limits and service group prerequisites

Limits is a system attribute and designates which resources are available on a system, including shared memory segments and semaphores.

Prerequisites is a service group attribute and helps manage application requirements. For example, a database may require three shared memory segments and 10 semaphores. VCS Load policy determines which systems meet the application criteria and then selects the least-loaded system.

If the prerequisites defined for a service group are not met on a system, the service group cannot be brought online on the system.

When configuring these attributes, define the service group's prerequisites first, then the corresponding system limits. Each system can have a different limit and there is no cap on the number of group prerequisites and system limits. Service group prerequisites and system limits can appear in any order.

You can also use these attributes to configure the cluster as N-to-1 or N-to-N. For example, to ensure that only one service group can be online on a system at a time, add the following entries to the definition of each group and system:

```
Prerequisites = { GroupWeight = 1 }  
Limits = { GroupWeight = 1 }
```

System limits and group prerequisites work independently of FailOverPolicy. Prerequisites determine the eligible systems on which a service group can be started. When a list of systems is created, HAD then follows the configured FailOverPolicy.

About capacity and limits

When selecting a node as a failover target, VCS selects the system that meets the service group's prerequisites and has the highest available capacity. If multiple systems meet the prerequisites and have the same available capacity, VCS selects the system appearing lexically first in the SystemList.

Systems having an available capacity of less than the percentage set by the LoadWarningLevel attribute, and those remaining at that load for longer than the time specified by the LoadTimeThreshold attribute invoke the loadwarning trigger.

Sample configurations depicting workload management

This topic lists some sample configurations that use the concepts.

System and Service group definitions

The main.cf in this example shows various Service Group Workload Management attributes in a system definition and a service group definition.

See [“About attributes and their definitions”](#) on page 763.

```
include "types.cf"
cluster SGWM-demo (
)

system LargeServer1 (
  Capacity = 200
  Limits = { ShrMemSeg=20, Semaphores=10, Processors=12 }
  LoadWarningLevel = 90
  LoadTimeThreshold = 600
)

system LargeServer2 (
  Capacity = 200
  Limits = { ShrMemSeg=20, Semaphores=10, Processors=12 }
  LoadWarningLevel=70
  LoadTimeThreshold=300
)

system MedServer1 (
  Capacity = 100
  Limits = { ShrMemSeg=10, Semaphores=5, Processors=6 }
)

system MedServer2 (
  Capacity = 100
  Limits = { ShrMemSeg=10, Semaphores=5, Processors=6 }
)

group G1 (
  SystemList = { LargeServer1 = 0, LargeServer2 = 1,
                MedServer1 = 2 , MedServer2 = 3 }
  SystemZones = { LargeServer1=0, LargeServer2=0,
```

```
        MedServer1=1, MedServer2=1 }
AutoStartPolicy = Load
AutoStartList = { MedServer1, MedServer2 }
FailOverPolicy = Load
Load = { Units = 100 }
Prerequisites = { ShrMemSeg=10, Semaphores=5, Processors=6 }
)
```

Sample configuration: Basic four-node cluster

Following is the sample configuration for a basic four-node cluster:

```
include "types.cf"
cluster SGWM-demo

system Server1 (
    Capacity = 100
)

system Server2 (
    Capacity = 100
)

system Server3 (
    Capacity = 100
)

system Server4 (
    Capacity = 100
)

group G1 (
    SystemList = { Server1 = 0, Server2 = 1,
                  Server3 = 2, Server4 = 3 }
    AutoStartPolicy = Load
    AutoStartList = { Server1 = 0, Server2 = 1,
                    Server3 = 2, Server4 = 3 }
    FailOverPolicy = Load
    Load = { CPU = 1, Mem = 2000 }
)

group G2 (
    SystemList = { Server1 = 0, Server2 = 1,
```

```
        Server3 = 2, Server4 = 3 }
    AutoStartPolicy = Load
    AutoStartList = { Server1, Server2, Server3, Server4 }
    FailOverPolicy = Load
    Load = { Units = 40 }
)

group G3 (
    SystemList = { Server1 = 0, Server2 = 1,
                  Server3 = 2, Server4 = 3 }
    AutoStartPolicy = Load
    AutoStartList = { Server1, Server2, Server3, Server4 }
    FailOverPolicy = Load
    Load = { Units = 30 }
)

group G4 (
    SystemList = { Server1 = 0, Server2 = 1,
                  Server3 = 2, Server4 = 3 }
    AutoStartPolicy = Load
    AutoStartList = { Server1, Server2, Server3, Server4 }
    FailOverPolicy = Load
    Load = { Units = 10 }
)

group G5 (
    SystemList = { Server1 = 0, Server2 = 1,
                  Server3 = 2, Server4 = 3 }
    AutoStartPolicy = Load
    AutoStartList = { Server1, Server2, Server3, Server4 }
    FailOverPolicy = Load
    Load = { Units = 50 }
)

group G6 (
    SystemList = { Server1 = 0, Server2 = 1,
                  Server3 = 2, Server4 = 3 }
    AutoStartPolicy = Load
    AutoStartList = { Server1, Server2, Server3, Server4 }
    FailOverPolicy = Load
    Load = { Units = 30 }
)
```



```

group G7 (
    SystemList = { Server1 = 0, Server2 = 1,
                  Server3 = 2, Server4 = 3 }
    AutoStartPolicy = Load
    AutoStartList = { Server1, Server2, Server3, Server4 }
    FailOverPolicy = Load
    Load = { Units = 20 }
)

group G8 (
    SystemList = { Server1 = 0, Server2 = 1,
                  Server3 = 2, Server4 = 3 }
    AutoStartPolicy = Load
    AutoStartList = { Server1, Server2, Server3, Server4 }
    FailOverPolicy = Load
    Load = { Units = 40 }
)

```

See [“About AutoStart operation”](#) on page 461.

About AutoStart operation

In this configuration, assume that groups probe in the same order they are described, G1 through G8. Group G1 chooses the system with the highest AvailableCapacity value. All systems have the same available capacity, so G1 starts on Server1 because this server is lexically first. Groups G2 through G4 follow on Server2 through Server4.

[Table 11-7](#) shows the Autostart cluster configuration for a basic four-node cluster with the initial four service groups online.

Table 11-7 Autostart cluster configuration for a basic four-node cluster

Server	Available capacity	Online groups
Server1	80	G1
Server2	60	G2
Server3	70	G3
Server4	90	G4

As the next groups come online, group G5 starts on Server4 because this server has the highest AvailableCapacity value. Group G6 then starts on Server1 with

AvailableCapacity of 80. Group G7 comes online on Server3 with AvailableCapacity of 70 and G8 comes online on Server2 with AvailableCapacity of 60.

Table 11-8 shows the Autostart cluster configuration for a basic four-node cluster with the other service groups online.

Table 11-8 Autostart cluster configuration for a basic four-node cluster with the other service groups online

Server	Available capacity	Online groups
Server1	50	G1 and G6
Server2	20	G2 and G8
Server3	50	G3 and G7
Server4	40	G4 and G5

In this configuration, Server2 fires the loadwarning trigger after 600 seconds because it is at the default LoadWarningLevel of 80 percent.

About the failure scenario

In the first failure scenario, Server4 fails. Group G4 chooses Server1 because Server1 and Server3 have AvailableCapacity of 50 and Server1 is lexically first. Group G5 then comes online on Server3. Serializing the failover choice allows complete load-based control and adds less than one second to the total failover time.

Table 11-9 shows the cluster configuration following the first failure for a basic four-node cluster.

Table 11-9 Cluster configuration following the first failure

Server	Available capacity	Online groups
Server1	40	G1, G6, and G4
Server2	20	G2 and G8
Server3	0	G3, G7, and G5

In this configuration, Server3 fires the loadwarning trigger to notify that the server is overloaded. An administrator can then switch group G7 to Server1 to balance the load across groups G1 and G3. When Server4 is repaired, it rejoins the cluster with an AvailableCapacity value of 100, making it the most eligible target for a failover group.

About the cascading failure scenario

If Server3 fails before Server4 can be repaired, group G3 chooses Server1, group G5 chooses Server2, and group G7 chooses Server1. This results in the following configuration:

[Table 11-10](#) shows a cascading failure scenario for a basic four node cluster.

Table 11-10 Cascading failure scenario for a basic four node cluster

Server	Available capacity	Online groups
Server1	-10	G1, G6, G4, G3, and G7
Server2	-30	G2, G8, and G5

Server1 fires the loadwarning trigger to notify that it is overloaded.

Sample configuration: Complex four-node cluster

The cluster in this example has two large enterprise servers (LargeServer1 and LargeServer2) and two medium-sized servers (MedServer1 and MedServer2). It has four service groups, G1 through G4, with various loads and prerequisites. Groups G1 and G2 are database applications with specific shared memory and semaphore requirements. Groups G3 and G4 are middle-tier applications with no specific memory or semaphore requirements.

```
include "types.cf"
cluster SGWM-demo (
)

system LargeServer1 (
Capacity = 200
Limits = { ShrMemSeg=20, Semaphores=10, Processors=12 }
LoadWarningLevel = 90
LoadTimeThreshold = 600
)

system LargeServer2 (
Capacity = 200
Limits = { ShrMemSeg=20, Semaphores=10, Processors=12 }
LoadWarningLevel=70
LoadTimeThreshold=300
)

system MedServer1 (
```

```
Capacity = 100
Limits = { ShrMemSeg=10, Semaphores=5, Processors=6 }
)

system MedServer2 (
Capacity = 100
Limits = { ShrMemSeg=10, Semaphores=5, Processors=6 }
)

group G1 (
SystemList = { LargeServer1 = 0, LargeServer2 = 1,
               MedServer1 = 2, MedServer2 = 3 }
SystemZones = { LargeServer1=0, LargeServer2=0, MedServer1=1,
                 MedServer2=1 }
AutoStartPolicy = Load
AutoStartList = { LargeServer1, LargeServer2 }
FailOverPolicy = Load
Load = { Units = 100 }
Prerequisites = { ShrMemSeg=10, Semaphores=5, Processors=6 }
)

group G2 (
SystemList = { LargeServer1 = 0, LargeServer2 = 1,
               MedServer1 = 2, MedServer2 = 3 }
SystemZones = { LargeServer1=0, LargeServer2=0, MedServer1=1,
                 MedServer2=1 }
AutoStartPolicy = Load
AutoStartList = { LargeServer1, LargeServer2 }
FailOverPolicy = Load
Load = { Units = 100 }
Prerequisites = { ShrMemSeg=10, Semaphores=5, Processors=6 }
)

group G3 (
SystemList = { LargeServer1 = 0, LargeServer2 = 1,
               MedServer1 = 2, MedServer2 = 3 }
SystemZones = { LargeServer1=0, LargeServer2=0, MedServer1=1,
                 MedServer2=1 }
AutoStartPolicy = Load
AutoStartList = { MedServer1, MedServer2 }
FailOverPolicy = Load
Load = { Units = 30 }
)
```

```

group G4 (
SystemList = { LargeServer1 = 0, LargeServer2 = 1,
               MedServer1 = 2, MedServer2 = 3 }
SystemZones = { LargeServer1=0, LargeServer2=0, MedServer1=1,
                MedServer2=1 }
AutoStartPolicy = Load
AutoStartList = { MedServer1, MedServer2 }
FailOverPolicy = Load
Load = { Units = 20 }
)

```

About the AutoStart operation

In this configuration, the AutoStart sequence resembles:

G1—LargeServer1

G2—LargeServer2

G3—MedServer1

G4—MedServer2

All groups begin a probe sequence when the cluster starts. Groups G1 and G2 have an AutoStartList of LargeServer1 and LargeServer2. When these groups probe, they are queued to go online on one of these servers, based on highest AvailableCapacity value. If G1 probes first, it chooses LargeServer1 because LargeServer1 and LargeServer2 both have an AvailableCapacity of 200, but LargeServer1 is lexically first. Groups G3 and G4 use the same algorithm to determine their servers.

About the normal operation

[Table 11-11](#) shows the cluster configuration for a normal operation for a complex four-node cluster.

Table 11-11 Normal operation cluster configuration for a complex four-node cluster

Server	Available capacity	Current limits	Online groups
LargeServer1	100	ShrMemSeg=10 Semaphores=5 Processors=6	G1

Table 11-11 Normal operation cluster configuration for a complex four-node cluster *(continued)*

Server	Available capacity	Current limits	Online groups
LargeServer2	100	ShrMemSeg=10 Semaphores=5 Processors=6	G2
MedServer1	70	ShrMemSeg=10 Semaphores=5 Processors=6	G3
MedServer2	80	ShrMemSeg=10 Semaphores=5 Processors=6	G4

About the failure scenario

In this scenario, if LargeServer2 fails, VCS scans all available systems in group G2's SystemList that are in the same SystemZone and creates a subset of systems that meet the group's prerequisites. In this case, LargeServer1 meets all required Limits. Group G2 is brought online on LargeServer1. This results in the following configuration:

[Table 11-12](#) shows a failure scenario cluster configuration for a complex four-node cluster.

Table 11-12 Failure scenario cluster configuration for a complex four-node cluster

Server	Available capacity	Current limits	Online groups
LargeServer1	0	ShrMemSeg=0 Semaphores=0 Processors=0	G1, G2
MedServer1	70	ShrMemSeg=10 Semaphores=5 Processors=6	G3

Table 11-12 Failure scenario cluster configuration for a complex four-node cluster (*continued*)

Server	Available capacity	Current limits	Online groups
MedServer2	80	ShrMemSeg=10 Semaphores=5 Processors=6	G4

After 10 minutes (LoadTimeThreshold = 600) VCS fires the loadwarning trigger on LargeServer1 because the LoadWarningLevel exceeds 90 percent.

About the cascading failure scenario

In this scenario, another system failure can be tolerated because each system has sufficient Limits to accommodate the service group running on its peer. If MedServer1 fails, its groups can fail over to MedServer2.

If LargeServer1 fails, the failover of the two groups running on it is serialized. The first group lexically, G1, chooses MedServer2 because the server meets the required Limits and has AvailableCapacity value. Group G2 chooses MedServer1 because it is the only remaining system that meets the required Limits.

Sample configuration: Server consolidation

The following configuration has a complex eight-node cluster running multiple applications and large databases. The database servers, LargeServer1, LargeServer2, and LargeServer3, are enterprise systems. The middle-tier servers running multiple applications are MedServer1, MedServer2, MedServer3, MedServer4, and MedServer5.

In this configuration, the database zone (system zone 0) can handle a maximum of two failures. Each server has Limits to support a maximum of three database service groups. The application zone has excess capacity built into each server.

The servers running the application groups specify Limits to support one database, even though the application groups do not run prerequisites. This allows a database to fail over across system zones and run on the least-loaded server in the application zone.

```
include "types.cf"
cluster SGWM-demo (
)

system LargeServer1 (
```

```
Capacity = 200
Limits = { ShrMemSeg=15, Semaphores=30, Processors=18 }
LoadWarningLevel = 80
LoadTimeThreshold = 900
)

system LargeServer2 (
    Capacity = 200
    Limits = { ShrMemSeg=15, Semaphores=30, Processors=18 }
    LoadWarningLevel=80
    LoadTimeThreshold=900
)

system LargeServer3 (
    Capacity = 200
    Limits = { ShrMemSeg=15, Semaphores=30, Processors=18 }
    LoadWarningLevel=80
    LoadTimeThreshold=900
)

system MedServer1 (
    Capacity = 100
    Limits = { ShrMemSeg=5, Semaphores=10, Processors=6 }
)

system MedServer2 (
    Capacity = 100
    Limits = { ShrMemSeg=5, Semaphores=10, Processors=6 }
)

system MedServer3 (
    Capacity = 100
    Limits = { ShrMemSeg=5, Semaphores=10, Processors=6 }
)

system MedServer4 (
    Capacity = 100
    Limits = { ShrMemSeg=5, Semaphores=10, Processors=6 }
)

system MedServer5 (
    Capacity = 100
    Limits = { ShrMemSeg=5, Semaphores=10, Processors=6 }
```



```
)

group Database1 (
    SystemList = { LargeServer1 = 0, LargeServer2 = 1,
                  LargeServer3 = 2, MedServer1 = 3,
                  MedServer2 = 4, MedServer3 = 5,
                  MedServer4 = 6, MedServer5 = 6 }
    SystemZones = { LargeServer1=0, LargeServer2=0,
LargeServer3=0,
                  MedServer1=1, MedServer2=1, MedServer3=1,
MedServer4=1,
                  MedServer5=1 }
    AutoStartPolicy = Load
    AutoStartList = { LargeServer1, LargeServer2, LargeServer3 }
    FailOverPolicy = Load
    Load = { Units = 100 }
    Prerequisites = { ShrMemSeg=5, Semaphores=10, Processors=6 }
)

group Database2 (
    SystemList = { LargeServer1 = 0, LargeServer2 = 1,
                  LargeServer3 = 2, MedServer1 = 3,
                  MedServer2 = 4, MedServer3 = 5,
                  MedServer4 = 6, MedServer5 = 6 }
    SystemZones = { LargeServer1=0, LargeServer2=0,
LargeServer3=0,
                  MedServer1=1, MedServer2=1, MedServer3=1,
MedServer4=1,
                  MedServer5=1 }
    AutoStartPolicy = Load
    AutoStartList = { LargeServer1, LargeServer2, LargeServer3 }
    FailOverPolicy = Load
    Load = { Units = 100 }
    Prerequisites = { ShrMemSeg=5, Semaphores=10, Processors=6 }
)

group Database3 (
    SystemList = { LargeServer1 = 0, LargeServer2 = 1,
                  LargeServer3 = 2, MedServer1 = 3,
                  MedServer2 = 4, MedServer3 = 5,
                  MedServer4 = 6, MedServer5 = 6 }
    SystemZones = { LargeServer1=0, LargeServer2=0,
LargeServer3=0,
```



```
Load = { Units = 50 }
)

group Application3 (
    SystemList = { LargeServer1 = 0, LargeServer2 = 1,
                  LargeServer3 = 2, MedServer1 = 3,
                  MedServer2 = 4, MedServer3 = 5,
                  MedServer4 = 6, MedServer5 = 6 }
    SystemZones = { LargeServer1=0, LargeServer2=0,
LargeServer3=0,
                  MedServer1=1, MedServer2=1, MedServer3=1,
MedServer4=1,
                  MedServer5=1 }
    AutoStartPolicy = Load
    AutoStartList = { MedServer1, MedServer2, MedServer3,
MedServer4,
                  MedServer5 }
    FailOverPolicy = Load
    Load = { Units = 50 }
)

group Application4 (
    SystemList = { LargeServer1 = 0, LargeServer2 = 1,
                  LargeServer3 = 2, MedServer1 = 3,
                  MedServer2 = 4, MedServer3 = 5,
                  MedServer4 = 6, MedServer5 = 6 }
    SystemZones = { LargeServer1=0, LargeServer2=0,
LargeServer3=0,
                  MedServer1=1, MedServer2=1, MedServer3=1,
MedServer4=1,
                  MedServer5=1 }
    AutoStartPolicy = Load
    AutoStartList = { MedServer1, MedServer2, MedServer3,
MedServer4,
                  MedServer5 }
    FailOverPolicy = Load
    Load = { Units = 50 }
)

group Application5 (
    SystemList = { LargeServer1 = 0, LargeServer2 = 1,
                  LargeServer3 = 2, MedServer1 = 3,
                  MedServer2 = 4, MedServer3 = 5,
```

```
        MedServer4 = 6, MedServer5 = 6 }
    SystemZones = { LargeServer1=0, LargeServer2=0,
LargeServer3=0,
        MedServer1=1, MedServer2=1, MedServer3=1,
MedServer4=1,
        MedServer5=1 }
    AutoStartPolicy = Load
    AutoStartList = { MedServer1, MedServer2, MedServer3,
MedServer4,
        MedServer5 }
    FailOverPolicy = Load
    Load = { Units = 50 }
)
```

About the AutoStart operation

Based on the preceding main.cf example, the AutoStart sequence resembles:

Database1	LargeServer1
Database2	LargeServer2
Database3	LargeServer3
Application1	MedServer1
Application2	MedServer2
Application3	MedServer3
Application4	MedServer4
Application5	MedServer5

About the normal operation

[Table 11-13](#) shows the normal operation cluster configuration for a complex eight-node cluster running multiple applications and large databases.

Table 11-13 Normal operation cluster configuration for a complex eight-node cluster running multiple applications and large databases

Server	Available capacity	Current limits	Online groups
LargeServer1	100	ShrMemSeg=10 Semaphores=20 Processors=12	Database1
LargeServer2	100	ShrMemSeg=10 Semaphores=20 Processors=12	Database2
LargeServer3	100	ShrMemSeg=10 Semaphores=20 Processors=12	Database3
MedServer1	50	ShrMemSeg=5 Semaphores=10 Processors=6	Application1
MedServer2	50	ShrMemSeg=5 Semaphores=10 Processors=6	Application2
MedServer3	50	ShrMemSeg=5 Semaphores=10 Processors=6	Application3
MedServer4	50	ShrMemSeg=5 Semaphores=10 Processors=6	Application4
MedServer5	50	ShrMemSeg=5 Semaphores=10 Processors=6	Application5

About the failure scenario

In the following example, LargeServer3 fails. VCS scans all available systems in the SystemList for the Database3 group for systems in the same SystemZone and

identifies systems that meet the group's prerequisites. In this case, LargeServer1 and LargeServer2 meet the required Limits. Database3 is brought online on LargeServer1. This results in the following configuration:

Table 11-14 shows the failure scenario for a complex eight-node cluster running multiple applications and large databases.

Table 11-14 Failure scenario for a complex eight-node cluster running multiple applications and large databases

Server	Available capacity	Current limits	Online groups
LargeServer1	0	ShrMemSeg=5 Semaphores=10 Processors=6	Database1 Database3
LargeServer2	100	ShrMemSeg=10 Semaphores=20 Processors=12	Database2

In this scenario, further failure of either system can be tolerated because each has sufficient Limits available to accommodate the additional service group.

About the cascading failure scenario

If the performance of a database is unacceptable with two database groups running on a single server, the SystemZones policy can help expedite performance. Failing over a database group into the application zone has the effect of resetting the group's preferred zone. For example, in the above scenario Database3 was moved to LargeServer1. The administrator could reconfigure the application zone to move two application groups to a single system. The database application can then be switched to the empty application server (MedServer1–MedServer5), which would put Database3 in Zone1 (application zone). If a failure occurs in Database3, the group selects the least-loaded server in the application zone for failover.

The role of service group dependencies

This chapter includes the following topics:

- [About service group dependencies](#)
- [Service group dependency configurations](#)
- [Frequently asked questions about group dependencies](#)
- [About linking service groups](#)
- [About linking multiple child service groups](#)
- [VCS behavior with service group dependencies](#)

About service group dependencies

Service groups can be dependent on each other. The dependent group is the parent and the other group is the child. For example a finance application (parent) may require that the database application (child) is online before it comes online. While service group dependencies offer more features to manage application service groups, they create more complex failover configurations.

A service group may function both as a parent and a child. In VCS, a dependency tree may be up to five levels deep.

About dependency links

The dependency relationship between a parent and a child is called a link. The link is characterized by the dependency category, the location of the service groups, and the rigidity of dependency.

- A dependency may be online, or offline.
- A dependency may be local, global, remote, or site.
- A dependency may be soft, firm, or hard with respect to the rigidity of the constraints between parent and child service group.

You can customize the behavior of service groups by choosing the right combination of the dependency category, location, and rigidity

Dependency categories

Dependency categories determine the relationship of the parent group with the state of the child group.

[Table 12-1](#) shows dependency categories and relationships between parent and child service groups.

Table 12-1 Dependency categories

Dependency	Relationship between parent and child service groups
<p>Online group dependency</p>	<p>The parent group must wait for the child group to be brought online before it can start.</p> <p>For example, to configure a database application and a database service as two separate groups, specify the database application as the parent, and the database service as the child.</p> <p>Online group dependency supports various location-based and rigidity-based combinations.</p>
<p>Offline group dependency</p>	<p>The parent group can be started only if the child group is offline and vice versa. This behavior prevents conflicting applications from running on the same system.</p> <p>For example, configure a test application as the parent and the production application as the child. The parent and child applications can be configured on the same system or on different systems.</p> <p>Offline group dependency supports only offline-local dependency.</p>

Dependency location

The relative location of the parent and child service groups determines whether the dependency between them is a local, global, remote or site.

[Table 12-2](#) shows the dependency locations for local, global, remote and site dependencies.

Table 12-2 Dependency location

Dependency	Relative location of the parent and child service groups
Local dependency	The parent group depends on the child group being online or offline on the same system.
Global dependency	An instance of the parent group depends on one or more instances of the child group being online on any system in the cluster.
Remote dependency	An instance of the parent group depends on one or more instances of the child group being online on any system in the cluster other than the system on which the parent is online.
Site dependency	An instance of the parent group depends on one or more instances of the child group being online on any system in the same site.

Dependency rigidity

The type of dependency defines the rigidity of the link between parent and child groups. A soft dependency means minimum constraints, whereas a hard dependency means maximum constraints.

[Table 12-3](#) shows dependency rigidity and associated constraints.

Table 12-3 Dependency rigidity

Dependency rigidity	Constraints between parent and child service groups
Soft dependency	<p>Specifies the minimum constraints while bringing parent and child groups online. The only constraint is that the child group must be online before the parent group is brought online.</p> <p>For example, in an online local soft dependency, an instance of the child group must be online on the same system before the parent group can come online.</p> <p>Soft dependency provides the following flexibility:</p> <ul style="list-style-type: none"> ■ If the child group faults, VCS does not immediately take the parent offline. If the child group cannot fail over, the parent remains online. ■ When both groups are online, either group, child or parent, may be taken offline while the other remains online. ■ If the parent group faults, the child group remains online. ■ When the link is created, the child group need not be online if the parent is online. However, when both groups are online, their online state must not conflict with the type of link.

Table 12-3 Dependency rigidity (*continued*)

Dependency rigidity	Constraints between parent and child service groups
Firm dependency	<p>Imposes more constraints when VCS brings the parent or child groups online or takes them offline. In addition to the constraint that the child group must be online before the parent group is brought online, the constraints include:</p> <ul style="list-style-type: none"> ■ If the child group faults, the parent is taken offline. If the parent is frozen at the time of the fault, the parent remains in its original state. If the child cannot fail over to another system, the parent remains offline. ■ If the parent group faults, the child group may remain online. ■ The child group cannot be taken offline if the parent group is online. The parent group can be taken offline while the child is online. ■ When the link is created, the parent group must be offline. However, if both groups are online, their online state must not conflict with the type of link.
Hard dependency	<p>Imposes the maximum constraints when VCS brings the parent of child service groups online or takes them offline. For example:</p> <ul style="list-style-type: none"> ■ If a child group faults, the parent is taken offline before the child group is taken offline. If the child group fails over, the parent fails over to another system (or the same system for a local dependency). If the child group cannot fail over, the parent group remains offline. ■ If the parent faults, the child is taken offline. If the child fails over, the parent fails over. If the child group cannot fail over, the parent group remains offline. <p>Note: When the child faults, if the parent group is frozen, the parent remains online. The faulted child does not fail over.</p> <p>The following restrictions apply when configuring a hard dependency:</p> <ul style="list-style-type: none"> ■ Only online local hard dependencies are supported. ■ Only a single-level, parent-child relationship can be configured as a hard dependency. ■ A child group can have only one online hard parent group. Likewise, a parent group can have only one online hard child group. ■ Bringing the child group online does not automatically bring the parent online. ■ Taking the parent group offline does not automatically take the child offline. ■ Bringing the parent online is prohibited if the child is offline. ■ Hard dependencies are allowed only at the bottommost level of dependency tree (leaf level).

About dependency limitations

Following are some service group dependency limitations:

- A group dependency tree may be at most five levels deep.
- You cannot link two service groups whose current states violate the relationship. For example, all link requests are accepted if all instances of parent group are offline.
All link requests are rejected if parent group is online and child group is offline, except in offline dependencies and in soft dependencies.
All online global link requests, online remote link requests, and online site link requests to link two parallel groups are rejected.
All online local link requests to link a parallel parent group to a failover child group are rejected.
- Linking service groups using site dependencies:
 - If the service groups to be linked are online on different sites, you cannot use site dependency to link them.
 - All link requests to link parallel or hybrid parent groups to a failover or hybrid child service group are rejected.
 - If two service groups are already linked using a local, site, remote, or global dependency, you must unlink the existing dependency and use site dependency. However, you can configure site dependency with other online dependencies in multiple child or multiple parent configurations.

Service group dependency configurations

In the following tables, the term instance applies to parallel groups only. If a parallel group is online on three systems, for example, an instance of the group is online on each system. For failover groups, only one instance of a group is online at any time. The default dependency type is Firm.

See [“Service group attributes”](#) on page 789.

About failover parent / failover child

[Table 12-4](#) shows service group dependencies for failover parent / failover child.

Table 12-4 Service group dependency configurations: Failover parent / Failover child

Link	Failover parent depends on ...	Failover parent is online If ...	If failover child faults, then ...	If failover parent faults, then ...
online local soft	Failover Child online on same system.	Child is online on same system.	Parent stays online. If Child fails over to another system, Parent migrates to the same system. If Child cannot fail over, Parent remains online.	Child stays online.
online local firm	Failover Child online on same system.	Child is online on same system.	Parent taken offline. If Child fails over to another system, Parent migrates to the same system. If Child cannot fail over, Parent remains offline.	Child stays online.
online local hard	Failover Child online on same system.	Child is online on same system.	Parents taken offline before Child is taken offline. If Child fails over to another system, Parent migrates to the same system. If Child cannot fail over, Parent remains offline.	Child taken offline. If Child fails over, Parent migrates to the same system. If Child cannot fail over, Parent remains offline.

Table 12-4 Service group dependency configurations: Failover parent / Failover child (*continued*)

Link	Failover parent depends on ...	Failover parent is online If ...	If failover child faults, then ...	If failover parent faults, then ...
online global soft	Failover Child online somewhere in the cluster.	Child is online somewhere in the cluster.	Parent stays online. If Child fails over to another system, Parent remains online. If Child cannot fail over, Parent remains online.	Child stays online. Parent fails over to any available system. If no failover target system is available, Parent remains offline.
online global firm	Failover Child online somewhere in the cluster.	Child is online somewhere in the cluster.	Parent taken offline after Child is taken offline. If Child fails over to another system, Parent is brought online on any system. If Child cannot fail over, Parent remains offline.	Child stays online. Parent fails over to any available system. If no failover target system is available, Parent remains offline.

Table 12-4 Service group dependency configurations: Failover parent / Failover child (*continued*)

Link	Failover parent depends on ...	Failover parent is online If ...	If failover child faults, then ...	If failover parent faults, then ...
online remote soft	Failover Child online on another system in the cluster.	Child is online on another system in the cluster.	<p>If Child fails over to the system on which Parent was online, Parent migrates to another system.</p> <p>If Child fails over to another system, Parent continues to run on original system.</p> <p>If Child cannot fail over, Parent remains online.</p>	<p>Child stays online.</p> <p>Parent fails over to a system where Child is not online.</p> <p>If the only system available is where Child is online, Parent is not brought online.</p> <p>If no failover target system is available, Child remains online.</p>
online remote firm	Failover Child online on another system in the cluster.	Child is online on another system in the cluster.	<p>If Child fails over to the system on which Parent was online, Parent switches to another system.</p> <p>If Child fails over to another system, Parent restarts on original system.</p> <p>If Child cannot fail over, VCS takes the parent offline.</p>	<p>Parent fails over to a system where Child is not online.</p> <p>If the only system available is where Child is online, Parent is not brought online.</p> <p>If no failover target system is available, Child remains online.</p>

Table 12-4 Service group dependency configurations: Failover parent / Failover child (*continued*)

Link	Failover parent depends on ...	Failover parent is online If ...	If failover child faults, then ...	If failover parent faults, then ...
online site soft	Failover Child online on same site.	Child is online in the same site.	<p>Parent stays online.</p> <p>If another Child instance is online or Child fails over to a system within the same site, Parent stays online.</p> <p>If Child fails over to a system in another site, parent migrates to another site where Child is online and depends on Child instance(s) in that site.</p> <p>If Child cannot fail over, Parent remains online.</p>	<p>Child remains online.</p> <p>Parent fails over to another system in the same site maintaining dependency on Child instances in the same site.</p> <p>If Parent cannot failover to a system within the same site, then Parent fails over to a system in another site where at least one instance of child is online in the same site.</p>

Table 12-4 Service group dependency configurations: Failover parent / Failover child (*continued*)

Link	Failover parent depends on ...	Failover parent is online If ...	If failover child faults, then ...	If failover parent faults, then ...
online site firm	Failover Child online in the same site	Child is online in the same site.	<p>Parent taken offline.</p> <p>If another instance of child is online in the same site or child fails over to another system in the same site, Parent migrates to a system in the same site.</p> <p>If no Child instance is online or Child cannot fail over, Parent remains offline.</p>	<p>Child remains online.</p> <p>Parent fails over to another system in same site maintaining dependence on Child instances in the same site.</p> <p>If Parent cannot failover to a system within same site, then Parent fails over to a system in another site where at least one instance of child is online.</p>

Table 12-4 Service group dependency configurations: Failover parent / Failover child (*continued*)

Link	Failover parent depends on ...	Failover parent is online If ...	If failover child faults, then ...	If failover parent faults, then ...
offline local	Failover Child offline on the same system	Child is offline on the same system.	<p>If Child fails over to the system on which parent is not running, parent continues running.</p> <p>If child fails over to system on which parent is running, parent switches to another system, if available.</p> <p>If no failover target system is available for Child to fail over to, Parent continues running.</p>	<p>Parent fails over to system on which Child is not online.</p> <p>If no failover target system is available, Child remains online.</p>

About failover parent / parallel child

With a failover parent and parallel child, no hard dependencies are supported.

[Table 12-5](#) shows service group dependency configurations for Failover parent / Parallel child.

Table 12-5 Service group dependency configurations: Failover parent / Parallel child

Link	Failover parent depends on ...	Failover parent is online if ...	If parallel child faults on a system, then ...	If failover parent faults, then ...
online local soft	Instance of parallel Child group on same system.	Instance of Child is online on same system.	If Child instance fails over to another system, the Parent also fails over to the same system. If Child instance cannot failover to another system, Parent remains online.	Parent fails over to other system and depends on Child instance there. Child Instance remains online where the Parent faulted.
online local firm	Instance of parallel Child group on same system.	Instance of Child is online on same system.	Parent is taken offline. Parent fails over to other system and depends on Child instance there.	Parent fails over to other system and depends on Child instance there. Child Instance remains online where Parent faulted.
online global soft	All instances of parallel Child group online in the cluster.	At least one instance of Child group is online somewhere in the cluster.	Parent remains online if Child faults on any system. If Child cannot fail over to another system, Parent remains online.	Parent fails over to another system, maintaining dependence on all Child instances.

Table 12-5 Service group dependency configurations: Failover parent / Parallel child (*continued*)

Link	Failover parent depends on ...	Failover parent is online if ...	If parallel child faults on a system, then ...	If failover parent faults, then ...
online global firm	One or more instances of parallel Child group remaining online	An instance of Child group is online somewhere in the cluster.	<p>Parent is taken offline.</p> <p>If another Child instance is online or Child fails over, Parent fails over to another system or the same system.</p> <p>If no Child instance is online or Child cannot fail over, Parent remains offline.</p>	Parent fails over to another system, maintaining dependence on all Child instances.
online remote soft	One or more instances parallel Child group remaining online on other systems.	One or more instances of Child group are online on other systems.	<p>Parent remains online.</p> <p>If Child fails over to the system on which Parent is online, Parent fails over to another system.</p>	Parent fails over to another system, maintaining dependence on the Child instances.

Table 12-5 Service group dependency configurations: Failover parent / Parallel child (*continued*)

Link	Failover parent depends on ...	Failover parent is online if ...	If parallel child faults on a system, then ...	If failover parent faults, then ...
online remote firm	All instances parallel Child group remaining online on other systems.	All instances of Child group are online on other systems.	Parent is taken offline. If Child fails over to the system on which Parent is online, Parent fails over to another system. If Child fails over to another system, Parent is brought online on its original system.	Parent fails over to another system, maintaining dependence on all Child instances.
online site soft	One or more instances of parallel Child group in the same site.	At least one instance of Child is online in same site.	Parent stays online if child is online on any system in the same site. If Child fails over to a system in another site, Parent stays in the same site. If Child cannot fail over, Parent remains online.	Child stays online. Parents fails over to a system with Child online in the same site. If the parent group cannot failover, child group remains online

Table 12-5 Service group dependency configurations: Failover parent / Parallel child (*continued*)

Link	Failover parent depends on ...	Failover parent is online if ...	If parallel child faults on a system, then ...	If failover parent faults, then ...
online site firm	One or more instances of parallel Child group in the same site.	At least one instance of Child is online in same site.	Parent stays online if any instance of child is online in the same site. If Child fails over to another system, Parent migrates to a system in the same site. If Child cannot fail over, Parent remains offline.	Child stays online. Parents fails over to a system with Child online in the same site. If the parent group cannot failover, child group remains online.
offline local	Parallel Child offline on same system.	No instance of Child is online on same system.	Parent remains online if Child fails over to another system. If Child fails over to the system on which Parent is online, Parent fails over.	Child remains online and parent fails over to another system where child is not online. If the parent group cannot failover, child group remains offline.

About parallel parent / failover child

Table 12-6 shows service group dependencies for parallel parent / failover child. Online local dependencies between parallel parent groups and failover child groups are not supported.

Table 12-6 Service group dependency configurations: Parallel parent / Failover child

Link	Parallel parent instances depend on ...	Parallel parent instances are online if ...	If failover child faults on a system, then ...	If parallel parent faults, then ...
online global soft	Failover Child group online somewhere in the cluster.	Failover Child is online somewhere in the cluster.	Parent remains online.	Child remains online
online global firm	Failover Child group somewhere in the cluster.	Failover Child is online somewhere in the cluster.	All instances of Parent taken offline. After Child fails over, Parent instances are failed over or restarted on the same systems.	Child stays online.
online remote soft	Failover Child group on another system.	Failover Child is online on another system.	If Child fails over to system on which Parent is online, Parent fails over to other systems. If Child fails over to another system, Parent remains online.	Child remains online. Parent tries to fail over to another system where child is not online.

Table 12-6 Service group dependency configurations: Parallel parent / Failover child (*continued*)

Link	Parallel parent instances depend on ...	Parallel parent instances are online if ...	If failover child faults on a system, then ...	If parallel parent faults, then ...
online remote firm	Failover Child group on another system.	Failover Child is online on another system.	<p>All instances of Parent taken offline.</p> <p>If Child fails over to system on which Parent was online, Parent fails over to other systems.</p> <p>If Child fails over to another system, Parent brought online on same systems.</p>	Child remains online. Parent tries to fail over to another system where child is not online.
offline local	Failover Child offline on same system.	Failover Child is not online on same system.	<p>Parent remains online if Child fails over to another system.</p> <p>Child fails over to another system. If Parent is online on that system, Parent is brought offline. Parent fails over to any other system.</p>	Child remains online.

About parallel parent / parallel child

Global and remote dependencies between parallel parent groups and parallel child groups are not supported.

Table 12-7 shows service group dependency configurations for parallel parent / parallel child.

Table 12-7 Service group dependency configurations: Parallel parent / Parallel child

Link	Parallel parent depends on ...	Parallel parent is online If ...	If parallel child faults, then ...	If parallel parent faults, then ...
online local soft	Parallel Child instance online on same system.	Parallel Child instance is online on same system.	If Child fails over to another system, Parent migrates to the same system as the Child. If Child cannot fail over, Parent remains online.	Child instance stays online. Parent instance can fail over only to system where Child instance is running and other instance of Parent is not running.
online local firm	Parallel Child instance online on same system.	Parallel Child instance is online on same system.	Parent taken offline. If Child fails over to another system, VCS brings an instance of the Parent online on the same system as Child. If Child cannot fail over, Parent remains offline.	Child stays online. Parent instance can fail over only to system where Child instance is running and other instance of Parent is not running.

Table 12-7 Service group dependency configurations: Parallel parent / Parallel child (*continued*)

Link	Parallel parent depends on ...	Parallel parent is online If ...	If parallel child faults, then ...	If parallel parent faults, then ...
offline local	Parallel Child offline on same system.	No instance of Child is online on same system.	Parent remains online if Child fails over to another system. Parent goes offline if Child fails over to a system where Parent is online. Parent fails over to another system where Child is not online.	Child remains online. Parent fails over to a system where Child is not online.

Frequently asked questions about group dependencies

[Table 12-8](#) lists some commonly asked questions about group dependencies.

Table 12-8 Frequently asked questions about group dependencies

Dependency	Frequently asked questions
Online local	Can child group be taken offline when parent group is online? Soft=Yes Firm=No Hard = No. Can parent group be switched while child group is online? Soft=No Firm=No Hard = No. Can child group be switched while parent group is online? Soft=No Firm=No Hard = No.

Table 12-8 Frequently asked questions about group dependencies
(continued)

Dependency	Frequently asked questions
Online global	<p>Can child group be taken offline when parent group is online? Soft=Yes Firm=No.</p> <p>Can parent group be switched while child group is running? Soft=Yes Firm=Yes.</p> <p>Can child group be switched while parent group is running? Soft=Yes Firm=No</p>
Online remote	<p>Can child group be taken offline when parent group is online? Soft=Yes Firm=No.</p> <p>Can parent group be switched while child group is running? Soft=Yes, but not to system on which child is running. Firm=Yes, but not to system on which child is running.</p> <p>Can child group be switched while parent group is running? Soft=Yes Firm=No, but not to system on which parent is running.</p>
Offline local	<p>Can parent group be brought online when child group is offline? Yes.</p> <p>Can child group be taken offline when parent group is online? Yes.</p> <p>Can parent group be switched while the child group is running? Yes, but not to system on which child is running.</p> <p>Can child group be switched while the parent group is running? Yes, but not to system on which parent is running.</p>
Online site	<p>Can child group be taken offline when parent group is online? Soft=Yes Firm=No.</p> <p>Can parent group be switched to a system in the same site while child group is running? Soft=Yes Firm=Yes.</p> <p>Can child group be switched while parent group is running? Soft=Yes Firm=No</p>

About linking service groups

Note that a configuration may require that a certain service group be running before another service group can be brought online. For example, a group containing resources of a database service must be running before the database application is brought online.

See [“Linking service groups”](#) on page 138.

Use the following command to link service groups from the command line

```
hagrpr -link parent_group child_group gd_category gd_location [gd_type]
```

<i>parent_group</i>	Name of the parent group
<i>child_group</i>	Name of the child group
<i>gd_category</i>	category of group dependency (online/offline).
<i>gd_location</i>	the scope of dependency (local/global/remote/site).
<i>gd_type</i>	type of group dependency (soft/firm/hard). Default is firm

About linking multiple child service groups

VCS lets you configure multiple child service groups for a single parent service group to depend on. For example, an application might depend on two or more databases.

Dependencies supported for multiple child service groups

Multiple child service groups can be linked to a parent service group using soft and firm type of dependencies. Hard dependencies and offline local dependencies are not supported

The supported dependency relationships between a parent service group and multiple child service groups include:

- Soft dependency
All child groups can be online local soft.
- Firm dependency
All child groups can be online local firm.
- A combination of soft and firm dependencies

Some child groups can be online local soft and other child groups can be online local firm.

- A combination of local, global, remote, and site dependencies
 One child group can be online local soft, another child group can be online remote soft, and yet another child group can be online global firm.

Dependencies not supported for multiple child service groups

Multiple child service groups *cannot* be linked to a parent service group using offline local and online local hard dependencies. Moreover, these dependencies *cannot* be used with other dependency types.

A few examples of dependency relationships that are *not* supported between a parent service group and multiple child service groups:

- A configuration in which multiple child service groups are offline local.
- A configuration in which multiple child service groups are online local hard.
- Any combination of offline local and other dependency types
 You cannot have a combination of offline local and online local soft or a combination of offline local and online local hard.
- Any combination of online local hard and other dependency types
 You cannot have a combination of online local hard and online local soft.

VCS behavior with service group dependencies

VCS enables or restricts service group operations to honor service group dependencies. VCS rejects operations if the operation violates a group dependency.

Online operations in group dependencies

Typically, bringing a child group online manually is never rejected, except under the following circumstances:

- For online local dependencies, if parent is online, a child group online is rejected for any system other than the system where parent is online.
- For online remote dependencies, if parent is online, a child group online is rejected for the system where parent is online.
- For offline local dependencies, if parent is online, a child group online is rejected for the system where parent is online.

The following examples describe situations where bringing a parallel child group online is accepted:

- For a parallel child group linked online local with failover/parallel parent, multiple instances of child group online are acceptable.
- For a parallel child group linked online remote with failover parent, multiple instances of child group online are acceptable, as long as child group does not go online on the system where parent is online.
- For a parallel child group linked offline local with failover/parallel parent, multiple instances of child group online are acceptable, as long as child group does not go online on the system where parent is online.

Offline operations in group dependencies

VCS rejects offline operations if the procedure violates existing group dependencies. Typically, firm dependencies are more restrictive to taking child group offline while parent group is online. Rules for manual offline include:

- Parent group offline is never rejected.
- For all soft dependencies, child group can go offline regardless of the state of parent group.
- For all firm dependencies, if parent group is online, child group offline is rejected.
- For the online local hard dependency, if parent group is online, child group offline is rejected.

Switch operations in group dependencies

Switching a service group implies manually taking a service group offline on one system, and manually bringing it back online on another system. VCS rejects manual switch if the group does not comply with the rules for offline or online operations.

Administration - Beyond the basics

- [Chapter 13. VCS event notification](#)
- [Chapter 14. VCS event triggers](#)
- [Chapter 15. Virtual Business Services](#)

VCS event notification

This chapter includes the following topics:

- [About VCS event notification](#)
- [Components of VCS event notification](#)
- [About VCS events and traps](#)
- [About monitoring aggregate events](#)
- [About configuring notification](#)

About VCS event notification

VCS provides a method for notifying important events such as resource or system faults to administrators or designated recipients. VCS includes a notifier component, which consists of the notifier process and the hanotify utility.

VCS supports SNMP consoles that can use an SNMP V2 MIB.

The notifier process performs the following tasks:

- Receives notifications from HAD
- Formats the notification
- Generates an SNMP (V2) trap or sends an email to the designated recipient, or does both.

If you have configured owners for resources, groups, or for the cluster, VCS also notifies owners of the events that affect their resources. A resource owner is notified of resource-related events, a group owner of group-related events, and so on.

You can also configure persons other than owners as recipients of notifications about events of a resource, resource type, service group, system, or cluster. The registered recipients get notifications for the events that have a severity level that

is equal to or greater than the level specified. For example, if you configure recipients for notifications and specify the severity level as Warning, VCS notifies the recipients about events with the severity levels Warning, Error, and SevereError but not about events with the severity level Information.

See [“About attributes and their definitions”](#) on page 763.

Figure 13-1 shows the severity levels of VCS events.

Table 13-1 VCS event severity levels

Severity level	Denotes
SevereError	Critical errors that can lead to data loss or corruption; SevereError is the highest severity level.
Error	Faults
Warning	Deviations from normal behavior
Information	Important events that exhibit normal behavior; Information is the lowest severity level.

Note: Severity levels are case-sensitive.

Figure 13-1 VCS event notification: Severity levels

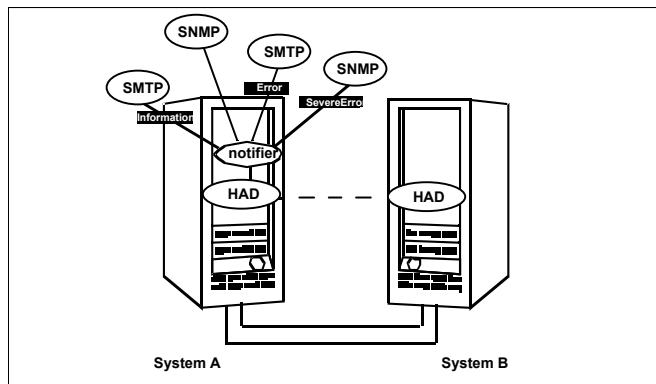

SNMP traps are forwarded to the SNMP console. Typically, traps are predefined for events such as service group or resource faults. You can use the hanotify utility to send additional traps.

Event messages and severity levels

When the VCS engine starts up, it queues all messages of severity Information and higher for later processing.

When notifier connects, it communicates to HAD the lowest severity threshold level currently defined for the SNMP option or for the SMTP option.

If notifier is started from the command line without specifying a severity level for the SNMP console or SMTP recipients, notifier communicates the default severity level Warning to HAD. If notifier is configured under VCS control, severity must be specified.

See the description of the NotifierMngr agent in the *Cluster Server Bundled Agents Reference Guide*.

For example, if the following severities are specified for notifier:

- Warning for email recipient 1
- Error for email recipient 2
- SevereError for SNMP console

Notifier communicates the minimum severity, Warning, to HAD, which then queues all messages labelled severity level Warning and greater.

Notifier ensures that recipients receive only the messages they are designated to receive according to the specified severity level. However, until notifier communicates the specifications to HAD, HAD stores all messages, because it does not know the severity the user has specified. This behavior prevents messages from being lost between the time HAD stores them and notifier communicates the specifications to HAD.

About persistent and replicated message queue

VCS includes a sophisticated mechanism for maintaining event messages, which ensures that messages are not lost. On each node, VCS queues messages to be sent to the notifier process. This queue is persistent as long as VCS is running and the contents of this queue remain the same on each node. If the notifier service group fails, notifier is failed over to another node in the cluster. Because the message queue is consistent across nodes, notifier can resume message delivery from where it left off even after failover.

How HAD deletes messages

The VCS engine, HAD, stores messages to be sent to notifier. After every 180 seconds, HAD tries to send all the pending notifications to notifier. When HAD receives an acknowledgement from notifier that a message is delivered to at least

one of the recipients, it deletes the message from its queue. For example, if two SNMP consoles and two email recipients are designated, notifier sends an acknowledgement to HAD even if the message reached only one of the four recipients. If HAD does not get acknowledgement for some messages, it keeps on sending these notifications to notifier after every 180 seconds till it gets an acknowledgement of delivery from notifier. An error message is printed to the log file when a delivery error occurs.

HAD deletes messages under the following conditions too:

- The message has been in the queue for time (in seconds) specified in MessageExpiryInterval attribute (default value: one hour) and notifier is unable to deliver the message to the recipient.
- The message queue is full and to make room for the latest message, the earliest message is deleted.

Components of VCS event notification

This topic describes the notifier process and the hanotify utility.

About the notifier process

The notifier process configures how messages are received from VCS and how they are delivered to SNMP consoles and SMTP servers. Using notifier, you can specify notification based on the severity level of the events generating the messages. You can also specify the size of the VCS message queue, which is 30 by default. You can change this value by modifying the MessageQueue attribute.

See the *Cluster Server Bundled Agents Reference Guide* for more information about this attribute.

When notifier is started from the command line, VCS does not control the notifier process. For best results, use the NotifierMngr agent that is bundled with VCS. Configure notifier as part of a highly available service group, which can then be monitored, brought online, and taken offline.

For information about the agent, see the *Cluster Server Bundled Agents Reference Guide*.

Note that notifier must be configured in a failover group, not parallel, because only one instance of notifier runs in the entire cluster. Also note that notifier does not respond to SNMP `get` or `set` requests; notifier is a trap generator only.

Notifier enables you to specify configurations for the SNMP manager and SMTP server, including machine names, ports, community IDs, and recipients' email

addresses. You can specify more than one manager or server, and the severity level of messages that are sent to each.

Note: If you start the notifier outside of VCS control, use the absolute path of the notifier in the command. VCS cannot monitor the notifier process if it is started outside of VCS control using a relative path.

Example of notifier command

Following is an example of a `notifier` command:

```
/opt/VRTSvcs/bin/notifier -s m=north -s  
m=south,p=2000,l=Error,c=your_company  
-t m=north,e="abc@your_company.com",l=SevereError
```

In this example, notifier:

- Sends all level SNMP traps to north at the default SNMP port and community value public.
- Sends Warning traps to north.
- Sends Error and SevereError traps to south at port 2000 and community value your_company.
- Sends SevereError email messages to north as SMTP server at default port and to email recipient abc@your_company.com.

About the hanotify utility

The hanotify utility enables you to construct user-defined messages. The utility forwards messages to HAD, which stores them in its internal message queue. Along with other messages, user-defined messages are also forwarded to the notifier process for delivery to email recipients, SNMP consoles, or both.

[Figure 13-2](#) shows the hanotify utility.

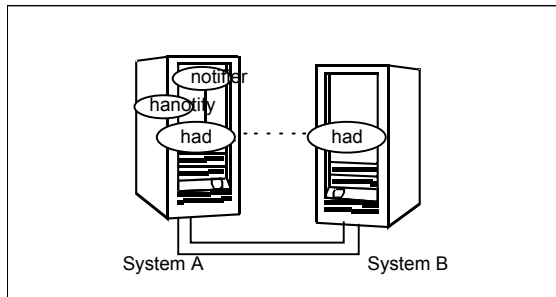
Figure 13-2 hanotify utility

Example of hanotify command

Following is an example of `hanotify` command:

```
hanotify -i 1.3.6.1.4.1.1302.3.8.10.2.8.0.10 -l Warning -n
agentres -T 7 -t "custom agent" -o 4 -S sys1 -L mv -p
sys2 -P mv -c MyAgent -C 7 -O johndoe -m "Custom message"
```

In this example, the number 1.3.6.1.4.1.1302.3.8.10.2.8.0.10 is the OID (Object Identifier) for the message being sent. Because it is a user-defined message, HAD has no way of knowing the OID associated with the SNMP trap corresponding to this message. Users must provide the OID.

The message severity level is set to Warning. The affected systems are `sys1` and `sys2`. Running this command generates a custom notification with the message "Custom message" for the resource `agentres`.

About VCS events and traps

This topic lists the events that generate traps, email notification, or both. Note that `SevereError` indicates the highest severity level, `Information` the lowest. Traps specific to global clusters are ranked from `Critical`, the highest severity, to `Normal`, the lowest.

Events and traps for clusters

[Table 13-2](#) shows events and traps for clusters.

Table 13-2 Events and traps for clusters

Event	Severity level	Description
Cluster has faulted.	Error	The cluster is down because of a fault.
Heartbeat is down. (Global Cluster Option)	Error	The connector on the local cluster lost its heartbeat connection to the remote cluster.
Remote cluster is in RUNNING state. (Global Cluster Option)	Information	Local cluster has complete snapshot of the remote cluster, indicating the remote cluster is in the RUNNING state.
Heartbeat is "alive." (Global Cluster Option)	Information	The heartbeat between clusters is healthy.
User has logged on to VCS.	Information	A user log on has been recognized because a user logged on by Cluster Manager, or because a <code>ha_{xxxx}</code> command was invoked.

Events and traps for agents

Table 13-3 depicts events and traps for agents.

Table 13-3 Events and traps for agents

Event	Severity level	Description
Agent is faulted.	Warning	The agent has faulted on one node in the cluster.
Agent is restarting	Information	VCS is restarting the agent.

Events and traps for resources

Table 13-4 depicts events and traps for resources.

Table 13-4 Events and traps for resources

Event	Severity level	Description
Resource state is unknown.	Warning	VCS cannot identify the state of the resource.
Resource monitoring has timed out.	Warning	Monitoring mechanism for the resource has timed out.
Resource is not going offline.	Warning	VCS cannot take the resource offline.
Health of cluster resource declined.	Warning	Used by agents to give additional information on the state of a resource. A decline in the health of the resource was identified during monitoring.
Resource went online by itself.	Warning (not for first probe)	The resource was brought online on its own.
Resource has faulted.	Error	The resource has faulted on one node in the cluster.
Resource is being restarted by agent.	Information	The agent is restarting the resource.
The health of cluster resource improved.	Information	Used by agents to give extra information about state of resource. An improvement in the health of the resource was identified during monitoring.

Table 13-4 Events and traps for resources (*continued*)

Event	Severity level	Description
Resource monitor time has changed.	Warning	<p>This trap is generated when statistical analysis for the time taken by the monitor function of an agent is enabled for the agent.</p> <p>See “VCS agent statistics” on page 667.</p> <p>This trap is generated when the agent framework detects a sudden change in the time taken to run the monitor function for a resource. The trap information contains details of:</p> <ul style="list-style-type: none"> ■ The change in time required to run the monitor function ■ The actual times that were compared to deduce this change.
Resource is in ADMIN_WAIT state.	Error	<p>The resource is in the admin_wait state.</p> <p>See “About controlling Clean behavior on resource faults” on page 429.</p>

Events and traps for systems

[Table 13-5](#) depicts events and traps for systems.

Table 13-5 Events and traps for systems

Event	Severity level	Description
VCS is being restarted by <code>hashadow</code> .	Warning	The <code>hashadow</code> process is restarting the VCS engine.
VCS is in jeopardy.	Warning	One node running VCS is in jeopardy.

Table 13-5 Events and traps for systems (*continued*)

Event	Severity level	Description
VCS is up on the first node in the cluster.	Information	VCS is up on the first node.
VCS has faulted.	SevereError	VCS is down because of a fault.
A node running VCS has joined cluster.	Information	The cluster has a new node that runs VCS.
VCS has exited manually.	Information	VCS has exited gracefully from one node on which it was previously running.
CPU usage exceeded threshold on the system.	Warning	The system's CPU usage exceeded the Warning threshold level set in the CPUThreshold attribute.
Swap usage exceeded threshold on the system.	Warning	The system's swap usage exceeded the Warning threshold level set in the SwapThreshold attribute.
Memory usage exceeded threshold on the system.	Warning	The system's Memory usage exceeded the Warning threshold level set in the MemThresholdLevel attribute.

Events and traps for service groups

[Table 13-6](#) depicts events and traps for service groups.

Table 13-6 Events and traps for service groups

Event	Severity level	Description
Service group has faulted.	Error	The service group is offline because of a fault.

Table 13-6 Events and traps for service groups (*continued*)

Event	Severity level	Description
Service group concurrency violation.	SevereError	A failover service group has become online on more than one node in the cluster.
Service group has faulted and cannot be failed over anywhere.	SevereError	Specified service group faulted on all nodes where group could be brought online. There are no nodes to which the group can fail over.
Service group is online	Information	The service group is online.
Service group is offline.	Information	The service group is offline.
Service group is autodisabled.	Information	VCS has autodisabled the specified group because one node exited the cluster.
Service group is restarting.	Information	The service group is restarting.
Service group is being switched.	Information	VCS is taking the service group offline on one node and bringing it online on another.
Service group restarting in response to persistent resource going online.	Information	The service group is restarting because a persistent resource recovered from a fault.
The global service group is online/partial on multiple clusters. (Global Cluster Option)	SevereError	A concurrency violation occurred for the global service group.
Attributes for global service groups are mismatched. (Global Cluster Option)	Error	The attributes ClusterList, AutoFailOver, and Parallel are mismatched for the same global service group on different clusters.

SNMP-specific files

VCS includes two SNMP-specific files: `vcs.mib` and `vcs_trapd`, which are created in:

`/etc/VRTSvcs/snmp`

The file `vcs.mib` is the textual MIB for built-in traps that are supported by VCS. Load this MIB into your SNMP console to add it to the list of recognized traps.

The file `vcs_trapd` is specific to the HP OpenView Network Node Manager (NNM) SNMP console. The file includes sample events configured for the built-in SNMP traps supported by VCS. To merge these events with those configured for SNMP traps:

```
xnmevents -merge vcs_trapd
```

When you merge events, the SNMP traps sent by VCS by way of notifier are displayed in the HP OpenView NNM SNMP console.

Note: For more information on `xnmevents`, see the HP OpenView documentation.

Trap variables in VCS MIB

Traps sent by VCS are reversible to SNMPv2 after an SNMPv2 to SNMPv1 conversion.

For reversible translations between SNMPv1 and SNMPv2 trap PDUs, the second-last ID of the SNMP trap OID must be zero. This ensures that once you make a forward translation (SNMPv2 trap to SNMPv1; RFC 2576 Section 3.2), the reverse translation (SNMPv1 trap to SNMPv2 trap; RFC 2576 Section 3.1) is accurate.

The VCS notifier follows this guideline by using OIDs with second-last ID as zero, enabling reversible translations.

About severityId

This variable indicates the severity of the trap being sent.

[Table 13-7](#) shows the values that the variable `severityId` can take.

Table 13-7 Possible values of the variable `severityId`

Severity level and description	Value in trap PDU
Information Important events exhibiting normal behavior	0
Warning Deviation from normal behavior	1

Table 13-7 Possible values of the variable severityId (*continued*)

Severity level and description	Value in trap PDU
Error A fault	2
Severe Error Critical error that can lead to data loss or corruption	3

EntityType and entitySubType

These variables specify additional information about the entity.

[Table 13-8](#) shows the variables entityType and entitySubType.

Table 13-8 Variables entityType and entitySubType

Entity type	Entity sub-type
Resource	String. For example, disk.
Group	String The type of the group (failover or parallel)
System	String. For example, AIX 5.1.
Heartbeat	String Type of the heartbeat
VCS	String
GCO	String
Agent name	String The agent name

About entityState

This variable describes the state of the entity.

[Table 13-9](#) shows the the various states.

Table 13-9 Possible states

Entity	States
VCS states	<ul style="list-style-type: none"> ■ User has logged into VCS ■ Cluster has faulted ■ Cluster is in RUNNING state
Agent states	<ul style="list-style-type: none"> ■ Agent is restarting ■ Agent has faulted
Resources states	<ul style="list-style-type: none"> ■ Resource state is unknown ■ Resource monitoring has timed out ■ Resource is not going offline ■ Resource is being restarted by agent ■ Resource went online by itself ■ Resource has faulted ■ Resource is in admin wait state ■ Resource monitor time has changed
Service group states	<ul style="list-style-type: none"> ■ Service group is online ■ Service group is offline ■ Service group is auto disabled ■ Service group has faulted ■ Service group has faulted and cannot be failed over anywhere ■ Service group is restarting ■ Service group is being switched ■ Service group concurrency violation ■ Service group is restarting in response to persistent resource going online ■ Service group attribute value does not match corresponding remote group attribute value ■ Global group concurrency violation
System states	<ul style="list-style-type: none"> ■ VCS is up on the first node in the Cluster ■ VCS is being restarted by hashadow ■ VCS is in jeopardy ■ VCS has faulted ■ A node running VCS has joined cluster ■ VCS has exited manually ■ CPU usage exceeded the threshold on the system ■ Memory usage exceeded the threshold on the system ■ Swap usage exceeded the threshold on the system

Table 13-9 Possible states (*continued*)

Entity	States
GCO heartbeat states	<ul style="list-style-type: none">Cluster has lost heartbeat with remote clusterHeartbeat with remote cluster is alive

About monitoring aggregate events

This topic describes how you can detect aggregate events by monitoring individual notifications.

How to detect service group failover

VCS does not send any explicit traps when a failover occurs in response to a service group fault. When a service group faults, VCS generates the following notifications if the `AutoFailOver` attribute for the service group is set to 1:

- Service Group Fault for the node on which the service group was online and faulted
- Service Group Offline for the node on which the service group faulted
- Service Group Online for the node to which the service group failed over

How to detect service group switch

When a service group is switched, VCS sends a notification of severity Information to indicate the following events:

- Service group is being switched.
- Service group is offline for the node from which the service group is switched.
- Service group is online for the node to which the service group was switched. This notification is sent after VCS completes the service group switch operation.

Note: You must configure appropriate severity for the notifier to receive these notifications. To receive VCS notifications, the minimum acceptable severity level is Information.

About configuring notification

Configuring notification involves creating a resource for the Notifier Manager (NotifierMgr) agent in the ClusterService group.

See the *Cluster Server Bundled Agents Reference Guide* for more information about the agent.

VCS provides several methods for configuring notification:

- Manually editing the main.cf file.
- Using the Notifier wizard.
See [“Setting up VCS event notification by using the Notifier wizard”](#) on page 165.

VCS event triggers

This chapter includes the following topics:

- [About VCS event triggers](#)
- [Using event triggers](#)
- [List of event triggers](#)

About VCS event triggers

Triggers let you invoke user-defined scripts for specified events in a cluster.

VCS determines if the event is enabled and invokes the `hatrigger` script. The script is located at:

```
$VCS_HOME/bin/hatrigger
```

VCS also passes the name of the event trigger and associated parameters. For example, when a service group comes online on a system, VCS invokes the following command:

```
hatrigger -postonline system service_group
```

VCS does not wait for the trigger to complete execution. VCS calls the trigger and continues normal operation.

VCS invokes event triggers on the system where the event occurred, with the following exceptions:

- VCS invokes the `sysoffline` and `nofailover` event triggers on the lowest-numbered system in the `RUNNING` state.
- VCS invokes the `violation` event trigger on all systems on which the service group was brought partially or fully online.

By default, the `hatrigger` script invokes the trigger script(s) from the default path `$VCS_HOME/bin/triggers`. You can customize the trigger path by using the `TriggerPath` attribute.

See “[Resource attributes](#)” on page 764.

See “[Service group attributes](#)” on page 789.

The same path is used on all nodes in the cluster. The trigger path must exist on all the cluster nodes. On each cluster node, the trigger scripts must be installed in the trigger path.

Using event triggers

VCS provides a sample Perl script for each event trigger at the following location:

`$VCS_HOME/bin/sample_triggers/VRTSvcs`

Customize the scripts according to your requirements: you may choose to write your own Perl scripts.

To use an event trigger

- 1 Use the sample scripts to write your own custom actions for the trigger.
- 2 Move the modified trigger script to the following path on each node:
`$VCS_HOME/bin/triggers`
- 3 Configure other attributes that may be required to enable the trigger. See the usage information for the trigger for more information.

Performing multiple actions using a trigger

To perform multiple actions by using a trigger, specify the actions in the following format:

TNumService

Example: `T1clear_env, T2update_env, T5backup`

VCS executes the scripts in the ascending order of *Tnum*. The actions must be placed inside a directory whose name is the trigger name. For example, to perform multiple actions for the `postonline` trigger, place the scripts in a directory named `postonline`.

Note: As a good practice, ensure that one script does not affect the functioning of another script. If `script2` takes the output of `script1` as an input, `script2` must be capable of handling any exceptions that arise out of the behavior of `script1`.

Warning: Do not install customized trigger scripts in the `$VCS_HOME/bin/sample_triggers/VRTSvcs` directory or in the `$VCS_HOME/bin/internal_triggers` directory. If you install customized triggers in these directories, you might face issues while upgrading VCS.

List of event triggers

The information in the following sections describes the various event triggers, including their usage, parameters, and location.

About the dumptunables trigger

The following table describes the dumptunables event trigger:

Description	<p>The dumptunables trigger is invoked when HAD goes into the RUNNING state. When this trigger is invoked, it uses the HAD environment variables that it inherited, and other environment variables to process the event. Depending on the value of the <code>to_log</code> parameter, the trigger then redirects the environment variables to either stdout or the engine log.</p> <p>This trigger is not invoked when HAD is restarted by hashadow.</p> <p>This event trigger is internal and non-configurable.</p>
Usage	<pre>-dumptunables <i>triggertype</i> <i>system</i> <i>to_log</i></pre> <p><i>triggertype</i>—represents whether trigger is custom (<i>triggertype</i>=0) or internal (<i>triggertype</i>=1).</p> <p>For this trigger, <i>triggertype</i>=0.</p> <p><i>system</i>—represents the name of the system on which the trigger is invoked.</p> <p><i>to_log</i>—represents whether the output is redirected to engine log (<i>to_log</i>=1) or stdout (<i>to_log</i>=0).</p>

About the globalcounter_not_updated trigger

The following table describes the globalcounter_not_updated event trigger:

Description	<p>On the system having lowest NodeId in the cluster, VCS periodically broadcasts an update of GlobalCounter. If a node does not receive the broadcast for an interval greater than CounterMissTolerance, it invokes the globalcounter_not_updated trigger if CounterMissAction is set to Trigger. This event is considered critical since it indicates a problem with underlying cluster communications or cluster interconnects. Use this trigger to notify administrators of the critical events.</p>
-------------	--

Usage `-globalcounter_not_updated triggertype system_name
global_counter`

triggertype—represents whether trigger is custom (*triggertype*=0) or internal (*triggertype*=1).

For this trigger, *triggertype*=0.

system—represents the system which did not receive the update of GlobalCounter.

global_counter—represents the value of GlobalCounter.

About the injeopardy event trigger

The following table describes the injeopardy event trigger:

Description	<p>Invoked when a system is in jeopardy. Specifically, this trigger is invoked when a system has only one remaining link to the cluster, and that link is a network link (LLT). This event is considered critical because if the system loses the remaining network link, VCS does not fail over the service groups that were online on the system. Use this trigger to notify the administrator of the critical event. The administrator can then take appropriate action to ensure that the system has at least two links to the cluster.</p> <p>This event trigger is non-configurable.</p>
Usage	<p><code>-injeopardy <i>triggertype</i> <i>system</i> <i>system_state</i></code></p> <p><i>triggertype</i>—represents whether trigger is custom (<i>triggertype</i>=0) or internal (<i>triggertype</i>=1).</p> <p>For this trigger, <i>triggertype</i>=0.</p> <p><i>system</i>—represents the name of the system.</p> <p><i>system_state</i>—represents the value of the State attribute.</p>

About the loadwarning event trigger

The following table describes the loadwarning event trigger:

Description	<p>Invoked when a system becomes overloaded because the load of the system's online groups exceeds the system's <code>LoadWarningLevel</code> attribute for an interval exceeding the <code>LoadTimeThreshold</code> attribute.</p> <p>For example, assume that the <code>Capacity</code> is 150, the <code>LoadWarningLevel</code> is 80, and the <code>LoadTimeThreshold</code> is 300. Also, the sum of the <code>Load</code> attribute for all online groups on the system is 135. Because the <code>LoadWarningLevel</code> is 80, safe load is $0.80 * 150 = 120$. The trigger is invoked if the system load stays at 135 for more than 300 seconds because the actual load is above the limit of 120 specified by <code>LoadWarningLevel</code>.</p> <p>Use this trigger to notify the administrator of the critical event. The administrator can then switch some service groups to another system, ensuring that no one system is overloaded.</p> <p>This event trigger is non-configurable.</p>
Usage	<pre>-loadwarning <i>triggertype</i> <i>system</i> <i>available_capacity</i></pre> <p><i>triggertype</i>—represents whether trigger is custom (<i>triggertype</i>=0) or internal (<i>triggertype</i>=1).</p> <p>For this trigger, <i>triggertype</i>=0.</p> <p><i>system</i>—represents the name of the system.</p> <p><i>available_capacity</i>—represents the system's <code>AvailableCapacity</code> attribute. (<code>AvailableCapacity</code>=<code>Capacity</code>-sum of <code>Load</code> for system's online groups.)</p>

About the multinicb event trigger

The following table describes the multinicb event trigger:

Description	<p>Invoked when a network device that is configured as a MultiNICB resource changes its state. The trigger is also always called in the first monitor cycle.</p> <p>VCS provides a sample trigger script for your reference. You can customize the sample script according to your requirements.</p>
-------------	--

Usage	<pre>-multinicb_postchange <i>triggertype</i> <i>resource-name</i> <i>device-name</i> <i>previous-state</i> <i>current-state</i> monitor_heartbeat</pre> <p><i>triggertype</i>—represents whether trigger is custom (<i>triggertype</i>=0) or internal (<i>triggertype</i>=1).</p> <p>For this trigger, <i>triggertype</i>=0.</p> <p><i>resource-name</i>—represents the MultiNICB resource that invoked this trigger.</p> <p><i>device-name</i>—represents the network interface device for which the trigger is called.</p> <p><i>previous-state</i>—represents the state of the device before the change. The value 1 indicates that the device is up; 0 indicates it is down.</p> <p><i>current-state</i>—represents the state of the device after the change.</p> <p><i>monitor-heartbeat</i>—an integer count, which is incremented in every monitor cycle. The value 0 indicates that the monitor routine is called for first time.</p>
-------	--

About the nofailover event trigger

The following table describes the nofailover event trigger:

Description	<p>Called from the lowest-numbered system in RUNNING state when a service group cannot fail over.</p> <p>This event trigger is non-configurable.</p>
Usage	<pre>-nofailover <i>triggertype</i> <i>system</i> <i>service_group</i></pre> <p><i>triggertype</i>—represents whether trigger is custom (<i>triggertype</i>=0) or internal (<i>triggertype</i>=1).</p> <p>For this trigger, <i>triggertype</i>=0.</p> <p><i>system</i>—represents the name of the last system on which an attempt was made to bring the service group online.</p> <p><i>service_group</i>—represents the name of the service group.</p>

About the postoffline event trigger

The following table describes the postoffline event trigger:

Description	<p>This event trigger is invoked on the system where the group went offline from a partial or fully online state. This trigger is invoked when the group faults, or is taken offline manually.</p> <p>This event trigger is non-configurable.</p>
Usage	<pre>-postoffline <i>triggertype</i> <i>system</i> <i>service_group</i></pre> <p><i>triggertype</i>—represents whether trigger is custom (<i>triggertype</i>=0) or internal (<i>triggertype</i>=1).</p> <p>For this trigger, <i>triggertype</i>=0.</p> <p><i>system</i>—represents the name of the system.</p> <p><i>service_group</i>—represents the name of the service group that went offline.</p>

About the postonline event trigger

The following table describes the postonline event trigger:

Description	<p>This event trigger is invoked on the system where the group went online from an offline state.</p> <p>This event trigger is non-configurable.</p>
Usage	<pre>-postonline <i>triggertype</i> <i>system</i> <i>service_group</i></pre> <p><i>triggertype</i>—represents whether trigger is custom (<i>triggertype</i>=0) or internal (<i>triggertype</i>=1).</p> <p>For this trigger, <i>triggertype</i>=0.</p> <p><i>system</i>—represents the name of the system.</p> <p><i>service_group</i>—represents the name of the service group that went online.</p>

About the preonline event trigger

The following table describes the preonline event trigger:

Description	<p>Indicates when the HAD should call a user-defined script before bringing a service group online in response to the <code>hagrp -online</code> command or a fault.</p> <p>If the trigger does not exist, VCS continues to bring the group online. If the script returns 0 without an exit code, VCS runs the <code>hagrp -online -nopre</code> command, with the <code>-checkpartial</code> option if appropriate.</p> <p>If you do want to bring the group online, define the trigger to take no action. This event trigger is configurable.</p>
Usage	<pre>-preonline <i>triggertype</i> <i>system</i> <i>service_group</i> <i>whyonlining</i> [<i>system_where_group_faulted</i>]</pre> <p><i>triggertype</i>—represents whether trigger is custom (<i>triggertype</i>=0) or internal (<i>triggertype</i>=1).</p> <p>For this trigger, <i>triggertype</i>=0.</p> <p><i>system</i>—represents the name of the system.</p> <p><i>service_group</i>—represents the name of the service group on which the <code>hagrp</code> command was issued or the fault occurred.</p> <p><i>whyonlining</i>—represents three values:</p> <p>FAULT: Indicates that the group was brought online in response to a group failover.</p> <p>MANUAL: Indicates that group was brought online or switched manually on the system that is represented by the variable <i>system</i>.</p> <p>SYSFAULT: Indicates that the group was brought online in response to a sytem fault.</p> <p><i>system_where_group_faulted</i>—represents the name of the system on which the group has faulted or switched. This variable is optional and set when the engine invokes the trigger during a failover or switch.</p>
To enable the trigger	<p>Set the PreOnline attribute in the service group definition to 1.</p> <p>You can set a local (per-system) value for the attribute to control behavior on each node in the cluster.</p>
To disable the trigger	<p>Set the PreOnline attribute in the service group definition to 0.</p> <p>You can set a local (per-system) value for the attribute to control behavior on each node in the cluster.</p>

About the resadminwait event trigger

The following table describes the resadminwait event trigger:

Description	<p>Invoked when a resource enters ADMIN_WAIT state.</p> <p>When VCS sets a resource in the ADMIN_WAIT state, it invokes the resadminwait trigger according to the reason the resource entered the state.</p> <p>See “Clearing resources in the ADMIN_WAIT state” on page 430.</p> <p>This event trigger is non-configurable.</p>
Usage	<pre>-resadminwait system resource adminwait_reason</pre> <p><i>system</i>—represents the name of the system.</p> <p><i>resource</i>—represents the name of the faulted resource.</p> <p><i>adminwait_reason</i>—represents the reason the resource entered the ADMIN_WAIT state. Values range from 0-5:</p> <ul style="list-style-type: none">0 = The offline function did not complete within the expected time.1 = The offline function was ineffective.2 = The online function did not complete within the expected time.3 = The online function was ineffective.4 = The resource was taken offline unexpectedly.5 = The monitor function consistently failed to complete within the expected time.

About the resfault event trigger

The following table describes the resfault event trigger:

Description	<p>Invoked on the system where a resource has faulted. Note that when a resource is faulted, resources within the upward path of the faulted resource are also brought down.</p> <p>This event trigger is configurable.</p> <p>To configure this trigger, you must define the following:</p> <p>TriggerResFault: Set the attribute to 1 to invoke the trigger when a resource faults.</p>
-------------	---

Usage	<pre>-resfault <i>triggertype</i> <i>system</i> <i>resource</i> <i>previous_state</i></pre> <p><i>triggertype</i>—represents whether trigger is custom (<i>triggertype</i>=0) or internal (<i>triggertype</i>=1).</p> <p>For this trigger, <i>triggertype</i>=0.</p> <p><i>system</i>—represents the name of the system.</p> <p><i>resource</i>—represents the name of the faulted resource.</p> <p><i>previous_state</i>—represents the resource's previous state.</p>
To enable the trigger	To invoke the trigger when a resource faults, set the TriggerResFault attribute to 1.

About the resnotoff event trigger

The following table describes the resnotoff event trigger:

Description	<p>Invoked on the system if a resource in a service group does not go offline even after issuing the offline command to the resource.</p> <p>This event trigger is configurable.</p> <p>To configure this trigger, you must define the following:</p> <p>Resource Name Define resources for which to invoke this trigger by entering their names in the following line in the script: <code>@resources = ("resource1", "resource2");</code></p> <p>If any of these resources do not go offline, the trigger is invoked with that resource name and system name as arguments to the script.</p>
Usage	<pre>-resnotoff <i>triggertype</i> <i>system</i> <i>resource</i></pre> <p><i>triggertype</i>—represents whether trigger is custom (<i>triggertype</i>=0) or internal (<i>triggertype</i>=1).</p> <p>For this trigger, <i>triggertype</i>=0.</p> <p><i>system</i>—represents the system on which the resource is not going offline.</p> <p><i>resource</i>—represents the name of the resource.</p>

About the resrestart event trigger

The following table describes the resrestart event trigger.

Description	This trigger is invoked when a resource is restarted by an agent because resource faulted and RestartLimit was greater than 0.
-------------	--

Usage `-resrestart triggertype system resource`

triggertype—represents whether trigger is custom (*triggertype*=0) or internal (*triggertype*=1).

For this trigger, *triggertype*=0.

system—represents the name of the system.

resource—represents the name of the resource.

To enable the trigger This event trigger is not enabled by default. You must enable `resrestart` by setting the attribute `TriggerResRestart` to 1 in the `main.cf` file, or by issuing the command:

```
hagrp -modify service_group TriggerResRestart 1
```

However, the attribute is configurable at the resource level. To enable `resrestart` for a particular resource, you can set the attribute `TriggerResRestart` to 1 in the `main.cf` file or issue the command:

```
hares -modify resource TriggerResRestart 1
```

About the `resstatechange` event trigger

The following table describes the `resstatechange` event trigger:

Description	<p>This trigger is invoked under the following conditions:</p> <ul style="list-style-type: none"> Resource goes from OFFLINE to ONLINE. Resource goes from ONLINE to OFFLINE. Resource goes from ONLINE to FAULTED. Resource goes from FAULTED to OFFLINE. (When fault is cleared on non-persistent resource.) Resource goes from FAULTED to ONLINE. (When faulted persistent resource goes online or faulted non-persistent resource is brought online outside VCS control.) Resource is restarted by an agent because resource faulted and <code>RestartLimit</code> was greater than 0. <p>Warning: In later releases, you cannot use <code>resstatechange</code> to indicate restarting of a resource. Instead, use <code>resrestart</code>. See “About the <code>resrestart</code> event trigger” on page 524.</p> <p>This event trigger is configurable.</p>
-------------	---

Usage	<pre>-resstatechange <i>triggertype</i> <i>system</i> <i>resource</i> <i>previous_state</i> <i>new_state</i></pre> <p><i>triggertype</i>—represents whether trigger is custom (<i>triggertype</i>=0) or internal (<i>triggertype</i>=1).</p> <p>For this trigger, <i>triggertype</i>=0.</p> <p><i>system</i>—represents the name of the system.</p> <p><i>resource</i>—represents the name of the resource.</p> <p><i>previous_state</i>—represents the resource's previous state.</p> <p><i>new_state</i>—represents the resource's new state.</p>
To enable the trigger	<p>This event trigger is not enabled by default. You must enable <code>resstatechange</code> by setting the attribute <code>TriggerResStateChange</code> to 1 in the <code>main.cf</code> file, or by issuing the command:</p> <pre>hagrp -modify <i>service_group</i> TriggerResStateChange 1</pre> <p>Use the <code>resstatechange</code> trigger carefully. For example, enabling this trigger for a service group with 100 resources means that 100 <code>hatrigger</code> processes and 100 <code>resstatechange</code> processes are fired each time the group is brought online or taken offline. Also, this is not a "wait-mode" trigger. Specifically, VCS invokes the trigger and does not wait for trigger to return to continue operation.</p> <p>However, the attribute is configurable at the resource level. To enable <code>resstatechange</code> for a particular resource, you can set the attribute <code>TriggerResStateChange</code> to 1 in the <code>main.cf</code> file or issue the command:</p> <pre>hares -modify <i>resource</i> TriggerResStateChange 1</pre>

About the sysoffline event trigger

The following table describes the `sysoffline` event trigger:

Description	<p>Called from the lowest-numbered system in RUNNING state when a system is in jeopardy state or leaves the cluster.</p> <p>This event trigger is non-configurable.</p>
Usage	<pre>-sysoffline <i>system</i> <i>system_state</i></pre> <p><i>system</i>—represents the name of the system.</p> <p><i>system_state</i>—represents the value of the State attribute.</p> <p>See “System states” on page 760.</p>

About the sysup trigger

The following table describes the sysup event trigger:

Description The sysup trigger is invoked when the first node joins the cluster.

Usage `-sysup triggertype system systemstate`

For this trigger, *triggertype* = 0.

system—represents the system name.

systemstate—represents the state of the system.

About the sysjoin trigger

The following table describes the sysjoin event trigger:

Description The sysjoin trigger is invoked when a peer node joins the cluster.

Usage `-sysjoin triggertype system systemstate`

For this trigger, *triggertype* = 0.

system—represents the system name.

systemstate—represents the state of the system.

About the unable_to_restart_agent event trigger

The following table describes the unable_to_restart_agent event trigger:

Description This trigger is invoked when an agent faults more than a predetermined number of times within an hour. When this occurs, VCS gives up trying to restart the agent. VCS invokes this trigger on the node where the agent faults.

You can use this trigger to notify the administrators that an agent has faulted, and that VCS is unable to restart the agent. The administrator can then take corrective action.

Usage `-unable_to_restart_agent system resource_type`

system—represents the name of the system.

resource_type—represents the resource type associated with the agent.

To disable the trigger Remove the files associated with the trigger from the `$VCS_HOME/bin/triggers` directory.

About the `unable_to_restart_had` event trigger

The following table describes the `unable_to_restart_had` event trigger:

Description	<p>This event trigger is invoked by hashadow when hashadow cannot restart HAD on a system. If HAD fails to restart after six attempts, hashadow invokes the trigger on the system.</p> <p>The default behavior of the trigger is to reboot the system. However, service groups previously running on the system are auto-disabled when hashadow fails to restart HAD. Before these service groups can be brought online elsewhere in the cluster, you must autoenable them on the system. To do so, customize the <code>unable_to_restart_had</code> trigger to remotely execute the following command from any node in the cluster where VCS is running:</p> <pre>hagrp -autoenable <i>service_group</i> -sys <i>system</i></pre> <p>For example, if hashadow fails to restart HAD on <i>system1</i>, and if <i>group1</i> and <i>group2</i> were online on that system, a trigger customized in this manner would autoenable <i>group1</i> and <i>group2</i> on <i>system1</i> before rebooting. Autoenabling <i>group1</i> and <i>group2</i> on <i>system1</i> enables these two service groups to come online on another system when the trigger reboots <i>system1</i>.</p> <p>This event trigger is non-configurable.</p>
Usage	<pre>-unable_to_restart_had</pre> <p>This trigger has no arguments.</p>

About the violation event trigger

The following table describes the violation event trigger:

Description	<p>This trigger is invoked only on the system that caused the concurrency violation. Specifically, it takes the service group offline on the system where the trigger was invoked. Note that this trigger applies to failover groups only. The default trigger takes the service group offline on the system that caused the concurrency violation.</p> <p>This event trigger is internal and non-configurable.</p>
Usage	<pre>-violation <i>system</i> <i>service_group</i></pre> <p><i>system</i>—represents the name of the system.</p> <p><i>service_group</i>—represents the name of the service group that was fully or partially online.</p>

Virtual Business Services

This chapter includes the following topics:

- [About Virtual Business Services](#)
- [Features of Virtual Business Services](#)
- [Sample virtual business service configuration](#)
- [About choosing between VCS and VBS level dependencies](#)

About Virtual Business Services

The Virtual Business Services feature provides visualization, orchestration, and reduced frequency and duration of service disruptions for multi-tier business applications running on heterogeneous operating systems and virtualization technologies. A virtual business service represents the multi-tier application as a consolidated entity that helps you manage operations for a business service. It builds on the high availability and disaster recovery provided for the individual tiers by Veritas InfoScale products such as Cluster Server.

Application components that are managed by Cluster Server or Microsoft Failover Clustering can be actively managed through a virtual business service.

You can use the Veritas InfoScale Operations Manager Management Server console to create, configure, and manage virtual business services.

Features of Virtual Business Services

The following VBS operations are supported:

- Start Virtual Business Services from the Veritas InfoScale Operations Manager console: When a virtual business service starts, its associated service groups are brought online.

- Stop Virtual Business Services from the Veritas InfoScale Operations Manager console: When a virtual business service stops, its associated service groups are taken offline.
- Applications that are under the control of ApplicationHA can be part of a virtual business service. ApplicationHA enables starting, stopping, and monitoring of an application within a virtual machine. If applications are hosted on VMware virtual machines, you can configure the virtual machines to automatically start or stop when you start or stop the virtual business service, provided the vCenter for those virtual machines has been configured in Veritas InfoScale Operations Manager.
- Define dependencies between service groups within a virtual business service: The dependencies define the order in which service groups are brought online and taken offline. Setting the correct order of service group dependency is critical to achieve business continuity and high availability. You can define the dependency types to control how a tier reacts to high availability events in the underlying tier. The configured reaction could be execution of a predefined policy or a custom script.
- Manage the virtual business service from Veritas InfoScale Operations Manager or from the clusters participating in the virtual business service.
- Recover the entire virtual business service to a remote site when a disaster occurs.

Sample virtual business service configuration

This section provides a sample virtual business service configuration comprising a multi-tier application. [Figure 15-1](#) shows a Finance application that is dependent on components that run on three different operating systems and on three different clusters.

- Databases such as Oracle running on Solaris operating systems form the database tier.
- Middleware applications such as WebSphere running on AIX operating systems form the middle tier.
- Web applications such as Apache and IIS running on Windows and Linux virtual machines form the Web tier.

Each tier can have its own high availability mechanism. For example, you can use Cluster Server for the databases and middleware applications for the Web servers.

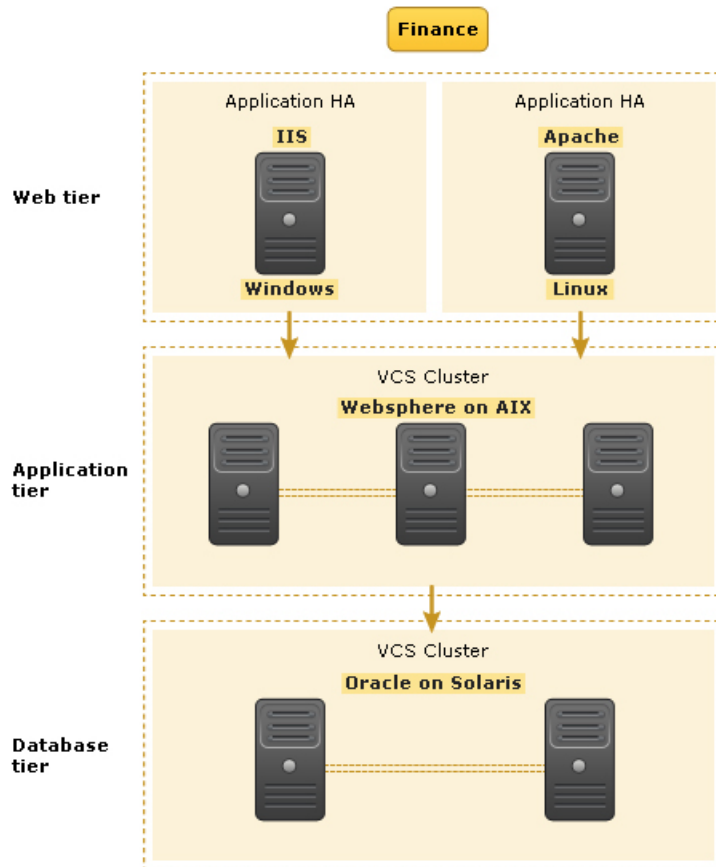
Figure 15-1 Sample virtual business service configuration

Each time you start the Finance business application, typically you need to bring the components online in the following order – Oracle database, WebSphere, Apache and IIS. In addition, you must bring the virtual machines online before you start the Web tier. To stop the Finance application, you must take the components offline in the reverse order. From the business perspective, the Finance service is unavailable if any of the tiers becomes unavailable.

When you configure the Finance application as a virtual business service, you can specify that the Oracle database must start first, followed by WebSphere and the Web servers. The reverse order automatically applies when you stop the virtual business service. When you start or stop the virtual business service, the components of the service are started or stopped in the defined order.

For more information about Virtual Business Services, refer to the *Virtual Business Service–Availability User's Guide*.

About choosing between VCS and VBS level dependencies

While a VBS typically has service groups across clusters, you can also have two or more service groups from a single cluster participate in a given VBS. In this case, you can choose to configure either VCS dependency or VBS dependency between these intra-cluster service groups. Veritas recommends use of VCS dependency in this case. However, based on your requirement about the type of fault policy desired, you can choose appropriately. For information about VBS fault policies, refer to the *Virtual Business Service–Availability User's Guide*.

See [“Service group dependency configurations”](#) on page 479.

Veritas High Availability Configuration wizard

- [Chapter 16. Introducing the Veritas High Availability Configuration wizard](#)
- [Chapter 17. Administering application monitoring from the Veritas High Availability view](#)

Introducing the Veritas High Availability Configuration wizard

This chapter includes the following topics:

- [About the Veritas High Availability Configuration wizard](#)
- [Launching the Veritas High Availability Configuration wizard](#)
- [Typical VCS cluster configuration in a physical environment](#)

About the Veritas High Availability Configuration wizard

The Veritas High Availability Configuration wizard can be used to configure applications that use active-passive storage. Active-passive storage can access only one node at a time. Apart from configuring application availability, the wizard also sets up other components (for example: networking, storage) required for successful application monitoring.

Before you configure an application for monitoring, you must configure a cluster. You can use the VCS Cluster Configuration wizard to configure a cluster. Refer to the *VCS Installation Guide* for the steps to configure a cluster.

You can use the Veritas High Availability Configuration wizard to configure the applications listed in [Table 16-1](#).

Table 16-1 Supported applications

Application	Platform/Virtualization technology
Generic application	<ul style="list-style-type: none"> ■ AIX ■ Linux ■ Solaris
Oracle	VMware on Linux
SAP WebAS	VMware on Linux
WebSphere MQ	VMware on Linux

See “[Launching the Veritas High Availability Configuration wizard](#)” on page 535.

For information on the procedure to configure a particular application, refer to the application-specific agent guide.

Launching the Veritas High Availability Configuration wizard

In a physical Linux environment, VMware virtual environment, logical domain, or LPAR, you can launch the Veritas High Availability Configuration wizard using:

- Client: [To launch the wizard from the Client](#)
- A browser window: [To launch the wizard from a browser window](#)

In addition, in a Linux environment, you can also launch the wizard using:

- haappwizard utility: [To launch the wizard using the haappwizard utility](#)

In addition, in a VMware virtual environment, you can also launch the wizard using:

- VMware vSphere Client: [To launch the wizard from the VMware vSphere Client](#)

To launch the wizard from the Client

- 1 Log in to the Management Server console.
- 2 In the home page, click the **Availability** icon from the list of perspectives.
- 3 In the **Data Center** tree under the **Manage** pane, locate the cluster.
- 4 Navigate to the **Systems** object under the cluster.
- 5 Locate the system on which the application is running or application prerequisites are met.
- 6 Right-click on the system, and then click **Configure Application**.

To launch the wizard from a browser window

- 1 Open a browser window and enter the following URL:

`https://system_name_or_IP:5634/vcs/admin/application_health.html`

system_name_or_IP is the system name or IP address of the system on which you want to configure application monitoring.

- 2 In the Authentication dialog box, enter the username and password of the user who has administrative privileges.
- 3 Depending on your setup, use one of the following options to launch the wizard:
 - If you have not configured a cluster, click the **Configure a VCS Cluster** link.
 - If you have already configured a cluster, click **Actions > Configure Application for High Availability** or the **Configure Application for High Availability** link.
 - If you have already configured a cluster and configured an application for monitoring, click **Actions > Configure Application for High Availability**.

Note: In the Storage Foundation and High Availability (SFHA) 6.2 release and later, the `haappwizard` utility has been deprecated.

To launch the wizard using the `haappwizard` utility

The `haappwizard` utility allows you to launch the Veritas High Availability Configuration wizard. The utility is part of the product package and is installed in the `/opt/VRTSvcs/bin` directory.

- ◆ Enter the following command to launch the Veritas High Availability Configuration wizard:

```
happwizard [-hostname host_name] [-browser browser_name] [-help]
```

The following table describes the options of the `happwizard` utility:

Table 16-2 Options of the `happwizard` utility

<code>-hostname</code>	Allows you to specify the host name or IP address of the system from which you want to launch the Veritas High Availability Configuration wizard. If you do not specify a host name or IP address, the Veritas High Availability Configuration wizard is launched on the local host.
------------------------	--

Table 16-2 Options of the happwizard utility (*continued*)

-browser	Allows you to specify the browser name. The supported browsers are Internet Explorer and Firefox. For example, enter <code>iexplore</code> for Internet Explorer and <code>firefox</code> for Firefox. Note: The value is case-insensitive.
-help	Displays the command usage.

To launch the wizard from the VMware vSphere Client

- 1 Launch the VMware vSphere Client and connect to the VMware vCenter Server that hosts the virtual machine.
- 2 From the vSphere Client's Inventory view in the left pane, select the virtual machine where you want to configure application monitoring.
- 3 Skip this step if you have already configured single sign-on during guest installation.

Select the Veritas High Availability tab and in the Veritas High Availability View page, specify the credentials of a user account that has administrative privileges on the virtual machine and click **Configure**.

The Veritas High Availability console sets up a permanent authentication for the user account on that virtual machine.

- 4 Depending on your setup, use one of the following options to launch the wizard:
 - If you have not configured a cluster, click the **Configure a VCS Cluster** link.
 - If you have already configured a cluster, click **Actions > Configure Application for High Availability** or the **Configure Application for High Availability** link.
 - If you have already configured a cluster and configured an application for monitoring and to configure another application for monitoring, click **Actions > Configure Application for High Availability**.

Typical VCS cluster configuration in a physical environment

A typical VCS cluster configuration in a physical environment involves two or more physical machines.

The application binaries are installed on a local or shared storage and the data files should be installed on a shared storage. The VCS agents monitor the application

components and services, and the storage and network components that the application uses.

Figure 16-1 Typical generic applications cluster configuration in a physical environment

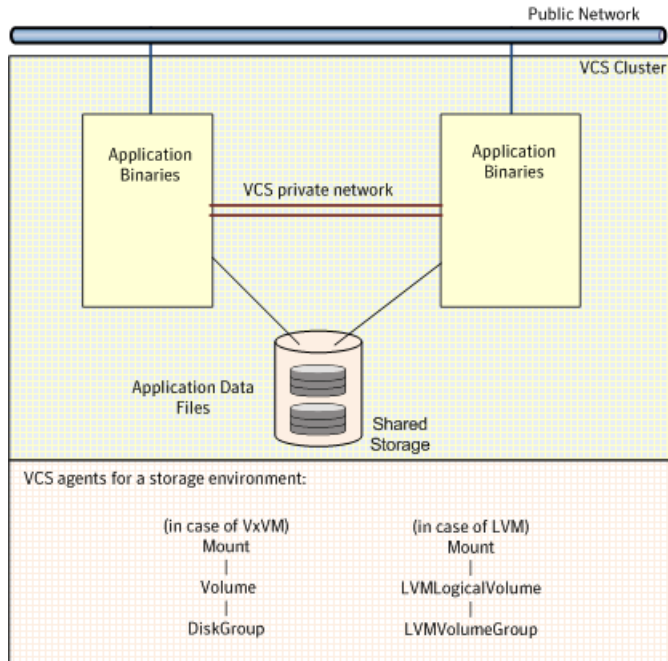

During a fault, the VCS storage agents fail over the storage to a new system. The VCS network agents bring the network components online and the application-specific agents then start application services on the new system.

Administering application monitoring from the Veritas High Availability view

This chapter includes the following topics:

- [Administering application monitoring from the Veritas High Availability view](#)
- [Administering application monitoring settings](#)

Administering application monitoring from the Veritas High Availability view

The Veritas High Availability view is a Web-based graphic user interface that you can use to administer application availability with Cluster Server (VCS).

This interface supports physical and virtual systems running Linux, Solaris, and AIX operating systems. The interface supports virtual environments such as IBM PowerVM, Oracle VM Server for SPARC, Red Hat Enterprise Virtualization (RHEV), Kernel-based Virtual Machine (KVM), and VMware.

You can launch the Veritas High Availability view from an Internet browser, by using the following URL:

`https://SystemNameorIP:5634/vcs/admin/application_health.html?priv=ADMIN`
where *SystemNameorIP* is the system name or the IP address of the physical or virtual system from where you want to access the tab.

In a VMware virtual environment, you can embed the Veritas High Availability view as a tab in the vSphere Client menu (both the desktop and Web versions).

You can perform tasks such as start, stop, or fail over an application, without the need for specialized training in VCS commands, operating systems, or virtualization technologies. You can also perform advanced tasks such as VCS cluster configuration and application (high availability) configuration from this view, by using simple wizard-based steps.

Use the Veritas High Availability view to perform the following tasks:

- To configure a VCS cluster
- To add a system to a VCS cluster
- To configure and unconfigure application monitoring
- To unconfigure the VCS cluster
- To start and stop configured applications
- To add and remove failover systems
- To enter and exit maintenance mode
- To switch an application
- To determine the state of an application (components)
- To clear Fault state
- To resolve a held-up operation
- To modify application monitoring settings
- To view application dependency
- To view component dependency

Understanding the Veritas High Availability view

The Veritas High Availability view displays the consolidated health information for applications running in a Cluster Server (VCS) cluster. The cluster may include one or more systems.

The Veritas High Availability tab displays application information for the entire VCS cluster, not just the local system.

Note: If the local system is not part of any VCS cluster, then the Veritas Application High Availability view displays only the following link: **Configure a VCS cluster**.

If you are yet to configure an application for monitoring in a cluster of which the local system is a member, then the Veritas Application High Availability view displays only the following link: **Configure an application for high availability**.

The Veritas High Availability view uses icons, color coding, dependency graphs, and tool tips to report the detailed status of an application.

The Veritas High Availability view displays complex applications, in terms of multiple interdependent instances of that application. Such instances represent component groups (also known as service groups) of that application. Each service group in turn includes several critical components (resources) of the application.

The following figure shows the Veritas High Availability view, with one instance of Oracle Database and one instance of a generic application configured for high availability in a two-node VCS cluster:



1. Title bar
2. Actions menu
3. Aggregate Status Bar
4. Application dependency graph
5. Application table
6. Application-specific task menu
7. Component dependency graph

The Veritas High Availability view includes the following parts:

- Title bar: Displays the name of the VCS cluster, the Actions menu, the Refresh icon, the Alert icon. Note that the Alert icon appears only if the Veritas High Availability view fails to display a system, or displays stale data.
- Actions menu: Includes a drop-down list of operations that you can perform with effect across the cluster. These include: Configuring a cluster, Configuring an application for high availability; Unconfigure all applications; and Unconfigure VCS cluster.
- Aggregate status bar: Displays a summary of applications running in the cluster. This includes the total number of applications, and a breakdown of the number of applications in Online, Offline, Partial, and Faulted states.
- Application dependency graph: Illustrates the order in which the applications or application instances, must start or stop.
 If an application must start first for another application to successfully start, the earlier application appears at a lower level in the graph. A line connects the two applications to indicate the dependency. If no such dependency exists, all applications appear in a single horizontal line.
- Application table: Displays a list of all applications configured in the VCS cluster that is associated with the local system.
 Each application is listed in a separate row. Each row displays the systems where the application is configured for monitoring.
 The title bar of each row displays the following entities to identify the application or application instance (service group):
 - Display name of the application (for example, Payroll application)
 - Type of application (for example, Custom)
 - Service group name
- Application-specific task menu: Appears in each application-specific row of the application table. The menu includes application-specific tasks such as Start, Stop, Switch, and a dropdown list of more tasks. The More dropdown list includes tasks such as Add a failover system, and Remove a failover system.
- Component dependency graph: Illustrates the order in which application components (resources) must start or stop for the related application or application instance to respectively start or stop. The component dependency graph by default does not appear in the application table. To view the component dependency graph for an application, you must click a system on which the application is running.
 The track pad, at the right-bottom corner helps you navigate through component dependency graphs.
 If you do not want to view the component dependency graph, in the top left corner of the application row, click **Close**.

To view the status of configured applications

In the application dependency graph, click the application for which you want to view the status. If the appropriate row is not already visible, the application table automatically scrolls to the appropriate row. The row displays the state of the application for each configured failover system in the cluster for that application.

If you click any system in the row, a component dependency graph appears. The graph uses symbols, color code, and tool tips to display the health of each application component. Roll the mouse over a system or component to see its health details.

The health of each application/application component on the selected system is displayed in terms of the following states:

Table 17-1 Application states

State	Description
Online	Indicates that the configured application or application components are running on the system. If the application is offline on at least one other failover system, an alert appears next to the application name.
Offline	Indicates that the configured application or its components are not running on the system.
Partial	Indicates that either the application or its components are being started on the system or VCS was unable to start one or more of the configured components If the application is offline on at least one other failover system, an alert appears next to the application name.
Faulted	Indicates that the configured application or its components have unexpectedly stopped running.

To configure or unconfigure application monitoring

Use the Veritas High Availability view to configure or un-configure an application for monitoring in a cluster under Cluster Server (VCS) control.

The view provides you with specific links to perform the following configuration tasks:

- **Configure a VCS cluster:**
 If the local system is not part of a VCS cluster, the Veritas High Availability view appears blank, except for the link **Configure a VCS cluster**.

Before you can configure application monitoring, you must click the **Configure a VCS cluster** link to launch the VCS Cluster Configuration wizard. The wizard helps you configure a VCS cluster, where the local system is by default a cluster system.

- Configure the first application for monitoring in a VCS cluster:
If you have not configured any application for monitoring in the cluster, the Veritas High Availability view appears blank except for the link **Configure an application for high availability**.
Click the link to launch the Veritas High Availability Configuration Wizard. Use the wizard to configure application monitoring.
Also, in applications where the Veritas High Availability Configuration Wizard is supported, for detailed wizard-based steps, see the application-specific VCS agent configuration guide. For custom applications, see the *Cluster Server Generic Application Agent Configuration Guide*.
- Add a system to the VCS cluster:
Click **Actions > Add a System to VCS Cluster** to add a system to a VCS cluster where the local system is a cluster member. Adding a system to the cluster does not automatically add the system as a failover system for any configured application. To add a system as a failover system, see (add a cross-reference to 'To add or remove a failover system').
- Configure an application or add an application to the existing application monitoring configuration:
Click **Actions > Configure an application for high availability** to launch the Veritas High Availability Application Monitoring Configuration Wizard. Use the wizard to configure application monitoring.
- Unconfigure monitoring of an application:
In the appropriate row of the application table, click **More > Unconfigure Application Monitoring** to delete the application monitoring configuration from the VCS.
Note that this step does not remove VCS from the system or the cluster, this step only removes the monitoring configuration for that application.
Also, to unconfigure monitoring for an application, you can perform one of the following procedures: unconfigure monitoring of all applications, or unconfigure VCS cluster.
- Unconfigure monitoring of all applications:
Click **Actions > Unconfigure all applications**. This step deletes the monitoring configuration for all applications configured in the cluster.
- Unconfigure VCS cluster:
Click **Actions > Unconfigure VCS cluster**. This step stops the VCS cluster, removes VCS cluster configuration, and unconfigures application monitoring.

To start or stop applications

Use the following options on the Veritas High Availability view to control the status of the configured application and the associated components or component groups (application instances).

Note that the **Start** and **Stop** links are dimmed in the following cases:

- If you have not configured any associated components or component groups (resources or service groups) for monitoring
- If the application is in maintenance mode
- If no system exists in the cluster, where the application is not already started or stopped as required.

To start an application

- 1 In the appropriate row of the application table, click **Start**.
- 2 If the application (service group) is of the failover type, on the Start Application panel, click **Any system**. VCS uses pre-defined policies to decide the system where to start the application.

If the application (service group) is of the parallel type, on the Start Application panel, click **All systems**. VCS starts the application on all required systems, where the service group is configured.

Note: Based on service group type, either the Any system or the All Systems link automatically appears.

To learn more about policies, and parallel and failover service groups, see the *Cluster Server Administrator's Guide*.

If you want to specify the system where you want to start the application, click **User selected system**, and then click the appropriate system.

- 3 If the application that you want to start requires other applications or component groups (service groups) to start in a specific order, then check the **Start the dependent components in order** check box, and then click **OK**.

To stop an application

- 1 In the appropriate row of the application table, click **Stop**.
- 2 If the application (service group) is of the failover type, in the Stop Application Panel, click **Any system**. VCS selects the appropriate system to stop the application.

If the application (service group) is of the parallel type, in the Stop Application Panel click **All systems**. VCS stops the application on all configured systems.

Note: Based on service group type, either the Any system or the All Systems link automatically appears.

To learn more about parallel and failover service groups, see the *Cluster Server Administrator's Guide*.

If you want to specify the system where you want to stop the application, click **User selected system**, and then click the appropriate system.

- 3 If the application that you want to stop requires other applications or component groups (service groups) to stop in a specific order, then check the **Stop the dependent components in order** check box, and then click **OK**.

To suspend or resume application monitoring

After configuring application monitoring you may want to perform routine maintenance tasks on those applications. These tasks may or may not involve stopping the application but may temporarily affect the state of the applications and its dependent components. If there is any change to the application status, Cluster Server (VCS) may try to restore the application state. This may potentially affect the maintenance tasks that you intend to perform on those applications.

The **Enter Maintenance Mode** link is automatically dimmed if the application is already in maintenance mode. Conversely, if the application is not in maintenance mode, the **Exit Maintenance Mode** link is dimmed.

The Veritas High Availability tab provides the following options:

To enter maintenance mode

- 1 In the appropriate row, click **More> Enter Maintenance Mode**.

During the time the monitoring is suspended, Veritas high availability solutions do not monitor the state of the application and its dependent components. The Veritas High Availability view does not display the current status of the application. If there is any failure in the application or its components, VCS takes no action.
- 2 While in maintenance mode, if a virtual machine restarts, if you want application monitoring to remain in maintenance mode, then in the Enter Maintenance Mode panel, check the **Suspend the application availability even after reboot** check box, and then click **OK** to enter maintenance mode.

To exit the maintenance mode

- 1 In the appropriate row, click **More> Exit Maintenance Mode**, and then click **OK** to exit maintenance mode.
- 2 Click the Refresh icon in the top right corner of the Veritas High Availability view, to confirm that the application is no longer in maintenance mode.

To switch an application to another system

If you want to gracefully stop an application on one system and start it on another system in the same cluster, you must use the Switch link. You can switch the application only to a system where it is not running.

Note that the Switch link is dimmed in the following cases:

- If you have not configured any application components for monitoring
- If you have not specified any failover system for the selected application
- If the application is in maintenance mode
- If no system exists in the cluster, where the application can be switched
- If the application is not in online/partial state on even a single system in the cluster

To switch an application

- 1 In the appropriate row of the application table, click **Switch**.
- 2 If you want VCS to decide to which system the application must switch, based on policies, then in the Switch Application panel, click **Any system**, and then click **OK**.

To learn more about policies, see the *Cluster Server Administrator's Guide*.

If you want to specify the system where you want to switch the application, click **User selected system**, and then click the appropriate system, and then click **OK**.

VCS stops the application on the system where the application is running, and starts it on the system you specified.

To add or remove a failover system

Each row in the application table displays the status of an application on systems that are part of a VCS cluster. The displayed system/s either form a single-system Cluster Server (VCS) cluster with application restart configured as a high-availability measure, or a multi-system VCS cluster with application failover configured. In the displayed cluster, you can add a new system as a failover system for the configured application.

The system must fulfill the following conditions:

- The system is not part of any other VCS cluster.
- The system has at least two network adapters.
- The required ports are not blocked by a firewall.
- The application is installed identically on all the systems, including the proposed new system.

To add a failover system, perform the following steps:

Note: The following procedure describes generic steps to add a failover system. The wizard automatically populates values for initially configured systems in some fields. These values are not editable.

To add a failover system

- 1 In the appropriate row of the application table, click **More > Add Failover System**.
- 2 Review the instructions on the welcome page of the Veritas High Availability Configuration Wizard, and click **Next**.

- 3** If you want to add a system from the Cluster systems list to the Application failover targets list, on the Configuration Inputs panel, select the system in the Cluster systems list. Use the Edit icon to specify an administrative user account on the system. You can then move the required system from the Cluster system list to the Application failover targets list. Use the up and down arrow keys to set the order of systems in which VCS agent must failover applications.

If you want to specify a failover system that is not an existing cluster node, on the Configuration Inputs panel, click **Add System**, and in the Add System dialog box, specify the following details:

System Name or IP address	Specify the name or IP address of the system that you want to add to the VCS cluster.
User name	Specify the user name with administrative privileges on the system. If you want to specify the same user account on all systems that you want to add, check the Use the specified user account on all systems box.
Password	Specify the password for the account you specified.
Use the specified user account on all systems	Click this check box to use the specified user credentials on all the cluster systems.

The wizard validates the details, and the system then appears in the Application failover target list.

- 4** If you are adding a failover system from the existing VCS cluster, the Network Details panel does not appear.

If you are adding a new failover system to the existing cluster, on the Network Details panel, review the networking parameters used by existing failover systems. Appropriately modify the following parameters for the new failover system.

Note: The wizard automatically populates the networking protocol (UDP or Ethernet) used by the existing failover systems for Low Latency Transport communication. You cannot modify these settings.

- To configure links over ethernet, select the adapter for each network communication link. You must select a different network adapter for each communication link.
- To configure links over UDP, specify the required details for each communication link.

Network Adapter	<p>Select a network adapter for the communication links.</p> <p>You must select a different network adapter for each communication link.</p> <p>Veritas recommends that one of the network adapters must be a public adapter and the VCS cluster communication link using this adapter is assigned a low priority.</p> <p>Note: Do not select the teamed network adapter or the independently listed adapters that are a part of teamed NIC.</p>
IP Address	Select the IP address to be used for cluster communication over the specified UDP port.
Port	<p>Specify a unique port number for each link. You can use ports in the range 49152 to 65535.</p> <p>The specified port for a link is used for all the cluster systems on that link.</p>
Subnet mask	Displays the subnet mask to which the specified IP belongs.

- 5 If a virtual IP is not configured as part of your application monitoring configuration, the Virtual Network Details page is not displayed. Else, on the Virtual Network Details panel, review the following networking parameters that the failover system must use, and specify the NIC:

Virtual IP address	Specifies a unique virtual IP address.
Subnet mask	Specifies the subnet mask to which the IP address belongs.
NIC	For each newly added system, specify the network adaptor that must host the specified virtual IP.

- 6 On the Configuration Summary panel, review the VCS cluster configuration summary, and then click **Next** to proceed with the configuration.
- 7 On the Implementation panel, the wizard adds the specified system to the VCS cluster, if it is not already a part. It then adds the system to the list of failover targets. The wizard displays a progress report of each task.
 - If the wizard displays an error, click **View Logs** to review the error description, troubleshoot the error, and re-run the wizard from the Veritas High Availability view.

- Click **Next**.
- 8** On the Finish panel, click **Finish**. This completes the procedure for adding a failover system. You can view the system in the appropriate row of the application table.

Similarly you can also remove a system from the list of application failover targets.

Note: You cannot remove a failover system if an application is online or partially online on the system.

To remove a failover system

- 1** In the appropriate row of the application table, click **More > Remove Failover System**.
- 2** On the Remove Failover System panel, click the system that you want to remove from the monitoring configuration, and then click **OK**.

Note: This procedure only removes the system from the list of failover target systems, not from the VCS cluster. To remove a system from the cluster, use VCS commands. For details, see the *VCS Administrator's Guide*.

To clear Fault state

When you fix an application fault on a system, you must further clear the application Faulted state on that system. Unless you clear the Faulted state, VCS cannot failover the application on that system.

You can use the Veritas High Availability view to clear this faulted state at the level of a configured application component (resource).

The Clear Fault link is automatically dimmed if there is no faulted system in the cluster.

To clear Fault state

- 1** In the appropriate row of the application table, click **More > Clear Fault state**.
- 2** In the Clear Fault State panel, click the system where you want to clear the Faulted status of a component, and then click **OK**.

To resolve a held-up operation

When you try to start or stop an application, in some cases, the start or stop operation may get held-up mid course. This may be due to VCS detecting an incorrect internal state of an application component. You can resolve this issue by

using the resolve a held-up operation link. When you click the link, VCS appropriately resets the internal state of any held-up application component. This process prepares the ground for you to retry the original start or stop operation, or initiate another operation.

To resolve a held-up operation

- 1 In the appropriate row of the application table, click **More > Resolve a held-up operation**.
- 2 In the Resolve a held-up operation panel, click the system where you want to resolve the held-up operation, and then click **OK**.

To determine application state

The Veritas High Availability view displays the consolidated health information of all applications configured for monitoring in a VCS cluster. The application health information is automatically refreshed every 60 seconds.

If you do not want to wait for the automatic refresh, you can instantaneously determine the state of an application by performing the following steps:

To determine application state

- 1 In the appropriate row of the Application table, click **More > Determine Application State**.
- 2 In the Determine Application State panel, select a system and then click **OK**.

Note: You can also select multiple systems, and then click **OK**.

To remove all monitoring configurations

To discontinue all existing application monitoring in a VCS cluster, perform the following step:

- On the Veritas High Availability view, in the Title bar, click **Actions > Unconfigure all applications**. When a confirmation message appears, click **OK**.

To remove VCS cluster configurations

If you want to create a different VCS cluster, say with new systems, a different LLT protocol, or secure communication mode, you may want to remove existing VCS cluster configurations. To remove VCS cluster configurations, perform the following steps:

Note: The following steps deletes all cluster configurations, (including networking and storage configurations), as well as application-monitoring configurations.

- On the Title bar of the Veritas High Availability view, click **Actions >Unconfigure VCS cluster**.
- In the Unconfigure VCS Cluster panel, review the Cluster Name and Cluster ID, and specify the User name and Password of the Cluster administrator, and then click **OK**.

Administering application monitoring settings

The Veritas High Availability tab lets you define and modify settings that control application monitoring with Cluster Server(VCS). You can define the settings on a per application basis. The settings apply to all systems in a VCS cluster where the application is configured for monitoring.

The following settings are available:

- **App.StartStopTimeout:**
This setting defines the number of seconds that VCS must wait for the application to start or stop, after initiating the operation.
When you click the Start Application or Stop Application links in the Veritas High Availability tab, VCS initiates an application start or stop, respectively. If the application does not respond within the stipulated time, the tab displays an error. A delay in the application response does not indicate that the application or its dependent component has faulted. Parameters such as workload, system performance, and network bandwidth may affect the application response. VCS continues to wait for the application response even after the timeout interval elapses.
If the application fails to start or stop, VCS takes the necessary action depending on the other configured remedial actions.
You can set a AppStartStopTimeout value between 0 and 600 seconds. The default value is 30 seconds.
- **App.RestartAttempts:**
This setting defines the number of times that VCS must try to restart a failed application. If an application fails to start within the specified number of attempts, VCS fails over the application to a configured failover system. You can set a AppRestartAttempts value between 1 and 6. The default value is 1.
- **App.DisplayName:**
This setting lets you specify an easy-to-use display name for a configured application. For example, Payroll application. VCS may internally use a different

service group name to uniquely identify the same application. However, the service group name, for example OraSG2, may not be intuitive to understand, or easy to parse while navigating the application table. Moreover, once configured, you cannot edit the service group name. In contrast, VCS allows you to modify the display name as required. Note that the Veritas High Availability tab displays both the display name and the service group name associated with the configured application.

To modify the application monitoring configuration settings

- 1** Launch the vSphere Client and from the inventory pane on the left, select the virtual machine that is a part of the VCS cluster where you have configured application monitoring.
- 2** Click **Veritas High Availability**, to view the Veritas High Availability tab.
- 3** In the appropriate row of the application table, click **More > Modify Settings**.
- 4** In the Modify Settings panel, click to highlight the setting that you want to modify.
- 5** In the Value column, enter the appropriate value, and then click **OK**.

Cluster configurations for disaster recovery

- [Chapter 18. Connecting clusters—Creating global clusters](#)
- [Chapter 19. Administering global clusters from Cluster Manager \(Java console\)](#)
- [Chapter 20. Administering global clusters from the command line](#)
- [Chapter 21. Setting up replicated data clusters](#)
- [Chapter 22. Setting up campus clusters](#)

Connecting clusters—Creating global clusters

This chapter includes the following topics:

- [How VCS global clusters work](#)
- [VCS global clusters: The building blocks](#)
- [Prerequisites for global clusters](#)
- [About planning to set up global clusters](#)
- [Setting up a global cluster](#)
- [About cluster faults](#)
- [About setting up a disaster recovery fire drill](#)
- [Multi-tiered application support using the RemoteGroup agent in a global environment](#)
- [Test scenario for a multi-tiered environment](#)

How VCS global clusters work

Local clustering provides local failover for each site or building. But, these configurations do not provide protection against large-scale disasters such as major floods, hurricanes, and earthquakes that cause outages for an entire city or region. The entire cluster could be affected by an outage.

In such situations, VCS global clusters ensure data availability by migrating applications to remote clusters located considerable distances apart.

Let us take the example of an Oracle database configured in a VCS global cluster. Oracle is installed and configured in both clusters. Oracle data is located on shared disks within each cluster and is replicated across clusters to ensure data concurrency. The Oracle service group is online on a system in cluster A and is configured to fail over globally, on clusters A and B.

Figure 18-1 shows a sample global cluster setup.

Figure 18-1 Sample global cluster setup

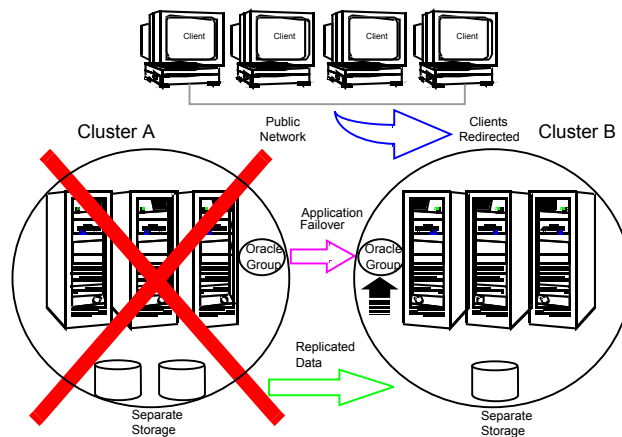

VCS continuously monitors and communicates events between clusters. Inter-cluster communication ensures that the global cluster is aware of the state of the service groups that are configured in the global cluster at all times.

In the event of a system or application failure, VCS fails over the Oracle service group to another system in the same cluster. If the entire cluster fails, VCS fails over the service group to the remote cluster, which is part of the global cluster. VCS also redirects clients once the application is online on the new location.

VCS global clusters: The building blocks

VCS extends clustering concepts to wide-area high availability and disaster recovery with the following:

- Remote cluster objects
 See “[Visualization of remote cluster objects](#)” on page 558.
- Global service groups

- See [“About global service groups”](#) on page 558.
- Global cluster management
 - See [“About global cluster management”](#) on page 559.
- Serialization
 - See [“About serialization—The Authority attribute”](#) on page 560.
- Resiliency and right of way
 - See [“About resiliency and “Right of way””](#) on page 561.
- VCS agents to manage wide-area failover
 - See [“VCS agents to manage wide-area failover”](#) on page 561.
- Split-brain in two-cluster global clusters
 - See [“About the Steward process: Split-brain in two-cluster global clusters”](#) on page 564.
- Secure communication
 - See [“Secure communication in global clusters”](#) on page 565.

Visualization of remote cluster objects

VCS enables you to visualize remote cluster objects using any of the supported components that are used to administer VCS such as VCS CLI and Veritas InfoScale Operations Manager

See [“Components for administering VCS”](#) on page 48.

You can define remote clusters in your configuration file, `main.cf`. The Remote Cluster Configuration wizard provides an easy interface to do so. The wizard updates the `main.cf` files of all connected clusters with the required configuration changes.

See [“Adding a remote cluster”](#) on page 600.

About global service groups

A global service group is a regular VCS group with additional properties to enable wide-area failover. The global service group attribute `ClusterList` defines the list of clusters to which the group can fail over. The service group must be configured on all participating clusters and must have the same name on each cluster. The Global Group Configuration Wizard provides an easy interface to configure global groups.

See [“Administering global service groups”](#) on page 607.

VCS agents manage the replication during cross-cluster failover.

See [“VCS agents to manage wide-area failover”](#) on page 561.

About global cluster management

VCS enables you to perform operations (online, offline, switch) on global service groups from any system in any cluster. You must log on with adequate privileges for cluster operations.

See [“User privileges for cross-cluster operations”](#) on page 85.

You can bring service groups online or switch them to any system in any cluster. If you do not specify a target system, VCS uses the FailOverPolicy to determine the system.

See [“About defining failover policies”](#) on page 423.

Management of remote cluster objects is aided by inter-cluster communication enabled by the wide-area connector (wac) process.

About the wide-area connector process

The wide-area connector (wac) is a failover Application resource that ensures communication between clusters.

[Figure 18-2](#) is an illustration of the wide-area connector process.

Figure 18-2 Wide-area connector (wac) process

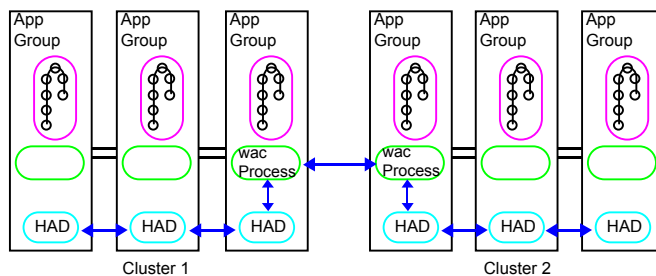

The wac process runs on one system in each cluster and connects with peers in remote clusters. It receives and transmits information about the status of the cluster, service groups, and systems. This communication enables VCS to create a consolidated view of the status of all the clusters configured as part of the global cluster. The process also manages wide-area heartbeating to determine the health of remote clusters. The process also transmits commands between clusters and returns the result to the originating cluster.

VCS provides the option of securing the communication between the wide-area connectors.

See [“Secure communication in global clusters”](#) on page 565.

About the wide-area heartbeat agent

The wide-area heartbeat agent manages the inter-cluster heartbeat. Heartbeats are used to monitor the health of remote clusters. VCS wide-area heartbeat agents include `lcmp` and `lcmpS`. While other VCS resource agents report their status to VCS engine, heartbeat agents report their status directly to the WAC process. The heartbeat name must be the same as the heartbeat type name. You can add only one heartbeat of a specific heartbeat type.

See [“Sample configuration for the wide-area heartbeat agent”](#) on page 560.

You can create custom wide-area heartbeat agents. For example, the VCS replication agent for SRDF includes a custom heartbeat agent for Symmetrix arrays.

You can add heartbeats using the `hahb -add heartbeatname` command and change the default values of the heartbeat agents using the `hahb -modify` command.

See [“Administering heartbeats in a global cluster setup”](#) on page 627.

See [“Heartbeat attributes \(for global clusters\)”](#) on page 846.

Sample configuration for the wide-area heartbeat agent

Following is a sample configuration for the wide-area heartbeat agent:

```
Heartbeat lcmp (
    ClusterList = {priclus
    Arguments @Cpriclus =
    {"10.209.134.1"
    )
```

About serialization—The Authority attribute

VCS ensures that global service group operations are conducted serially to avoid timing problems and to ensure smooth performance. The Authority attribute prevents a service group from coming online in multiple clusters at the same time. Authority is a persistent service group attribute and it designates which cluster has the right to bring a global service group online. The attribute cannot be modified at runtime.

If two administrators simultaneously try to bring a service group online in a two-cluster global group, one command is honored, and the other is rejected based on the value of the Authority attribute.

The attribute prevents bringing a service group online in a cluster that does not have the authority to do so. If the cluster holding authority is down, you can enforce a takeover by using the command `hagrp -online -force service_group`. This

command enables you to fail over an application to another cluster when a disaster occurs.

Note: A cluster assuming authority for a group does not guarantee the group will be brought online on the cluster. The attribute merely specifies the right to attempt bringing the service group online in the cluster. The presence of Authority does not override group settings like frozen, autodisabled, non-probed, and so on, that prevent service groups from going online.

You must seed authority if it is not held on any cluster.

Offline operations on global groups can originate from any cluster and do not require a change of authority to do so, because taking a group offline does not necessarily indicate an intention to perform a cross-cluster failover.

About the Authority and AutoStart attributes

The attributes Authority and AutoStart work together to avoid potential concurrency violations in multi-cluster configurations.

If the AutoStartList attribute is set, and if a group's Authority attribute is set to 1, the VCS engine waits for the wac process to connect to the peer. If the connection fails, it means the peer is down and the AutoStart process proceeds. If the connection succeeds, HAD waits for the remote snapshot. If the peer is holding the authority for the group and the remote group is online (because of takeover), the local cluster does not bring the group online and relinquishes authority.

If the Authority attribute is set to 0, AutoStart is not invoked.

About resiliency and "Right of way"

VCS global clusters maintain resiliency using the wide-area connector process and the ClusterService group. The wide-area connector process runs as long as there is at least one surviving node in a cluster.

The wide-area connector, its alias, and notifier are components of the ClusterService group.

VCS agents to manage wide-area failover

VCS agents now manage external objects that are part of wide-area failover. These objects include replication, DNS updates, and so on. These agents provide a robust framework for specifying attributes and restarts, and can be brought online upon fail over.

DNS agent

The DNS agent updates the canonical name-mapping in the domain name server after a wide-area failover.

See the *Cluster Server Bundled Agents Reference Guide* for more information.

VCS agents for Volume Replicator

You can use the following VCS agents for Volume Replicator in a VCS global cluster setup:

- **RVG agent**
The RVG agent manages the Replicated Volume Group (RVG). Specifically, it brings the RVG online, monitors read-write access to the RVG, and takes the RVG offline. Use this agent when using Volume Replicator for replication.
- **RVGPrimary agent**
The RVGPrimary agent attempts to migrate or take over a Secondary site to a Primary site following an application failover. The agent has no actions associated with the offline and monitor routines.
- **RVGShared agent**
The RVGShared agent monitors the RVG in a shared environment. This is a parallel resource. The RVGShared agent enables you to configure parallel applications to use an RVG in a cluster. The RVGShared agent monitors the RVG in a shared disk group environment.
- **RVGSharedPri agent**
The RVGSharedPri agent enables migration and takeover of a Volume Replicator replicated data set in parallel groups in a VCS environment. Bringing a resource of type RVGSharedPri online causes the RVG on the local host to become a primary if it is not already.
- **RVGLogowner agent**
The RVGLogowner agent assigns and unassigns a node as the logowner in the CVM cluster; this is a failover resource. The RVGLogowner agent assigns or unassigns a node as a logowner in the cluster. In a shared disk group environment, currently only the cvm master node should be assigned the logowner role.
- **RVGSnapshot agent**
The RVGSnapshot agent, used in fire drill service groups, takes space-optimized snapshots so that applications can be mounted at secondary sites during a fire drill operation. See the *Veritas InfoScale™ Replication Administrator's Guide* for more information.

In a CVM environment, the RVGShared agent, RVGSharedPri agent, RVGLogOwner agent, and RVGSnapshot agent are supported. For more information, see the *Cluster Server Bundled Agents Reference Guide*.

VCS agents for third-party replication technologies

VCS provides agents for other third-party array-based or application-based replication solutions. These agents are available in the High Availability Agent Pack software.

See the agent pack documentation for a list of replication technologies that VCS supports.

About the Steward process: Split-brain in two-cluster global clusters

Failure of all heartbeats between any two clusters in a global cluster indicates one of the following:

- The remote cluster is faulted.
- All communication links between the two clusters are broken.

In global clusters with three or more clusters, VCS queries the connected clusters to confirm that the remote cluster is truly down. This mechanism is called inquiry.

In a two-cluster setup, VCS uses the Steward process to minimize chances of a wide-area split-brain. The process runs as a standalone binary on a system outside of the global cluster configuration.

[Figure 18-3](#) depicts the Steward process to minimize chances of a split brain within a two-cluster setup.

Figure 18-3 Steward process: Split-brain in two-cluster global clusters

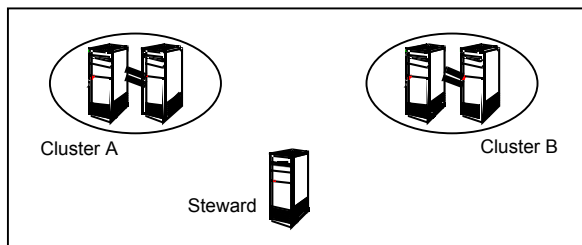

When all communication links between any two clusters are lost, each cluster contacts the Steward with an inquiry message. The Steward sends an ICMP ping to the cluster in question and responds with a negative inquiry if the cluster is running or with positive inquiry if the cluster is down. The Steward can also be used in configurations with more than two clusters. VCS provides the option of securing communication between the Steward process and the wide-area connectors.

See “[Secure communication in global clusters](#)” on page 565.

In non-secure configurations, you can configure the steward process on a platform that is different to that of the global cluster nodes. Secure configurations have not been tested for running the steward process on a different platform.

For example, you can run the steward process on a Windows system for a global cluster running on AIX systems. However, the VCS release for AIX contains the steward binary for AIX only. You must copy the steward binary for Windows from the VCS installation directory on a Windows cluster, typically `C:\Program Files\VERITAS\Cluster Server`.

A Steward is effective only if there are independent paths from each cluster to the host that runs the Steward. If there is only one path between the two clusters, you must prevent split-brain by confirming manually via telephone or some messaging system with administrators at the remote site if a failure has occurred. By default, VCS global clusters fail over an application across cluster boundaries with administrator confirmation. You can configure automatic failover by setting the `ClusterFailOverPolicy` attribute to `Auto`.

The default port for the steward is 14156.

Secure communication in global clusters

In global clusters, VCS provides the option of making the following types of communication secure:

- Communication between the wide-area connectors.
- Communication between the wide-area connectors and the Steward process.

For secure authentication, the wide-area connector process gets a security context as an account in the local authentication broker on each cluster node.

The WAC account belongs to the same domain as HAD and Command Server and is specified as:

```
name = WAC
domain = VCS_SERVICES@cluster_uid
```

See [“Cluster attributes”](#) on page 831.

You must configure the wide-area connector process in all clusters to run in secure mode. If the wide-area connector process runs in secure mode, you must run the Steward in secure mode.

See [“Prerequisites for clusters running in secure mode”](#) on page 568.

Prerequisites for global clusters

This topic describes the prerequisites for configuring global clusters.

Prerequisites for cluster setup

You must have at least two clusters to set up a global cluster. Every cluster must have the required licenses. A cluster can be part of only one global cluster. VCS supports a maximum of four clusters participating in a global cluster.

Clusters must be running on the same platform; the operating system versions can be different. Clusters must be using the same VCS version.

Cluster names must be unique within each global cluster; system and resource names need not be unique across clusters. Service group names need not be unique across clusters; however, global service groups must have identical names.

Every cluster must have a valid virtual IP address, which is tied to the cluster. Define this IP address in the cluster's ClusterAddress attribute. This address is normally configured as part of the initial VCS installation.

The global cluster operations require that the port for Wide-Area Connector (WAC) process (default is 14155) are open across firewalls.

All clusters in a global cluster must use either IPv4 or IPv6 addresses. VCS does not support configuring clusters that use different Internet Protocol versions in a global cluster.

For remote cluster operations, you must configure a VCS user with the same name and privileges in each cluster.

See [“User privileges for cross-cluster operations”](#) on page 85.

Prerequisites for application setup

Applications to be configured as global groups must be configured to represent each other in their respective clusters. All application groups in a global group must have the same name in each cluster. The individual resources of the groups can be different. For example, one group might have a MultiNIC resource or more Mount-type resources. Client systems redirected to the remote cluster in case of a wide-area failover must be presented with the same application they saw in the primary cluster.

However, the resources that make up a global group must represent the same application from the point of the client as its peer global group in the other cluster. Clients redirected to a remote cluster should not be aware that a cross-cluster failover occurred, except for some downtime while the administrator initiates or confirms the failover.

Prerequisites for wide-area heartbeats

There must be at least one wide-area heartbeat going from each cluster to every other cluster. VCS starts communicating with a cluster only after the heartbeat reports that the cluster is alive. VCS uses the ICMP ping by default, the infrastructure for which is bundled with the product. VCS configures the Icmp heartbeat if you use Cluster Manager (Java Console) to set up your global cluster. Other heartbeats must be configured manually.

Although multiple heartbeats can be configured but one heartbeat is sufficient to monitor the health of the remote site. Because Icmp & IcmpS heartbeats use IP network to check the health of the remote site. Even one heartbeat is not a single point of failure if the network is sufficiently redundant. Adding multiple heartbeats will not be useful if they have a single point of failure.

If you have a separate connection for the replication of data between the two sites, then that can be used to reduce single point of failure. Currently, Veritas only ships heartbeat agent for symmetric arrays.

Prerequisites for ClusterService group

The ClusterService group must be configured with the Application (for the wide-area connector), NIC, and IP resources. The service group may contain additional resources for Authentication Service or notification if these components are configured. The ClusterService group is configured automatically when VCS is installed or upgraded.

If you entered a license that includes VCS global cluster support during the VCS install or upgrade, the installer provides you an option to automatically configure a resource wac of type Application in the ClusterService group. The installer also configures the wide-area connector process.

You can run the Global Cluster Option (GCO) configuration wizard later to configure the WAC process and to update the ClusterService group with an Application resource for WAC.

Prerequisites for replication setup

VCS global clusters are used for disaster recovery, so you must set up real-time data replication between clusters. For supported replication technologies, you can use a VCS agent to manage the replication. These agents are available in the High Availability Agent Pack software.

See the High Availability agent pack documentation for a list of replication technologies that VCS supports.

Prerequisites for clusters running in secure mode

If you plan to configure secure communication among clusters in the global clusters, then you must meet the following prerequisites:

- You must configure the wide area connector processes in both clusters to run in secure mode.
When you configure security using the installer, the installer creates an AT account for the wide-area connector also.
- Both clusters must run in secure mode.
 - You can configure security by using the `installvcs -security` command.
For more information, see the *Cluster Server Installation Guide*.
- Both the clusters must share a trust relationship. You can set up a trust relationship by using the `installvcs -securitytrust` command.
For more information, see the *Cluster Server Installation Guide*.

About planning to set up global clusters

Before you set up the global cluster, make sure you completed the following:

- Review the concepts.
See “[VCS global clusters: The building blocks](#)” on page 557.
- Plan the configuration and verify that you have the required physical infrastructure.
See “[Prerequisites for global clusters](#)” on page 565.
- Verify that you have the required software to install VCS and a supported replication technology. If you use a third-party replication technology, then verify that you have the appropriate replication agent software.

[Figure 18-4](#) depicts the workflow to set up a global cluster where VCS cluster is already configured at site s1, and has application set up for high availability.

Figure 18-4 High-level workflow to set up VCS global clusters

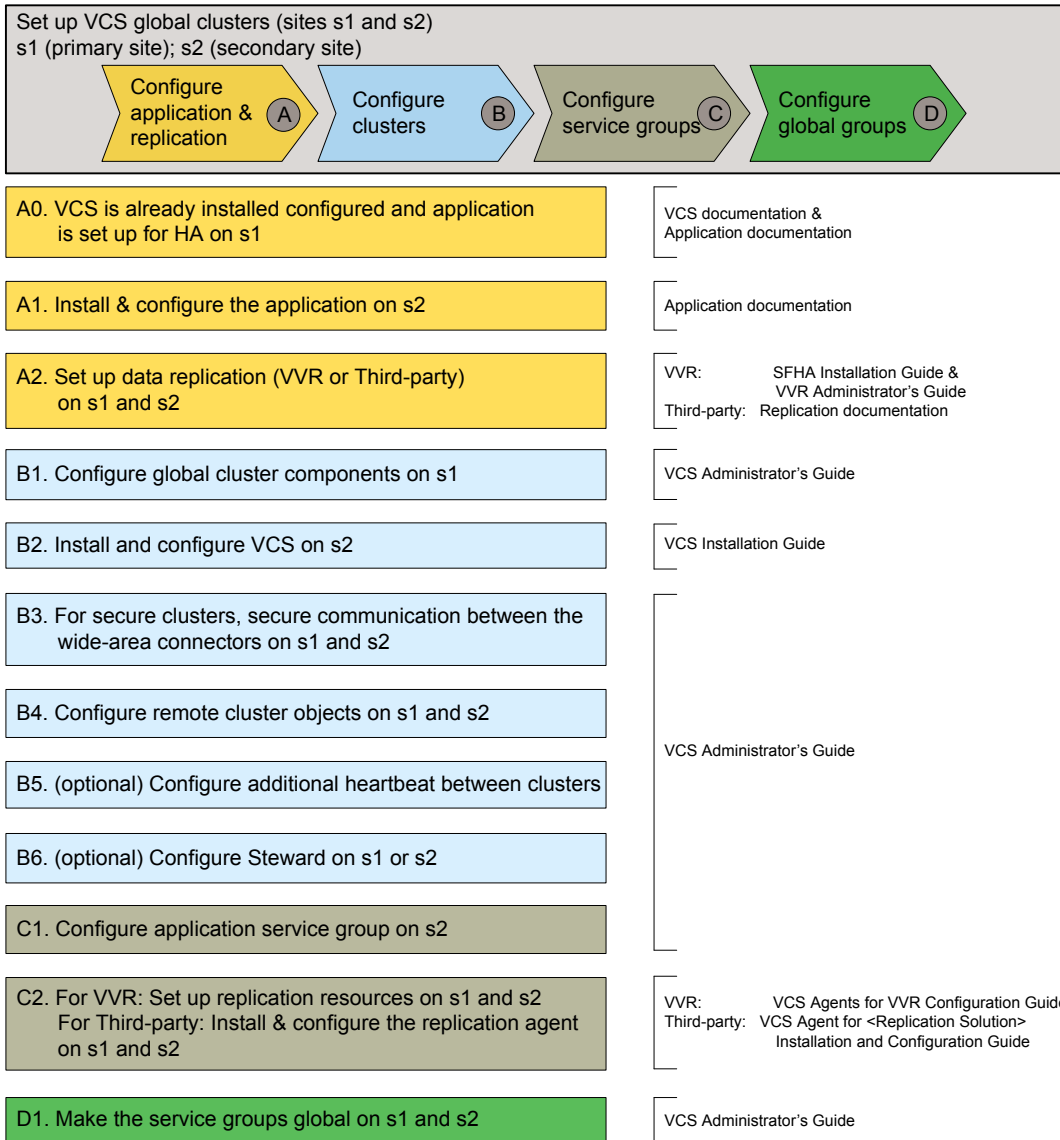

Setting up a global cluster

This procedure assumes that you have configured a VCS cluster at the primary site and have set up application for high availability.

In this example, a single-instance Oracle database is configured as a VCS service group (appgroup) on a two-node cluster.

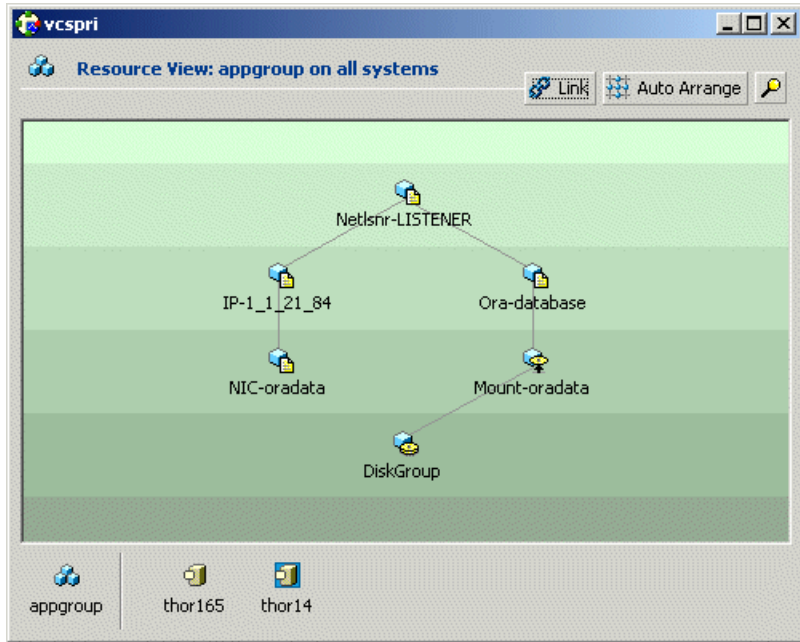

Table 18-1 lists the high-level tasks to set up VCS global clusters.

Table 18-1 Task map to set up VCS global clusters

Task	Reference
Task A	See “Configuring application and replication for global cluster setup” on page 570.
Task B	See “Configuring clusters for global cluster setup” on page 571.
Task C	See “Configuring service groups for global cluster setup” on page 578.
Task D	See “Configuring a service group as a global service group” on page 582.

Configuring application and replication for global cluster setup

Perform the following steps to configure application at the secondary site. This procedure assumes that you have already set up application for high availability at the primary site.

To configure application and replication

- 1 At the secondary site, install and configure the application that you want to make highly available.

See the corresponding application documentation for instructions.
- 2 At each site, set up data replication using a replication technology that VCS supports:
 - Volume Replicator
See the *Veritas InfoScale 7.1 Installation Guide* and the *Veritas InfoScale 7.1 Replication Administrator's Guide* for instructions.
 - A supported third-party replication technology
See the corresponding replication documentation for instructions. See the *High Availability Agent Pack Getting Started Guide* for a list of third-party replication technologies that VCS supports.

Configuring clusters for global cluster setup

Perform the following steps to configure the clusters for disaster recovery:

- Configure global cluster components at the primary site
See [“Configuring global cluster components at the primary site”](#) on page 571.
- Install and configure VCS at the secondary site
See [“Installing and configuring VCS at the secondary site”](#) on page 573.
- Secure communication between the wide-area connectors
See [“Securing communication between the wide-area connectors”](#) on page 573.
- Configure remote cluster objects
See [“Configuring remote cluster objects”](#) on page 575.
- Configure additional heartbeat links (optional)
See [“Configuring additional heartbeat links \(optional\)”](#) on page 575.
- Configure the Steward process (optional)
See [“Configuring the Steward process \(optional\)”](#) on page 575.

Configuring global cluster components at the primary site

Perform the following steps to configure global cluster components at the primary site.

If you have already completed these steps during the VCS cluster configuration at the primary site, then proceed to the next task to set up a VCS cluster at the secondary site.

See [“Installing and configuring VCS at the secondary site”](#) on page 573.

Run the GCO Configuration wizard to create or update the ClusterService group. The wizard verifies your configuration and validates it for a global cluster setup.

See [“About installing a VCS license”](#) on page 179.

To configure global cluster components at the primary site

- 1 Start the GCO Configuration wizard.

```
# gcoconfig
```

The wizard discovers the NIC devices on the local system and prompts you to enter the device to be used for the global cluster.

- 2 Specify the name of the device and press Enter.

- 3 If you do not have NIC resources in your configuration, the wizard asks you whether the specified NIC will be the public NIC used by all systems.

Enter **y** if it is the public NIC; otherwise enter **n**. If you entered **n**, the wizard prompts you to enter the names of NICs on all systems.

- 4 Enter the virtual IP to be used for the global cluster.

You must use either IPv4 or IPv6 address. VCS does not support configuring clusters that use different Internet Protocol versions in a global cluster.

- 5 If you do not have IP resources in your configuration, the wizard does the following:

- For IPv4 address:

The wizard prompts you for the netmask associated with the virtual IP. The wizard detects the netmask; you can accept the suggested value or enter another value.

- For IPv6 address:

The wizard prompts you for the prefix associated with the virtual IP.

- 6 The wizard prompts for the values for the network hosts. Enter the values.

- 7 The wizard starts running commands to create or update the ClusterService group. Various messages indicate the status of these commands. After running these commands, the wizard brings the ClusterService group online.

- 8 Verify that the gcoip resource that monitors the virtual IP address for inter-cluster communication is online.

```
# hares -state gcoip
```

Installing and configuring VCS at the secondary site

Perform the following steps to set up a VCS cluster at the secondary site.

To install and configure VCS at the secondary site

- 1 At the secondary site, install and configure VCS cluster.

Note the following points for this task:

- During VCS configuration, answer the prompts to configure global cluster. This step configures the virtual IP for inter-cluster communication.

See the *Cluster Server Configuration and Upgrade Guide* for instructions.

- 2 Verify that the `gcoip` resource that monitors the virtual IP address for inter-cluster communication is online.

```
# hares -state gcoip
```

Securing communication between the wide-area connectors

Perform the following steps to configure secure communication between the wide-area connectors.

To secure communication between the wide-area connectors

- 1 Verify that security is configured in both the clusters. You can use the `installvcs -security` command to configure security.

For more information, see the *Cluster Server Configuration and Upgrade Guide*.

- 2 Establish trust between the clusters.

For example in a VCS global cluster environment with two clusters, perform the following steps to establish trust between the clusters:

- On each node of the first cluster, enter the following command:

```
# export EAT_DATA_DIR=/var/VRTSvcs/vcsauth/data/WAC;  
/opt/VRTSvcs/bin/vcsat setuptrust -b  
IP_address_of_any_node_from_the_second_cluster:14149 -s high
```

The command obtains and displays the security certificate and other details of the root broker of the second cluster.

If the details are correct, enter `y` at the command prompt to establish trust.

For example:

```
The hash of above credential is
b36a2607bf48296063068e3fc49188596aa079bb
Do you want to trust the above?(y/n) y
```

- On each node of the second cluster, enter the following command:

```
# export EAT_DATA_DIR=/var/VRTSvcs/vcsauth/data/WAC
/opt/VRTSvcs/bin/vcsat setuptrust -b
IP_address_of_any_node_from_the_first_cluster:14149 -s high
```

The command obtains and displays the security certificate and other details of the root broker of the first cluster.

If the details are correct, enter y at the command prompt to establish trust. Alternatively, if you have passwordless communication set up on the cluster, you can use the `installvcs -securitytrust` option to set up trust with a remote cluster.

- 3 ■ Skip the remaining steps in this procedure if you used the `installvcs -security` command after the global cluster was set up.
 - Complete the remaining steps in this procedure if you had a secure cluster and then used the `gcoconfig` command.

On each cluster, take the wac resource offline on the node where the wac resource is online. For each cluster, run the following command:

```
# hares -offline wac -sys node_where_wac_is_online
```

- 4 Update the values of the StartProgram and MonitorProcesses attributes of the wac resource:

```
# haconf -makerw
hares -modify wac StartProgram \
"/opt/VRTSvcs/bin/wacstart -secure"
hares -modify wac MonitorProcesses \
"/opt/VRTSvcs/bin/wac -secure"
haconf -dump -makero
```

- 5 On each cluster, bring the wac resource online. For each cluster, run the following command on any node:

```
# hares -online wac -sys systemname
```

Configuring remote cluster objects

After you set up the VCS and replication infrastructure at both sites, you must link the two clusters. You must configure remote cluster objects at each site to link the two clusters. The Remote Cluster Configuration wizard provides an easy interface to link clusters.

To configure remote cluster objects

- ◆ Start the Remote Cluster Configuration wizard.

From Cluster Explorer, click **Edit > Add/Delete Remote Cluster**.

You must use the same IP address as the one assigned to the IP resource in the ClusterService group. Global clusters use this IP address to communicate and exchange ICMP heartbeats between the clusters.

See [“Adding a remote cluster”](#) on page 600.

Configuring additional heartbeat links (optional)

You can configure additional heartbeat links to exchange ICMP heartbeats between the clusters.

To configure an additional heartbeat between the clusters (optional)

- 1 On Cluster Explorer’s **Edit** menu, click **Configure Heartbeats**.
- 2 In the Heartbeat configuration dialog box, enter the name of the heartbeat and select the check box next to the name of the cluster.
- 3 Click the icon in the **Configure** column to open the Heartbeat Settings dialog box.
- 4 Specify the value of the Arguments attribute and various timeout and interval fields. Click **+** to add an argument value; click **-** to delete it.

If you specify IP addresses in the Arguments attribute, make sure the IP addresses have DNS entries.

- 5 Click **OK**.
- 6 Click **OK** in the Heartbeat configuration dialog box.

Now, you can monitor the state of both clusters from the Java Console.

Configuring the Steward process (optional)

In case of a two-cluster global cluster setup, you can configure a Steward to prevent potential split-brain conditions, provided the proper network infrastructure exists.

See [“About the Steward process: Split-brain in two-cluster global clusters”](#) on page 564.

To configure the Steward process for clusters not running in secure mode

- 1 Identify a system that will host the Steward process.
- 2 Make sure that both clusters can connect to the system through a ping command.
- 3 Copy the file `steward` from a node in the cluster to the Steward system. The file resides at the following path:

```
/opt/VRTSvcs/bin/
```

- 4 In both clusters, set the Stewards attribute to the IP address of the system running the Steward process.

For example:

```
cluster cluster1938 (  
  UserNames = { admin = gNOgNInKOjOOmWOiNL }  
  ClusterAddress = "10.182.147.19"  
  Administrators = { admin }  
  CredRenewFrequency = 0  
  CounterInterval = 5  
  Stewards = {"10.212.100.165"}  
)
```

- 5 On the system designated to host the Steward, start the Steward process:

```
# steward -start
```

To configure the Steward process for clusters running in secure mode

- 1 Verify that the prerequisites for securing Steward communication are met.

See “[Prerequisites for clusters running in secure mode](#)” on page 568.

To verify that the `wac` process runs in secure mode, do the following:

- Check the value of the `wac` resource attributes:

```
# hares -value wac StartProgram
```

The value must be “`/opt/VRTSvcs/bin/wacstart -secure.`”

```
# hares -value wac MonitorProcesses
```

The value must be “`/opt/VRTSvcs/bin/wac -secure.`”

- List the `wac` process:

```
# ps -ef | grep wac
```

The wac process must run as “/opt/VRTSvcs/bin/wac –secure.”

- 2 Identify a system that will host the Steward process.
- 3 Make sure that both clusters can connect to the system through a ping command.
- 4 Perform this step *only* if VCS is not already installed on the Steward system. If VCS is already installed, skip to step 5.
 - If the cluster UUID is not configured, configure it by using `/opt/VRTSvcs/bin/uuidconfig.pl`.
 - On the system that is designated to run the Steward process, run the `installvcs -securityonnode` command.

The installer prompts for a confirmation if VCS is not configured or if VCS is not running on all nodes of the cluster. Enter **y** when the installer prompts whether you want to continue configuring security.

For more information about the `-securityonnode` option, see the *Cluster Server Configuration and Upgrade Guide*.

- 5 Generate credentials for the Steward using `/opt/VRTSvcs/bin/steward_secure.pl` or perform the following steps:

```
# unset EAT_DATA_DIR

# unset EAT_HOME_DIR

# /opt/VRTSvcs/bin/vcsauth/vcsauthserver/bin/vssat createpd -d
VCS_SERVICES -t ab

# /opt/VRTSvcs/bin/vcsauth/vcsauthserver/bin/vssat addprpl -t ab
-d VCS_SERVICES -p STEWARD -s password

# mkdir -p /var/VRTSvcs/vcsauth/data/STEWARD

# export EAT_DATA_DIR=/var/VRTSvcs/vcsauth/data/STEWARD

# /opt/VRTSvcs/bin/vcsat setuptrust -s high -b localhost:14149
```

- 6 Set up trust on all nodes of the GCO clusters:

```
# export EAT_DATA_DIR=/var/VRTSvcs/vcsauth/data/WAC

# vcsat setuptrust -b <IP_of_Steward>:14149 -s high
```

7 Set up trust on the Steward:

```
# export EAT_DATA_DIR=/var/VRTSvcs/vcsauth/data/STEWARD
# vcsat setuptrust -b <VIP_of_remote_cluster1>:14149 -s high
# vcsat setuptrust -b <VIP_of_remote_cluster2>:14149 -s high
```

8 In both the clusters, set the Stewards attribute to the IP address of the system running the Steward process.

For example:

```
cluster cluster1938 (
  UserNames = { admin = gNOgNInKOjOOmWOiNL }
  ClusterAddress = "10.182.147.19"
  Administrators = { admin }
  CredRenewFrequency = 0
  CounterInterval = 5
  Stewards = {"10.212.100.165"}
}
```

9 On the system designated to run the Steward, start the Steward process:

```
# /opt/VRTSvcs/bin/steward -start -secure
```

To stop the Steward process

- ◆ To stop the Steward process that is not configured in secure mode, open a new command window and run the following command:

```
# steward -stop
```

To stop the Steward process running in secure mode, open a new command window and run the following command:

```
# steward -stop -secure
```

Configuring service groups for global cluster setup

Perform the following steps to configure the service groups for disaster recovery.

To configure service groups

- 1** At the secondary site, set up the application for high availability.
Configure VCS service groups for the application. Create a configuration that is similar to the one in the first cluster.

- You can do this by either using Cluster Manager (Java Console) to copy and paste resources from the primary cluster, or by copying the configuration from the main.cf file in the primary cluster to the secondary cluster.
 - Make appropriate changes to the configuration. For example, you must modify the SystemList attribute to reflect the systems in the secondary cluster.
 - Make sure that the name of the service group (appgroup) is identical in both clusters.
- 2 To assign remote administration privileges to users for remote cluster operations, configure users with the same name and privileges on both clusters. See [“User privileges for cross-cluster operations”](#) on page 85.
 - 3 If your setup uses BIND DNS, add a resource of type DNS to the application service group at each site.
Refer to the *Cluster Server Bundled Agent’s Reference Guide* for more details.
 - 4 At each site, perform the following depending on the replication technology you have set up:
 - Volume Replicator
Configure VCS to manage and monitor Replicated Volume Groups (RVGs). See [“Configuring VCS service group for VVR-based replication”](#) on page 579.
 - A supported third-party replication technology
Install and configure the corresponding VCS agent for replication. See the Installation and Configuration Guide for the corresponding VCS replication agent for instructions.

Configuring VCS service group for VVR-based replication

Perform the following steps to configure VCS to monitor Volume Replicator (VVR). Then, set an online local hard group dependency from application service group (appgroup) to replication service group (appgroup_rep) to ensure that the service groups fail over and switch together.

To create the RVG resources in VCS

- 1 Create a new service group, say appgroup_rep.
- 2 Copy the DiskGroup resource from the appgroup to the new group.
- 3 Configure new resources of type IP and NIC in the appgroup_rep service group. The IP resource monitors the virtual IP that VVR uses for replication.
- 4 Configure a new resource of type RVG in the new (appgroup_rep) service group.

5 Configure the RVG resource.

See the *Veritas InfoScale™ Replication Administrator's Guide* for more information about the resource.

Note that the RVG resource starts, stops, and monitors the RVG in its current state and does not promote or demote VVR when you want to change the direction of replication. That task is managed by the RVGPrimary agent.

6 Set dependencies as per the following information:

- RVG resource depends on the IP resource.
- RVG resource depends on the DiskGroup resource.
- IP resource depends on the NIC resource.

The service group now looks like:

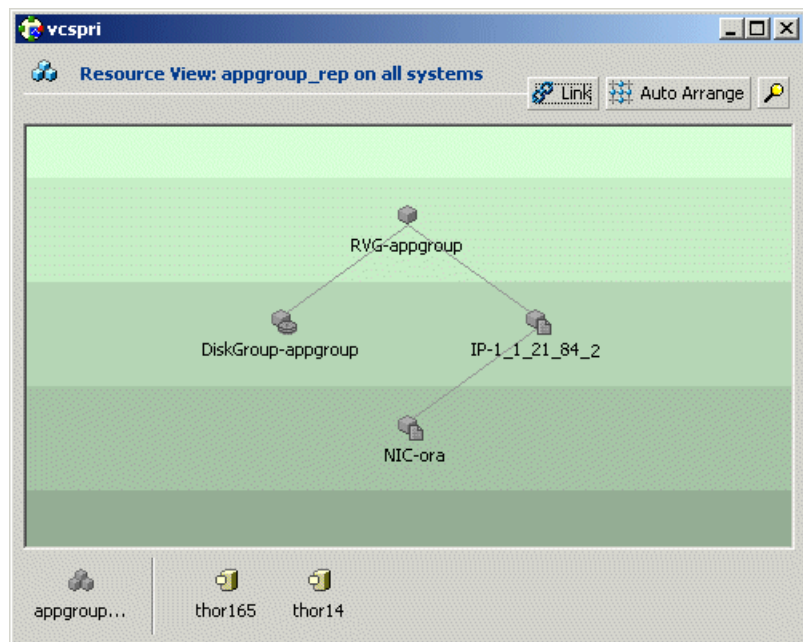

7 Delete the DiskGroup resource from the appgroup service group.

- 8 In the application service group (appgroup), add a resource of type RVGPrimary and configure its attributes.

See the *Veritas InfoScale™ Replication Administrator's Guide* for more information about the resource.

- 9 Set resource dependencies such that the Mount resource depends on the RVGPrimary resource.

The appgroup now looks like:

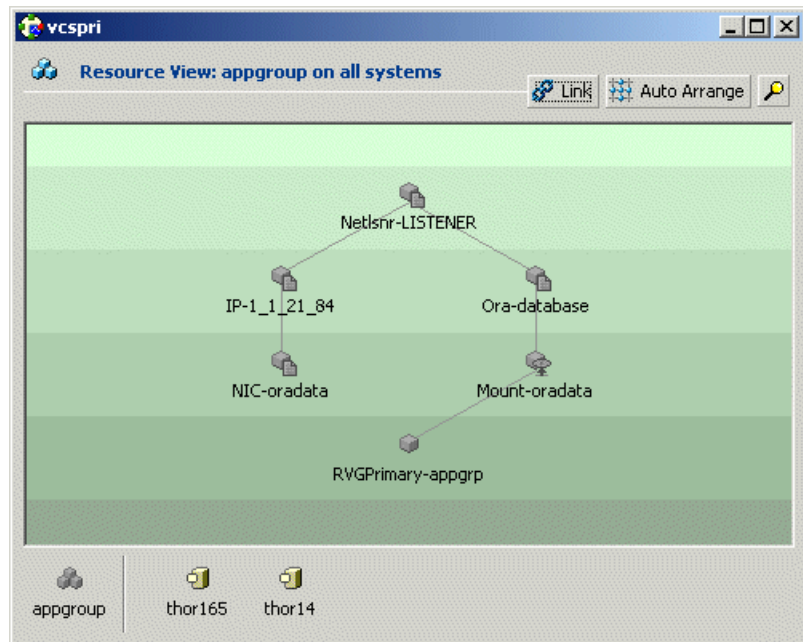

To link the application and replication service groups

- 1 In the Cluster Explorer configuration tree, click the cluster name.
- 2 In the view panel, click the **Service Groups** tab.
This opens the service group dependency graph.
- 3 Click **Link**.
- 4 Click the parent group, appgroup, and move the mouse toward the child group, appgroup_rep.

- 5 Click the child group appgroup_rep.
- 6 In the Link Service Groups dialog box, click the online local relationship and the hard dependency type and click **OK**.

Configuring a service group as a global service group

Run the Global Group Configuration wizard to configure the application service group (appgroup) as a global group.

To create the global service group

- 1 In the service group tree of Cluster Explorer, right-click the application service group (appgroup).
- 2 Select **Configure As Global** from the menu.
- 3 Enter the details of the service group to modify (appgroup).
- 4 From the **Available Clusters** box, click the clusters on which the group can come online. The local cluster is not listed as it is implicitly defined to be part of the ClusterList. Click the right arrow to move the cluster name to the **ClusterList** box.
- 5 Select the policy for cluster failover:
 - **Manual** prevents a group from automatically failing over to another cluster.
 - **Auto** enables a group to automatically fail over to another cluster if it is unable to fail over within the cluster, or if the entire cluster faults.
 - **Connected** enables a group to automatically fail over to another cluster if it is unable to fail over within the cluster.
- 6 Click **Next**.
- 7 Enter or review the connection details for each cluster.

Click the **Configure** icon to review the remote cluster information for each cluster.
- 8 Enter the IP address of the remote cluster, the IP address of a cluster system, or the host name of a cluster system.
- 9 Enter the user name and the password for the remote cluster and click **OK**.
- 10 Click **Next**.
- 11 Click **Finish**.
- 12 Save the configuration.

The appgroup service group is now a global group and can be failed over between clusters.

About cluster faults

In the global cluster setup, consider a case where the primary cluster suffers a failure. The Oracle service group cannot fail over in the local cluster and must fail over globally, to a node in another cluster.

In this situation, VCS sends an alert indicating that the cluster is down.

An administrator can bring the group online in the remote cluster.

The RVGPrimary agent ensures that Volume Replicator volumes are made writable and the DNS agent ensures that name services are resolved to the remote site. The application can be started at the remote site.

About the type of failure

If a disaster disables all processing power in your primary data center, heartbeats from the failover site to the primary data center fail. VCS sends an alert signalling cluster failure. If you choose to take action on this failure, VCS prompts you to declare the type of failure.

You can choose one of the following options to declare the failure:

- Disaster, implying permanent loss of the primary data center
- Outage, implying the primary may return to its current form in some time
- Disconnect, implying a split-brain condition; both clusters are up, but the link between them is broken
- Replica, implying that data on the takeover target has been made consistent from a backup source and that the RVGPrimary can initiate a takeover when the service group is brought online. This option applies to Volume Replicator environments only.

You can select the groups to be failed over to the local cluster, in which case VCS brings the selected groups online on a node based on the group's FailOverPolicy attribute. It also marks the groups as being OFFLINE in the other cluster. If you do not select any service groups to fail over, VCS takes no action except implicitly marking the service groups as offline in the failed cluster.

Switching the service group back to the primary

You can switch the service group back to the primary after resolving the fault at the primary site. Before switching the application to the primary site, you must resynchronize any changed data from the active Secondary site since the failover. This can be done manually through Volume Replicator or by running a VCS action from the RVGPrimary resource.

To switch the service group when the primary site has failed and the secondary did a takeover

- 1 In the **Service Groups** tab of the configuration tree, right-click the resource.
- 2 Click **Actions**.
- 3 Specify the details of the action:
 - From the **Action** list, choose **fbsync**.
 - Click the system on which to execute the action.
 - Click **OK**.

This begins a fast-failback of the replicated data set. You can monitor the value of the `ResourceInfo` attribute for the RVG resource to determine when the resynchronization has completed.
- 4 Once the resynchronization completes, switch the service group to the primary cluster.
 - In the **Service Groups** tab of the Cluster Explorer configuration tree, right-click the service group.
 - Click **Switch To**, and click **Remote switch**.
 - In the Switch global group dialog box, click the cluster to switch the group. Click the specific system, or click **Any System**, and click **OK**.

About setting up a disaster recovery fire drill

The disaster recovery fire drill procedure tests the fault-readiness of a configuration by mimicking a failover from the primary site to the secondary site. This procedure is done without stopping the application at the primary site and disrupting user access, interrupting the flow of replicated data, or causing the secondary site to need resynchronization.

The initial steps to create a fire drill service group on the secondary site that closely follows the configuration of the original application service group and contains a point-in-time copy of the production data in the Replicated Volume Group (RVG). Bringing the fire drill service group online on the secondary site demonstrates the ability of the application service group to fail over and come online at the secondary site, should the need arise. Fire drill service groups do not interact with outside clients or with other instances of resources, so they can safely come online even when the application service group is online.

You must conduct a fire drill only at the secondary site; do not bring the fire drill service group online on the node hosting the original application.

You can override the FireDrill attribute and make fire drill resource-specific.

Before you perform a fire drill in a disaster recovery setup that uses Volume Replicator, perform the following steps:

- Configure the fire drill service group.
 - See [“About creating and configuring the fire drill service group manually”](#) on page 585.
 - See [“About configuring the fire drill service group using the Fire Drill Setup wizard”](#) on page 588.
- If you configure the fire drill service group manually using the command line or the Cluster Manager (Java Console), set an offline local dependency between the fire drill service group and the application service group to make sure a fire drill does not block an application failover in case a disaster strikes the primary site. If you use the Fire Drill Setup (fdsetup) wizard, the wizard creates this dependency.
- Set the value of the ReuseMntPt attribute to 1 for all Mount resources.
- After the fire drill service group is taken offline, reset the value of the ReuseMntPt attribute to 0 for all Mount resources.

VCS also supports HA fire drills to verify a resource can fail over to another node in the cluster.

See [“About testing resource failover by using HA fire drills”](#) on page 298.

Note: You can conduct fire drills only on regular VxVM volumes; volume sets (vset) are not supported.

VCS provides hardware replication agents for array-based solutions, such as Hitachi Truecopy, EMC SRDF, and so on . If you are using hardware replication agents to monitor the replicated data clusters, refer to the VCS replication agent documentation for details on setting up and configuring fire drill.

About creating and configuring the fire drill service group manually

You can create the fire drill service group using the command line or Cluster Manager (Java Console.) The fire drill service group uses the duplicated copy of the application data.

Creating and configuring the fire drill service group involves the following tasks:

- See [“Creating the fire drill service group”](#) on page 586.
- See [“Linking the fire drill and replication service groups”](#) on page 587.
- See [“Adding resources to the fire drill service group”](#) on page 587.

- See “[Configuring the fire drill service group](#)” on page 587.
- See “[Enabling the FireDrill attribute](#)” on page 588.

Creating the fire drill service group

This section describes how to use the Cluster Manager (Java Console) to create the fire drill service group and change the failover attribute to false so that the fire drill service group does not failover to another node during a test.

To create the fire drill service group

- 1 Open the Veritas Cluster Manager (Java Console). (**Start > All Programs > Veritas > Veritas Cluster Manager - Java Console**)
On Windows 2012 operating systems, use the **Apps** menu.
- 2 Log on to the cluster and click **OK**.
- 3 Click the **Service Group** tab in the left pane and click the **Resources** tab in the right pane.
- 4 Right-click the cluster in the left pane and click **Add Service Group**.
- 5 In the **Add Service Group** dialog box, provide information about the new service group.
 - In Service Group name, enter a name for the fire drill service group
 - Select systems from the Available Systems box and click the arrows to add them to the Systems for Service Group box.
 - Click **OK**.

To disable the AutoFailOver attribute

- 1 Click the **Service Group** tab in the left pane and select the fire drill service group.
- 2 Click the **Properties** tab in the right pane.
- 3 Click the **Show all attributes** button.
- 4 Double-click the **AutoFailOver** attribute.
- 5 In the **Edit Attribute** dialog box, clear the **AutoFailOver** check box.
- 6 Click **OK** to close the **Edit Attribute** dialog box.
- 7 Click the **Save and Close Configuration** icon in the tool bar.

Linking the fire drill and replication service groups

Create an online local firm dependency link between the fire drill service group and the replication service group.

To link the service groups

- 1 In Cluster Explorer, click the System tab in the left pane and click the **Service Groups** tab in the right pane.
- 2 Click **Link**.
- 3 Click the fire drill service group, drag the link and click the replication service group.
- 4 Define the dependency. Choose the **online local** and **firm** options and click **OK**.

Adding resources to the fire drill service group

Add resources to the new fire drill service group to recreate key aspects of the application service group.

To add resources to the service group

- 1 In Cluster Explorer, click the **Service Group** tab in the left pane, click the application service group and click the **Resources** tab in the right pane.
- 2 Right-click the resource at the top of the tree, select **Copy** and click **Self and Child Nodes**.
- 3 In the left pane, click the fire drill service group.
- 4 Right-click the right pane, and click **Paste**.
- 5 In the Name Clashes dialog box, specify a way for the resource names to be modified, for example, insert an FD_ prefix. Click **Apply**.
- 6 Click **OK**.

Configuring the fire drill service group

After copying resources to the fire drill service group, edit the resources so they will work properly with the duplicated data. The attributes must be modified to reflect the configuration at the remote site. Bringing the service group online without modifying resource attributes is likely to result in a cluster fault and interruption in service.

To configure the service group

- 1 In Cluster Explorer, click the **Service Group** tab in the left pane, click the fire drill service group in the left pane and click the **Resources** tab in the right pane.
- 2 Right-click the RVGPrimary resource and click **Delete**.
- 3 Right-click the resource to be edited and click **View > Properties View**. If a resource to be edited does not appear in the pane, click **Show All Attributes**.
- 4 Edit attributes to reflect the configuration at the remote site. For example, change the MountV resources so that they point to the volumes used in the fire drill service group. Similarly, reconfigure the DNS and IP resources.

Enabling the FireDrill attribute

You must edit certain resource types so they are FireDrill-enabled. Making a resource type FireDrill-enabled changes the way that VCS checks for concurrency violations. Typically, when FireDrill is not enabled, resources can not come online on more than one node in a cluster at a time. This behavior prevents multiple nodes from using a single resource or from answering client requests. Fire drill service groups do not interact with outside clients or with other instances of resources, so they can safely come online even when the application service group is online.

Typically, you would enable the FireDrill attribute for the resource type used the configure the agent. For example, in a service group monitoring SQL Server 2008, enable the FireDrill attribute for the SQLServer2008 and the SQLFilestream resource types.

To enable the FireDrill attribute

- 1 In Cluster Explorer, click the **Types** tab in the left pane, right-click the type to be edited, and click **View > Properties View**.
- 2 Click **Show All Attributes**.
- 3 Double click **FireDrill**.
- 4 In the **Edit Attribute** dialog box, enable **FireDrill** as required, and click **OK**.
Repeat the process of enabling the FireDrill attribute for all required resource types.

About configuring the fire drill service group using the Fire Drill Setup wizard

Use the Fire Drill Setup Wizard to set up the fire drill configuration.

The wizard performs the following specific tasks:

- Creates a Cache object to store changed blocks during the fire drill, which minimizes disk space and disk spindles required to perform the fire drill.
- Configures a VCS service group that resembles the real application group.

The wizard works only with application groups that contain one disk group. The wizard sets up the first RVG in an application. If the application has more than one RVG, you must create space-optimized snapshots and configure VCS manually, using the first RVG as reference.

You can schedule the fire drill for the service group using the `fdsched` script.

See [“Scheduling a fire drill”](#) on page 591.

Running the fire drill setup wizard

To run the wizard

- 1 Start the RVG Secondary Fire Drill wizard on the Volume Replicator secondary site, where the application service group is offline and the replication group is online as a secondary:

```
# /opt/VRTSvcs/bin/fdsetup
```

- 2 Read the information on the Welcome screen and press the **Enter** key.
- 3 The wizard identifies the global service groups. Enter the name of the service group for the fire drill.
- 4 Review the list of volumes in disk group that could be used for a space-optimized snapshot. Enter the volumes to be selected for the snapshot. Typically, all volumes used by the application, whether replicated or not, should be prepared, otherwise a snapshot might not succeed.

Press the **Enter** key when prompted.

- 5 Enter the cache size to store writes when the snapshot exists. The size of the cache must be large enough to store the expected number of changed blocks during the fire drill. However, the cache is configured to grow automatically if it fills up. Enter disks on which to create the cache.

Press the **Enter** key when prompted.

- 6 The wizard starts running commands to create the fire drill setup.

Press the **Enter** key when prompted.

The wizard creates the application group with its associated resources. It also creates a fire drill group with resources for the application (Oracle, for example), the Mount, and the RVGSnapshot types.

The application resources in both service groups define the same application, the same database in this example. The wizard sets the FireDrill attribute for the application resource to 1 to prevent the agent from reporting a concurrency violation when the actual application instance and the fire drill service group are online at the same time.

About configuring local attributes in the fire drill service group

The fire drill setup wizard does not recognize localized attribute values for resources. If the application service group has resources with local (per-system) attribute values, you must manually set these attributes after running the wizard.

Verifying a successful fire drill

If you configured the fire drill service group manually using the command line or the Cluster Manager (Java Console), make sure that you set an offline local dependency between the fire drill service group and the application service group. This dependency ensures that a fire drill does not block an application failover in case a disaster strikes the primary site.

Bring the fire drill service group online on a node that does not have the application running. Verify that the fire drill service group comes online. This action validates that your disaster recovery solution is configured correctly and the production service group will fail over to the secondary site in the event of an actual failure (disaster) at the primary site.

If the fire drill service group does not come online, review the VCS engine log to troubleshoot the issues so that corrective action can be taken as necessary in the production service group.

You can also view the fire drill log, located at `/tmp/fd-servicegroup.pid`

Remember to take the fire drill offline once its functioning has been validated. Failing to take the fire drill offline could cause failures in your environment. For example, if the application service group were to fail over to the node hosting the fire drill service group, there would be resource conflicts, resulting in both service groups faulting.

Scheduling a fire drill

You can schedule the fire drill for the service group using the `fdsched` script. The `fdsched` script is designed to run only on the lowest numbered node that is currently running in the cluster. The scheduler runs the command `hagrp - online firedrill_group -any` at periodic intervals.

To schedule a fire drill

- 1 Add the file `/opt/VRTSvcs/bin/fdsched` to your crontab.
- 2 To make fire drills highly available, add the `fdsched` file to each node in the cluster.

Multi-tiered application support using the RemoteGroup agent in a global environment

Figure 18-5 represents a two-site, two-tier environment. The application cluster, which is globally clustered between L.A. and Denver, has cluster dependencies up and down the tiers. Cluster 1 (C1), depends on the remote service group for cluster 3 (C3). At the same time, cluster 2 (C2) also depends on the remote service group for cluster 4 (C4).

Multi-tiered application support using the RemoteGroup agent in a global environment

Figure 18-5 A VCS two-tiered globally clustered application and database

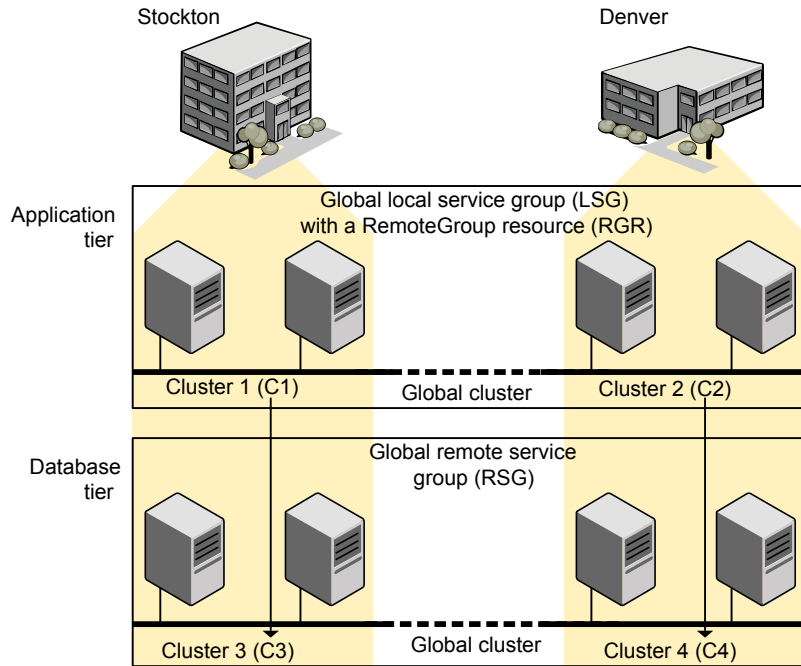

Just as a two-tier, two-site environment is possible, you can also tie a three-tier environment together.

Figure 18-6 represents a two-site, three-tier environment. The application cluster, which is globally clustered between L.A. and Denver, has cluster dependencies up and down the tiers. Cluster 1 (C1), depends on the RemoteGroup resource on the DB tier for cluster 3 (C3), and then on the remote service group for cluster 5 (C5). The stack for C2, C4, and C6 functions the same.

Figure 18-6 A three-tiered globally clustered application, database, and storage

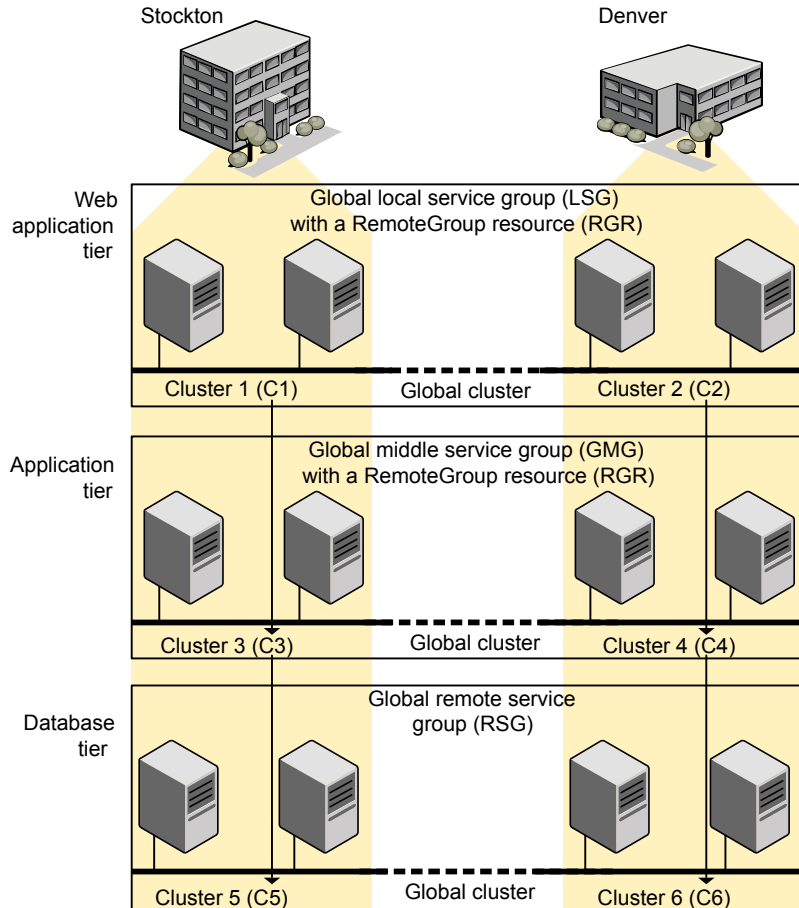

Test scenario for a multi-tiered environment

In the following scenario, eight systems reside in four clusters. Each tier contains a global cluster. The global local service group in the top tier depends on the global remote service group in the bottom tier.

The following main.cf files show this multi-tiered environment. The FileOnOff resource is used to test the dependencies between layers. Note that some attributes have been edited for clarity, and that these clusters are not running in secure mode.

Figure 18-7 shows the scenario for testing.

Figure 18-7 A VCS two-tiered globally clustered scenario

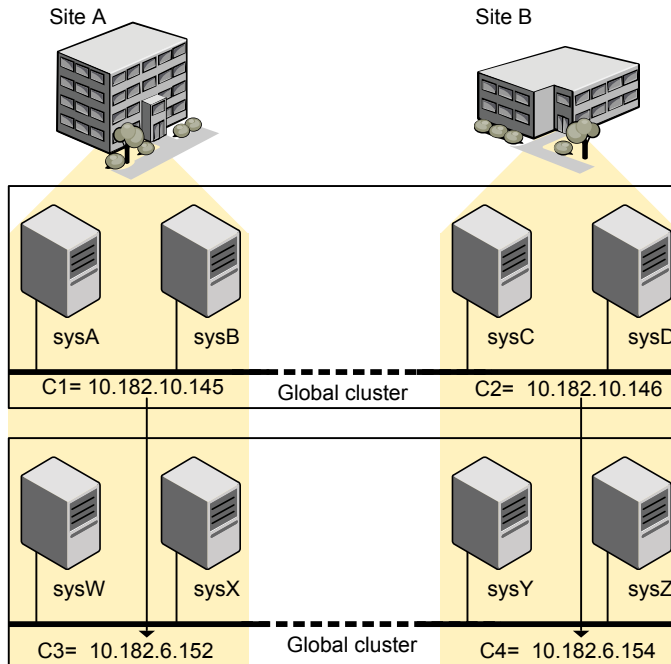

About the main.cf file for cluster 1

The contents of the main.cf file for cluster 1 (C1) in the top tier, containing the sysA and sysB nodes.

```
include "types.cf"

cluster C1 (
    ClusterAddress = "10.182.10.145"
)

remotecluster C2 (
    ClusterAddress = "10.182.10.146"
)

heartbeat Icmp (
    ClusterList = { C2 }
    AYATimeout = 30
    Arguments @C2 = { "10.182.10.146" }
```

```
)

system sysA (
)

system sysB (
)

group LSG (
    SystemList = { sysA = 0, sysB = 1 }
    ClusterList = { C2 = 0, C1 = 1 }
    AutoStartList = { sysA, sysB }
    ClusterFailOverPolicy = Auto
)

FileOnOff filec1 (
    PathName = "/tmp/c1"
)

RemoteGroup RGR (
    IPAddress = "10.182.6.152"
    // The above IPAddress is the highly available address of C3-
    // the same address that the wac uses
    Username = root
    Password = xxxyyy
    GroupName = RSG
    VCSSysName = ANY
    ControlMode = OnOff
)
```

About the main.cf file for cluster 2

The contents of the main.cf file for cluster 2 (C2) in the top tier, containing the sysC and sysD nodes.

```
include "types.cf"

cluster C2 (
    ClusterAddress = "10.182.10.146"
)

remotecluster C1 (
    ClusterAddress = "10.182.10.145"
```

```
)

heartbeat Icmp (
    ClusterList = { C1 }
    AYATimeout = 30
    Arguments @C1 = { "10.182.10.145" }
)

system sysC (
)

system sysD (
)

group LSG (
    SystemList = { sysC = 0, sysD = 1 }
    ClusterList = { C2 = 0, C1 = 1 }
    Authority = 1
    AutoStartList = { sysC, sysD }
    ClusterFailOverPolicy = Auto
)

FileOnOff filec2 (
    PathName = filec2
)

RemoteGroup RGR (
    IPAddress = "10.182.6.154"
    // The above IPAddress is the highly available address of C4-
    // the same address that the wac uses
    Username = root
    Password = vvvyyy
    GroupName = RSG
    VCSSysName = ANY
    ControlMode = OnOff
)
```

About the main.cf file for cluster 3

The contents of the main.cf file for cluster 3 (C3) in the bottom tier, containing the sysW and sysX nodes.

```
include "types.cf"

cluster C3 (
    ClusterAddress = "10.182.6.152"
)

remotecluster C4 (
    ClusterAddress = "10.182.6.154"
)

heartbeat Icmp (
    ClusterList = { C4 }
    AYATimeout = 30
    Arguments @C4 = { "10.182.6.154" }
)

system sysW (
)

system sysX (
)

group RSG (
    SystemList = { sysW = 0, sysX = 1 }
    ClusterList = { C3 = 1, C4 = 0 }
    AutoStartList = { sysW, sysX }
    ClusterFailOverPolicy = Auto
)

FileOnOff filec3 (
    PathName = "/tmp/filec3"
)
```

About the main.cf file for cluster 4

The contents of the main.cf file for cluster 4 (C4) in the bottom tier, containing the sysY and sysZ nodes.

```
include "types.cf"

cluster C4 (
    ClusterAddress = "10.182.6.154"
)
```

```
remotecluster C3 (  
    ClusterAddress = "10.182.6.152"  
)  
  
heartbeat Icmp (  
    ClusterList = { C3 }  
    AYATimeout = 30  
    Arguments @C3 = { "10.182.6.152" }  
)  
  
system sysY (  
)  
  
system sysZ (  
)  
  
group RSG (  
    SystemList = { sysY = 0, sysZ = 1 }  
    ClusterList = { C3 = 1, C4 = 0 }  
    Authority = 1  
    AutoStartList = { sysY, sysZ }  
    ClusterFailOverPolicy = Auto  
)  
  
FileOnOff filec4 (  
    PathName = "/tmp/filec4"  
)
```

Administering global clusters from Cluster Manager (Java console)

This chapter includes the following topics:

- [About global clusters](#)
- [Adding a remote cluster](#)
- [Deleting a remote cluster](#)
- [Administering global service groups](#)
- [Administering global heartbeats](#)

About global clusters

The process of creating a global cluster environment involves creating a common service group for specified clusters, making sure all the service groups are capable of being brought online in the specified clusters, connecting the standalone clusters, and converting the service group that is common to all the clusters to a global service group. Use the console to add and delete remote clusters, create global service groups, and manage cluster heartbeats.

Creating a global cluster environment requires the following conditions:

- All service groups are properly configured and able to come online.
- The service group that will serve as the global group has the same unique name across all applicable clusters.
- The clusters must use the same version of VCS.

- The clusters must use the same operating system.
- The clusters are standalone and do not already belong to a global cluster environment.

Through the Java Console, you can simulate the process of generating and clearing global cluster faults in an OFFLINE state. Use VCS Simulator to complete these operations.

See [“About VCS Simulator”](#) on page 300.

For remote cluster operations, you must configure a VCS user with the same name and privileges in each cluster.

See [“User privileges for cross-cluster operations”](#) on page 85.

Adding a remote cluster

Cluster Explorer provides a wizard to create global clusters by linking standalone clusters. Command Center only enables you to perform remote cluster operations on the local cluster.

- If you are creating a global cluster environment for the first time with two standalone clusters, run the wizard from either of the clusters.
- If you are adding a standalone cluster to an existing global cluster environment, run the wizard from a cluster already in the global cluster environment.

The following information is required for the Remote Cluster Configuration Wizard in Cluster Explorer:

- The active host name or IP address of each cluster in the global configuration and of the cluster being added to the configuration.
- The user name and password of the administrator for each cluster in the configuration.
- The user name and password of the administrator for the cluster being added to the configuration.

Note: Veritas InfoScale products do not support adding a cluster that is already part of a global cluster environment. To merge the clusters of one global cluster environment (for example, cluster A and cluster B) with the clusters of another global environment (for example, cluster C and cluster D), separate cluster C and cluster D into standalone clusters and add them one by one to the environment containing cluster A and cluster B.

To add a remote cluster to a global cluster environment in Cluster Explorer

- 1 Do one of the following to add a remote cluster to a global cluster environment in Cluster Explorer:

From Cluster Explorer, click **Add/Delete Remote Cluster** on the **Edit** menu.

or

From the Cluster Explorer configuration tree, right-click the cluster name, and click **Add/Delete Remote Clusters**.

- 2 Review the required information for the **Remote Cluster Configuration Wizard** and click **Next**.

- 3 In the Wizard Options dialog box, click **Add Cluster** and then, click **Next**.

- 4 Enter the details of the new cluster:

If the cluster is not running in secure mode, do the following:



- Enter the host name of a cluster system, an IP address of a cluster system, or the IP address of the cluster that will join the global environment.
- Verify the port number.
- Enter the user name and the password.
- Click **Next**.

If the cluster is running in secure mode, do the following:

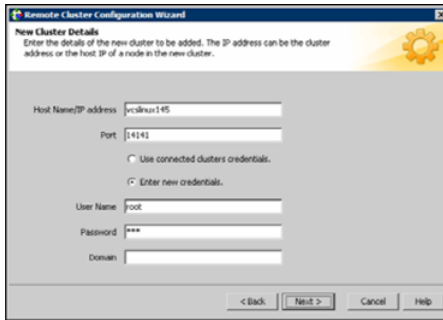

- Enter the host name of a cluster system, an IP address of a cluster system, or the IP address of the cluster that will join the global environment.
- Verify the port number.
- Choose to connect to the remote cluster with the credentials used for the current cluster connection or enter new credentials, including the user name, password, and the domain.
 If you have connected to the remote cluster using the wizard earlier, you can use the credentials from the previous connection.
 Click **Next**.

5 Enter the details of the existing remote clusters; this information on administrator rights enables the wizard to connect to all the clusters and make changes to the configuration.

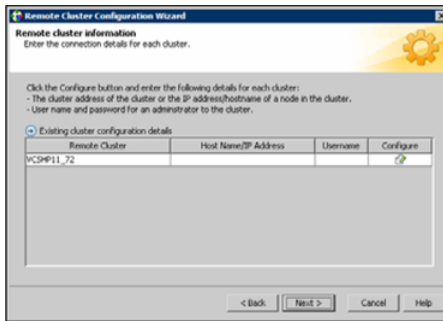

6 Click the **Configure** icon.

If the cluster is not running in secure mode, do the following:

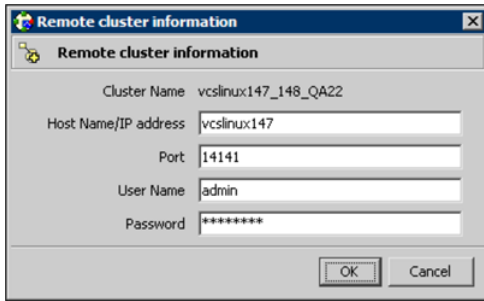

- Enter the host name of a cluster system, an IP address of a cluster system, or the IP address of the cluster that will join the global environment.
- Verify the port number.
- Enter the user name.
- Enter the password.
- Click **OK**.
- Repeat these steps for each cluster in the global environment.

If the cluster is running in secure mode, do the following:

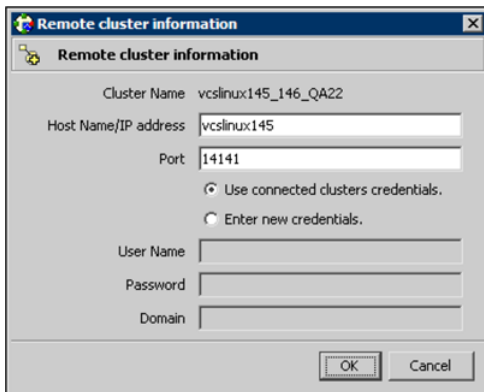

- Enter the host name of a cluster system, an IP address of a cluster system, or the IP address of the cluster that will join the global environment.
- Verify the port number.
- Choose to connect to the remote cluster with the credentials used for the current cluster connection or enter new credentials, including the user name, password, and the domain.

- Click **OK**.
- 7 Click **Next**.
 - 8 Click **Finish**. After running the wizard, the configurations on all the relevant clusters are opened and changed; the wizard does not close the configurations.
- To add a remote cluster to a global cluster environment in Command Center**
- 1 Click **Commands > Configuration > Cluster Objects > Add Remote Cluster**.
 - 2 Enter the name of the cluster.
 - 3 Enter the IP address of the cluster.
 - 4 Click **Apply**.

Note: Command Center enables you to perform operations on the local cluster; this does not affect the overall global cluster configuration.

Deleting a remote cluster

The Remote Cluster Configuration Wizard enables you to delete a remote cluster.

This operation involves the following tasks:

- Taking the ApplicationProcess resource configured to monitor the wac resource offline on the cluster that will be removed from the global environment. For example, to delete cluster C2 from a global environment containing C1 and C2, log on to C2 and take the wac resource offline.
- Removing the name of the specified cluster (C2) from the cluster lists of the other global groups using the Global Group Configuration Wizard. Note that the Remote Cluster Configuration Wizard in Cluster Explorer updates the cluster lists for heartbeats. Log on to the local cluster (C1) to complete this task before using the Global Group Configuration Wizard.
- Deleting the cluster (C2) from the local cluster (C1) using the Remote Cluster Configuration Wizard.

Note: You cannot delete a remote cluster if the cluster is part of a cluster list for global service groups or global heartbeats, or if the cluster is in the RUNNING, BUILD, INQUIRY, EXITING, or TRANSITIONING states.

To take the wac resource offline

- 1 From Cluster Monitor, log on to the cluster that will be deleted from the global cluster environment.
- 2 Do one of the following:

In the **Service Groups** tab of the Cluster Explorer configuration tree, right-click the **wac** resource under the **Application** type in the **ClusterService** group.

or

Click the ClusterService group in the configuration tree, click the **Resources** tab, and right-click the resource in the view panel.
- 3 Click **Offline**, and click the appropriate system from the menu.

To remove a cluster from a cluster list for a global group

- 1 From Cluster Explorer, click **Configure Global Groups** on the **Edit** menu.
- 2 Click **Next**.
- 3 Enter the details of the service group to modify, as follows:
 - Click the name of the service group.
 - For global to local cluster conversion, click the left arrow to move the cluster name from the cluster list back to the **Available Clusters** box.
 - Click **Next**.
- 4 Enter or review the connection details for each cluster. Click the **Configure** icon to review the remote cluster information for each cluster.

If the cluster is not running in secure mode, do the following:
 - Enter the IP address of the remote cluster, the IP address of a cluster system, or the host name of a cluster system.
 - Verify the port number.
 - Enter the user name.
 - Enter the password.
 - Click **OK**.
If the cluster is running in secure mode, do the following:
 - Enter the IP address of the remote cluster, the IP address of a cluster system, or the host name of a cluster system.
 - Verify the port number.

- Choose to connect to the remote cluster using the connected cluster's credentials or enter new credentials, including the user name, password, and the domain.
 - Click **OK**.
- 5 Click **Next**.
 - 6 Click **Finish**.

To delete a remote cluster from the local cluster

- 1 Do one of the following:
 From Cluster Explorer, click **Add/Delete Remote Cluster** on the **Edit** menu.
 or
 From the Cluster Explorer configuration tree, right-click the cluster name, and click **Add/Delete Remote Clusters**.
- 2 Review the required information for the **Remote Cluster Configuration Wizard** and click **Next**.
- 3 In the Wizard Options dialog box, click **Delete Cluster** and click **Next**:
- 4 In the Delete Cluster dialog box, click the name of the remote cluster to delete, and then click **Next**:
- 5 Review the connection details for each cluster. Click the **Configure** icon to review the remote cluster information for each cluster.

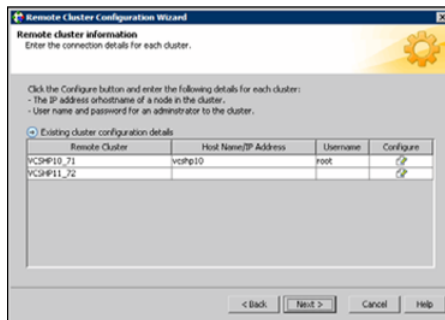

If the cluster is not running in secure mode, do the following:

- Enter the IP address of the remote cluster, the IP address of a cluster system, or the host name of a cluster system.
- Verify the port number.
- Enter the user name.

- Enter the password.
- Click **OK**.

If the cluster is running in secure mode, do the following:

- Enter the IP address of the remote cluster, the IP address of a cluster system, or the host name of a cluster system.
- Verify the port number.
- Choose to connect to the remote cluster with the credentials used for the current cluster connection or enter new credentials, including the user name, password, and the domain.
- If you have connected to the remote cluster using the wizard earlier, you can use the credentials from the previous connection.
- Click **OK**.

- 6 Click **Finish**.

Administering global service groups

After connecting clusters in a global cluster environment, use the Global Group Configuration Wizard to convert a local service group that is common to the global clusters to a global group. This wizard also enables you to convert global groups into local groups.

Administering global groups requires the following conditions:

- A group that will serve as the global group must have the same name across all applicable clusters.
- You must know the user name and password for the administrator for each cluster in the configuration.

Use Cluster Explorer to bring a global group online and take a global group offline on a remote cluster.

Converting local and global groups

Perform the following procedure to convert local and global groups.

To convert local and global groups

1 Do one of the following:

From Cluster Explorer, click **Configure Global Groups...** on the **Edit** menu.
 or

From the Cluster Explorer configuration tree, right-click the service group, click **Configure As Global...** or **Make Local...** and proceed to 3.

2 Review the information required for the Global Group Configuration Wizard and click **Next**.

3 Enter the details of the service group to modify:

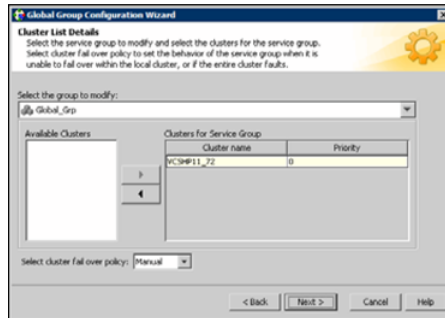

- Click the name of the service group that will be converted from a local group to a global group, or vice versa.
- From the **Available Clusters** box, click the clusters on which the group can come online. Click the right arrow to move the cluster name to the **Clusters for Service Group** box; for global to local cluster conversion, click the left arrow to move the cluster name back to the **Available Clusters** box. A priority number (starting with 0) indicates the cluster in which the group will attempt to come online. If necessary, double-click the entry in the **Priority** column to enter a new value.
- Select one of the following policies for cluster failover:
 - **Manual** prevents a group from automatically failing over to another cluster.
 - **Auto** enables a group to automatically fail over to another cluster if it is unable to fail over within the cluster, or if the entire cluster faults.
 - **Connected** enables a group to automatically fail over to another cluster if it is unable to fail over within the cluster.
- Click **Next**.

4 Enter or review the connection details for each cluster:

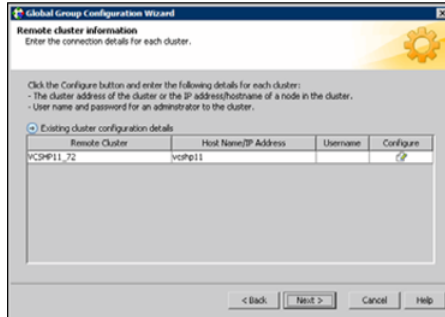

Click the **Configure** icon to review the remote cluster information for each cluster.

If the cluster is not running in secure mode, do the following:

- Enter the IP address of the remote cluster, the IP address of a cluster system, or the host name of a cluster system.
- Verify the port number.
- Enter the user name and password.
- Click **OK**.

Repeat these steps for each cluster in the global environment.

If the cluster is running in secure mode, do the following:

- Enter the IP address of the remote cluster, the IP address of a cluster system, or the host name of a cluster system.
- Verify the port number.
- Choose to connect to the remote cluster with the credentials used for the current cluster connection, or enter new credentials, including the user name, password, and the domain.

If you have connected to the remote cluster using the wizard earlier, you can use the credentials from the previous connection.

- Click **OK**.

Repeat these steps for each cluster in the global environment.

5 In the Remote cluster information dialog box, click **Next**.

6 Click **Finish**.

Bringing a service group online in a remote cluster

This topic describes how to bring a service group online in a remote cluster.

To bring a service group online in a remote cluster

1 Do the following:

In the **Service Groups** tab of the Cluster Explorer configuration tree of a local cluster, right-click the service group.

or

Click a local cluster in the configuration tree, click the **Service Groups** tab, and right-click the service group icon in the view panel.

2 Click **Online**, and click **Remote online...**

3 In the Online global group dialog box, do the following:

- Click the remote cluster to bring the group online.
- Click the specific system, or click **Any System**, to bring the group online.
- Click **OK**.

4 In the Question dialog box, click **Yes**.

Taking a service group offline in a remote cluster

This topic describes how to take a service group offline in a remote cluster.

To take a service group offline in a remote cluster

1 Do the following:

In the **Service Groups** tab of the Cluster Explorer configuration tree of a local cluster, right-click the service group.

or

Click a local cluster in the configuration tree, click the **Service Groups** tab, and right-click the service group icon in the view panel.

2 Click **Offline**, and click **Remote offline...**

3 In the Offline global group dialog box, do the following:

- Click the remote cluster to take the group offline.
- Click the specific system, or click **All Systems**, to take the group offline.
- Click **OK**.

4 In the Question dialog box, click **Yes**.

Switching a service group to a remote cluster

This topic describes how to switch a service group to a remote cluster.

To switch a service group to a remote cluster

1 Do the following:

In the **Service Groups** tab of the Cluster Explorer configuration tree of a local cluster, right-click the service group.

or

Click a local cluster in the configuration tree, click the **Service Groups** tab, and right-click the service group icon in the view panel.

2 Click **Switch To**, and click **Remote switch...**

3 In the Switch global group dialog box:

- Click the cluster to switch the group.
- Click the specific system, or click **Any System**, to switch the group. If you specify a system to switch the group and if the PreSwitch attribute value is set to 1, the VCS engine invokes the PreSwitch actions for the resources that support the action. If you want to skip these actions, you must temporarily set the PreSwitch attribute value to 0.

See “[Service group attributes](#)” on page 789.

4 In the Question dialog box, click **Yes**.

Administering global heartbeats

Use Cluster Explorer to add, modify, and delete heartbeats in a global cluster environment. Icmp heartbeats send Icmp packets simultaneously to all IP addresses; IcmpS heartbeats send individual Icmp packets to IP addresses in serial order. Global clustering requires a minimum of one heartbeat between clusters; the Icmp heartbeat is added when the cluster is added to the environment. You can add additional heartbeats as a precautionary measure.

Adding a global heartbeat

This topic describes how to add a global heartbeat.

To add a cluster heartbeat from Cluster Explorer

1 Click **Configure Heartbeats** on the **Edit** menu.

2 In the Heartbeat Configuration dialog box, do the following:

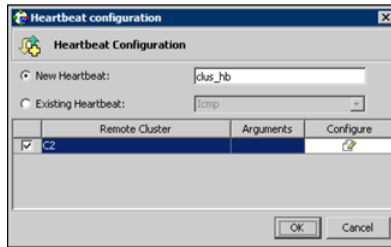

- Enter the name of the heartbeat.
- Select the check box next to the name of the cluster to add it to the cluster list for the heartbeat.
- Click the icon in the **Configure** column to open the Heartbeat Settings dialog box.
- Specify the value of the Arguments attribute and various timeout and interval fields. Click + to add an argument value; click - to delete it.
- Click **OK**.
- Click **OK** on the Heartbeat configuration dialog box.

To add a cluster heartbeat from Command Center

- 1 Click **Commands>Configuration>Cluster Objects>Add Heartbeat**.
- 2 Enter the name of the heartbeat.
- 3 Click **Apply**.

Modifying a global heartbeat

This topic describes how to modify a global heartbeat.

To modify a global heartbeat

- 1 From Cluster Explorer, click **Configure Heartbeats** on the **Edit** menu.
- 2 In the Heartbeat Configuration dialog box:

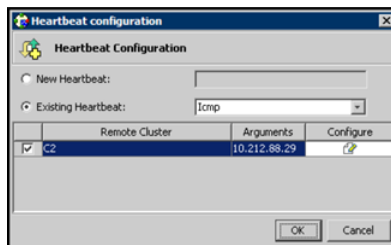

- Click **Existing Heartbeat**.
- Click the name of the existing heartbeat from the menu.
- Select or clear the check box next to the name of a cluster to add or remove it from the cluster list for the heartbeat.
- If necessary, click the icon in the **Configure** column to open the Heartbeat Settings dialog box. Otherwise, proceed to the last step.
- Change the values of the Arguments attribute and various timeout and interval fields. Click + to add an argument value; click - to delete it.

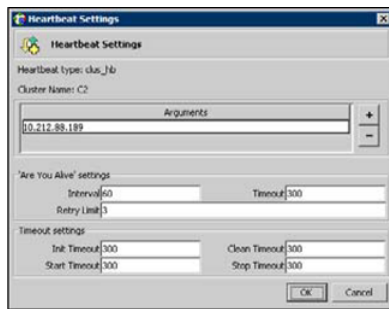

- Click **OK**.
- Click **OK** on the Heartbeat Configuration dialog box.

Deleting a global heartbeat

This topic describes how to delete a global heartbeat. You cannot delete the last heartbeat between global clusters.

To delete a cluster heartbeat from Command Center

- 1 Click **Commands>Configuration>Cluster Objects>Delete Heartbeat**.
- 2 Click the heartbeat to delete.
- 3 Click **Apply**.

Administering global clusters from the command line

This chapter includes the following topics:

- [About administering global clusters from the command line](#)
- [About global querying in a global cluster setup](#)
- [Administering global service groups in a global cluster setup](#)
- [Administering resources in a global cluster setup](#)
- [Administering clusters in global cluster setup](#)
- [Administering heartbeats in a global cluster setup](#)

About administering global clusters from the command line

For remote cluster operations, you must configure a VCS user with the same name and privileges in each cluster.

See [“User privileges for cross-cluster operations”](#) on page 85.

Review the following procedures to administer global clusters from the command-line.

See [“About global querying in a global cluster setup”](#) on page 615.

See [“Administering global service groups in a global cluster setup”](#) on page 622.

See “[Administering resources in a global cluster setup](#)” on page 624.

See “[Administering clusters in global cluster setup](#)” on page 624.

See “[Administering heartbeats in a global cluster setup](#)” on page 627.

About global querying in a global cluster setup

VCS enables you to query global cluster objects, including service groups, resources, systems, resource types, agents, and clusters. You may enter query commands from any system in the cluster. Commands to display information on the global cluster configuration or system states can be executed by all users; you do not need root privileges. Only global service groups may be queried.

See “[Querying global cluster service groups](#)” on page 615.

See “[Querying resources across clusters](#)” on page 616.

See “[Querying systems](#)” on page 618.

See “[Querying clusters](#)” on page 618.

See “[Querying status](#)” on page 620.

See “[Querying heartbeats](#)” on page 620.

Querying global cluster service groups

This topic describes how to perform a query on global cluster service groups:

To display service group attribute values across clusters

- ◆ Use the following command to display service group attribute values across clusters:

```
hagrp -value service_group attribute [system]  
[-clus cluster | -localclus]
```

The option `-clus` displays the attribute value on the cluster designated by the variable `cluster`; the option `-localclus` specifies the local cluster.

If the attribute has local scope, you must specify the system name, except when querying the attribute on the system from which you run the command.

To display the state of a service group across clusters

- ◆ Use the following command to display the state of a service group across clusters:

```
hagrp -state [service_groups -sys systems]  
[-clus cluster | -localclus]
```

The option `-clus` displays the state of all service groups on a cluster designated by the variable `cluster`; the option `-localclus` specifies the local cluster.

To display service group information across clusters

- ◆ Use the following command to display service group information across clusters:

```
hagrp -display [service_groups] [-attribute attributes]  
[-sys systems] [-clus cluster | -localclus]
```

The option `-clus` applies to global groups only. If the group is local, the cluster name must be the local cluster name, otherwise no information is displayed.

To display service groups in a cluster

- ◆ Use the following command to display service groups in a cluster:

```
hagrp -list [conditionals] [-clus cluster | -localclus]
```

The option `-clus` lists all service groups on the cluster designated by the variable `cluster`; the option `-localclus` specifies the local cluster.

To display usage for the service group command

- ◆ Use the following command to display usage for the service group command:

```
hagrp [-help [-modify|-link|-list]]
```

Querying resources across clusters

This topic describes how to perform queries on resources:

To display resource attribute values across clusters

- ◆ Use the following command to display resource attribute values across clusters:

```
hares -value resource attribute [system]  
[-clus cluster | -localclus]
```

The option `-clus` displays the attribute value on the cluster designated by the variable `cluster`; the option `-localclus` specifies the local cluster.

If the attribute has local scope, you must specify the system name, except when querying the attribute on the system from which you run the command.

To display the state of a resource across clusters

- ◆ Use the following command to display the state of a resource across clusters:

```
hares -state [resource -sys system]  
[-clus cluster | -localclus]
```

The option `-clus` displays the state of all resources on the specified cluster; the option `-localclus` specifies the local cluster. Specifying a system displays resource state on a particular system.

To display resource information across clusters

- ◆ Use the following command to display resource information across clusters:

```
hares -display [resources] [-attribute attributes]  
[-group service_groups] [-type types] [-sys systems]  
[-clus cluster | -localclus]
```

The option `-clus` lists all service groups on the cluster designated by the variable `cluster`; the option `-localclus` specifies the local cluster.

To display a list of resources across clusters

- ◆ Use the following command to display a list of resources across clusters:

```
hares -list [conditionals] [-clus cluster | -localclus]
```

The option `-clus` lists all resources that meet the specified conditions in global service groups on a cluster as designated by the variable `cluster`.

To display usage for the resource command

- ◆ Use the following command to display usage for the resource command:

```
hares -help [-modify | -list]
```

Querying systems

This topic describes how to perform queries on systems:

To display system attribute values across clusters

- ◆ Use the following command to display system attribute values across clusters:

```
hasys -value system attribute [-clus cluster | -localclus]
```

The option `-clus` displays the values of a system attribute in the cluster as designated by the variable `cluster`; the option `-localclus` specifies the local cluster.

To display the state of a system across clusters

- ◆ Use the following command to display the state of a system across clusters:

```
hasys -state [system] [-clus cluster | -localclus]
```

Displays the current state of the specified system. The option `-clus` displays the state in a cluster designated by the variable `cluster`; the option `-localclus` specifies the local cluster. If you do not specify a system, the command displays the states of all systems.

For information about each system across clusters

- ◆ Use the following command to display information about each system across clusters:

```
hasys -display [systems] [-attribute attributes] [-clus cluster | -localclus]
```

The option `-clus` displays the attribute values on systems (if specified) in a cluster designated by the variable `cluster`; the option `-localclus` specifies the local cluster.

For a list of systems across clusters

- ◆ Use the following command to display a list of systems across clusters:

```
hasys -list [conditionals] [-clus cluster | -localclus]
```

Displays a list of systems whose values match the given conditional statements. The option `-clus` displays the systems in a cluster designated by the variable `cluster`; the option `-localclus` specifies the local cluster.

Querying clusters

This topic describes how to perform queries on clusters:

For the value of a specific cluster attribute on a specific cluster

- ◆ Use the following command to obtain the value of a specific cluster attribute on a specific cluster:

```
haclus -value attribute [cluster] [-localclus]
```

The attribute must be specified in this command. If you do not specify the cluster name, the command displays the attribute value on the local cluster.

To display the state of a local or remote cluster

- ◆ Use the following command to display the state of a local or remote cluster:

```
haclus -state [cluster] [-localclus]
```

The variable *cluster* represents the cluster. If a cluster is not specified, the state of the local cluster and the state of all remote cluster objects as seen by the local cluster are displayed.

For information on the state of a local or remote cluster

- ◆ Use the following command for information on the state of a local or remote cluster:

```
haclus -display [cluster] [-localclus]
```

If a cluster is not specified, information on the local cluster is displayed.

For a list of local and remote clusters

- ◆ Use the following command for a list of local and remote clusters:

```
haclus -list [conditionals]
```

Lists the clusters that meet the specified conditions, beginning with the local cluster.

To display usage for the cluster command

- ◆ Use the following command to display usage for the cluster command:

```
haclus [-help [-modify]]
```

To display the status of a faulted cluster

- ◆ Use the following command to display the status of a faulted cluster:

```
haclus -status cluster
```

Displays the status on the specified faulted cluster. If no cluster is specified, the command displays the status on all faulted clusters. It lists the service groups that were not in the OFFLINE or the FAULTED state before the fault occurred. It also suggests corrective action for the listed clusters and service groups.

Querying status

This topic describes how to perform queries on status of remote and local clusters:

For the status of local and remote clusters

- ◆ Use the following command to obtain the status of local and remote clusters:

```
hastatus
```

Querying heartbeats

The hahb command is used to manage WAN heartbeats that emanate from the local cluster. Administrators can monitor the "health of the remote cluster via heartbeat commands and mechanisms such as Internet, satellites, or storage replication technologies. Heartbeat commands are applicable only on the cluster from which they are issued.

Note: You must have Cluster Administrator privileges to add, delete, and modify heartbeats.

The following commands are issued from the command line.

For a list of heartbeats configured on the local cluster

- ◆ Use the following command for a list of heartbeats configured on the local cluster:

```
hahb -list [conditionals]
```

The variable *conditionals* represents the conditions that must be met for the heartbeat to be listed.

To display information on heartbeats configured in the local cluster

- ◆ Use the following command to display information on heartbeats configured in the local cluster:

```
hahb -display [heartbeat ...]
```

If *heartbeat* is not specified, information regarding all heartbeats configured on the local cluster is displayed.

To display the state of the heartbeats in remote clusters

- ◆ Use the following command to display the state of heartbeats in remote clusters:

```
hahb -state [heartbeat] [-clus cluster]
```

For example, to get the state of heartbeat *lcmp* from the local cluster to the remote cluster *phoenix*:

```
hahb -state lcmp -clus phoenix
```

To display an attribute value of a configured heartbeat

- ◆ Use the following command to display an attribute value of a configured heartbeat:

```
hahb -value heartbeat attribute [-clus cluster]
```

The `-value` option provides the value of a single attribute for a specific heartbeat. The cluster name must be specified for cluster-specific attribute values, but not for global.

For example, to display the value of the `ClusterList` attribute for heartbeat *lcmp*:

```
hahb -value lcmp ClusterList
```

Note that `ClusterList` is a global attribute.

To display usage for the command `hahb`

- ◆ Use the following command to display usage for the command `hahb`:

```
hahb [-help [-modify]]
```

If the `-modify` option is specified, the usage for the `hahb -modify` option is displayed.

Administering global service groups in a global cluster setup

Operations for the VCS global clusters option are enabled or restricted depending on the permissions with which you log on. The privileges associated with each user role are enforced for cross-cluster, service group operations.

This topic includes commands to administer global service groups.

See the `hagrp` (1M) manual page for more information.

To administer global service groups in a global cluster setup

- ◆ Depending on the administrative task you want to perform on global service groups, run the `hagrp` command as follows:

To bring a service group online across clusters for the first time

```
hagrp -online -force
```

To bring a service group online across clusters

```
hagrp -online service_group -sys system [-clus cluster | -localclus]
```

The option `-clus` brings the service group online on the system designated in the cluster. If a system is not specified, the service group is brought online on any node within the cluster. The option `-localclus` brings the service group online in the local cluster.

To bring a service group online on any node

```
hagrp -online [-force] service_group -any [-clus cluster | -localclus]
```

The option `-any` specifies that HAD brings a failover group online on the optimal system, based on the requirements of service group workload management and existing group dependencies. If bringing a parallel group online, HAD brings the group online on each system designated in the `SystemList` attribute.

To display the resources for a service group

```
hagrp -resources service_group [-clus cluster_name | -localclus]
```

The option `-clus` displays information for the cluster designated by the variable `cluster_name`; the option `-localclus` specifies the local cluster.

To take a service group offline across clusters

```
hagrp -offline [-force] [-ifprobed] service_group -sys system [-clus cluster | -localclus]
```

The option `-clus` takes offline the service group on the system designated in the cluster.

To take a service group offline anywhere

```
hagrp -offline [-ifprobed] service_group -any [-clus cluster | -localclus]
```

The option `-any` specifies that HAD takes a failover group offline on the system on which it is online. For a parallel group, HAD takes the group offline on each system on which the group is online. HAD adheres to the existing group dependencies when taking groups offline.

To switch a service group across clusters

```
hagrp -switch service_group -to system [-clus cluster | -localclus [-nopre]]
```

The option `-clus` identifies the cluster to which the service group will be switched. The service group is brought online on the system specified by the `-to system` argument. If a system is not specified, the service group may be switched to any node within the specified cluster.

The option `-nopre` indicates that the VCS engine must switch the service group regardless of the value of the PreSwitch service group attribute.

To switch a service group anywhere

```
hagrp -switch service_group -any [-clus cluster | -localclus]
```

The `-any` option specifies that the VCS engine switches a service group to the best possible system on which it is currently not online, based on the value of the group's FailOverPolicy attribute. The VCS engine switches a global service group from a system to another system in the local cluster or a remote cluster.

If you do not specify the `-clus` option, the VCS engine by default assumes `-localclus` option and selects an available system within the local cluster.

The option `-clus` identifies the remote cluster to which the service group will be switched. The VCS engine then selects the target system on which to switch the service group.

To switch a parallel global service group across clusters

```
hagrp -switch
```

VCS brings the parallel service group online on all possible nodes in the remote cluster.

Administering resources in a global cluster setup

This topic describes how to administer resources.

See the `hares` (1M) manual page for more information.

To administer resources in a global cluster setup

- ◆ Depending on the administrative task you want to perform for resources, run the `hares` command as follows:

To take action on a resource across clusters

```
hares -action resource token [-actionargs arg1 ...] [-sys system] [-clus cluster | -localclus]
```

The option `-clus` implies resources on the cluster. If the designated system is not part of the local cluster, an error is displayed. If the `-sys` option is not used, it implies resources on the local node.

To invoke the Info function across clusters

```
hares -refreshinfo resource [-sys system] [-clus cluster | -localclus]
```

Causes the Info function to update the value of the ResourceInfo resource level attribute for the specified resource if the resource is online. If no system or remote cluster is specified, the Info function runs on local system(s) where the resource is online.

To display usage for the resource command

```
hares [-help [-modify | -list]]
```

Administering clusters in global cluster setup

The topic includes commands that are used to administer clusters in a global cluster setup.

See the `haclus` (1M) manual page for more information.

To administer clusters in global cluster setup

- ◆ Depending on the administrative task you want to perform on the clusters, run the `haclus` command as follows:

The variable `cluster` in the following commands represents the cluster.

To add a remote cluster object

```
haclus -add cluster ip
```

This command does not apply to the local cluster.

To delete a remote cluster object	<code>haclus -delete cluster</code>
To modify an attribute of a local or remote cluster object	<code>haclus -modify attribute value [-clus cluster]...</code>
To declare the state of a cluster after a disaster	<code>haclus -declare disconnnet/outage/disaster/replica -clus cluster [-failover]</code>
To manage cluster alerts	See “Managing cluster alerts in a global cluster setup” on page 625.
To change the cluster name	See “Changing the cluster name in a global cluster setup” on page 626.

Managing cluster alerts in a global cluster setup

This topic includes commands to manage cluster alerts.

See the `haalert` (1M) manual page for more information.

To manage cluster alerts

- ◆ Run the `haalert` command to manage cluster alerts.

`haalert -testfd` Generates a simulated "cluster fault" alert that is sent to the VCS engine and GUI.

`haalert -display` For each alert, the command displays the following information:

- alert ID
- time when alert occurred
- cluster on which alert occurred
- object name for which alert occurred
- (cluster name, group name, and so on).
- informative message about alert

`haalert -list` For each alert, the command displays the following information:

- time when alert occurred
- alert ID

<pre>haalert -delete alert_id -notes "description"</pre>	Deletes a specific alert. You must enter a text message within quotes describing the reason for deleting the alert. The comment is written to the engine log as well as sent to any connected GUI clients.
<pre>haalert -help</pre>	Displays the usage text

Changing the cluster name in a global cluster setup

This topic describes how to change the ClusterName attribute in a global cluster configuration. The instructions describe how to rename VCSPriCluster to VCSPriCluster2 in a two-cluster configuration, comprising clusters VCSPriCluster and VCSecCluster configured with the global group AppGroup.

Before changing the cluster name, make sure the cluster is not part of any ClusterList, in the wide-area Heartbeat agent and in global service groups.

To change the name of a cluster

- 1 Run the following commands from cluster VCSPriCluster:

```
hagrp -offline ClusterService -any  
hagrp -modify AppGroup ClusterList -delete VCSPriCluster  
haclus -modify ClusterName VCSPriCluster2  
hagrp -modify AppGroup ClusterList -add VCSPriCluster2 0
```

- 2 Run the following commands from cluster VCSecCluster:

```
hagrp -offline ClusterService -any  
hagrp -modify appgrp ClusterList -delete VCSPriCluster  
hahb -modify Icmp ClusterList -delete VCSPriCluster  
haclus -delete VCSPriCluster  
haclus -add VCSPriCluster2 your_ip_address  
hahb -modify Icmp ClusterList -add VCSPriCluster2  
hahb -modify Icmp Arguments your_ip_address -clus VCSPriCluster2  
hagrp -modify AppGroup ClusterList -add VCSPriCluster2 0  
hagrp -online ClusterService -any
```

- 3 Run the following command from the cluster renamed to VCSPriCluster2:

```
hagrp -online ClusterService -any
```

Removing a remote cluster from a global cluster setup

This topic includes commands that are used to remove the remote cluster from the cluster list.

To remove a remote cluster in a global cluster setup

- 1 Run the following command:

```
hagrp -offline ClusterService -any
```

- 2 Remove the remote cluster from the ClusterList of all the global groups using the following command:

```
hagrp -modify <global_group> ClusterList -delete <remote_clus>
```

- 3 Remove the remote cluster from the ClusterList of all the heartbeats using the following command:

```
hahb -modify Icmp ClusterList -delete <remote_clus>
```

- 4 Delete the remote cluster using the following command:

```
haclus -delete <remote_clus>
```

Administering heartbeats in a global cluster setup

This topic includes commands that are used to administer heartbeats.

See the `hahb` (1M) manual page for more information.

To administer heartbeats in a global cluster setup

- ◆ Depending on the administrative task you want to perform for heartbeats, run the `hahb` command as follows:

To create a heartbeat

```
hahb -add heartbeat
```

For example, type the following command to add a new `IcmpS` heartbeat. This represents a heartbeat sent from the local cluster and immediately forks off the specified agent process on the local cluster.

```
hahb -add IcmpS
```

To modify a heartbeat

```
hahb -modify heartbeat attribute value ... [-clus cluster]
```

If the attribute is local, that is, it has a separate value for each remote cluster in the ClusterList attribute, the option `-clus cluster` must be specified. Use `-delete -keys` to clear the value of any list attributes.

For example, type the following command to modify the ClusterList attribute and specify targets "phoenix and "houston for the newly created heartbeat:

```
hahb -modify Icmp ClusterList phoenix houston
```

To modify the Arguments attribute for target phoenix:

```
hahb -modify Icmp Arguments phoenix.example.com  
-clus phoenix
```

To delete a heartbeat

```
hahb -delete heartbeat
```

To change the scope of an attribute to cluster-specific

```
hahb -local heartbeat attribute
```

For example, type the following command to change the scope of the attribute AYAIInterval from global to cluster-specific:

```
hahb -local Icmp AYAIInterval
```

To change the scope of an attribute to global

```
hahb -global heartbeat attribute value ... | key  
... | key value ...
```

For example, type the following command to change the scope of the attribute AYAIInterval from cluster-specific to cluster-generic:

```
hahb -global Icmp AYAIInterval 60
```

Setting up replicated data clusters

This chapter includes the following topics:

- [About replicated data clusters](#)
- [How VCS replicated data clusters work](#)
- [About setting up a replicated data cluster configuration](#)
- [About migrating a service group](#)
- [About setting up a fire drill](#)

About replicated data clusters

The Replicated Data Cluster (RDC) configuration provides both local high availability and disaster recovery functionality in a single VCS cluster.

You can set up RDC in a VCS environment using Volume Replicator (VVR).

A Replicated Data Cluster (RDC) uses data replication to assure data access to nodes. An RDC exists within a single VCS cluster. In an RDC configuration, if an application or a system fails, the application is failed over to another system within the current primary site. If the entire primary site fails, the application is migrated to a system in the remote secondary site (which then becomes the new primary).

For VVR replication to occur, the disk groups containing the Replicated Volume Group (RVG) must be imported at the primary and secondary sites. The replication service group must be online at both sites simultaneously, and must be configured as a hybrid VCS service group.

The application service group is configured as a failover service group. The application service group must be configured with an *online local hard* dependency on the replication service group.

Note: VVR supports multiple replication secondary targets for any given primary. However, RDC for VCS supports only one replication secondary for a primary.

An RDC configuration is appropriate in situations where dual dedicated LLT links are available between the primary site and the disaster recovery secondary site but lacks shared storage or SAN interconnect between the primary and secondary data centers. In an RDC, data replication technology is employed to provide node access to data in a remote site.

Note: You must use dual dedicated LLT links between the replicated nodes.

How VCS replicated data clusters work

To understand how a replicated data cluster configuration works, let us take the example of an application configured in a VCS replicated data cluster. The configuration has two system zones:

- Primary zone (zone 0) comprising nodes located at the primary site and attached to the primary storage
- Secondary zone (zone 1) comprising nodes located at the secondary site and attached to the secondary storage

The application is installed and configured on all nodes in the cluster. Application data is located on shared disks within each RDC site and is replicated across RDC site to ensure data concurrency. The application service group is online on a system in the current primary zone and is configured to fail over in the cluster.

Figure 21-1 depicts an application configured on a VCS replicated data cluster.

Figure 21-1 A VCS replicated data cluster configuration

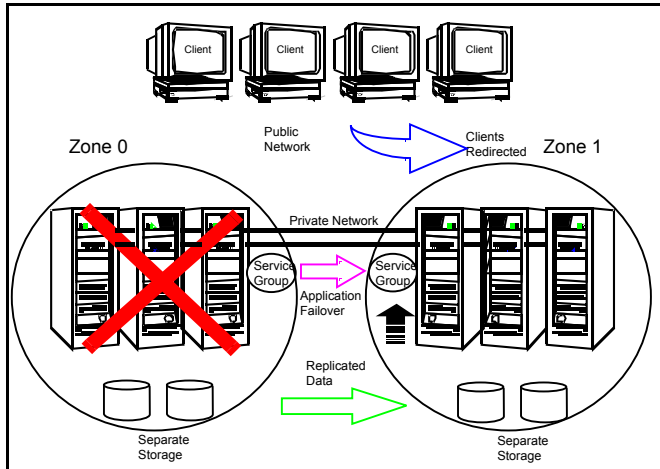

In the event of a system or application failure, VCS attempts to fail over the application service group to another system within the same RDC site. However, in the event that VCS fails to find a failover target node within the primary RDC site, VCS switches the service group to a node in the current secondary RDC site (zone 1).

About setting up a replicated data cluster configuration

This topic describes the steps for planning, configuring, testing, and using the VCS RDC configuration to provide a robust and easy-to-manage disaster recovery protection for your applications. It describes an example of converting a single instance Oracle database configured for local high availability in a VCS cluster to a disaster-protected RDC infrastructure. The solution uses Volume Replicator to replicate changed data.

About typical replicated data cluster configuration

Figure 21-2 depicts a dependency chart of a typical RDC configuration.

Figure 21-2 Dependency chart of a typical RDC configuration

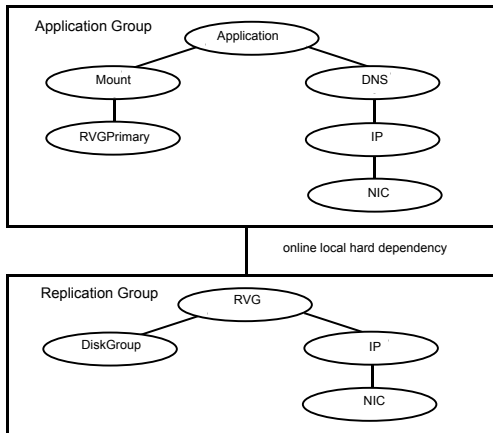

In this example, a single-instance application is configured as a VCS service group (DiskGroup) on a four-node cluster, with two nodes in the primary RDC system zone and two in the secondary RDC system zone. In the event of a failure on the primary node, VCS fails over the application to the second node in the primary zone.

The process involves the following steps:

- Setting Up Replication
- Configuring the Service Groups
- Configuring the Service Group Dependencies

About setting up replication

Veritas Volume Replicator (VVR) technology is a license-enabled feature of Veritas Volume Manager (VxVM), so you can convert VxVM-managed volumes into replicated volumes managed using VVR. In this example, the process involves grouping the Oracle data volumes into a Replicated Volume Group (RVG), and creating the VVR Secondary on hosts in another VCS cluster, located in your DR site.

When setting up VVR, it is a best practice to use the same DiskGroup and RVG name on both sites. If the volume names are the same on both zones, the Mount resources will mount the same block devices, and the same Oracle instance will start on the secondary in case of a failover.

Configuring the service groups

This topic describes how to configure service groups.

To configure the replication group

- 1 Create a hybrid service group (oragrp_rep) for replication.
See [“Types of service groups”](#) on page 36.
- 2 Copy the DiskGroup resource from the application to the new group. Configure the resource to point to the disk group that contains the RVG.
- 3 Configure new resources of type IP and NIC.
- 4 Configure a new resource of type RVG in the service group.
- 5 Set resource dependencies as per the following information:
 - RVG resource depends on the IP resource
 - RVG resource depends on the DiskGroup resource
 - IP resource depends on the NIC resource
- 6 Set the SystemZones attribute of the child group, oragrp_rep, such that all nodes in the primary RDC zone are in system zone 0 and all nodes in the secondary RDC zone are in system zone 1.

To configure the application service group

- 1 In the original Oracle service group (oragroup), delete the DiskGroup resource.
- 2 Add an RVGPrimary resource and configure its attributes.
Set the value of the RvgResourceName attribute to the name of the RVG type resource that will be promoted and demoted by the RVGPrimary agent.
Set the AutoTakeover and AutoResync attributes from their defaults as desired.
- 3 Set resource dependencies such that all Mount resources depend on the RVGPrimary resource. If there are a lot of Mount resources, you can set the TypeDependencies attribute for the group to denote that the Mount resource type depends on the RVGPrimary resource type.

- 4 Set the `SystemZones` attribute of the Oracle service group such that all nodes in the primary RDC zone are in system zone 0 and all nodes in the secondary RDC zone are in zone 1. The `SystemZones` attribute of both the parent and the child group must be identical.
- 5 If your setup uses BIND DNS, add a resource of type DNS to the oragroup service group. Set the `Hostname` attribute to the canonical name of the host or virtual IP address that the application uses on that cluster. This ensures DNS updates to the site when the group is brought online. A DNS resource would be necessary only if the nodes in the primary and the secondary RDC zones are in different IP subnets.

Configuring the service group dependencies

Set an online local hard group dependency from application service group to the replication service group to ensure that the service groups fail over and switch together.

- 1 In the Cluster Explorer configuration tree, select the cluster name.
- 2 In the view panel, click the **Service Groups** tab. This opens the service group dependency graph.
- 3 Click **Link**.
- 4 Click the parent group oragroup and move the mouse toward the child group, oragroup_rep.
- 5 Click the child group oragroup_rep.
- 6 On the Link Service Groups dialog box, click the online local relationship and the hard dependency type and click **OK**.

About migrating a service group

In the RDC set up for the Oracle database, consider a case where the primary RDC zone suffers a total failure of the shared storage. In this situation, none of the nodes in the primary zone see any device.

The Oracle service group cannot fail over locally within the primary RDC zone, because the shared volumes cannot be mounted on any node. So, the service group must fail over, to a node in the current secondary RDC zone.

The RVGPrimary agent ensures that VVR volumes are made writable and the DNS agent ensures that name services are resolved to the DR site. The application can be started at the DR site and run there until the problem with the local storage is corrected.

If the storage problem is corrected, you can switch the application to the primary site using VCS.

Switching the service group

Before switching the application back to the original primary RDC zone, you must resynchronize any changed data from the active DR site since the failover. This can be done manually through VVR or by running a VCS action from the RVGPrimary resource.

To switch the service group

- 1 In the **Service Groups** tab of the configuration tree, right-click the resource.
- 2 Click **Actions**.
- 3 Specify the details of the action as follows:
 - From the **Action** list, choose **fbsync**.
 - Click the system on which to execute the action.
 - Click **OK**.

This begins a fast-failback of the replicated data set. You can monitor the value of the ResourceInfo attribute for the RVG resource to determine when the resynchronization has completed.

- 4 Once the resynchronization completes, switch the service group to the primary cluster. In the **Service Groups** tab of the of the Cluster Explorer configuration tree, right-click the service group.
- 5 Click **Switch To** and select the system in the primary RDC zone to switch to and click OK.

About setting up a fire drill

You can use fire drills to test the configuration's fault readiness by mimicking a failover without stopping the application in the primary data center.

See [“About setting up a disaster recovery fire drill”](#) on page 584.

Setting up campus clusters

This chapter includes the following topics:

- [About campus cluster configuration](#)
- [VCS campus cluster requirements](#)
- [Typical VCS campus cluster setup](#)
- [How VCS campus clusters work](#)
- [About setting up a campus cluster configuration](#)
- [Fire drill in campus clusters](#)
- [About the DiskGroupSnap agent](#)
- [About running a fire drill in a campus cluster](#)

About campus cluster configuration

The campus cluster configuration provides local high availability and disaster recovery functionality in a single VCS cluster. This configuration uses data mirroring to duplicate data at different sites. There is no Host or Array base replication involved.

VCS supports campus clusters that employ disk groups mirrored with Veritas Volume Manager.

VCS campus cluster requirements

Review the following requirements for VCS campus clusters:

- You must install VCS.
- You must have a single VCS cluster with at least one node in each of the two sites, where the sites are separated by a physical distance of no more than 80 kilometers. When the sites are separated more than 80 kilometers, you can run Global Cluster Option (GCO) configuration.
- You must have redundant network connections between nodes. All paths to storage must also be redundant.

Veritas recommends the following in a campus cluster setup:

- A common cross-site physical infrastructure for storage and LLT private networks.
Veritas recommends a common cross-site physical infrastructure for storage and LLT private networks
- Technologies such as Dense Wavelength Division Multiplexing (DWDM) for network and I/O traffic across sites. Use redundant links to minimize the impact of network failure.
- You must install Veritas Volume Manager with the FMR license and the Site Awareness license.
- Veritas recommends that you configure I/O fencing to prevent data corruption in the event of link failures.
See the Cluster Server Configuration and Upgrade Guide for more details.
- You must configure storage to meet site-based allocation and site-consistency requirements for VxVM.
 - All the nodes in the site must be tagged with the appropriate VxVM site names.
 - All the disks must be tagged with the appropriate VxVM site names.
 - The VxVM site names of both the sites in the campus cluster must be added to the disk groups.
 - The `allsites` attribute for each volume in the disk group must be set to on. (By default, the value is set to on.)
 - The `siteconsistent` attribute for the disk groups must be set to on.

Typical VCS campus cluster setup

Figure 22-1 depicts a typical VCS campus cluster setup.

Figure 22-1 Typical VCS campus cluster setup

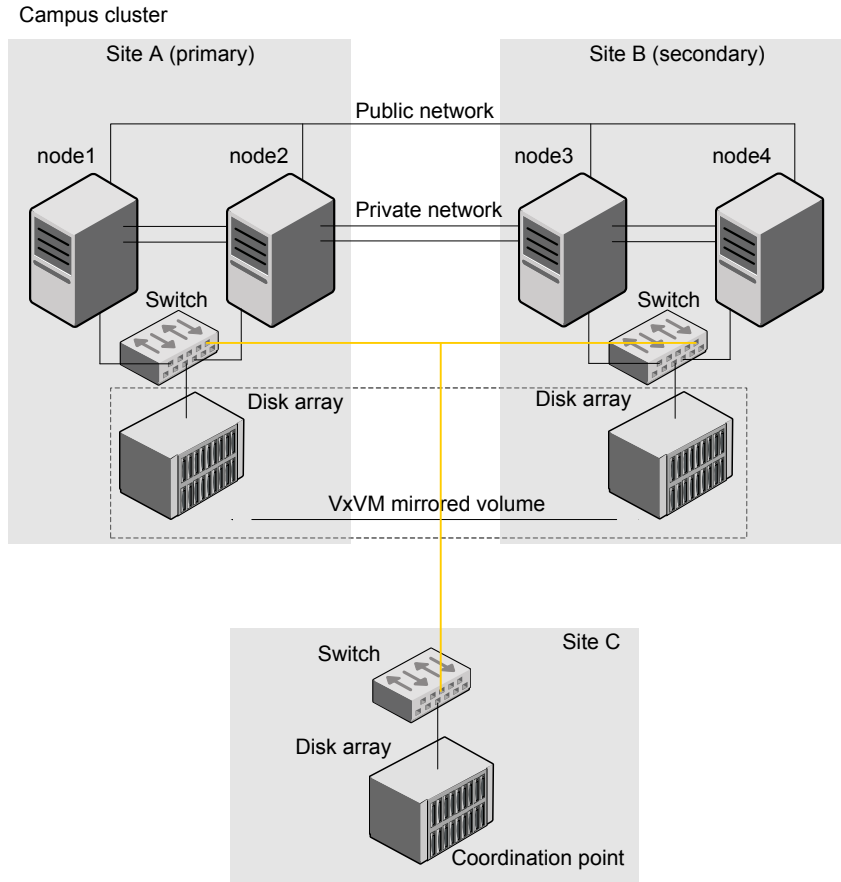

VCS campus cluster typically has the following characteristics:

- Single VCS cluster spans multiple sites.
 In the sample figure, VCS is configured on four nodes: node 1 and node 2 are located at site A and node 3 and node 4 at site B.
- I/O fencing is configured with one coordinator disk from each site of the campus cluster and another coordinator disk from a third site.
 Figure 22-1 illustrates a typical setup with disk-based I/O fencing. You can also configure server-based I/O fencing.

See [“About I/O fencing in campus clusters”](#) on page 643.

- The shared data is located on mirrored volumes on a disk group configured using Veritas Volume Manager.
- The volumes that are required for the application have mirrors on both the sites.
- All nodes in the cluster are tagged with the VxVM site name. All disks that belong to a site are tagged with the corresponding VxVM site name.
- The disk group is configured in VCS as a resource of type DiskGroup and is mounted using the Mount resource type.

How VCS campus clusters work

This topic describes how VCS works with VxVM to provide high availability in a campus cluster environment.

In a campus cluster setup, VxVM automatically mirrors volumes across sites. To enhance read performance, VxVM reads from the plexes at the local site where the application is running. VxVM writes to plexes at both the sites.

In the event of a storage failure at a site, VxVM detaches all the disks at the failed site from the disk group to maintain data consistency. When the failed storage comes back online, VxVM automatically reattaches the site to the disk group and recovers the plexes.

See the *Storage Foundation Cluster File System High Availability Administrator's Guide* for more information.

When service group or system faults occur, VCS fails over service groups based on the values you set for the cluster attribute SiteAware and the service group attribute AutoFailOver.

See [“Service group attributes”](#) on page 789.

See [“Cluster attributes”](#) on page 831.

For campus cluster setup, you must define sites and add systems to the sites that you defined. A system can belong to only one site. Site definitions are uniform across VCS, Veritas InfoScale Operations Manager, and VxVM. You can define site dependencies to restrict connected applications to fail over within the same site.

You can define sites by using:

- Veritas InfoScale Operations Manager
For more information on configuring sites, see the latest version of the *Veritas InfoScale Operations Manager User guide*.

Depending on the value of the `AutoFailOver` attribute, VCS failover behavior is as follows:

- 0 VCS does not fail over the service group.
- 1 VCS fails over the service group to another suitable node.
By default, the `AutoFailOver` attribute value is set to 1.
- 2 VCS fails over the service group if another suitable node exists in the same site. Otherwise, VCS waits for administrator intervention to initiate the service group failover to a suitable node in the other site.
This configuration requires the HA/DR license enabled.
Veritas recommends that you set the value of `AutoFailOver` attribute to 2.

Sample definition for these service group attributes in the VCS `main.cf` is as follows:

```
cluster VCS_CLUS (  
    PreferredFencingPolicy = Site  
    SiteAware = 1  
)  
site MTV (  
    SystemList = { sys1, sys2 }  
)  
site SFO (  
    Preference = 2  
    SystemList = { sys3, sys4 }  
)
```

The sample configuration for `hybrid_group` with `AutoFailover = 1` and `failover_group` with `AutoFailover = 2` is as following:

```
hybrid_group (  
    Parallel = 2  
    SystemList = { sys1 = 0, sys2 = 1, sys3 = 2, sys4 = 3 }  
)  
  
failover_group (  
    AutoFailover = 2  
    SystemList = { sys1 = 0, sys2 = 1, sys3 = 2, sys4 = 3 }  
)
```

[Table 22-1](#) lists the possible failure scenarios and how VCS campus cluster recovers from these failures.

Table 22-1 Failure scenarios in campus cluster

Failure	Description and recovery
Node failure	<ul style="list-style-type: none"> ■ A node in a site fails. If the value of the AutoFailOver attribute is set to 1, VCS fails over the service group to another system within the same site defined for cluster or SystemZone defined by SystemZones attribute for the service group or defined by Veritas InfoScale Operations Manager. ■ All nodes in a site fail. If the value of the AutoFailOver attribute is set to 0, VCS requires administrator intervention to initiate a fail over in both the cases of node failure.
Application failure	The behavior is similar to the node failure.
Storage failure - one or more disks at a site fails	<p>VCS does not fail over the service group when such a storage failure occurs.</p> <p>VxVM detaches the site from the disk group if any volume in that disk group does not have at least one valid plex at the site where the disks failed.</p> <p>VxVM does not detach the site from the disk group in the following cases:</p> <ul style="list-style-type: none"> ■ None of the plexes are configured on the failed disks. ■ Some of the plexes are configured on the failed disks, and at least one plex for a volume survives at each site. <p>If only some of the disks that failed come online and if the vxrelocd daemon is running, VxVM relocates the remaining failed disks to any available disks. Then, VxVM automatically reattaches the site to the disk group and resynchronizes the plexes to recover the volumes.</p> <p>If all the disks that failed come online, VxVM automatically reattaches the site to the disk group and resynchronizes the plexes to recover the volumes.</p>
Storage failure - all disks at both sites fail	<p>VCS acts based on the DiskGroup agent's PanicSystemOnDGLoss attribute value.</p> <p>See the <i>Cluster Server Bundled Agents Reference Guide</i> for more information.</p>

Table 22-1 Failure scenarios in campus cluster (*continued*)

Failure	Description and recovery
Site failure	<p>All nodes and storage at a site fail.</p> <p>Depending on the value of the AutoFailOver attribute, VCS fails over the service group as follows:</p> <ul style="list-style-type: none"> ■ If the value is set to 1, VCS fails over the service group to a system. ■ If the value is set to 2, VCS requires administrator intervention to initiate the service group failover to a system in the other site. <p>Because the storage at the failed site is inaccessible, VCS imports the disk group in the application service group with all devices at the failed site marked as NODEVICE.</p> <p>When the storage at the failed site comes online, VxVM automatically reattaches the site to the disk group and resynchronizes the plexes to recover the volumes.</p>
Network failure (LLT interconnect failure)	<p>Nodes at each site lose connectivity to the nodes at the other site</p> <p>The failure of all private interconnects between the nodes can result in split brain scenario and cause data corruption.</p> <p>Review the details on other possible causes of split brain and how I/O fencing protects shared data from corruption.</p> <p>See "About data protection" on page 337.</p> <p>Veritas recommends that you configure I/O fencing to prevent data corruption in campus clusters.</p> <p>When the cluster attribute PreferredFencingPolicy is set as Site, the fencing driver gives preference to the node with higher site priority during the race for coordination points. VCS uses the site-level attribute Preference to determine the node weight.</p> <p>See "About I/O fencing in campus clusters" on page 643.</p>

Table 22-1 Failure scenarios in campus cluster (*continued*)

Failure	Description and recovery
<p>Network failure (LLT and storage interconnect failure)</p>	<p>Nodes at each site lose connectivity to the storage and the nodes at the other site</p> <p>Veritas recommends that you configure I/O fencing to prevent split brain and serial split brain conditions.</p> <ul style="list-style-type: none"> ■ If I/O fencing is configured: <p>The site that do not win the race triggers a system panic. See “About I/O fencing in campus clusters” on page 643. When you restore the network connectivity, VxVM detects the storage at the failed site, reattaches the site to the disk group, and resynchronizes the plexes to recover the volumes.</p> ■ If I/O fencing is not configured: <p>If the application service group was online at site A during such failure, the application service group remains online at the same site. Because the storage is inaccessible, VxVM detaches the disks at the failed site from the disk group. At site B where the application service group is offline, VCS brings the application service group online and imports the disk group with all devices at site A marked as NODEVICE. So, the application service group is online at both the sites and each site uses the local storage. This causes inconsistent data copies and leads to a site-wide split brain. When you restore the network connectivity between sites, a serial split brain may exist. See the <i>Storage Foundation Administrator’s Guide</i> for details to recover from a serial split brain condition.</p>

About I/O fencing in campus clusters

You must configure I/O fencing to prevent corruption of shared data in the event of a network partition.

See [“About membership arbitration”](#) on page 317.

See [“About data protection”](#) on page 337.

You can use coordinator disks, coordination point server (CP server), or a mix of both as coordination points to configure I/O fencing.

In a campus cluster setup, you can configure I/O fencing as follows:

- Two coordinator disks at one site and one coordinator disk at the other site

In this case, the site that has two coordinator disks has a higher probability to win the race. The disadvantage with this configuration is that if the site that has two coordinator disks encounters a site failure, then the other site also commits

suicide. With this configuration, I/O fencing cannot distinguish between an inaccessible disk and a failed preempt operation.

- One coordinator disk in each of the two sites and a third coordinator disk at a third site
This configuration ensures that fencing works even if one of the sites becomes unavailable. A coordinator disk in a third site allows at least a sub-cluster to continue operations in the event of a site failure in a campus cluster. The site that can access the coordinator disk in the third site in addition to its local coordinator disk wins the race. However, if both the sites of the campus cluster are unable to access the disk at the third site, each site gains one vote and the nodes at both the sites commit suicide.

You can also configure a coordination point server (CP server) at the third site instead of a third coordinator disk.

See the *Cluster Server Installation Guide* for more details to configure I/O fencing.

About setting up a campus cluster configuration

You must perform the following tasks to set up a campus cluster:

- [Preparing to set up a campus cluster configuration](#)
- [Configuring I/O fencing to prevent data corruption](#)
- [Configuring VxVM disk groups for campus cluster configuration](#)
- [Configuring VCS service group for campus clusters](#)

Preparing to set up a campus cluster configuration

Before you set up the configuration, review the VCS campus cluster requirements.

See “[VCS campus cluster requirements](#)” on page 637.

To prepare to set up a campus cluster configuration

- 1 Set up the physical infrastructure.
 - Set up access to the local storage arrays and to remote storage arrays on each node.
 - Set up private heartbeat network.

See “[Typical VCS campus cluster setup](#)” on page 638.

- 2 Install VCS on each node to form a cluster with at least one node in each of the two sites.

See the *Cluster Server Configuration and Upgrade Guide* for instructions.

- 3 Install VxVM on each node with the required licenses.

See the *Storage Foundation and High Availability Configuration and Upgrade Guide* for instructions.

Configuring I/O fencing to prevent data corruption

Perform the following tasks to configure I/O fencing to prevent data corruption in the event of a communication failure.

See “[About I/O fencing in campus clusters](#)” on page 643.

See the *Cluster Server Configuration and Upgrade Guide* for more details.

To configure I/O fencing to prevent data corruption

- 1 Set up the storage at a third site.

You can extend the DWDM to the third site to have FC SAN connectivity to the storage at the third site. You can also use iSCSI targets as the coordinator disks at the third site.

- 2 Set up I/O fencing.

Configuring VxVM disk groups for campus cluster configuration

Follow the procedure to configure VxVM disk groups for remote mirroring.

See the *Storage Foundation Cluster File System High Availability Administrator's Guide* for more information on the VxVM commands.

Note: You can also configure VxVM disk groups for remote mirroring using Veritas InfoScale Operations Manager.

To configure VxVM disk groups for campus cluster configuration

- 1 Set the site name for each host:

```
# vxctl set site=sitename
```

The site name is stored in the `/etc/vx/volboot` file. Use the following command to display the site names:

```
# vxctl list | grep siteid
```

- 2 Set the site name for all the disks in an enclosure:

```
# vxdisk settag site=sitename encl:enclosure
```

To tag specific disks, use the following command:

```
# vxdisk settag site=sitename disk
```

- 3 Verify that the disks are registered to a site.

```
# vxdisk listtag
```

- 4 Create a disk group with disks from both the sites.

```
# vxvg -s init diskgroup siteA_disk1 siteB_disk2
```

- 5 Configure site-based allocation on the disk group that you created for each site that is registered to the disk group.

```
# vxvg -g diskgroup addsite sitename
```

- 6 Configure site consistency on the disk group.

```
# vxvg -g diskgroup set siteconsistent=on
```

- 7 Create one or more mirrored volumes in the disk group.

```
# vxassist -g diskgroup make volume size nmirror=1/2
```

With the Site Awareness license installed on all hosts, the volume that you create has the following characteristics by default:

- The `allsites` attribute is set to `on`; the volumes have at least one plex at each site.

- The volumes are automatically mirrored across sites.
- The read policy `rdpol` is set to `siteread`.
- The volumes inherit the site consistency value that is set on the disk group.

Configuring VCS service group for campus clusters

Follow the procedure to configure the disk groups under VCS control and set up the VCS attributes to define failover in campus clusters.

To configure VCS service groups for campus clusters

- 1 Create a VCS service group (`app_sg`) for the application that runs in the campus cluster.

```
hagrp -add app_sg
hagrp -modify app_sg SystemList node1 0 node2 1 node3 2 node4 3
```

- 2 Set up the system zones or sites. Configure the `SystemZones` attribute for the service group. Skip this step when sites are configured through Veritas InfoScale Operations Manager.

```
hagrp -modify app_sg SystemZones node1 0 node2 0 node3 1 node4 1
```

- 3 Set up the group fail over policy. Set the value of the `AutoFailOver` attribute for the service group.

```
hagrp -modify app_sg AutoFailOver 2
```

- 4 For the disk group you created for campus clusters, add a `DiskGroup` resource to the VCS service group `app_sg`.

```
hares -add dg_res1 DiskGroup app_sg
hares -modify dg_res1 DiskGroup diskgroup_name
hares -modify dg_res1 Enabled 1
```

- 5 Configure the application and other related resources to the `app_sg` service group.
- 6 Bring the service group online.

Fire drill in campus clusters

Fire drill tests the disaster-readiness of a configuration by mimicking a failover without stopping the application and disrupting user access.

The process involves creating a fire drill service group, which is similar to the original application service group. Bringing the fire drill service group online on the remote node demonstrates the ability of the application service group to fail over and come online at the site, should the need arise.

Fire drill service groups do not interact with outside clients or with other instances of resources, so they can safely come online even when the application service group is online. Conduct a fire drill only at the remote site; do not bring the fire drill service group online on the node hosting the original application.

About the DiskGroupSnap agent

The DiskGroupSnap agent verifies the VxVM disk groups and volumes for site awareness and disaster readiness in a campus cluster environment. To perform a fire drill in campus clusters, you must configure a resource of type DiskGroupSnap in the fire drill service group.

Note: To perform fire drill, the application service group must be online at the primary site.

During fire drill, the DiskGroupSnap agent does the following:

- For each node in a site, the agent correlates the value of the SystemZones attribute for the application service group to the VxVM site names for that node.
- For the disk group in the application service group, the agent verifies that the VxVM site tags are defined for the disk group.
- For the disk group in the application service group, the agent verifies that the disks at the secondary site are not tagged with the same VxVM site name as the disks at the primary site.
- The agent verifies that all volumes in the disk group have a plex at each site.

See the *Cluster Server Bundled Agents Reference Guide* for more information on the agent.

About running a fire drill in a campus cluster

This topic provides information on how to run a fire drill in campus clusters.

Do the following tasks to perform fire drill:

- [Configuring the fire drill service group](#)
- [Running a successful fire drill in a campus cluster](#)

Configuring the fire drill service group

This topic provides information on how to configure the fire drill service group.

To configure the fire drill service group

- 1 Configure a fire drill service group similar to the application service group with the following exceptions:
 - The `AutoFailOver` attribute must be set to 0.
 - Network-related resources must not be configured.
 - The disk group names for the `DiskGroup` and the `Mount` resources in the fire drill service group must be appended with `"_fd"`.
For example, if the value of the `DiskGroup` attribute in the application service group is `ccdg`, then the corresponding value in the fire drill service group must be `ccdg_fd`.
If the value of the `BlockDevice` attribute for the `Mount` resource in the application service group is `/dev/vx/dsk/ccdg/ccvol`, then the corresponding value in the fire drill service group must be `/dev/vx/dsk/ccdg_fd/ccvol`.
- 2 Add a resource of type `DiskGroupSnap`. Define the `TargetResName` and the `FDSiteName` attributes for the `DiskGroupSnap` resource.

See the *Cluster Server Bundled Agent Reference Guide* for attribute descriptions.
- 3 Create a dependency such that the `DiskGroup` resource depends on the `DiskGroupSnap` resource.
- 4 Create a group dependency such that the fire drill service group has an offline local dependency on the application service group.

Running a successful fire drill in a campus cluster

Bring the fire drill service group online on a node within the system zone that does not have the application running. Verify that the fire drill service group comes online. This action validates that your solution is configured correctly and the production service group will fail over to the remote site in the event of an actual failure (disaster) at the local site.

You must take the fire drill service group offline before you shut down the node or stop VCS locally on the node where the fire drill service group is online or where the disk group is online. Otherwise, after the node restarts you must manually reattach the fire drill site to the disk group that is imported at the primary site.

Note: For the applications for which you want to perform fire drill, you must set the value of the FireDrill attribute for those application resource types to 1. After you complete fire drill, reset the value to 0.

To run a successful fire drill

- 1** Override the FireDrill attribute at the resource level for resources of the fire drill service group.
- 2** Set the FireDrill attribute for the application resources to 1. This prevents the agent from reporting a concurrency violation, when the application service group and the fire drill service group are online at the same time.
- 3** Bring the fire drill service group online.

If the fire drill service group does not come online, review the VCS engine log to troubleshoot the issues so that corrective action can be taken as necessary in the production service group.

Warning: You must take the fire drill service group offline after you complete the fire drill so that the failover behavior of the application service group is not impacted. Otherwise, when a disaster strikes at the primary site, the application service group cannot fail over to the secondary site due to resource conflicts.

- 4** After you complete the fire drill, take the fire drill service group offline.
- 5** Reset the Firedrill attribute for the resource to 0.
- 6** Undo or override the Firedrill attribute from the resource level.

Troubleshooting and performance

- [Chapter 23. VCS performance considerations](#)
- [Chapter 24. Troubleshooting and recovery for VCS](#)

VCS performance considerations

This chapter includes the following topics:

- [How cluster components affect performance](#)
- [How cluster operations affect performance](#)
- [About scheduling class and priority configuration](#)
- [CPU binding of HAD](#)
- [VCS agent statistics](#)
- [About VCS tunable parameters](#)

How cluster components affect performance

VCS and its agents run on the same systems as the applications. Therefore, VCS attempts to minimize its impact on overall system performance. The main components of clustering that have an impact on performance include the kernel; specifically, GAB and LLT, the VCS engine (HAD), and the VCS agents. For details on attributes or commands mentioned in the following sections, see the chapter on administering VCS from the command line and the appendix on VCS attributes.

See [“How kernel components \(GAB and LLT\) affect performance”](#) on page 653.

See [“How the VCS engine \(HAD\) affects performance”](#) on page 653.

See [“How agents affect performance”](#) on page 654.

See [“How the VCS graphical user interfaces affect performance”](#) on page 655.

How kernel components (GAB and LLT) affect performance

Typically, overhead of VCS kernel components is minimal. Kernel components provide heartbeat and atomic information exchange among cluster systems. By default, each system in the cluster sends two small heartbeat packets per second to other systems in the cluster.

Heartbeat packets are sent over all network links configured in the `/etc/llttab` configuration file.

System-to-system communication is load-balanced across all private network links. If a link fails, VCS continues to use all remaining links. Typically, network links are private and do not increase traffic on the public network or LAN. You can configure a public network (LAN) link as low-priority, which by default generates a small (approximately 64-byte) unicast packet per second from each system, and which will carry data only when all private network links have failed.

How the VCS engine (HAD) affects performance

The VCS engine, HAD, runs as a daemon process. By default it runs as a high-priority process, which ensures it sends heartbeats to kernel components and responds quickly to failures. HAD runs logging activities in a separate thread to reduce the performance impact on the engine due to logging.

VCS runs in a loop waiting for messages from agents, `ha` commands, the graphical user interfaces, and the other systems. Under normal conditions, the number of messages processed by HAD is few. They mainly include heartbeat messages from agents and update messages from the global counter. VCS may exchange additional messages when an event occurs, but typically overhead is nominal even during events. Note that this depends on the type of event; for example, a resource fault may involve taking the group offline on one system and bringing it online on another system. A system fault invokes failing over all online service groups on the faulted system.

To continuously monitor VCS status, use the VCS graphical user interfaces or the command `hastatus`. Both methods maintain connection to VCS and register for events, and are more efficient compared to running commands like `hastatus -summary` or `hasys` in a loop.

The number of clients connected to VCS can affect performance if several events occur simultaneously. For example, if five GUI processes are connected to VCS, VCS sends state updates to all five. Maintaining fewer client connections to VCS reduces this overhead.

How agents affect performance

The VCS agent processes have the most impact on system performance. Each agent process has two components: the agent framework and the agent functions. The agent framework provides common functionality, such as communication with the HAD, multithreading for multiple resources, scheduling threads, and invoking functions. Agent functions implement agent-specific functionality. Review the performance guidelines to follow when configuring agents.

See [“Monitoring resource type and agent configuration”](#) on page 654.

Monitoring resource type and agent configuration

By default, VCS monitors each resource every 60 seconds. You can change this by modifying the `MonitorInterval` attribute for the resource type. You may consider reducing monitor frequency for non-critical or resources with expensive monitor operations. Note that reducing monitor frequency also means that VCS may take longer to detect a resource fault.

By default, VCS also monitors offline resources. This ensures that if someone brings the resource online outside of VCS control, VCS detects it and flags a concurrency violation for failover groups. To reduce the monitoring frequency of offline resources, modify the `OfflineMonitorInterval` attribute for the resource type.

The VCS agent framework uses multithreading to allow multiple resource operations to run in parallel for the same type of resources. For example, a single Mount agent handles all mount resources. The number of agent threads for most resource types is 10 by default. To change the default, modify the `NumThreads` attribute for the resource type. The maximum value of the `NumThreads` attribute is 30.

Continuing with this example, the Mount agent schedules the `monitor` function for all mount resources, based on the `MonitorInterval` or `OfflineMonitorInterval` attributes. If the number of mount resources is more than `NumThreads`, the monitor operation for some mount resources may be required to wait to execute the `monitor` function until the thread becomes free.

Additional considerations for modifying the `NumThreads` attribute include:

- If you have only one or two resources of a given type, you can set `NumThreads` to a lower value.
- If you have many resources of a given type, evaluate the time it takes for the `monitor` function to execute and the available CPU power for monitoring. For example, if you have 50 mount points, you may want to increase `NumThreads` to get the ideal performance for the Mount agent without affecting overall system performance.

You can also adjust how often VCS monitors various functions by modifying their associated attributes. The attributes `MonitorTimeout`, `OnlineTimeout`, and `OfflineTimeout` indicate the maximum time (in seconds) within which the monitor, online, and offline functions must complete or else be terminated. The default for the `MonitorTimeout` attribute is 60 seconds. The defaults for the `OnlineTimeout` and `OfflineTimeout` attributes is 300 seconds. For best results, Veritas recommends measuring the time it takes to bring a resource online, take it offline, and monitor before modifying the defaults. Issue an online or offline command to measure the time it takes for each action. To measure how long it takes to monitor a resource, fault the resource and issue a probe, or bring the resource online outside of VCS control and issue a probe.

Agents typically run with normal priority. When you develop agents, consider the following:

- If you write a custom agent, write the monitor function using C or C++. If you write a script-based monitor, VCS must invoke a new process each time with the monitor. This can be costly if you have many resources of that type.
- If monitoring the resources is proving costly, you can divide it into cursory, or shallow monitoring, and the more extensive deep (or in-depth) monitoring. Whether to use shallow or deep monitoring depends on your configuration requirements.

As an additional consideration for agents, properly configure the attribute `SystemList` for your service group. For example, if you know that a service group can go online on `SystemA` and `SystemB` only, do not include other systems in the `SystemList`. This saves additional agent processes and monitoring overhead.

How the VCS graphical user interfaces affect performance

The VCS graphical user interface, Cluster Manager (Java Console) maintains a persistent connection to HAD, from which it receives regular updates regarding cluster status. For best results, run the GUI on a system outside the cluster to avoid impact on node performance.

How cluster operations affect performance

Review the following topics that describe how the following operations on systems, resources, and service groups in the cluster affect performance:

A cluster system boots

See “[VCS performance consideration when booting a cluster system](#)” on page 656.

A resource comes online	See “ VCS performance consideration when a resource comes online ” on page 657.
A resource goes offline	See “ VCS performance consideration when a resource goes offline ” on page 657.
A service group comes online	See “ VCS performance consideration when a service group comes online ” on page 657.
A service group goes offline	See “ VCS performance consideration when a service group goes offline ” on page 658.
A resource fails	See “ VCS performance consideration when a resource fails ” on page 658.
A system fails	See “ VCS performance consideration when a system fails ” on page 659.
A network link fails	See “ VCS performance consideration when a network link fails ” on page 660.
A system panics	See “ VCS performance consideration when a system panics ” on page 660.
A service group switches over	See “ VCS performance consideration when a service group switches over ” on page 662.
A service group fails over	See “ VCS performance consideration when a service group fails over ” on page 663.

VCS performance consideration when booting a cluster system

When a cluster system boots, the kernel drivers and VCS process start in a particular order. If it is the first system in the cluster, VCS reads the cluster configuration file `main.cf` and builds an in-memory configuration database. This is the `LOCAL_BUILD` state. After building the configuration database, the system transitions into the `RUNNING` mode. If another system joins the cluster while the first system is in the `LOCAL_BUILD` state, it must wait until the first system transitions into `RUNNING` mode. The time it takes to build the configuration depends on the number of service groups in the configuration and their dependencies, and the number of resources per group and resource dependencies. VCS creates an object for each system, service group, type, and resource. Typically, the number of systems, service groups and types are few, so the number of resources and resource dependencies determine how long it takes to build the configuration database and get VCS into `RUNNING` mode. If a system joins a cluster in which at least one system is in `RUNNING` mode, it builds the configuration from the lowest-numbered system in that mode.

Note: Bringing service groups online as part of AutoStart occurs after VCS transitions to RUNNING mode.

VCS performance consideration when a resource comes online

The online function of an agent brings the resource online. This function may return before the resource is fully online. The subsequent monitor determines if the resource is online, then reports that information to VCS. The time it takes to bring a resource online equals the time for the resource to go online, plus the time for the subsequent monitor to execute and report to VCS.

Most resources are online when the online function finishes. The agent schedules the monitor immediately after the function finishes, so the first monitor detects the resource as online. However, for some resources, such as a database server, recovery can take longer. In this case, the time it takes to bring a resource online depends on the amount of data to recover. It may take multiple monitor intervals before a database server is reported online. When this occurs, it is important to have the correct values configured for the `OnlineTimeout` and `OnlineWaitLimit` attributes of the database server resource type.

VCS performance consideration when a resource goes offline

Similar to the online function, the offline function takes the resource offline and may return before the resource is actually offline. Subsequent monitoring confirms whether the resource is offline. The time it takes to offline a resource equals the time it takes for the resource to go offline, plus the duration of subsequent monitoring and reporting to VCS that the resource is offline. Most resources are typically offline when the offline function finishes. The agent schedules the monitor immediately after the offline function finishes, so the first monitor detects the resource as offline.

VCS performance consideration when a service group comes online

The time it takes to bring a service group online depends on the number of resources in the service group, the service group dependency structure, and the time to bring the group's resources online. For example, if service group G1 has three resources, R1, R2, and R3 (where R1 depends on R2 and R2 depends on R3), VCS first online R3. When R3 is online, VCS online R2. When R2 is online, VCS online R1. The time it takes to online G1 equals the time it takes to bring all resources online. However, if R1 depends on both R2 and R3, but there was no dependency between them, the online operation of R2 and R3 is started in parallel. When both are online, R1 is brought online. The time it takes to online the group is Max (the time to online R2 and R3), plus the time to online R1. Typically, broader service group trees allow more parallel operations and can be brought online faster. More

complex service group trees do not allow much parallelism and serializes the group online operation.

VCS performance consideration when a service group goes offline

Taking service groups offline works from the top down, as opposed to the online operation, which works from the bottom up. The time it takes to offline a service group depends on the number of resources in the service group and the time to offline the group's resources. For example, if service group G1 has three resources, R1, R2, and R3 where R1 depends on R2 and R2 depends on R3, VCS first offlines R1. When R1 is offline, VCS offlines R2. When R2 is offline, VCS offlines R3. The time it takes to offline G1 equals the time it takes for all resources to go offline.

VCS performance consideration when a resource fails

The time it takes to detect a resource fault or failure depends on the `MonitorInterval` attribute for the resource type. When a resource faults, the next monitor detects it. The agent may not declare the resource as faulted if the `ToleranceLimit` attribute is set to non-zero. If the `monitor` function reports offline more often than the number set in `ToleranceLimit`, the resource is declared faulted. However, if the resource remains online for the interval designated in the `ConfInterval` attribute, previous reports of offline are not counted against `ToleranceLimit`.

When the agent determines that the resource is faulted, it calls the clean function (if implemented) to verify that the resource is completely offline. The monitor following clean verifies the offline. The agent then tries to restart the resource according to the number set in the `RestartLimit` attribute (if the value of the attribute is non-zero) before it gives up and informs HAD that the resource is faulted. However, if the resource remains online for the interval designated in `ConfInterval`, earlier attempts to restart are not counted against `RestartLimit`.

In most cases, `ToleranceLimit` is 0. The time it takes to detect a resource failure is the time it takes the agent monitor to detect failure, plus the time to clean up the resource if the clean function is implemented. Therefore, the time it takes to detect failure depends on the `MonitorInterval`, the efficiency of the monitor and clean (if implemented) functions, and the `ToleranceLimit` (if set).

In some cases, the failed resource may hang and may also cause the monitor to hang. For example, if the database server is hung and the monitor tries to query, the monitor will also hang. If the `monitor` function is hung, the agent eventually kills the thread running the function. By default, the agent times out the `monitor` function after 60 seconds. This can be adjusted by changing the `MonitorTimeout` attribute. The agent retries monitor after the `MonitorInterval`. If the `monitor` function times out consecutively for the number of times designated in the attribute `FaultOnMonitorTimeouts`, the agent treats the resource as faulted. The agent calls

clean, if implemented. The default value of `FaultOnMonitorTimeouts` is 4, and can be changed according to the type. A high value of this parameter delays detection of a fault if the resource is hung. If the resource is hung and causes the `monitor` function to hang, the time to detect it depends on `MonitorTimeout`, `FaultOnMonitorTimeouts`, and the efficiency of `monitor` and `clean` (if implemented).

VCS performance consideration when a system fails

When a system crashes or is powered off, it stops sending heartbeats to other systems in the cluster. By default, other systems in the cluster wait 37 seconds before declaring it dead. The time of 37 seconds derives from 32 seconds default timeout value for LLT peer inactive timeout, plus 5 seconds default value for GAB stable timeout.

The default peer inactive timeout is 32 seconds, and can be modified in the `/etc/llttab` file.

For example, to specify 12 seconds:

```
set-timer peerinact:1200
```

Note: After modifying the peer inactive timeout, you must unconfigure, then restart LLT before the change is implemented. To unconfigure LLT, type `lltconfig -U`. To restart LLT, type `lltconfig -c`.

GAB stable timeout can be changed by specifying:

```
gabconfig -t timeout_value_milliseconds
```

Though this can be done, we do not recommend changing the values of the LLT peer inactive timeout and GAB stable timeout.

If a system boots, it becomes unavailable until the reboot is complete. The reboot process kills all processes, including HAD. When the VCS process is killed, other systems in the cluster mark all service groups that can go online on the rebooted system as `autodisabled`. The `AutoDisabled` flag is cleared when the system goes offline. As long as the system goes offline within the interval specified in the `ShutdownTimeout` value, VCS treats this as a system reboot. You can modify the default value of the `ShutdownTimeout` attribute.

See [System attributes](#) on page 816.

VCS performance consideration when a network link fails

If a system loses a network link to the cluster, other systems stop receiving heartbeats over the links from that system. LLT detects this and waits for 32 seconds before declaring the system lost a link.

See “[VCS performance consideration when a system fails](#)” on page 659.

You can modify the LLT peer inactive timeout value in the `/etc/llttab` file.

For example, to specify 12 seconds:

```
set-timer peerinact:1200
```

Note: After modifying the peer inactive timeout, you must unconfigure, then restart LLT before the change is implemented. To unconfigure LLT, type `lltconfig -U`. To restart LLT, type `lltconfig -c`.

VCS performance consideration when a system panics

There are several instances in which GAB will intentionally panic a system. For example, GAB panics a system if it detects an internal protocol error or discovers an LLT node-ID conflict. Other instances are as follows:

- Client process failure
See “[About GAB client process failure](#)” on page 660.
- Registration monitoring
See “[About GAB client registration monitoring](#)” on page 661.
- Network failure
See “[About network failure and GAB IOFENCE message](#)” on page 662.
- Quick reopen
See “[About quick reopen](#)” on page 662.

About GAB client process failure

If a GAB client process such as HAD fails to heartbeat to GAB, the process is killed. If the process hangs in the kernel and cannot be killed, GAB halts the system. If the `-k` option is used in the `gabconfig` command, GAB tries to kill the client process until successful, which may have an effect on the entire cluster. If the `-b` option is used in `gabconfig`, GAB does not try to kill the client process. Instead, it panics the system when the client process fails to heartbeat. This option cannot be turned off once set.

HAD heartbeats with GAB at regular intervals. The heartbeat timeout is specified by HAD when it registers with GAB; the default is 30 seconds. If HAD gets stuck within the kernel and cannot heartbeat with GAB within the specified timeout, GAB tries to kill HAD by sending a SIGABRT signal. If it does not succeed, GAB sends a SIGKILL and closes the port.

By default, GAB tries to kill HAD five times before closing the port. The number of times GAB tries to kill HAD is a kernel tunable parameter, `gab_kill_ntries`, and is configurable. The minimum value for this tunable is 3 and the maximum is 10.

Port closure is an indication to other nodes that HAD on this node has been killed. Should HAD recover from its stuck state, it first processes pending signals. Here it receive the SIGKILL first and get killed.

After GAB sends a SIGKILL signal, it waits for a specific amount of time for HAD to get killed. If HAD survives beyond this time limit, GAB panics the system. This time limit is a kernel tunable parameter, `gab_isolate_time`, and is configurable. The minimum value for this timer is 16 seconds and maximum is 4 minutes.

About GAB client registration monitoring

The registration monitoring feature lets you configure GAB behavior when HAD is killed and does not reconnect after a specified time interval.

This scenario may occur in the following situations:

- The system is very busy and the hashadow process cannot restart HAD.
- The HAD and hashadow processes were killed by user intervention.
- The hashadow process restarted HAD, but HAD could not register.
- A hardware failure causes termination of the HAD and hashadow processes.
- Any other situation where the HAD and hashadow processes are not run.

When this occurs, the registration monitoring timer starts. GAB takes action if HAD does not register within the time defined by the `VCS_GAB_RMTIMEOUT` parameter, which is defined in the `vcseenv` file. The default value for `VCS_GAB_RMTIMEOUT` is 200 seconds.

When HAD cannot register after the specified time period, GAB logs a message every 15 seconds saying it will panic the system.

You can control GAB behavior in this situation by setting the `VCS_GAB_RMACTION` parameter in the `vcseenv` file.

- To configure GAB to panic the system in this situation, set:

```
VCS_GAB_RMACTION=panic
```

In this configuration, killing the HAD and hashadow processes results in a panic unless you start HAD within the registration monitoring timeout interval.

- To configure GAB to log a message in this situation, set:

```
VCS_GAB_RMACTION=SYSLOG
```

The default value of this parameter is SYSLOG, which configures GAB to log a message when HAD does not reconnect after the specified time interval.

In this scenario, you can choose to restart HAD (using `hastart`) or unconfigure GAB (using `gabconfig -U`).

When you enable registration monitoring, GAB takes no action if the HAD process unregisters with GAB normally, that is if you stop HAD using the `hastop` command.

About network failure and GAB IOFENCE message

If a network partition occurs, a cluster can split into two or more separate sub-clusters. When two clusters join as one, GAB ejects one sub-cluster. GAB prints diagnostic messages and sends `iofence` messages to the sub-cluster being ejected.

The systems in the sub-cluster process the `iofence` messages depending on the type of GAB port that a user client process or a kernel module uses:

- If the GAB client is a user process, then GAB tries to kill the client process.
- If the GAB client is a kernel module, then GAB panics the system.

The `gabconfig` command's `-k` and `-j` options apply to the user client processes. The `-k` option prevents GAB from panicking the system when it cannot kill the user processes. The `-j` option panics the system and does not kill the user process when GAB receives the `iofence` message.

About quick reopen

If a system leaves cluster and tries to join the cluster before the new cluster is configured (default is five seconds), the system is sent an `iofence` message with reason set to "quick reopen". When the system receives the message, it tries to kill the client process.

VCS performance consideration when a service group switches over

The time it takes to switch a service group equals the time to offline a service group on the source system, plus the time to bring the service group online on the target system.

VCS performance consideration when a service group fails over

The time it takes to fail over a service group when a resource faults equals the following:

- The time it takes to detect the resource fault
- The time it takes to offline the service group on source system
- The time it takes for the VCS policy module to select target system
- The time it takes to bring the service group online on target system

The time it takes to fail over a service group when a system faults equals the following:

- The time it takes to detect system fault
- The time it takes to offline the dependent service groups on other running systems
- The time it takes for the VCS policy module to select target system
- The time it takes to bring the service group online on target system

The time it takes the VCS policy module to determine the target system is negligible in comparison to the other factors.

If you have a firm group dependency and the child group faults, VCS offlines all immediate and non-immediate parent groups before bringing the child group online on the target system. Therefore, the time it takes a parent group to be brought online also depends on the time it takes the child group to be brought online.

About scheduling class and priority configuration

VCS allows you to specify priorities and scheduling classes for VCS processes. VCS supports the following scheduling classes:

- RealTime (specified as "RT in the configuration file)
- TimeSharing (specified as "TS in the configuration file)

About priority ranges

[Table 23-1](#) displays the platform-specific priority range for RealTime, TimeSharing, and SRM scheduling (SHR) processes.

Table 23-1 Priority ranges

Platform	Scheduling class	Default priority range wWeak / strong	Priority range using #ps commands
AIX	RT	126 / 50	126 / 50
	TS	60	Priority varies with CPU consumption. Note: On AIX, use #ps -ael

Default scheduling classes and priorities

Table 23-2 lists the default class and priority values used by VCS. The class and priority of trigger processes are determined by the attributes ProcessClass (default = TS) and ProcessPriority (default = ""). Both attributes can be modified according to the class and priority at which the trigger processes run.

Table 23-2 Default scheduling classes and priorities

Process	Engine	Process created by engine	Agent	Script
Default scheduling class	RT	TS	TS	TS
Default priority (AIX)	52 (Strongest + 2)	0	0	0

Note: For standard configurations, Veritas recommends using the default values for scheduling unless specific configuration requirements dictate otherwise.

Note that the default priority value is platform-specific. When priority is set to "" (empty string), VCS converts the priority to a value specific to the platform on which the system is running. For TS, the default priority equals the strongest priority supported by the TimeSharing class. For RT, the default priority equals two less than the strongest priority supported by the RealTime class. So, if the strongest priority supported by the RealTime class is 59, the default priority for the RT class is 57.

About configuring priorities for LLT threads for AIX

In an highly loaded system, LLT threads might not be able to run because of relatively low priority settings. This situation may result in heartbeat failures across cluster nodes.

You can modify the priorities for the timer and service threads by configuring kernel tunables in the file `/etc/llt.conf`.

Following is a sample `llt.conf` file:

```
llt_maxnids=32
llt_maxports=32
llt_nominpad=0
llt_basetimer=50000
llt_thread_pri=40
```

Table 23-3 depicts the priorities for LLT threads for AIX.

Table 23-3 Priorities for LLT threads for AIX

LLT thread	Default priority	Priority range	Tunable to configure thread priority
LLT service thread	40	40 to 60	llt_thread_pri

Note that the priorities must lie within the priority range. If you specify a priority outside the range, LLT resets it to a value within the range.

To specify priorities for LLT threads

- ◆ Specify priorities for these tunables by setting the following entries in the file `/etc/llt.conf`:

```
llt_thread_pri=<priority value>
```

Note that these changes take effect when the LLT module reloads.

CPU binding of HAD

In certain situations, the AIX operating systems may assign high priority interrupt threads to the logical CPU on which HAD is running, thereby interrupting HAD.

In this scenario, HAD cannot function until the interrupt handler completes its operation.

To overcome this issue, VCS provides the option of running HAD on a specific logical processor. VCS disables all interrupts on that logical processor. Configure HAD to run on a specific logical processor by setting the CPUBinding attribute.

Note: CPU binding of HAD is supported only on AIX 6.1 TL6 or later and AIX 7.1.

See [System attributes](#) on page 816.

Use the following command to modify the CPUBinding attribute:

```
hasys -modify sys1 CPUBinding BindTo  
NONE|ANY|CPUNUM [CPUNumber number]
```

where:

- The value NONE indicates that HAD does not use CPU binding.
- The value ANY indicates that HAD binds to any available logical CPU.
- The value CPUNUM indicates that HAD binds to the logical CPU specified in the CPUNumber attribute.

The variable *number* specifies the serial number of the logical CPU.

Warning: Veritas recommends that you modify CPUBinding on the local system. If you specify an invalid processor number when you try to bind HAD to a processor on remote system, HAD does not bind to any CPU. The command displays no error that the CPU does not exist.

Note: You cannot use the -add, -update, or -delete [-keys] options for the hasys -modify command to modify the CPUBinding attribute.

In certain scenarios, when HAD is killed or is not running, the logical CPU interrupts might remain disabled. However, you can enable the interrupts manually. To check for the logical processor IDs that have interrupts disabled, run the following command:

```
# cpuextintr_ctl -q disable
```

To enable interrupts on a logical processor ID, run the following command:

```
# cpuextintr_ctl -C processor_id -i enable
```

VCS agent statistics

You can configure VCS to track the time taken for monitoring resources.

You can use these statistics to configure the MonitorTimeout attribute.

You can also detect potential problems with resources and systems on which resources are online by analyzing the trends in the time taken by the resource's monitor cycle. Note that VCS keeps track of monitor cycle times for online resources only.

VCS calculates the time taken for a monitor cycle to complete and computes an average of monitor times after a specific number of monitor cycles and stores the average in a resource-level attribute.

VCS also tracks increasing trends in the monitor cycle times and sends notifications about sudden and gradual increases in monitor times.

VCS uses the following parameters to compute the average monitor time and to detect increasing trends in monitor cycle times:

- **Frequency:** The number of monitor cycles after which the monitor time average is computed and sent to the VCS engine.
For example, if Frequency is set to 10, VCS computes the average monitor time after every 10 monitor cycles.
- **ExpectedValue:** The expected monitor time (in milliseconds) for a resource.
VCS sends a notification if the actual monitor time exceeds the expected monitor time by the ValueThreshold. So, if you set this attribute to 5000 for a FileOnOff resource, and if ValueThreshold is set to 40%, VCS will send a notification only when the monitor cycle for the FileOnOff resource exceeds the expected time by over 40%, that is 7000 milliseconds.
- **ValueThreshold:** The maximum permissible deviation (in percent) from the expected monitor time. When the time for a monitor cycle exceeds this limit, VCS sends a notification about the sudden increase or decrease in monitor time.
For example, a value of 100 means that VCS sends a notification if the actual monitor time deviates from the expected time by over 100%.
VCS sends these notifications conservatively. If 12 consecutive monitor cycles exceed the threshold limit, VCS sends a notification for the first spike, and then a collective notification for the next 10 consecutive spikes.
- **AvgThreshold:** The threshold value (in percent) for increase in the average monitor cycle time for a resource.
VCS maintains a running average of the time taken by the monitor cycles of a resource. The first such computed running average is used as a benchmark average. If the current running average for a resource differs from the benchmark

average by more than this threshold value, VCS regards this as a sign of gradual increase or decrease in monitor cycle times and sends a notification about it for the resource. Whenever such an event occurs, VCS resets the internally maintained benchmark average to this new average. VCS sends notifications regardless of whether the deviation is an increase or decrease in the monitor cycle time.

For example, a value of 25 means that if the actual average monitor time is 25% more than the benchmark monitor time average, VCS sends a notification.

Tracking monitor cycle times

VCS marks sudden changes in monitor times by comparing the time taken for each monitor cycle with the `ExpectedValue`. If this difference exceeds the `ValueThreshold`, VCS sends a notification about the sudden change in monitor time. Note that VCS sends this notification only if monitor time increases.

VCS marks gradual changes in monitor times by comparing the benchmark average and the moving average of monitor cycle times. VCS computes the benchmark average after a certain number of monitor cycles and computes the moving average after every monitor cycle. If the current moving average exceeds the benchmark average by more than the `AvgThreshold`, VCS sends a notification about this gradual change in the monitor cycle time.

VCS attributes enabling agent statistics

This topic describes the attributes that enable VCS agent statistics.

MonitorStatsParam A resource type-level attribute, which stores the required parameter values for calculating monitor time statistics.

```
static str MonitorStatsParam = { Frequency = 10,  
ExpectedValue = 3000, ValueThreshold = 100,  
AvgThreshold = 40 }
```

- **Frequency:** Defines the number of monitor cycles after which the average monitor cycle time should be computed and sent to the engine. If configured, the value for this attribute must be between 1 and 30. It is set to 0 by default.
- **ExpectedValue:** The expected monitor time in milliseconds for all resources of this type. Default=3000.
- **ValueThreshold:** The acceptable percentage difference between the expected monitor cycle time (ExpectedValue) and the actual monitor cycle time. Default=100.
- **AvgThreshold:** The acceptable percentage difference between the benchmark average and the moving average of monitor cycle times. Default=40

MonitorTimeStats Stores the average time taken by a number of monitor cycles specified by the Frequency attribute along with a timestamp value of when the average was computed.

```
str MonitorTimeStats{} = { Avg = "0", TS = "" }
```

This attribute is updated periodically after a number of monitor cycles specified by the Frequency attribute. If Frequency is set to 10, the attribute stores the average of 10 monitor cycle times and is updated after every 10 monitor cycles.

The default value for this attribute is 0.

ComputeStats A flag that specifies whether VCS keeps track of the monitor times for the resource.

```
boolean ComputeStats = 0
```

The value 0 indicates that VCS will not keep track of the time taken by the monitor routine for the resource. The value 1 indicates that VCS keeps track of the monitor time for the resource.

The default value for this attribute is 0.

About VCS tunable parameters

VCS has some tunable parameters that you can configure to enhance the performance of specific features. However, Veritas Technologies recommends that

the user not change the tunable kernel parameters without assistance from Veritas Technologies support personnel. Several of the tunable parameters preallocate memory for critical data structures, and a change in their values could increase memory use or degrade performance.

Warning: Do not adjust the VCS tunable parameters for kernel modules such as VXFEN without assistance from Veritas Technologies support personnel.

About LLT tunable parameters

LLT provides various configuration and tunable parameters to modify and control the behavior of the LLT module. This section describes some of the LLT tunable parameters that can be changed at run-time and at LLT start-time.

See [“About Low Latency Transport \(LLT\)”](#) on page 311.

The tunable parameters are classified into two categories:

- LLT timer tunable parameters
See [“About LLT timer tunable parameters”](#) on page 670.
- LLT flow control tunable parameters
See [“About LLT flow control tunable parameters”](#) on page 674.

See [“Setting LLT timer tunable parameters”](#) on page 677.

About LLT timer tunable parameters

[Table 23-4](#) lists the LLT timer tunable parameters. The timer values are set in .01 sec units. The command `lltconfig -T query` can be used to display current timer values.

Table 23-4 LLT timer tunable parameters

LLT parameter	Description	Default	When to change	Dependency with other LLT tunable parameters
peerinact	<p>LLT marks a link of a peer node as "inactive," if it does not receive any packet on that link for this timer interval. Once a link is marked as "inactive," LLT will not send any data on that link.</p>	3200	<ul style="list-style-type: none"> ■ Change this value for delaying or speeding up node/link inactive notification mechanism as per client's notification processing logic. ■ Increase the value for planned replacement of faulty network cable /switch. ■ In some circumstances, when the private networks links are very slow or the network traffic becomes very bursty, increase this value so as to avoid false notifications of peer death. Set the value to a high value for planned replacement of faulty network cable or faulty switch. 	<p>The timer value should always be higher than the peertrouble timer value.</p>
peertrouble	<p>LLT marks a high-pri link of a peer node as "troubled", if it does not receive any packet on that link for this timer interval. Once a link is marked as "troubled", LLT will not send any data on that link till the link is up.</p>	200	<ul style="list-style-type: none"> ■ In some circumstances, when the private networks links are very slow or nodes in the cluster are very busy, increase the value. ■ Increase the value for planned replacement of faulty network cable /faulty switch. 	<p>This timer value should always be lower than peerinact timer value. Also, It should be close to its default value.</p>

Table 23-4 LLT timer tunable parameters (*continued*)

LLT parameter	Description	Default	When to change	Dependency with other LLT tunable parameters
peertroublelo	LLT marks a low-pri link of a peer node as "troubled", if it does not receive any packet on that link for this timer interval. Once a link is marked as "troubled", LLT will not send any data on that link till the link is available.	400	<ul style="list-style-type: none"> ■ In some circumstances, when the private networks links are very slow or nodes in the cluster are very busy, increase the value. ■ Increase the value for planned replacement of faulty network cable /faulty switch. 	This timer value should always be lower than peerinact timer value. Also, It should be close to its default value.
heartbeat	LLT sends heartbeat packets repeatedly to peer nodes after every heartbeat timer interval on each highpri link.	50	In some circumstances, when the private networks links are very slow (or congested) or nodes in the cluster are very busy, increase the value.	This timer value should be lower than peertrouble timer value. Also, it should not be close to peertrouble timer value.
heartbeatlo	LLT sends heartbeat packets repeatedly to peer nodes after every heartbeatlo timer interval on each low pri link.	100	In some circumstances, when the networks links are very slow or nodes in the cluster are very busy, increase the value.	This timer value should be lower than peertroublelo timer value. Also, it should not be close to peertroublelo timer value.
timetoreqhb	If LLT does not receive any packet from the peer node on a particular link for "timetoreqhb" time period, it attempts to request heartbeats (sends 5 special heartbeat requests (hbreqs) to the peer node on the same link) from the peer node. If the peer node does not respond to the special heartbeat requests, LLT marks the link as "expired" for that peer node. The value can be set from the range of 0 to (peerinact -200). The value 0 disables the request heartbeat mechanism.	3000	<p>Decrease the value of this tunable for speeding up node/link inactive notification mechanism as per client's notification processing logic.</p> <p>Disable the request heartbeat mechanism by setting the value of this timer to 0 for planned replacement of faulty network cable /switch.</p> <p>In some circumstances, when the private networks links are very slow or the network traffic becomes very bursty, don't change the value of this timer tunable.</p>	This timer is set to 'peerinact - 200' automatically every time when the peerinact timer is changed.

Table 23-4 LLT timer tunable parameters (*continued*)

LLT parameter	Description	Default	When to change	Dependency with other LLT tunable parameters
reqhbtme	This value specifies the time interval between two successive special heartbeat requests. See the timetoreqhb parameter for more information on special heartbeat requests.	40	Veritas does not recommend to change this value	Not applicable
timetosendhb	LLT sends out of timer context heartbeats to keep the node alive when LLT timer does not run at regular interval. This option specifies the amount of time to wait before sending a heartbeat in case of timer not running. If this timer tunable is set to 0, the out of timer context heartbeating mechanism is disabled.	200	Disable the out of timer context heart-beating mechanism by setting the value of this timer to 0 for planned replacement of faulty network cable /switch. In some circumstances, when the private networks links are very slow or nodes in the cluster are very busy, increase the value	This timer value should not be more than peerinact timer value. Also, it should not be close to the peerinact timer value.
sendhbcap	This value specifies the maximum time for which LLT will send contiguous out of timer context heartbeats.	18000	Veritas does not recommend this value.	NA
oos	If the out-of-sequence timer has expired for a node, LLT sends an appropriate NAK to that node. LLT does not send a NAK as soon as it receives an oos packet. It waits for the oos timer value before sending the NAK.	10	Do not change this value for performance reasons. Lowering the value can result in unnecessary retransmissions/negative acknowledgement traffic. You can increase the value of oos if the round trip time is large in the cluster (for example, campus cluster).	Not applicable

Table 23-4 LLT timer tunable parameters (*continued*)

LLT parameter	Description	Default	When to change	Dependency with other LLT tunable parameters
retrans	LLT retransmits a packet if it does not receive its acknowledgement for this timer interval value.	10	Do not change this value. Lowering the value can result in unnecessary retransmissions. You can increase the value of retrans if the round trip time is large in the cluster (for example, campus cluster).	Not applicable
service	LLT calls its service routine (which delivers messages to LLT clients) after every service timer interval.	100	Do not change this value for performance reasons.	Not applicable
arp	LLT flushes stored address of peer nodes when this timer expires and relearns the addresses.	0	This feature is disabled by default.	Not applicable
arpreq	LLT sends an arp request when this timer expires to detect other peer nodes in the cluster.	3000	Do not change this value for performance reasons.	Not applicable

About LLT flow control tunable parameters

[Table 23-5](#) lists the LLT flow control tunable parameters. The flow control values are set in number of packets. The command `lltconfig -F query` can be used to display current flow control settings.

Table 23-5 LLT flow control tunable parameters

LLT parameter	Description	Default	When to change	Dependency with other LLT tunable parameters
highwater	When the number of packets in transmit queue for a node reaches highwater, LLT is flow controlled.	200	If a client generates data in bursty manner, increase this value to match the incoming data rate. Note that increasing the value means more memory consumption so set an appropriate value to avoid wasting memory unnecessarily. Lowering the value can result in unnecessary flow controlling the client.	This flow control value should always be higher than the lowwater flow control value.
lowwater	When LLT has flow controlled the client, it will not start accepting packets again till the number of packets in the port transmit queue for a node drops to lowwater.	100	Veritas does not recommend to change this tunable.	This flow control value should be lower than the highwater flow control value. The value should not be close the highwater flow control value.
rpothighwater	When the number of packets in the receive queue for a port reaches highwater, LLT is flow controlled.	200	If a client generates data in bursty manner, increase this value to match the incoming data rate. Note that increasing the value means more memory consumption so set an appropriate value to avoid wasting memory unnecessarily. Lowering the value can result in unnecessary flow controlling the client on peer node.	This flow control value should always be higher than the rportlowwater flow control value.
rportlowwater	When LLT has flow controlled the client on peer node, it will not start accepting packets for that client again till the number of packets in the port receive queue for the port drops to rportlowwater.	100	Veritas does not recommend to change this tunable.	This flow control value should be lower than the rpothighwater flow control value. The value should not be close the rpothighwater flow control value.

Table 23-5 LLT flow control tunable parameters (*continued*)

LLT parameter	Description	Default	When to change	Dependency with other LLT tunable parameters
window	This is the maximum number of un-ACKed packets LLT will put in flight.	50	Change the value as per the private networks speed. Lowering the value irrespective of network speed may result in unnecessary retransmission of out of window sequence packets.	This flow control value should not be higher than the difference between the highwater flow control value and the lowwater flow control value. The value of this parameter (window) should be aligned with the value of the bandwidth delay product.
linkburst	It represents the number of back-to-back packets that LLT sends on a link before the next link is chosen.	32	For performance reasons, its value should be either 0 or at least 32.	This flow control value should not be higher than the difference between the highwater flow control value and the lowwater flow control value.
ackval	LLT sends acknowledgement of a packet by piggybacking an ACK packet on the next outbound data packet to the sender node. If there are no data packets on which to piggyback the ACK packet, LLT waits for ackval number of packets before sending an explicit ACK to the sender.	10	Do not change this value for performance reasons. Increasing the value can result in unnecessary retransmissions.	Not applicable
sws	To avoid Silly Window Syndrome, LLT transmits more packets only when the count of un-acked packet goes to below of this tunable value.	40	For performance reason, its value should be changed whenever the value of the window tunable is changed as per the formula given below: $sws = window * 4/5$.	Its value should be lower than that of window. Its value should be close to the value of window tunable.
largepktlen	When LLT has packets to delivers to multiple ports, LLT delivers one large packet or up to five small packets to a port at a time. This parameter specifies the size of the large packet.	1024	Veritas does not recommend to change this tunable.	Not applicable

Setting LLT timer tunable parameters

You can set the LLT tunable parameters either with the `lltconfig` command or in the `/etc/llttab` file. You can use the `lltconfig` command to change a parameter on the local node at run time. Veritas recommends you run the command on all the nodes in the cluster to change the values of the parameters. To set an LLT parameter across system reboots, you must include the parameter definition in the `/etc/llttab` file. Default values of the parameters are taken if nothing is specified in `/etc/llttab`. The parameters values specified in the `/etc/llttab` file come into effect at LLT start-time only. Veritas recommends that you specify the same definition of the tunable parameters in the `/etc/llttab` file of each node.

To get and set a timer tunable:

- To get the current list of timer tunable parameters using `lltconfig` command:

```
# lltconfig -T query
```

- To set a timer tunable parameter using the `lltconfig` command:

```
# lltconfig -T timer tunable:value
```

- To set a timer tunable parameter in the `/etc/llttab` file:

```
set-timer timer tunable:value
```

To get and set a flow control tunable

- To get the current list of flow control tunable parameters using `lltconfig` command:

```
# lltconfig -F query
```

- To set a flow control tunable parameter using the `lltconfig` command:

```
# lltconfig -F flowcontrol tunable:value
```

- To set a flow control tunable parameter in the `/etc/llttab` file:

```
set-flow flowcontrol tunable:value
```

See the `lltconfig(1M)` and `llttab(1M)` manual pages.

About GAB tunable parameters

GAB provides various configuration and tunable parameters to modify and control the behavior of the GAB module.

See [“About Group Membership Services/Atomic Broadcast \(GAB\)”](#) on page 310.

These tunable parameters not only provide control of the configurations like maximum possible number of nodes in the cluster, but also provide control on how GAB behaves when it encounters a fault or a failure condition. Some of these tunable parameters are needed when the GAB module is loaded into the system. Any changes to these load-time tunable parameters require either unload followed by reload of GAB module or system reboot. Other tunable parameters (run-time) can be changed while GAB module is loaded, configured, and cluster is running. Any changes to such a tunable parameter will have immediate effect on the tunable parameter values and GAB behavior.

See [“About GAB load-time or static tunable parameters”](#) on page 678.

See [“About GAB run-time or dynamic tunable parameters”](#) on page 680.

About GAB load-time or static tunable parameters

[Table 23-6](#) lists the static tunable parameters in GAB that are used during module load time. Use the `gabconfig -e` command to list all such GAB tunable parameters.

You can modify these tunable parameters only by adding new values in the GAB configuration file. The changes take effect only on reboot or on reload of the GAB module.

Table 23-6 GAB static tunable parameters

GAB parameter	Description	Values (default and range)
numnids	Maximum number of nodes in the cluster	Default: 64 Range: 1-64
numports	Maximum number of ports in the cluster	Default: 32 Range: 1-32
flowctrl	Number of pending messages in GAB queues (send or receive) before GAB hits flow control. This can be overwritten while cluster is up and running with the <code>gabconfig -Q</code> option. Use the <code>gabconfig</code> command to control value of this tunable.	Default: 128 Range: 1-1024

Table 23-6 GAB static tunable parameters (*continued*)

GAB parameter	Description	Values (default and range)
logbufsize	GAB internal log buffer size in bytes	Default: 48100 Range: 8100-65400
msglogsize	Maximum messages in internal message log	Default: 256 Range: 128-4096
isolate_time	Maximum time to wait for isolated client Can be overridden at runtime See "About GAB run-time or dynamic tunable parameters" on page 680.	Default: 120000 msec (2 minutes) Range: 160000-240000 (in msec)
kill_ntries	Number of times to attempt to kill client Can be overridden at runtime See "About GAB run-time or dynamic tunable parameters" on page 680.	Default: 5 Range: 3-10
conn_wait	Maximum number of wait periods (as defined in the stable timeout parameter) before GAB disconnects the node from the cluster during cluster reconfiguration	Default: 12 Range: 1-256
ibuf_count	Determines whether the GAB logging daemon is enabled or disabled The GAB logging daemon is enabled by default. To disable, change the value of <code>gab_ibuf_count</code> to 0. The disable login to the gab daemon while cluster is up and running with the <code>gabconfig -K</code> option. Use the <code>gabconfig</code> command to control value of this tunable.	Default: 8 Range: 0-32
timer_pri	Priority of GAB timer thread on AIX	Default: 17 Range: 2-60

About GAB run-time or dynamic tunable parameters

You can change the GAB dynamic tunable parameters while GAB is configured and while the cluster is running. The changes take effect immediately on running the `gabconfig` command. Note that some of these parameters also control how GAB behaves when it encounters a fault or a failure condition. Some of these conditions can trigger a PANIC which is aimed at preventing data corruption.

You can display the default values using the `gabconfig -l` command. To make changes to these values persistent across reboots, you can append the appropriate command options to the `/etc/gabtab` file along with any existing options. For example, you can add the `-k` option to an existing `/etc/gabtab` file that might read as follows:

```
gabconfig -c -n4
```

After adding the option, the `/etc/gabtab` file looks similar to the following:

```
gabconfig -c -n4 -k
```

[Table 23-7](#) describes the GAB dynamic tunable parameters as seen with the `gabconfig -l` command, and specifies the command to modify them.

Table 23-7 GAB dynamic tunable parameters

GAB parameter	Description and command
Control port seed	<p>This option defines the minimum number of nodes that can form the cluster. This option controls the forming of the cluster. If the number of nodes in the cluster is less than the number specified in the <code>gabtab</code> file, then the cluster will not form. For example: if you type <code>gabconfig -c -n4</code>, then the cluster will not form until all four nodes join the cluster. If this option is enabled using the <code>gabconfig -x</code> command then the node will join the cluster even if the other nodes in the cluster are not yet part of the membership.</p> <p>Use the following command to set the number of nodes that can form the cluster:</p> <pre>gabconfig -n count</pre> <p>Use the following command to enable control port seed. Node can form the cluster without waiting for other nodes for membership:</p> <pre>gabconfig -x</pre>

Table 23-7 GAB dynamic tunable parameters (*continued*)

GAB parameter	Description and command
<p>Halt on process death</p>	<p>Default: Disabled</p> <p>This option controls GAB's ability to halt (panic) the system on user process death. If <code>_had</code> and <code>_hashadow</code> are killed using <code>kill -9</code>, the system can potentially lose high availability. If you enable this option, then the GAB will PANIC the system on detecting the death of the client process. The default behavior is to disable this option.</p> <p>Use the following command to enable halt system on process death:</p> <pre>gabconfig -p</pre> <p>Use the following command to disable halt system on process death:</p> <pre>gabconfig -P</pre>
<p>Missed heartbeat halt</p>	<p>Default: Disabled</p> <p>If this option is enabled then the system will panic on missing the first heartbeat from the VCS engine or the <code>vxconfigd</code> daemon in a CVM environment. The default option is to disable the immediate panic.</p> <p>This GAB option controls whether GAB can panic the node or not when the VCS engine or the <code>vxconfigd</code> daemon miss to heartbeat with GAB. If the VCS engine experiences a hang and is unable to heartbeat with GAB, then GAB will NOT PANIC the system immediately. GAB will first try to abort the process by sending SIGABRT (<code>kill_ntries</code> - default value 5 times) times after an interval of "iofence_timeout" (default value 15 seconds). If this fails, then GAB will wait for the "isolate timeout" period which is controlled by a global tunable called <code>isolate_time</code> (default value 2 minutes). If the process is still alive, then GAB will PANIC the system.</p> <p>If this option is enabled GAB will immediately HALT the system in case of missed heartbeat from client.</p> <p>Use the following command to enable system halt when process heartbeat fails:</p> <pre>gabconfig -b</pre> <p>Use the following command to disable system halt when process heartbeat fails:</p> <pre>gabconfig -B</pre>

Table 23-7 GAB dynamic tunable parameters (*continued*)

GAB parameter	Description and command
Halt on rejoin	<p data-bbox="556 319 723 348">Default: Disabled</p> <p data-bbox="556 366 1216 626">This option allows the user to configure the behavior of the VCS engine or any other user process when one or more nodes rejoin a cluster after a network partition. By default GAB will not PANIC the node running the VCS engine. GAB kills the userland process (the VCS engine or the vxconfigd process). This recycles the user port (port h in case of the VCS engine) and clears up messages with the old generation number programmatically. Restart of the process, if required, must be handled outside of GAB control, e.g., for hashadow process restarts <code>_had</code>.</p> <p data-bbox="556 644 1216 756">When GAB has kernel clients (such as fencing, VxVM, or VxFS), then the node will always PANIC when it rejoins the cluster after a network partition. The PANIC is mandatory since this is the only way GAB can clear ports and remove old messages.</p> <p data-bbox="556 774 1123 803">Use the following command to enable system halt on rejoin:</p> <pre data-bbox="556 821 713 850">gabconfig -j</pre> <p data-bbox="556 868 1123 897">Use the following command to disable system halt on rejoin:</p> <pre data-bbox="556 914 713 944">gabconfig -J</pre>
Keep on killing	<p data-bbox="556 1001 723 1031">Default: Disabled</p> <p data-bbox="556 1048 1216 1187">If this option is enabled, then GAB prevents the system from PANICKING when the VCS engine or the vxconfigd process fail to heartbeat with GAB and GAB fails to kill the VCS engine or the vxconfigd process. GAB will try to continuously kill the VCS engine and will not panic if the kill fails.</p> <p data-bbox="556 1204 1009 1234">Repeat attempts to kill process if it does not die</p> <pre data-bbox="556 1251 713 1281">gabconfig -k</pre>

Table 23-7 GAB dynamic tunable parameters (*continued*)

GAB parameter	Description and command
<p>Quorum flag</p>	<p>Default: Disabled</p> <p>This is an option in GAB which allows a node to IOFENCE (resulting in a PANIC) if the new membership set is < 50% of the old membership set. This option is typically disabled and is used when integrating with other products</p> <p>Enable iofence quorum</p> <pre>gabconfig -q</pre> <p>Disable iofence quorum</p> <pre>gabconfig -d</pre>
<p>GAB queue limit</p>	<p>Default: Send queue limit: 128</p> <p>Default: Recv queue limit: 128</p> <p>GAB queue limit option controls the number of pending message before which GAB sets flow. Send queue limit controls the number of pending message in GAB send queue. Once GAB reaches this limit it will set flow control for the sender process of the GAB client. GAB receive queue limit controls the number of pending message in GAB receive queue before GAB send flow control for the receive side.</p> <p>Set the send queue limit to specified value</p> <pre>gabconfig -Q sendq:value</pre> <p>Set the receive queue limit to specified value</p> <pre>gabconfig -Q recvq:value</pre>
<p>IOFENCE timeout</p>	<p>Default: 15000(ms)</p> <p>This parameter specifies the timeout (in milliseconds) for which GAB will wait for the clients to respond to an IOFENCE message before taking next action. Based on the value of kill_ntries , GAB will attempt to kill client process by sending SIGABRT signal. If the client process is still registered after GAB attempted to kill client process for the value of kill_ntries times, GAB will halt the system after waiting for additional isolate_timeout value.</p> <p>Set the iofence timeout value to specified value in milliseconds.</p> <pre>gabconfig -f value</pre>

Table 23-7 GAB dynamic tunable parameters (*continued*)

GAB parameter	Description and command
Stable timeout	<p>Default: 5000(ms)</p> <p>Specifies the time GAB waits to reconfigure membership after the last report from LLT of a change in the state of local node connections for a given port. Any change in the state of connections will restart GAB waiting period.</p> <p>Set the stable timeout to specified value</p> <pre>gabconfig -t stable</pre>
Isolate timeout	<p>Default: 120000(ms)</p> <p>This tunable specifies the timeout value for which GAB will wait for client process to unregister in response to GAB sending SIGKILL signal. If the process still exists after isolate timeout GAB will halt the system</p> <pre>gabconfig -S isolate_time:value</pre>
Kill_ntries	<p>Default: 5</p> <p>This tunable specifies the number of attempts GAB will make to kill the process by sending SIGABRT signal.</p> <pre>gabconfig -S kill_ntries:value</pre>
Driver state	<p>This parameter shows whether GAB is configured. GAB may not have seeded and formed any membership yet.</p>
Partition arbitration	<p>This parameter shows whether GAB is asked to specifically ignore jeopardy.</p> <p>See the <code>gabconfig</code> (1M) manual page for details on the <code>-s</code> flag.</p>

About VXFEN tunable parameters

The section describes the VXFEN tunable parameters and how to reconfigure the VXFEN module.

[Table 23-8](#) describes the tunable parameters for the VXFEN driver.

Table 23-8 VXFEN tunable parameters

vxfen Parameter	Description and Values: Default, Minimum, and Maximum
vxfen_deblog_sz	<p>Size of debug log in bytes</p> <ul style="list-style-type: none"> ■ Values <ul style="list-style-type: none"> Default: 131072 (128 KB) Minimum: 65536 (64 KB) Maximum: 524288 (512 KB)
vxfen_max_delay	<p>Specifies the maximum number of seconds that the smaller sub-cluster waits before racing with larger sub-clusters for control of the coordinator disks when a network partition occurs.</p> <p>This value must be greater than the vxfen_min_delay value.</p> <ul style="list-style-type: none"> ■ Values <ul style="list-style-type: none"> Default: 60 Minimum: 1 Maximum: 600
vxfen_min_delay	<p>Specifies the minimum number of seconds that the smaller sub-cluster waits before racing with larger sub-clusters for control of the coordinator disks when a network partition occurs.</p> <p>This value must be smaller than or equal to the vxfen_max_delay value.</p> <ul style="list-style-type: none"> ■ Values <ul style="list-style-type: none"> Default: 1 Minimum: 1 Maximum: 600
vxfen_vxfnd_tmt	<p>Specifies the time in seconds that the I/O fencing driver VxFEN waits for the I/O fencing daemon VXFEND to return after completing a given task.</p> <ul style="list-style-type: none"> ■ Values <ul style="list-style-type: none"> Default: 60 Minimum: 10 Maximum: 600

Table 23-8 VXFEN tunable parameters (*continued*)

vxfen Parameter	Description and Values: Default, Minimum, and Maximum
panic_timeout_offst	<p>Specifies the time in seconds based on which the I/O fencing driver VxFEN computes the delay to pass to the GAB module to wait until fencing completes its arbitration before GAB implements its decision in the event of a split-brain. You can set this parameter in the <code>vxfenmode</code> file and use the <code>vxfenadm</code> command to check the value. Depending on the <code>vxfen_mode</code>, the GAB delay is calculated as follows:</p> <ul style="list-style-type: none">■ For scsi3 mode: $1000 * (\text{panic_timeout_offst} + \text{vxfen_max_delay})$■ For customized mode: $1000 * (\text{panic_timeout_offst} + \max(\text{vxfen_vxfnd_tmt}, \text{vxfen_loser_exit_delay}))$■ Default: 10

In the event of a network partition, the smaller sub-cluster delays before racing for the coordinator disks. The time delay allows a larger sub-cluster to win the race for the coordinator disks. The `vxfen_max_delay` and `vxfen_min_delay` parameters define the delay in seconds.

Configuring the VXFEN module parameters

After adjusting the tunable kernel driver parameters, you must reconfigure the VXFEN module for the parameter changes to take effect.

The following example procedure changes the value of the `vxfen_min_delay` parameter.

Note: You must restart the VXFEN module to put any parameter change into effect.

To configure the VxFEN parameters and reconfigure the VxFEN module

- 1 Check the status of the driver and start the driver if necessary:

```
# /etc/methods/vxfenext -status
```

To start the driver:

```
# /etc/init.d/vxfen.rc start
```

- 2 List the current value of the tunable parameter:

For example:

```
# lsattr -El vxfen
```

```
vxfen_deblog_sz 65536 N/A True
vxfen_max_delay 3 N/A True
vxfen_min_delay 1 N/A True
vxfen_vxfnd_tmt 60 N/A True
```

The current value of the `vxfen_min_delay` parameter is 1 (the default).

- 3 Enter the following command to change the `vxfen_min_delay` parameter value:

```
# chdev -l vxfen -P -a vxfen_min_delay=30
```

- 4 Ensure that VCS is shut down. Stop I/O fencing if configured.

```
# /etc/init.d/vxfen.rc stop
```

- 5 Ensure that VCS is shut down. Unload and reload the driver after changing the value of the tunable:

```
# /etc/methods/vxfenext -stop
```

```
# /etc/methods/vxfenext -start
```

- 6 Repeat the above steps on each cluster node to change the parameter.

- 7 Start VCS.

```
# hstart
```

About AMF tunable parameters

You can set the Asynchronous Monitoring Framework (AMF) kernel module tunable using the following command:

```
# amfconfig -T tunable_name=tunable_value,  
tunable_name=tunable_value...
```

Table 23-9 lists the possible tunable parameters for the AMF kernel:

Table 23-9 AMF tunable parameters

AMF parameter	Description	Value
dbglogsz	AMF maintains an in-memory debug log. This parameter (specified in units of KBs) controls the amount of kernel memory allocated for this log.	Min - 4 Max - 512 Default - 256
processhashsz	AMF stores registered events in an event type specific hash table. This parameter controls the number of buckets allocated for the hash table used to store process-related events.	Min - 64 Max - 8192 Default - 2048
mnthashsz	AMF stores registered events in an event type specific hash table. This parameter controls the number of buckets allocated for the hash table used to store mount-related events.	Min - 64 Max - 8192 Default - 512
conthashsz	AMF stores registered events in an event type specific hash table. This parameter controls the number of buckets allocated for the hash table used to store container-related events.	Min - 1 Max - 64 Default - 32
filehashsz	AMF stores registered events in an event type specific hash table. This parameter controls the number of buckets allocated for the hash table used to store file-related events.	Min - 1 Max - 64 Default - 32
dirhashsz	AMF stores registered events in an event type specific hash table. This parameter controls the number of buckets allocated for the hash table used to store directory-related events.	Min - 1 Max - 64 Default - 32

The parameter values that you update are reflected after you reconfigure AMF driver. Note that if you unload the module, the updated values are lost. You must unconfigure the module using the `amfconfig -U` or equivalent command and then reconfigure using the `amfconfig -c` command for the updated tunables to be

effective. If you want to set the tunables at module load time, you can write these `amfconfig` commands in the `amftab` file.

See the `amftab(4)` manual page for details.

Troubleshooting and recovery for VCS

This chapter includes the following topics:

- [VCS message logging](#)
- [Troubleshooting the VCS engine](#)
- [Troubleshooting Low Latency Transport \(LLT\)](#)
- [Troubleshooting Group Membership Services/Atomic Broadcast \(GAB\)](#)
- [Troubleshooting VCS startup](#)
- [Troubleshooting Intelligent Monitoring Framework \(IMF\)](#)
- [Troubleshooting service groups](#)
- [Troubleshooting resources](#)
- [Troubleshooting sites](#)
- [Troubleshooting I/O fencing](#)
- [Troubleshooting notification](#)
- [Troubleshooting and recovery for global clusters](#)
- [Troubleshooting the steward process](#)
- [Troubleshooting licensing](#)
- [Troubleshooting secure configurations](#)
- [Troubleshooting wizard-based configuration issues](#)

- [Troubleshooting issues with the Veritas High Availability view](#)

VCS message logging

VCS generates two types of logs: the engine log and the agent log. Log file names are appended by letters; letter A indicates the first log file, B the second, and C the third. After three files, the least recent file is removed and another file is created. For example, if engine_A.log is filled to its capacity, it is renamed as engine_B.log and the engine_B.log is renamed as engine_C.log. In this example, the least recent file is engine_C.log and therefore it is removed. You can update the size of the log file using the LogSize cluster level attribute.

See “[Cluster attributes](#)” on page 831.

The engine log is located at /var/VRTSvcs/log/engine_A.log. The format of engine log messages is:

Timestamp (Year/MM/DD) | Mnemonic | Severity | UMI | Message Text

- *Timestamp*: the date and time the message was generated.
- *Mnemonic*: the string ID that represents the product (for example, VCS).
- *Severity*: levels include CRITICAL, ERROR, WARNING, NOTICE, and INFO (most to least severe, respectively).
- *UMI*: a unique message ID.
- *Message Text*: the actual message generated by VCS.

A typical engine log resembles:

```
2011/07/10 16:08:09 VCS INFO V-16-1-10077 Received new
cluster membership
```

The agent log is located at /var/VRTSvcs/log/<agent>.log. The format of agent log messages resembles:

Timestamp (Year/MM/DD) | Mnemonic | Severity | UMI | Agent Type | Resource Name | Entry Point | Message Text

A typical agent log resembles:

```
2011/07/10 10:38:23 VCS WARNING V-16-2-23331
Oracle:VRT:monitor:Open for ora_lgwr failed, setting
cookie to null.
```

Note that the logs on all nodes may not be identical because

- VCS logs local events on the local nodes.

- All nodes may not be running when an event occurs.

VCS prints the warning and error messages to STDERR.

If the VCS engine, Command Server, or any of the VCS agents encounter some problem, then First Failure Data Capture (FFDC) logs are generated and dumped along with other core dumps and stack traces to the following location:

- For VCS engine: `$VCS_DIAG/diag/had`
- For Command Server: `$VCS_DIAG/diag/CmdServer`
- For VCS agents: `$VCS_DIAG/diag/agents/type`, where *type* represents the specific agent type.

The default value for variable `$VCS_DIAG` is `/var/VRTSvcs/`.

If the debug logging is not turned on, these FFDC logs are useful to analyze the issues that require professional support.

Log unification of VCS agent's entry points

Earlier, the logs of VCS agents implemented using script and C/C++ language were scattered between the engine log file and agent log file respectively.

The logging is improved so that logs of all the entry points will be logged in respective agent log file. For example, the logs of Mount agent can be found in the Mount agent log file located under `/var/VRTSvcs/log` directory.

Moreover, using `LogViaHalog` attribute, user can switch back to the older logging behavior. This attribute supports two values 0 and 1. By default the value is 0, which means the agent's log will go into their respective agent log file. If value is set to 1, then the C/C++ entry point's logs will go into the agent log file and the script entry point's logs will go into the engine log file using `halog` command.

Note: Irrespective of the value of `LogViaHalog`, the script entry point's logs that are executed in the container will go into the engine log file.

Enhancing First Failure Data Capture (FFDC) to troubleshoot VCS resource's unexpected behavior

FFDC is the process of generating and dumping information on unexpected events.

Earlier, FFDC information is generated on following unexpected events:

- Segmentation fault
- When agent fails to heartbeat with engine

From VCS 6.2 version, the capturing of the FFDC information on unexpected events has been extended to resource level and to cover VCS events. This means, if a resource faces an unexpected behavior then FFDC information will be generated.

The current version enables the agent to log detailed debug logging functions during unexpected events with respect to resource, such as,

- Monitor entry point of a resource reported OFFLINE/INTENTIONAL OFFLINE when it was in ONLINE state.
- Monitor entry point of a resource reported UNKNOWN.
- If any entry point times-out.
- If any entry point reports failure.
- When a resource is detected as ONLINE or OFFLINE for the first time.

Now whenever an unexpected event occurs FFDC information will be automatically generated. And this information will be logged in their respective agent log file.

GAB message logging

If GAB encounters some problem, then First Failure Data Capture (FFDC) logs are also generated and dumped.

When you have configured GAB, GAB also starts a GAB logging daemon (`/opt/VRTSgab/gablogd`). GAB logging daemon is enabled by default. You can change the value of the GAB tunable parameter `gab_ibuf_count` to disable the GAB logging daemon.

See [“About GAB load-time or static tunable parameters”](#) on page 678.

This GAB logging daemon collects the GAB related logs when a critical events such as an iofence or failure of the master of any GAB port occur, and stores the data in a compact binary form. You can use the `gabread_ffdc` utility as follows to read the GAB binary log files:

```
/opt/VRTSgab/gabread_ffdc binary_logs_files_location
```

You can change the values of the following environment variables that control the GAB binary log files:

- `GAB_FFDC_MAX_INDX`: Defines the maximum number of GAB binary log files. The GAB logging daemon collects the defined number of log files each of eight MB size. The default value is 20, and the files are named `gablog.1` through `gablog.20`. At any point in time, the most recent file is the `gablog.1` file.
- `GAB_FFDC_LOGDIR`: Defines the log directory location for GAB binary log files. The default location is:

```
/var/adm/gab_ffdc
```

Note that the gablog daemon writes its log to the `glgd_A.log` and `glgd_B.log` files in the same directory.

You can either define these variables in the following GAB startup file or use the `export` command. You must restart GAB for the changes to take effect.

```
/etc/default/gab
```

Enabling debug logs for agents

This section describes how to enable debug logs for VCS agents.

To enable debug logs for agents

- 1 Set the configuration to read-write:

```
# haconf -makerw
```

- 2 Enable logging and set the desired log levels. Use the following command syntax:

```
# hatype -modify $typename LogDbg DBG_1 DBG_2 DBG_4 DBG_21
```

The following example shows the command line for the IPMultiNIC resource type.

```
# hatype -modify IPMultiNIC LogDbg DBG_1 DBG_2 DBG_4 DBG_21
```

See the description of the `LogDbg` attribute for more information.

See [“Resource type attributes”](#) on page 773.

- 3 For script-based agents, run the `halog` command to add the messages to the engine log:

```
# halog -addtags DBG_1 DBG_2 DBG_4 DBG_21
```

- 4 Save the configuration.

```
# haconf -dump -makero
```

If `DBG_AGDEBUG` is set, the agent framework logs for an instance of the agent appear in the agent log on the node on which the agent is running.

Enabling debug logs for IMF

Run the following commands to enable additional debug logs for Intelligent Monitoring Framework (IMF). The messages get logged in the agent-specific log file `/var/VRTSvcs/log/<agentname>_A.log`.

See [“Troubleshooting Intelligent Monitoring Framework \(IMF\)”](#) on page 710.

To enable additional debug logs

- 1 For Process, Mount, and Application agents:

```
# hatype -modify <agentname> LogDbg
DBG_AGDEBUG DBG_AGTRACE DBG_AGINFO DBG_1 DBG_2
DBG_3 DBG_4 DBG_5 DBG_6 DBG_7
```

- 2 For Oracle and Netlsnr agents:

```
# hatype -modify <agentname> LogDbg
DBG_AGDEBUG DBG_AGTRACE DBG_AGINFO DBG_1 DBG_2
DBG_3 DBG_4 DBG_5 DBG_6 DBG_7
DBG_8 DBG_9 DBG_10
```

- 3 For CFMount agent:

```
# hatype -modify <agentname> LogDbg
DBG_AGDEBUG DBG_AGTRACE DBG_AGINFO DBG_1 DBG_2
DBG_3 DBG_4 DBG_5 DBG_6 DBG_7
DBG_8 DBG_9 DBG_10 DBG_11 DBG_12
DBG_13 DBG_14 DBG_15 DBG_16
DBG_17 DBG_18 DBG_19 DBG_20 DBG_21
```

- 4 For CVMvxconfigd agent, you do not have to enable any additional debug logs.

- 5 For AMF driver in-memory trace buffer:

```
# amfconfig -S errlevel all all
```

If you had enabled AMF driver in-memory trace buffer, you can view the additional logs using the `amfconfig -p dbglog` command.

Enabling debug logs for the VCS engine

You can enable debug logs for the VCS engine, VCS agents, and HA commands in two ways:

- To enable debug logs at run-time, use the `halog -addtags` command.

- To enable debug logs at startup, use the `VCS_DEBUG_LOG_TAGS` environment variable. You must set the `VCS_DEBUG_LOG_TAGS` before you start HAD or before you run HA commands.

See “[VCS environment variables](#)” on page 73.

Examples:

```
# export VCS_DEBUG_LOG_TAGS="DBG_TRACE DBG_POLICY"
# hstart
```

```
# export VCS_DEBUG_LOG_TAGS="DBG_AGINFO DBG_AGDEBUG DBG_AGTRACE"
# hstart
```

```
# export VCS_DEBUG_LOG_TAGS="DBG_IPM"
# hagrps -list
```

Note: Debug log messages are verbose. If you enable debug logs, log files might fill up quickly.

About debug log tags usage

The following table illustrates the use of debug tags:

Entity	Debug logs used
Agent functions	DBG_1 to DBG_21
Agent framework	DBG_AGTRACE DBG_AGDEBUG DBG_AGINFO
Icmp agent	DBG_HBFW_TRACE DBG_HBFW_DEBUG DBG_HBFW_INFO

Entity	Debug logs used
HAD	DBG_AGENT (for agent-related debug logs) DBG_ALERTS (for alert debug logs) DBG_CTEAM (for GCO debug logs) DBG_GAB, DBG_GABIO (for GAB debug messages) DBG_GC (for displaying global counter with each log message) DBG_INTERNAL (for internal messages) DBG_IPM (for Inter Process Messaging) DBG_JOIN (for Join logic) DBG_LIC (for licensing-related messages) DBG_NTEVENT (for NT Event logs) DBG_POLICY (for engine policy) DBG_RSM (for RSM debug messages) DBG_TRACE (for trace messages) DBG_SECURITY (for security-related messages) DBG_LOCK (for debugging lock primitives) DBG_THREAD (for debugging thread primitives) DBG_HOSTMON (for HostMonitor debug logs)

Gathering VCS information for support analysis

You must run the `hagetcf` command to gather information when you encounter issues with VCS. Veritas Technical Support uses the output of these scripts to assist with analyzing and solving any VCS problems. The `hagetcf` command gathers information about the installed software, cluster configuration, systems, logs, and related information and creates a gzip file.

See the `hagetcf(1M)` manual page for more information.

To gather VCS information for support analysis

- ◆ Run the following command on each node:

```
# /opt/VRTSvcs/bin/hagetcf
```

The command prompts you to specify an output directory for the gzip file. You may save the gzip file to either the default `/tmp` directory or a different directory.

Troubleshoot and fix the issue.

See [“Troubleshooting the VCS engine”](#) on page 702.

See [“Troubleshooting VCS startup”](#) on page 709.

See [“Troubleshooting service groups”](#) on page 713.

See [“Troubleshooting resources”](#) on page 719.

See [“Troubleshooting notification”](#) on page 735.

See [“Troubleshooting and recovery for global clusters”](#) on page 735.

See [“Troubleshooting the steward process”](#) on page 739.

If the issue cannot be fixed, then contact Veritas technical support with the file that the `hagetcf` command generates.

Verifying the metered or forecasted values for CPU, Mem, and Swap

This section lists commands for verifying or troubleshooting the metered and forecast data for the parameters metered, such as CPU, Mem, and Swap.

The VCS HostMonitor agent stores metered available capacity values for CPU, Mem, and Swap in absolute values in MHz, MB, and MB units respectively in a respective statlog database. The database files are present in `/opt/VRTSvcs/stats`. The primary database files are `.vcs_host_stats.data` and `.vcs_host_stats.index`. The other files present are used for archival purposes.

The HostMonitor agent uses statlog to get the forecast of available capacity and updates the system attribute `HostAvailableForecast` in the local system.

To gather the data when VCS is running, perform the following steps:

- 1 Stop the HostMonitor agent and restart it after you complete troubleshooting, thus letting you verify the auto-populated value for the system attribute `HostAvailableForecast`.
- 2 Copy the following statlog database files to a different location.
 - `/var/VRTSvcs/stats/.vcs_host_stats.data`
 - `/var/VRTSvcs/stats/.vcs_host_stats.index`

- 3 Save the HostAvailableForecast values for comparison.
- 4 Now you can restart the HostMonitor agent.
- 5 Gather the data as follows:

- To view the metered data, run the following command

```
# /opt/VRTSvcs/bin/vcsstatlog
  --dump /var/VRTSvcs/stats/copied_vcs_host_stats
```

- To get the forecasted available capacity for CPU, Mem, and Swap for a system in cluster, run the following command on the system on which you copied the statlog database:

```
# /opt/VRTSvcs/bin/vcsstatlog --shell --load \
/var/VRTSvcs/stats/copied_vcs_host_stats --names CPU --holts \
--npred 1 --csv
# /opt/VRTSvcs/bin/vcsstatlog --shell --load \
/var/VRTSvcs/stats/copied_vcs_host_stats --names Mem --holts \
--npred 1 --csv
# /opt/VRTSvcs/bin/vcsstatlog --shell --load \
/var/VRTSvcs/stats/copied_vcs_host_stats --names Swap --holts \
--npred 1 --csv
```

Gathering LLT and GAB information for support analysis

You must run the `getcomms` script to gather LLT and GAB information when you encounter issues with LLT and GAB. The `getcomms` script also collects core dump and stack traces along with the LLT and GAB information.

To gather LLT and GAB information for support analysis

- 1 If you had changed the default value of the `GAB_FFDC_LOGDIR` parameter, you must again export the same variable before you run the `getcomms` script.

See [“GAB message logging”](#) on page 693.

- 2 Run the following command to gather information:

```
# /opt/VRTSgab/getcomms
```

The script uses `rsh` by default. Make sure that you have configured passwordless `rsh`. If you have passwordless `ssh` between the cluster nodes, you can use the `-ssh` option. To gather information on the node that you run the command, use the `-local` option.

Troubleshoot and fix the issue.

See [“Troubleshooting Low Latency Transport \(LLT\)”](#) on page 704.

See [“Troubleshooting Group Membership Services/Atomic Broadcast \(GAB\)”](#) on page 707.

If the issue cannot be fixed, then contact Veritas technical support with the file `/tmp/commslog.<time_stamp>.tar` that the `getcomms` script generates.

Gathering IMF information for support analysis

You must run the `getimf` script to gather information when you encounter issues with IMF (Intelligent Monitoring Framework).

To gather IMF information for support analysis

- ◆ Run the following command on each node:

```
# /opt/VRTSamf/bin/getimf
```

Troubleshoot and fix the issue.

See [“Troubleshooting Intelligent Monitoring Framework \(IMF\)”](#) on page 710.

If the issue cannot be fixed, then contact Veritas technical support with the file that the `getimf` script generates.

Message catalogs

VCS includes multilingual support for message catalogs. These binary message catalogs (BMCs), are stored in the following default locations. The variable *language* represents a two-letter abbreviation.

```
/opt/VRTS/messages/language/module_name
```

The VCS command-line interface displays error and success messages in VCS-supported languages. The `hamsmsg` command displays the VCS engine logs in VCS-supported languages.

The BMCs are:

<code>amf.bmc</code>	Asynchronous Monitoring Framework (AMF) messages
<code>fdsetup.bmc</code>	fdsetup messages
<code>gab.bmc</code>	GAB command-line interface messages
<code>gcoconfig.bmc</code>	gcoconfig messages
<code>hagetcf.bmc</code>	hagetcf messages
<code>hagui.bmc</code>	hagui messages
<code>haimfconfig.bmc</code>	haimfconfig messages
<code>hazonesetup.bmc</code>	hazonesetup messages
<code>hazoneverify.bmc</code>	hazoneverify messages
<code>llt.bmc</code>	LLT command-line interface messages
<code>uuidconfig.bmc</code>	uuidconfig messages
<code>VRTSvcsAgfw.bmc</code>	Agent framework messages
<code>VRTSvcsAlerts.bmc</code>	VCS alert messages
<code>VRTSvcsApi.bmc</code>	VCS API messages
<code>VRTSvcsce.bmc</code>	VCS cluster extender messages
<code>VRTSvcsCommon.bmc</code>	Common module messages
<code>VRTSvcs<platform>Agent.bmc</code>	VCS bundled agent messages
<code>VRTSvcsHad.bmc</code>	VCS engine (HAD) messages
<code>VRTSvcsHbfb.bmc</code>	Heartbeat framework messages
<code>VRTSvcsNetUtils.bmc</code>	VCS network utilities messages
<code>VRTSvcs<platformagent_name>.bmc</code>	VCS enterprise agent messages
<code>VRTSvcsTriggers.bmc</code>	VCS trigger messages
<code>VRTSvcsVirtUtils.bmc</code>	VCS virtualization utilities messages
<code>VRTSvcsWac.bmc</code>	Wide-area connector process messages

vxfen*.bmc

Fencing messages

Troubleshooting the VCS engine

This topic includes information on troubleshooting the VCS engine.

See [“Preonline IP check”](#) on page 703.

HAD diagnostics

When the VCS engine HAD dumps core, the core is written to the directory `$VCS_DIAG/diag/had`. The default value for variable `$VCS_DIAG` is `/var/VRTSvcs/`.

When HAD core dumps, review the contents of the `$VCS_DIAG/diag/had` directory. See the following logs for more information:

- Operating system console log
- Engine log
- hashadow log

VCS runs the script `/opt/VRTSvcs/bin/vcs_diag` to collect diagnostic information when HAD and GAB encounter heartbeat problems. The diagnostic information is stored in the `$VCS_DIAG/diag/had` directory.

When HAD starts, it renames the directory to `had.timestamp`, where *timestamp* represents the time at which the directory was renamed.

HAD restarts continuously

When you start HAD by using the `hastart` command, HAD might restart continuously. The system is unable to come to a RUNNING state and loses its port `h` membership.

Recommended action: Check the `engine_A.log` file for a message with the identifier V-16-1-10125. The following message is an example:

```
VCS INFO V-16-1-10125 GAB timeout set to 30000 ms
```

The value indicates the timeout that is set for HAD to heartbeat with GAB. If system is heavily loaded, a timeout of 30 seconds might be insufficient for HAD to heartbeat with GAB. If required, set the timeout to an appropriate higher value.

DNS configuration issues cause GAB to kill HAD

If HAD is periodically killed by GAB for no apparent reason, review the HAD core files for any DNS resolver functions (`res_send()`, `res_query()`, `res_search()` etc) in the stack trace. The presence of DNS resolver functions may indicate DNS configuration issues.

The VCS High Availability Daemon (HAD) uses the `gethostbyname()` function. On UNIX platforms, if the file `/etc/nsswitch.conf` has DNS in the hosts entry, a call to the `gethostbyname()` function may lead to calls to DNS resolver methods.

If the name servers specified in the `/etc/resolve.conf` are not reachable or if there are any DNS configuration issues, the DNS resolver methods called may block HAD, leading to HAD not sending heartbeats to GAB in a timely manner.

Seeding and I/O fencing

When I/O fencing starts up, a check is done to make sure the systems that have keys on the coordinator points are also in the GAB membership. If the `gabconfig` command in `/etc/gabtab` allows the cluster to seed with less than the full number of systems in the cluster, or the cluster is forced to seed with the `gabconfig -x` command, it is likely that this check will not match. In this case, the fencing module will detect a possible split-brain condition, print an error, and HAD will not start.

It is recommended to let the cluster automatically seed when all members of the cluster can exchange heartbeat signals to each other. In this case, all systems perform the I/O fencing key placement after they are already in the GAB membership.

Preonline IP check

You can enable a preonline check of a failover IP address to protect against network partitioning. The check pings a service group's configured IP address to verify that it is not already in use. If it is, the service group is not brought online.

A second check verifies that the system is connected to its public network and private network. If the system receives no response from a broadcast ping to the public network and a check of the private networks, it determines the system is isolated and does not bring the service group online.

To enable the preonline IP check, do one of the following:

- If preonline trigger script is not already present, copy the preonline trigger script from the sample triggers directory into the triggers directory:

```
# cp /opt/VRTSvcs/bin/sample_triggers/VRTSvcs/preonline_ipc
/opt/VRTSvcs/bin/triggers/preonline
```

Change the file permissions to make it executable.

- If preonline trigger script is already present, create a directory such as `/preonline` and move the existing preonline trigger as `T0preonline` to that directory. Copy the preonline_ipc trigger as `T1preonline` to the same directory.
- If you already use multiple triggers, copy the preonline_ipc trigger as `TNpreonline`, where `TN` is the next higher `TNumber`.

Troubleshooting Low Latency Transport (LLT)

This section includes error messages associated with Low Latency Transport (LLT) and provides descriptions and the recommended action.

LLT startup script displays errors

If more than one system on the network has the same clusterid-nodeid pair and the same Ethernet sap/UDP port, then the LLT startup script displays error messages similar to the following:

```
LLT lltconfig ERROR V-14-2-15238 node 1 already exists
in cluster 8383 and has the address - 00:18:8B:E4:DE:27
LLT lltconfig ERROR V-14-2-15241 LLT not configured,
use -o to override this warning
LLT lltconfig ERROR V-14-2-15664 LLT could not
configure any link
LLT lltconfig ERROR V-14-2-15245 cluster id 1 is
already being used by nid 0 and has the
address - 00:04:23:AC:24:2D
LLT lltconfig ERROR V-14-2-15664 LLT could not
configure any link
```

Recommended action: Ensure that all systems on the network have unique clusterid-nodeid pair. You can use the `lltdump -f device -D` command to get the list of unique clusterid-nodeid pairs connected to the network. This utility is available only for LLT-over-ethernet.

LLT detects cross links usage

If LLT detects more than one link of a system that is connected to the same network, then LLT logs a warning message similar to the following in the `/var/adm/streams/error.date` log:

LLT WARNING V-14-1-10498 recvarpack cross links? links 0 and 2 saw the same peer link number 1 for node 1

Recommended Action: This is an informational message. LLT supports cross links. However, if this cross links is not an intentional network setup, then make sure that no two links from the same system go to the same network. That is, the LLT links need to be on separate networks.

LLT link status messages

[Table 24-1](#) describes the LLT logs messages such as trouble, active, inactive, or expired in the syslog for the links.

Table 24-1 LLT link status messages

Message	Description and Recommended action
<pre>LLT INFO V-14-1-10205 link 1 (<i>link_name</i>) node 1 in trouble</pre>	<p>This message implies that LLT did not receive any heartbeats on the indicated link from the indicated peer node for LLT peertrouble time. The default LLT peertrouble time is 2s for hipri links and 4s for lopri links.</p> <p>Recommended action: If these messages sporadically appear in the syslog, you can ignore them. If these messages flood the syslog, then perform one of the following:</p> <ul style="list-style-type: none"> <p>Increase the peertrouble time to a higher value (but significantly lower than the peerinact value). Run the following command:</p> <pre>lltconfig -T peertrouble:<value> for hipri link lltconfig -T peertroublelo:<value> for lopri links.</pre> <p>See the <code>lltconfig(1m)</code> manual page for details.</p> <p>Replace the LLT link. See "Adding and removing LLT links" on page 182.</p>
<pre>LLT INFO V-14-1-10024 link 0 (<i>link_name</i>) node 1 active</pre>	<p>This message implies that LLT started seeing heartbeats on this link from that node.</p> <p>Recommended action: No action is required. This message is informational.</p>

Table 24-1 LLT link status messages (*continued*)

Message	Description and Recommended action
<pre>LLT INFO V-14-1-10032 link 1 (<i>link_name</i>) node 1 inactive 5 sec (510)</pre>	<p>This message implies that LLT did not receive any heartbeats on the indicated link from the indicated peer node for the indicated amount of time.</p> <p>If the peer node has not actually gone down, check for the following:</p> <ul style="list-style-type: none"> ■ Check if the link has got physically disconnected from the system or switch. ■ Check for the link health and replace the link if necessary. <p>See “Adding and removing LLT links” on page 182.</p>
<pre>LLT INFO V-14-1-10510 sent hbreq (NULL) on link 1 (<i>link_name</i>) node 1. 4 more to go. LLT INFO V-14-1-10510 sent hbreq (NULL) on link 1 (<i>link_name</i>) node 1. 3 more to go. LLT INFO V-14-1-10510 sent hbreq (NULL) on link 1 (<i>link_name</i>) node 1. 2 more to go. LLT INFO V-14-1-10032 link 1 (<i>link_name</i>) node 1 inactive 6 sec (510) LLT INFO V-14-1-10510 sent hbreq (NULL) on link 1 (<i>link_name</i>) node 1. 1 more to go. LLT INFO V-14-1-10510 sent hbreq (NULL) on link 1 (<i>link_name</i>) node 1. 0 more to go. LLT INFO V-14-1-10032 link 1 (<i>link_name</i>) node 1 inactive 7 sec (510) LLT INFO V-14-1-10509 link 1 (<i>link_name</i>) node 1 expired</pre>	<p>This message implies that LLT did not receive any heartbeats on the indicated link from the indicated peer node for more than LLT peerinact time. LLT attempts to request heartbeats (sends 5 hbreqs to the peer node) and if the peer node does not respond, LLT marks this link as “expired” for that peer node.</p> <p>Recommended action: If the peer node has not actually gone down, check for the following:</p> <ul style="list-style-type: none"> ■ Check if the link has got physically disconnected from the system or switch. ■ Check for the link health and replace the link if necessary. <p>See “Adding and removing LLT links” on page 182.</p>
<pre>LLT INFO V-14-1-10499 recvarpreq link 0 for node 1 addr change from 00:00:00:00:00:00 to 00:18:8B:E4:DE:27</pre>	<p>This message is logged when LLT learns the peer node's address.</p> <p>Recommended action: No action is required. This message is informational.</p>

Table 24-1 LLT link status messages (*continued*)

Message	Description and Recommended action
<p>On local node that detects the link failure:</p> <pre>LLT INFO V-14-1-10519 link 0 down LLT INFO V-14-1-10585 local link 0 down for 1 sec LLT INFO V-14-1-10586 send linkdown_ntf on link 1 for local link 0 LLT INFO V-14-1-10590 recv linkdown_ack from node 1 on link 1 for local link 0 LLT INFO V-14-1-10592 received ack from all the connected nodes</pre> <p>On peer nodes:</p> <pre>LLT INFO V-14-1-10589 recv linkdown_ntf from node 0 on link 1 for peer link 0 LLT INFO V-14-1-10587 send linkdown_ack to node 0 on link 1 for peer link 0</pre>	<p>These messages are printed when you have enabled LLT to detect faster failure of links. When a link fails or is disconnected from a node (cable pull, switch failure, and so on), LLT on the local node detects this event and propagates this information to all the peer nodes over the LLT hidden link. LLT marks this link as disconnected when LLT on the local node receives the acknowledgment from all the nodes.</p>

Troubleshooting Group Membership Services/Atomic Broadcast (GAB)

This section includes error messages associated with Group Membership Services/Atomic Broadcast (GAB) and provides descriptions and the recommended action.

GAB timer issues

GAB timer only wakes up a thread that does the real work. If either the operating system did not get a chance to schedule the thread or the operating system did not fire the timer itself, then GAB might log a message similar to the following:

```
GAB INFO V-15-1-20124 timer not called for 11 seconds
```

Recommended Action: If this issue occurs rarely at times of high load, and does not cause any detrimental effects, the issue is benign. If the issue recurs, or if the issue causes repeated VCS daemon restarts or node panics, you must increase the priority of the thread (`gab_timer_pri` tunable parameter).

See [“About GAB load-time or static tunable parameters”](#) on page 678.

If problem persists, collect the following and contact Veritas support:

- sar or perfmgr data
- Any VCS daemon diagnostics
- Any panic dumps
- commslog on all nodes

Delay in port reopen

If a GAB port was closed and reopened before LLT state cleanup action is completed, then GAB logs a message similar to the following:

```
GAB INFO V-15-1-20102 Port v: delayed reopen
```

Recommended Action: If this issue occurs during a GAB reconfiguration, and does not recur, the issue is benign. If the issue persists, collect commslog from each node, and contact Veritas support.

Node panics due to client process failure

If VCS daemon does not heartbeat with GAB within the configured timeout specified in VCS_GAB_TIMEOUT (default 30sec) environment variable, the node panics with a message similar to the following:

```
GAB Port h halting node due to client process failure at 3:109
```

GABs attempt (five retries) to kill the VCS daemon fails if VCS daemon is stuck in the kernel in an uninterruptible state or the system is heavily loaded that the VCS daemon cannot die with a SIGKILL.

Recommended Action:

- In case of performance issues, increase the value of the VCS_GAB_TIMEOUT environment variable to allow VCS more time to heartbeat.
See [“VCS environment variables”](#) on page 73.
- In case of a kernel problem, configure GAB to not panic but continue to attempt killing the VCS daemon.

Do the following:

- Run the following command on each node:

```
gabconfig -k
```

- Add the “-k” option to the gabconfig command in the `/etc/gabtab` file:

```
gabconfig -c -k -n 6
```

- In case the problem persists, collect sar or similar output, collect crash dumps, run the Veritas Operations and Readiness Tools (SORT) data collector on all nodes, and contact Veritas Technical Support.

Troubleshooting VCS startup

This topic includes error messages associated with starting VCS (shown in bold text), and provides descriptions of each error and the recommended action.

"VCS:10622 local configuration missing"

The local configuration is missing.

Recommended Action: Start the VCS engine, HAD, on another system that has a valid configuration file. The system with the configuration error pulls the valid configuration from the other system.

Another method is to install the configuration file on the local system and force VCS to reread the configuration file. If the file appears valid, verify that is not an earlier version.

Type the following commands to verify the configuration:

```
# cd /etc/VRTSvcs/conf/config  
# hacf -verify .
```

"VCS:10623 local configuration invalid"

The local configuration is invalid.

Recommended Action: Start the VCS engine, HAD, on another system that has a valid configuration file. The system with the configuration error "pulls" the valid configuration from the other system.

Another method is to correct the configuration file on the local system and force VCS to re-read the configuration file. If the file appears valid, verify that is not an earlier version.

Type the following commands to verify the configuration:

```
# cd /etc/VRTSvcs/conf/config  
# hacf -verify .
```

"VCS:11032 registration failed. Exiting"

GAB was not registered or has become unregistered.

Recommended Action: GAB is registered by the `gabconfig` command in the file `/etc/gabtab`. Verify that the file exists and that it contains the command `gabconfig -c`.

GAB can become unregistered if LLT is set up incorrectly. Verify that the configuration is correct in `/etc/llttab`. If the LLT configuration is incorrect, make the appropriate changes and reboot.

"Waiting for cluster membership."

This indicates that GAB may not be seeded. If this is the case, the command `gabconfig -a` does not show any members, and the following messages may appear on the console or in the event log.

```
GAB: Port a registration waiting for seed port membership
GAB: Port h registration waiting for seed port membership
```

Troubleshooting Intelligent Monitoring Framework (IMF)

Review the following logs to isolate and troubleshoot Intelligent Monitoring Framework (IMF) related issues:

- System console log for the given operating system
- VCS engine Log : `/var/VRTSvcs/log/engine_A.log`
- Agent specific log : `/var/VRTSvcs/log/<agentname>_A.log`
- AMF in-memory trace buffer : View the contents using the `amfconfig -p dbglog` command

See [“Enabling debug logs for IMF”](#) on page 695.

See [“Gathering IMF information for support analysis”](#) on page 700.

[Table 24-2](#) lists the most common issues for intelligent resource monitoring and provides instructions to troubleshoot and fix the issues.

Table 24-2 IMF-related issues and recommended actions

Issue	Description and recommended action
<p>Intelligent resource monitoring has not reduced system utilization</p>	<p>If the system is busy even after intelligent resource monitoring is enabled, troubleshoot as follows:</p> <ul style="list-style-type: none"> ■ Check the agent log file to see whether the <code>imf_init</code> agent function has failed. <p>If the <code>imf_init</code> agent function has failed, then do the following:</p> <ul style="list-style-type: none"> ■ Make sure that the <code>AMF_START</code> environment variable value is set to 1. See “Environment variables to start and stop VCS modules” on page 78. ■ Make sure that the AMF module is loaded. See “Administering the AMF kernel driver” on page 186. <ul style="list-style-type: none"> ■ Make sure that the IMF attribute values are set correctly for the following attribute keys: <ul style="list-style-type: none"> ■ The value of the Mode key of the IMF attribute must be set to 1, 2, or 3. ■ The value of the MonitorFreq key of the IMF attribute must be set to either 0 or a value greater than 0. <p>For example, the value of the MonitorFreq key can be set to 0 for the Process agent. Refer to the appropriate agent documentation for configuration recommendations corresponding to the IMF-aware agent.</p> <p>Note that the IMF attribute can be overridden. So, if the attribute is set for individual resource, then check the value for individual resource.</p> <p>See “Resource type attributes” on page 773.</p> <ul style="list-style-type: none"> ■ Verify that the resources are registered with the AMF driver. Check the <code>amfstat</code> command output. ■ Check the LevelTwoMonitorFreq attribute settings for the agent. For example, Process agent must have this attribute value set to 0. Refer to the appropriate agent documentation for configuration recommendations corresponding to the IMF-aware agent.
<p>Enabling the agent's intelligent monitoring does not provide immediate performance results</p>	<p>The actual intelligent monitoring for a resource starts only after a steady state is achieved. So, it takes some time before you can see positive performance effect after you enable IMF. This behavior is expected.</p> <p>For more information on when a steady state is reached, see the following topic: See “How intelligent resource monitoring works” on page 42.</p>

Table 24-2 IMF-related issues and recommended actions (*continued*)

Issue	Description and recommended action
<p>Agent does not perform intelligent monitoring despite setting the IMF mode to 3</p>	<p>For the agents that use AMF driver for IMF notification, if intelligent resource monitoring has not taken effect, do the following:</p> <ul style="list-style-type: none"> ■ Make sure that IMF attribute's Mode key value is set to three (3). See "Resource type attributes" on page 773. ■ Review the the agent log to confirm that <code>imf_init()</code> agent registration with AMF has succeeded. AMF driver must be loaded before the agent starts because the agent registers with AMF at the agent startup time. If this was not the case, start the AMF module and restart the agent. See "Administering the AMF kernel driver" on page 186.
<p>AMF module fails to unload despite changing the IMF mode to 0</p>	<p>Even after you change the value of the Mode key to zero, the agent still continues to have a hold on the AMF driver until you kill the agent. To unload the AMF module, all holds on it must get released.</p> <p>If the AMF module fails to unload after changing the IMF mode value to zero, do the following:</p> <ul style="list-style-type: none"> ■ Run the <code>amfconfig -Uof</code> command. This command forcefully removes all holds on the module and unconfigures it. ■ Then, unload AMF. See "Administering the AMF kernel driver" on page 186.
<p>When you try to enable IMF for an agent, the <code>haimfconfig -enable -agent <agent_name></code> command returns a message that IMF is enabled for the agent. However, when VCS and the respective agent is running, the <code>haimfconfig -display</code> command shows the status for <code>agent_name</code> as DISABLED.</p>	<p>A few possible reasons for this behavior are as follows:</p> <ul style="list-style-type: none"> ■ The agent might require some manual steps to make it IMF-aware. Refer to the agent documentation for these manual steps. ■ The agent is a custom agent and is not IMF-aware. For information on how to make a custom agent IMF-aware, see the <i>Cluster Server Agent Developer's Guide</i>. ■ If the preceding steps do not resolve the issue, contact Veritas technical support.

Troubleshooting service groups

This topic cites the most common problems associated with bringing service groups online and taking them offline. Bold text provides a description of the problem. Recommended action is also included, where applicable.

VCS does not automatically start service group

VCS does not automatically start a failover service group if the VCS engine (HAD) in the cluster was restarted by the hashadow process.

This behavior prevents service groups from coming online automatically due to events such as GAB killing HAD because to high load, or HAD committing suicide to rectify unexpected error conditions.

System is not in RUNNING state

Recommended Action: Type `hasys -display system` to check the system status. When the system is not in running state, we may start VCS if there are no issues found.

Service group not configured to run on the system

The SystemList attribute of the group may not contain the name of the system.

Recommended Action: Use the output of the command `hagrp -display service_group` to verify the system name.

Service group not configured to autostart

If the service group is not starting automatically on the system, the group may not be configured to AutoStart, or may not be configured to AutoStart on that particular system.

Recommended Action: Use the output of the command `hagrp -display service_group AutoStartList node_list` to verify the values of the AutoStart and AutoStartList attributes.

Service group is frozen

Recommended Action: Use the output of the command `hagrp -display service_group` to verify the value of the Frozen and TFrozen attributes. Use the command `hagrp -unfreeze` to unfreeze the group. Note that VCS will not take a frozen service group offline.

Failover service group is online on another system

The group is a failover group and is online or partially online on another system.

Recommended Action: Use the output of the command `hagrp -display service_group` to verify the value of the State attribute. Use the command `hagrp -offline` to offline the group on another system.

A critical resource faulted

Output of the command `hagrp -display service_group` indicates that the service group has faulted.

Recommended Action: Use the command `hares -clear` to clear the fault.

Service group autodisabled

When VCS does not know the status of a service group on a particular system, it autodisables the service group on that system. Autodisabling occurs under the following conditions:

- When the VCS engine, HAD, is not running on the system.
 Under these conditions, all service groups that include the system in their SystemList attribute are autodisabled. This does not apply to systems that are powered off.
- When all resources within the service group are not probed on the system.

Recommended Action: Use the output of the command `hagrp -display service_group` to verify the value of the AutoDisabled attribute.

Warning: To bring a group online manually after VCS has autodisabled the group, make sure that the group is not fully or partially active on any system that has the AutoDisabled attribute set to 1 by VCS. Specifically, verify that all resources that may be corrupted by being active on multiple systems are brought down on the designated systems. Then, clear the AutoDisabled attribute for each system: `# hagrp -autoenable service_group -sys system`

Service group is waiting for the resource to be brought online/taken offline

Recommended Action: Review the IState attribute of all resources in the service group to locate which resource is waiting to go online (or which is waiting to be taken offline). Use the `hastatus` command to help identify the resource. See the

engine and agent logs in `/var/VRTSvcs/log` for information on why the resource is unable to be brought online or be taken offline.

To clear this state, make sure all resources waiting to go online/offline do not bring themselves online/offline. Use the `hagrp -flush` command or the `hagrp -flush -force` command to clear the internal state of VCS. You can then bring the service group online or take it offline on another system.

For more information on the `hagrp -flush` and `hagrp -flush -force` commands.

Warning: Exercise caution when you use the `-force` option. It can lead to situations where a resource status is unintentionally returned as `FAULTED`. In the time interval that a resource transitions from 'waiting to go offline' to 'not waiting', if the agent has not completed the offline agent function, the agent may return the state of the resource as `OFFLINE`. VCS considers such unexpected offline of the resource as `FAULT` and starts recovery action that was not intended.

Service group is waiting for a dependency to be met.

Recommended Action: To see which dependencies have not been met, type `hagrp -dep service_group` to view service group dependencies, or `hares -dep resource` to view resource dependencies.

Service group not fully probed.

This occurs if the agent processes have not monitored each resource in the service group. When the VCS engine, HAD, starts, it immediately "probes" to find the initial state of all of resources. (It cannot probe if the agent is not returning a value.) A service group must be probed on all systems included in the `SystemList` attribute before VCS attempts to bring the group online as part of `AutoStart`. This ensures that even if the service group was online prior to VCS being brought up, VCS will not inadvertently bring the service group online on another system.

Recommended Action: Use the output of `hagrp -display service_group` to see the value of the `ProbesPending` attribute for the system's service group. The value of the `ProbesPending` attribute corresponds to the number of resources which are not probed, and it should be zero when all resources are probed. To determine which resources are not probed, verify the local "Probed" attribute for each resource on the specified system. Zero means waiting for probe result, 1 means probed, and 2 means VCS not booted. See the engine and agent logs for information.

Service group does not fail over to the forecasted system

This behaviour is expected when other events occur between the time the `hagrp -forecast` command was executed and the time when the service group or system actually fail over or switch over. VCS might select a system which is different than one mentioned in the `hagrp -forecast` command.

VCS logs detailed messages in the engine log, including the reason for selecting a specific node as a target node over other possible target nodes.

Service group does not fail over to the BiggestAvailable system even if FailOverPolicy is set to BiggestAvailable

Sometimes, a service group might not fail over to the biggest available system even when FailOverPolicy is set to BiggestAvailable.

To troubleshoot this issue, check the engine log located in `/var/VRTSvcs/log/engine_A.log` to find out the reasons for not failing over to the biggest available system. This may be due to the following reasons:

- If , one or more of the systems in the service group's SystemList did not have forecasted available capacity, you see the following message in the engine log:
One of the systems in SystemList of group group_name, system system_name does not have forecasted available capacity updated
- If the `hautil -sys` command does not list forecasted available capacity for the systems, you see the following message in the engine log:
Failed to forecast due to insufficient data
 This message is displayed due to insufficient recent data to be used for forecasting the available capacity.
 The default value for the MeterInterval key of the cluster attribute MeterControl is 120 seconds. There will be enough recent data available for forecasting after 3 metering intervals (6 minutes) from time the VCS engine was started on the system. After this, the forecasted values are updated every ForecastCycle * MeterInterval seconds. The ForecastCycle and MeterInterval values are specified in the cluster attribute MeterControl.
- If one or more of the systems in the service group's SystemList have stale forecasted available capacity, you can see the following message in the engine log:
System system_name has not updated forecasted available capacity since last 2 forecast cycles
 This issue is caused when the HostMonitor agent stops functioning. Check if HostMonitor agent process is running by issuing one of the following commands on the system which has stale forecasted values:

- # ps -aef|grep HostMonitor
- # haagent -display HostMonitor

If HostMonitor agent is not running, you can start it by issuing the following command:

```
# haagent -start HostMonitor -sys system_name
```

Even if HostMonitor agent is running and you see the above message in the engine log, it means that the HostMonitor agent is not able to forecast, and it will log error messages in the HostMonitor_A.log file in the /var/VRTSvcs/log/ directory.

Restoring metering database from backup taken by VCS

When VCS detects that the metering database has been corrupted or has been accidentally deleted outside VCS, it creates a backup of the database. The data available in memory is backed up and a message is logged, and administrative intervention is required to restore the database and reinstate metering and forecast.

The following log message will appear in the engine log:

```
The backup of metering database from in-memory data is created and saved in <path for metering database backup>. Administrative intervention required to use the backup database.
```

To restore the database for metering and forecast functionality

- 1 Stop the HostMonitor agent using the following command:

```
# /opt/VRTSvcs/bin/haagent -stop HostMonitor -force -sys system name
```

- 2 Delete the database if it exists.

```
# rm /var/VRTSvcs/stats/.vcs_host_stats.data \  
/var/VRTSvcs/stats/.vcs_host_stats.index
```

- 3 Restore metering database from the backup.

```
# cp /var/VRTSvcs/stats/.vcs_host_stats_bkup.data \  
/var/VRTSvcs/stats/.vcs_host_stats.data
```

```
# cp /var/VRTSvcs/stats/.vcs_host_stats_bkup.index \  
/var/VRTSvcs/stats/.vcs_host_stats.index
```

4 Setup the database.

```
# /opt/VRTSvcs/bin/vcsstatlog --setprop \  
/var/VRTSvcs/stats/.vcs_host_stats rate 120  
  
# /opt/VRTSvcs/bin/vcsstatlog --setprop \  
/var/VRTSvcs/stats/.vcs_host_stats compresssto \  
/var/VRTSvcs/stats/.vcs_host_stats_daily  
  
# /opt/VRTSvcs/bin/vcsstatlog --setprop \  
/var/VRTSvcs/stats/.vcs_host_stats compressmode avg  
  
# /opt/VRTSvcs/bin/vcsstatlog --setprop \  
/var/VRTSvcs/stats/.vcs_host_stats compressfreq 24h
```

5 Start the HostMonitor agent.

```
# /opt/VRTSvcs/bin/haagent -start HostMonitor -sys system name
```

Initialization of metering database fails

The metering database can fail to initialize if there is an existing corrupt database. In this case, VCS cannot open and initialize the database.

The following log message will appear in the engine log:

```
Initialization of database to save metered data failed and will not  
be able to get forecast. Error corrupt statlog database, error  
code=19, errno=0
```

To restore the metering and forecast functionality,

1 Stop the HostMonitor agent using the following command

```
# /opt/VRTSvcs/bin/haagent -stop HostMonitor -force -sys system name
```

2 Delete the metering database.

```
# rm /var/VRTSvcs/stats/.vcs_host_stats.data \  
/var/VRTSvcs/stats/.vcs_host_stats.index
```

3 Start the HostMonitor agent.

```
# /opt/VRTSvcs/bin/haagent -start HostMonitor -sys system name
```

Error message appears during service group failover or switch

During a service group failover or switch, if the system tries to unreserve more than the reserved capacity, the following error message appears:

```
VCS ERROR V-16-1-56034 ReservedCapacity for attribute dropped below zero for
system sys1 when unreserving for group service_group; setting to zero.
```

This error message appears only if the service group's load requirements change during the transition period.

Recommended Action: No action is required. You can ignore this message.

Troubleshooting resources

This topic cites the most common problems associated with bringing resources online and taking them offline. Bold text provides a description of the problem. Recommended action is also included, where applicable.

Service group brought online due to failover

VCS attempts to bring resources online that were already online on the failed system, or were in the process of going online. Each parent resource must wait for its child resources to be brought online before starting.

Recommended Action: Verify that the child resources are online.

Waiting for service group states

The state of the service group prevents VCS from bringing the resource online.

Recommended Action: Review the state of the service group.

Waiting for child resources

One or more child resources of parent resource are offline.

Recommended Action: Bring the child resources online first.

Waiting for parent resources

One or more parent resources are online.

Recommended Action: Take the parent resources offline first.

See [“Troubleshooting resources”](#) on page 719.

Waiting for resource to respond

The resource is waiting to come online or go offline, as indicated. VCS directed the agent to run an online entry point for the resource.

Recommended Action: Verify the resource's IState attribute. See the engine and agent logs in `/var/VRTSvcs/engine_A.log` and `/var/VRTSvcs/agent_A.log` for information on why the resource cannot be brought online.

Agent not running

The resource's agent process is not running.

Recommended Action: Use `hastatus -summary` to see if the agent is listed as faulted. Restart the agent:

```
# haagent -start resource_type -sys system
```

Invalid agent argument list.

The scripts are receiving incorrect arguments.

Recommended Action: Verify that the arguments to the scripts are correct. Use the output of `hares -display resource` to see the value of the ArgListValues attribute. If the ArgList attribute was dynamically changed, stop the agent and restart it.

To stop the agent:

```
◆ # haagent -stop resource_type -sys system
```

To restart the agent

```
◆ # haagent -start resource_type -sys system
```

The Monitor entry point of the disk group agent returns ONLINE even if the disk group is disabled

This is expected agent behavior. VCS assumes that data is being read from or written to the volumes and does not declare the resource as offline. This prevents potential data corruption that could be caused by the disk group being imported on two hosts.

You can deport a disabled disk group when all I/O operations are completed or when all volumes are closed. You can then reimport the disk group to the same system. Reimporting a disabled disk group may require a system reboot.

Note: A disk group is disabled if data including the kernel log, configuration copies, or headers in the private region of a significant number of disks is invalid or inaccessible. Volumes can perform read-write operations if no changes are required to the private regions of the disks.

Troubleshooting sites

The following sections discuss troubleshooting the sites. Bold text provides a description of the problem. Recommended action is also included, where applicable.

Online propagate operation was initiated but service group failed to be online

Recommended Action: Check the State and PolicyIntention attributes for the parent and child service groups using the command:

```
<hagr -display -attribute State PolicyIntention -all>
```

And check for errors in the engine log.

VCS panics nodes in the preferred site during a network-split

Recommended Action:

- Check the node weights using the command `<vxfenconfig -a>`. Nodes in the high preference site should have higher weight than nodes in the medium or low preference sites.
- If the node weights are not set, then check the cluster attributes UseFence and PreferredFencingPolicy.
- Check the engine log for errors.
- If the node weights are correct, then check the fencing logs for more details.

Configuring of stretch site fails

Recommended Action:

- For Campus Cluster, in a non-CVM configuration, check if DiskGroup is imported at least once on all nodes.
 Disk group should be listed in `server-> <hostname> -> Disk Groups`, and imported on one node and also should be in the deported state on other nodes of cluster.

- If Disk Group is not appearing in the *server-> <Hostname> -> Disk Groups*, then right click on *<Hostname>* and run **Rescan Disks**.
- For Campus cluster, tag all enclosures whose disks are part of Disk Groups used for campus cluster setup

Renaming a Site

Recommended Action: For renaming the site, re-run the Stretch Cluster Configuration flow by changing the Site names

Troubleshooting I/O fencing

The following sections discuss troubleshooting the I/O fencing problems. Review the symptoms and recommended solutions.

Node is unable to join cluster while another node is being ejected

A cluster that is currently fencing out (ejecting) a node from the cluster prevents a new node from joining the cluster until the fencing operation is completed. The following are example messages that appear on the console for the new node:

```
...VxFEN ERROR V-11-1-25 ... Unable to join running cluster
since cluster is currently fencing
a node out of the cluster.
```

If you see these messages when the new node is booting, the vxfen startup script on the node makes up to five attempts to join the cluster.

To manually join the node to the cluster when I/O fencing attempts fail

- ◆ If the vxfen script fails in the attempts to allow the node to join the cluster, restart vxfen driver with the command:

```
# /etc/init.d/vxfen.rc stop
# /etc/init.d/vxfen.rc start
```

If the command fails, restart the new node.

The vxfentsthdw utility fails when SCSI TEST UNIT READY command fails

While running the vxfentsthdw utility, you may see a message that resembles as follows:

Issuing SCSI TEST UNIT READY to disk reserved by other node
 FAILED.
 Contact the storage provider to have the hardware configuration
 fixed.

The disk array does not support returning success for a SCSI TEST UNIT READY
 command when another host has the disk reserved using SCSI-3 persistent
 reservations. This happens with the Hitachi Data Systems 99XX arrays if bit 186
 of the system mode option is not enabled.

Manually removing existing keys from SCSI-3 disks

Review the following procedure to remove specific registration and reservation keys
 created by another node from a disk.

See [“About the vxfenadm utility”](#) on page 368.

Note: If you want to clear all the pre-existing keys, use the vxfenclearpre utility.

See [“About the vxfenclearpre utility”](#) on page 373.

To remove the registration and reservation keys from disk

- 1 Create a file to contain the access names of the disks:

```
# vi /tmp/disklist
```

For example:

```
/dev/rhdisk74
```

- 2 Read the existing keys:

```
# vxfenadm -s all -f /tmp/disklist
```

The output from this command displays the key:

```
Device Name: /dev/rhdisk74
```

```
Total Number Of Keys: 1
```

```
key[0]:
```

```
[Numeric Format]: 86,70,66,69,65,68,48,50
```

```
[Character Format]: VFBEAD02
```

```
[Node Format]: Cluster ID: 48813 Node ID: 2
```

```
Node Name: unknown
```

- 3** If you know on which node the key (say A1) was created, log in to that node and enter the following command:

```
# vxfenadm -x -kA1 -f /tmp/disklist
```

The key A1 is removed.

- 4** If you do not know on which node the key was created, follow [5](#) through [7](#) to remove the key.

- 5** Register a second key “A2” temporarily with the disk:

```
# vxfenadm -m -k A2 -f /tmp/disklist
```

```
Registration completed for disk path /dev/rhdisk74
```

- 6** Remove the first key from the disk by preempting it with the second key:

```
# vxfenadm -p -kA2 -f /tmp/disklist -vA1
```

```
key: A2----- preempted the key: A1----- on disk
```

```
/dev/rhdisk74
```

- 7** Remove the temporary key registered in [5](#).

```
# vxfenadm -x -kA2 -f /tmp/disklist
```

```
Deleted the key : [A2-----] from device /dev/rhdisk74
```

No registration keys exist for the disk.

System panics to prevent potential data corruption

When a node experiences a split-brain condition and is ejected from the cluster, it panics and displays the following console message:

```
VXFEN:vxfen_plat_panic: Local cluster node ejected from cluster to prevent potential data corruption.
```

A node experiences the split-brain condition when it loses the heartbeat with its peer nodes due to failure of all private interconnects or node hang. Review the behavior of I/O fencing under different scenarios and the corrective measures to be taken.

See [“How I/O fencing works in different event scenarios”](#) on page 345.

Cluster ID on the I/O fencing key of coordinator disk does not match the local cluster's ID

If you accidentally assign coordinator disks of a cluster to another cluster, then the fencing driver displays an error message similar to the following when you start I/O fencing:

```
000068 06:37:33 2bdd5845 0 ... 3066 0 VXFEN WARNING V-11-1-56
Coordinator disk has key with cluster id 48813
which does not match local cluster id 57069
```

The warning implies that the local cluster with the cluster ID 57069 has keys. However, the disk also has keys for cluster with ID 48813 which indicates that nodes from the cluster with cluster id 48813 potentially use the same coordinator disk.

You can run the following commands to verify whether these disks are used by another cluster. Run the following commands on one of the nodes in the local cluster. For example, on sys1:

```
sys1> # lltstat -C
57069

sys1> # cat /etc/vxfentab
/dev/vx/rdmp/disk_7
/dev/vx/rdmp/disk_8
/dev/vx/rdmp/disk_9

sys1> # vxfenadm -s /dev/vx/rdmp/disk_7
Reading SCSI Registration Keys...
Device Name: /dev/vx/rdmp/disk_7
Total Number Of Keys: 1
key[0]:
[Numeric Format]: 86,70,48,49,52,66,48,48
[Character Format]: VFBEAD00
[Node Format]: Cluster ID: 48813 Node ID: 0 Node Name: unknown
```

Where *disk_7*, *disk_8*, and *disk_9* represent the disk names in your setup.

Recommended action: You must use a unique set of coordinator disks for each cluster. If the other cluster does not use these coordinator disks, then clear the keys using the `vxfenclearpre` command before you use them as coordinator disks in the local cluster.

See [“About the vxfenclearpre utility”](#) on page 373.

Fencing startup reports preexisting split-brain

The vxfen driver functions to prevent an ejected node from rejoining the cluster after the failure of the private network links and before the private network links are repaired.

For example, suppose the cluster of system 1 and system 2 is functioning normally when the private network links are broken. Also suppose system 1 is the ejected system. When system 1 restarts before the private network links are restored, its membership configuration does not show system 2; however, when it attempts to register with the coordinator disks, it discovers system 2 is registered with them. Given this conflicting information about system 2, system 1 does not join the cluster and returns an error from vxfenconfig that resembles:

```
vxfenconfig: ERROR: There exists the potential for a preexisting
split-brain. The coordinator disks list no nodes which are in
the current membership. However, they also list nodes which are
not in the current membership.
```

```
I/O Fencing Disabled!
```

Also, the following information is displayed on the console:

```
<date> <system name> vxfen: WARNING: Potentially a preexisting
<date> <system name> split-brain.
<date> <system name> Dropping out of cluster.
<date> <system name> Refer to user documentation for steps
<date> <system name> required to clear preexisting split-brain.
<date> <system name>
<date> <system name> I/O Fencing DISABLED!
<date> <system name>
<date> <system name> gab: GAB:20032: Port b closed
```

However, the same error can occur when the private network links are working and both systems go down, system 1 restarts, and system 2 fails to come back up. From the view of the cluster from system 1, system 2 may still have the registrations on the coordination points.

Assume the following situations to understand preexisting split-brain in server-based fencing:

- There are three CP servers acting as coordination points. One of the three CP servers then becomes inaccessible. While in this state, one client node leaves the cluster, whose registration cannot be removed from the inaccessible CP server. When the inaccessible CP server restarts, it has a stale registration from the node which left the VCS cluster. In this case, no new nodes can join the cluster. Each node that attempts to join the cluster gets a list of registrations

from the CP server. One CP server includes an extra registration (of the node which left earlier). This makes the joiner node conclude that there exists a preexisting split-brain between the joiner node and the node which is represented by the stale registration.

- All the client nodes have crashed simultaneously, due to which fencing keys are not cleared from the CP servers. Consequently, when the nodes restart, the vxfen configuration fails reporting preexisting split brain.

These situations are similar to that of preexisting split-brain with coordinator disks, where you can solve the problem running the `vxfenclearpre` command. A similar solution is required in server-based fencing using the `cpsadm` command.

See [“Clearing preexisting split-brain condition”](#) on page 727.

Clearing preexisting split-brain condition

Review the information on how the VxFEN driver checks for preexisting split-brain condition.

See [“Fencing startup reports preexisting split-brain”](#) on page 726.

See [“About the vxfenclearpre utility”](#) on page 373.

[Table 24-3](#) describes how to resolve a preexisting split-brain condition depending on the scenario you have encountered:

Table 24-3 Recommended solution to clear pre-existing split-brain condition

Scenario	Solution
Actual potential split-brain condition—system 2 is up and system 1 is ejected	<ol style="list-style-type: none"> 1 Determine if system1 is up or not. 2 If system 1 is up and running, shut it down and repair the private network links to remove the split-brain condition. 3 Restart system 1.

Table 24-3 Recommended solution to clear pre-existing split-brain condition
(continued)

Scenario	Solution
<p>Apparent potential split-brain condition—system 2 is down and system 1 is ejected</p> <p>(Disk-based fencing is configured)</p>	<ol style="list-style-type: none"> <li data-bbox="362 347 1221 572"> <p>1 Physically verify that system 2 is down.</p> <p>Verify the systems currently registered with the coordination points.</p> <p>Use the following command for coordinator disks:</p> <pre data-bbox="413 493 852 513"># vxfenadm -s all -f /etc/vxfentab</pre> <p>The output of this command identifies the keys registered with the coordinator disks.</p> <li data-bbox="362 576 1221 720"> <p>2 Clear the keys on the coordinator disks as well as the data disks in all shared disk groups using the <code>vxfenclearpre</code> command. The command removes SCSI-3 registrations and reservations.</p> <p>See “About the vxfenclearpre utility” on page 373.</p> <li data-bbox="362 723 1221 755"> <p>3 Make any necessary repairs to system 2.</p> <li data-bbox="362 758 1221 815"> <p>4 Restart system 2.</p>
<p>Apparent potential split-brain condition—system 2 is down and system 1 is ejected</p> <p>(Server-based fencing is configured)</p>	<ol style="list-style-type: none"> <li data-bbox="362 819 1221 1154"> <p>1 Physically verify that system 2 is down.</p> <p>Verify the systems currently registered with the coordination points.</p> <p>Use the following command for CP servers:</p> <pre data-bbox="413 968 928 1020"># cpsadm -s cp_server -a list_membership -c cluster_name</pre> <p>where <code>cp_server</code> is the virtual IP address or virtual hostname on which CP server is configured, and <code>cluster_name</code> is the VCS name for the VCS cluster (application cluster).</p> <p>The command lists the systems registered with the CP server.</p> <li data-bbox="362 1157 1221 1293"> <p>2 Clear the keys on the coordinator disks as well as the data disks in all shared disk groups using the <code>vxfenclearpre</code> command. The command removes SCSI-3 registrations and reservations.</p> <p>After removing all stale registrations, the joiner node will be able to join the cluster.</p> <li data-bbox="362 1296 1221 1328"> <p>3 Make any necessary repairs to system 2.</p> <li data-bbox="362 1331 1221 1388"> <p>4 Restart system 2.</p>

Registered keys are lost on the coordinator disks

If the coordinator disks lose the keys that are registered, the cluster might panic when a cluster reconfiguration occurs.

To refresh the missing keys

- ◆ Use the `vxfsnwap` utility to replace the coordinator disks with the same disks. The `vxfsnwap` utility registers the missing keys during the disk replacement. See [“Refreshing lost keys on coordinator disks”](#) on page 387.

Replacing defective disks when the cluster is offline

If the disk in the coordinator disk group becomes defective or inoperable and you want to switch to a new diskgroup in a cluster that is offline, then perform the following procedure.

In a cluster that is online, you can replace the disks using the `vxfsnwap` utility.

See [“About the vxfsnwap utility”](#) on page 376.

Review the following information to replace coordinator disk in the coordinator disk group, or to destroy a coordinator disk group.

Note the following about the procedure:

- When you add a disk, add the disk to the disk group `vxfsncoorddg` and retest the group for support of SCSI-3 persistent reservations.
- You can destroy the coordinator disk group such that no registration keys remain on the disks. The disks can then be used elsewhere.

To replace a disk in the coordinator disk group when the cluster is offline

1 Log in as superuser on one of the cluster nodes.

2 If VCS is running, shut it down:

```
# hastop -all
```

Make sure that the port `h` is closed on all the nodes. Run the following command to verify that the port `h` is closed:

```
# gabconfig -a
```

3 Stop I/O fencing on each node:

```
# /etc/init.d/vxfen.rc stop
```

This removes any registration keys on the disks.

- 4 Import the coordinator disk group. The file `/etc/vxfendg` includes the name of the disk group (typically, `vxfencoordg`) that contains the coordinator disks, so use the command:

```
# vxdg -tfc import `cat /etc/vxfendg`
```

where:

-t specifies that the disk group is imported only until the node restarts.

-f specifies that the import is to be done forcibly, which is necessary if one or more disks is not accessible.

-C specifies that any import locks are removed.

- 5 To remove disks from the disk group, use the VxVM disk administrator utility, `vxdiskadm`.

You may also destroy the existing coordinator disk group. For example:

- Verify whether the coordinator attribute is set to on.

```
# vxdg list vxfencoordg | grep flags: | grep coordinator
```

- Destroy the coordinator disk group.

```
# vxdg -o coordinator destroy vxfencoordg
```

- 6 Add the new disk to the node and initialize it as a VxVM disk.

Then, add the new disk to the `vxfencoordg` disk group:

- If you destroyed the disk group in step 5, then create the disk group again and add the new disk to it.

See the *Cluster Server Installation Guide* for detailed instructions.

- If the diskgroup already exists, then add the new disk to it.

```
# vxdg -g vxfencoordg -o coordinator adddisk disk_name
```

- 7 Test the recreated disk group for SCSI-3 persistent reservations compliance.

See “[Testing the coordinator disk group using the -c option of vxfentsthdw](#)” on page 362.

- 8 After replacing disks in a coordinator disk group, deport the disk group:

```
# vxdg deport `cat /etc/vxfendg`
```

- 9** On each node, start the I/O fencing driver:

```
# /etc/init.d/vxfen.rc start
```

- 10** Verify that the I/O fencing module has started and is enabled.

```
# gabconfig -a
```

Make sure that port b membership exists in the output for all nodes in the cluster.

```
# vxfenadm -d
```

Make sure that I/O fencing mode is not disabled in the output.

- 11** If necessary, restart VCS on each node:

```
# hastart
```

The vxfenswap utility exits if rcp or scp commands are not functional

The vxfenswap utility displays an error message if rcp or scp commands are not functional.

To recover the vxfenswap utility fault

- ◆ Verify whether the rcp or scp functions properly.

Make sure that you do not use echo or cat to print messages in the .bashrc file for the nodes.

If the vxfenswap operation is unsuccessful, use the `vxfenswap -a cancel` command if required to roll back any changes that the utility made.

See [“About the vxfenswap utility”](#) on page 376.

Troubleshooting CP server

All CP server operations and messages are logged in the `/var/VRTScps/log` directory in a detailed and easy to read format. The entries are sorted by date and time. The logs can be used for troubleshooting purposes or to review for any possible security issue on the system that hosts the CP server.

The following files contain logs and text files that may be useful in understanding and troubleshooting a CP server:

- `/var/VRTScps/log/cpsvr_[ABC].log`
- `/var/VRTScps/log/vcsauthserver.log` (Security related)

- If the vxcperv process fails on the CP server, then review the following diagnostic files:
 - `/var/VRTScps/diag/FFDC_CPS_pid_vxcperv.log`
 - `/var/VRTScps/diag/stack_pid_vxcperv.txt`

Note: If the vxcperv process fails on the CP server, these files are present in addition to a core file. VCS restarts vxcperv process automatically in such situations.

The file `/var/VRTSvcs/log/vxfen/vxfend_[ABC].log` contains logs that may be useful in understanding and troubleshooting fencing-related issues on a VCS cluster (client cluster) node.

See [“Troubleshooting issues related to the CP server service group”](#) on page 732.

See [“Checking the connectivity of CP server”](#) on page 732.

See [“Issues during fencing startup on VCS cluster nodes set up for server-based fencing”](#) on page 733.

See [“Issues during online migration of coordination points”](#) on page 734.

Troubleshooting issues related to the CP server service group

If you cannot bring up the CPSSG service group after the CP server configuration, perform the following steps:

- Verify that the CPSSG service group and its resources are valid and properly configured in the VCS configuration.
- Check the VCS engine log (`/var/VRTSvcs/log/engine_[ABC].log`) to see if any of the CPSSG service group resources are FAULTED.
- Review the sample dependency graphs to make sure the required resources are configured correctly.
 See [“About the CP server service group”](#) on page 333.

Checking the connectivity of CP server

You can test the connectivity of CP server using the `cpsadm` command.

You must have set the environment variables `CPS_USERNAME` and `CPS_DOMAINTYPE` to run the `cpsadm` command on the VCS cluster (client cluster) nodes.

To check the connectivity of CP server

- ◆ Run the following command to check whether a CP server is up and running at a process level:

```
# cpsadm -s cp_server -a ping_cps
```

where *cp_server* is the virtual IP address or virtual hostname on which the CP server is listening.

Troubleshooting server-based fencing on the VCS cluster nodes

The file `/var/VRTSvcs/log/vxfen/vxfend_[ABC].log` contains logs files that may be useful in understanding and troubleshooting fencing-related issues on a VCS cluster (application cluster) node.

Issues during fencing startup on VCS cluster nodes set up for server-based fencing

Table 24-4 Fencing startup issues on VCS cluster (client cluster) nodes

Issue	Description and resolution
<p><code>cpsadm</code> command on the VCS cluster gives connection error</p>	<p>If you receive a connection error message after issuing the <code>cpsadm</code> command on the VCS cluster, perform the following actions:</p> <ul style="list-style-type: none"> ■ Ensure that the CP server is reachable from all the VCS cluster nodes. ■ Check the <code>/etc/vxfenmode</code> file and ensure that the VCS cluster nodes use the correct CP server virtual IP or virtual hostname and the correct port number. ■ For HTTPS communication, ensure that the virtual IP and ports listed for the server can listen to HTTPS requests.
<p>Authorization failure</p>	<p>Authorization failure occurs when the nodes on the client clusters and or users are not added in the CP server configuration. Therefore, fencing on the VCS cluster (client cluster) node is not allowed to access the CP server and register itself on the CP server. Fencing fails to come up if it fails to register with a majority of the coordination points.</p> <p>To resolve this issue, add the client cluster node and user in the CP server configuration and restart fencing.</p>

Table 24-4 Fencing startup issues on VCS cluster (client cluster) nodes
(continued)

Issue	Description and resolution
Authentication failure	<p>If you had configured secure communication between the CP server and the VCS cluster (client cluster) nodes, authentication failure can occur due to the following causes:</p> <ul style="list-style-type: none"> ■ The client cluster requires its own private key, a signed certificate, and a Certification Authority's (CA) certificate to establish secure communication with the CP server. If any of the files are missing or corrupt, communication fails. ■ If the client cluster certificate does not correspond to the client's private key, communication fails. ■ If the CP server and client cluster do not have a common CA in their certificate chain of trust, then communication fails. <p>See “About secure communication between the VCS cluster and CP server” on page 335.</p>

Issues during online migration of coordination points

During online migration of coordination points using the `vxfenmode` utility, the operation is automatically rolled back if a failure is encountered during validation of coordination points from any of the cluster nodes.

Validation failure of the new set of coordination points can occur in the following circumstances:

- The `/etc/vxfenmode.test` file is not updated on all the VCS cluster nodes, because new coordination points on the node were being picked up from an old `/etc/vxfenmode.test` file. The `/etc/vxfenmode.test` file must be updated with the current details. If the `/etc/vxfenmode.test` file is not present, `vxfenmode` copies configuration for new coordination points from the `/etc/vxfenmode` file.
- The coordination points listed in the `/etc/vxfenmode` file on the different VCS cluster nodes are not the same. If different coordination points are listed in the `/etc/vxfenmode` file on the cluster nodes, then the operation fails due to failure during the coordination point snapshot check.
- There is no network connectivity from one or more VCS cluster nodes to the CP server(s).
- Cluster, nodes, or users for the VCS cluster nodes have not been added on the new CP servers, thereby causing authorization failure.

Vxfen service group activity after issuing the `vxfenmode` command

The Coordination Point agent reads the details of coordination points from the `vxfenconfig -l` output and starts monitoring the registrations on them.

Thus, during `vxfenswap`, when the `vxfenmode` file is being changed by the user, the Coordination Point agent does not move to FAULTED state but continues monitoring the old set of coordination points.

As long as the changes to `vxfenmode` file are not committed or the new set of coordination points are not reflected in `vxfenconfig -l` output, the Coordination Point agent continues monitoring the old set of coordination points it read from `vxfenconfig -l` output in every monitor cycle.

The status of the Coordination Point agent (either ONLINE or FAULTED) depends upon the accessibility of the coordination points, the registrations on these coordination points, and the fault tolerance value.

When the changes to `vxfenmode` file are committed and reflected in the `vxfenconfig -l` output, then the Coordination Point agent reads the new set of coordination points and proceeds to monitor them in its new monitor cycle.

Troubleshooting notification

Occasionally you may encounter problems when using VCS notification. This section cites the most common problems and the recommended actions. Bold text provides a description of the problem.

Notifier is configured but traps are not seen on SNMP console.

Recommended Action: Verify the version of SNMP traps supported by the console: VCS notifier sends SNMP v2.0 traps. If you are using HP OpenView Network Node Manager as the SNMP, verify events for VCS are configured using `xnmevents`. You may also try restarting the OpenView daemon (`ovw`) if, after merging VCS events in `vcs_trapd`, the events are not listed in the OpenView Network Node Manager Event configuration.

By default, notifier assumes the community string is public. If your SNMP console was configured with a different community, reconfigure it according to the notifier configuration. See the *Cluster Server Bundled Agents Reference Guide* for more information on NotifierMgr.

Troubleshooting and recovery for global clusters

This topic describes the concept of disaster declaration and provides troubleshooting tips for configurations using global clusters.

Disaster declaration

When a cluster in a global cluster transitions to the FAULTED state because it can no longer be contacted, failover executions depend on whether the cause was due to a split-brain, temporary outage, or a permanent disaster at the remote cluster.

If you choose to take action on the failure of a cluster in a global cluster, VCS prompts you to declare the type of failure.

- *Disaster*, implying permanent loss of the primary data center
- *Outage*, implying the primary may return to its current form in some time
- *Disconnect*, implying a split-brain condition; both clusters are up, but the link between them is broken
- *Replica*, implying that data on the takeover target has been made consistent from a backup source and that the RVGPrimary can initiate a takeover when the service group is brought online. This option applies to VVR environments only.

You can select the groups to be failed over to the local cluster, in which case VCS brings the selected groups online on a node based on the group's FailOverPolicy attribute. It also marks the groups as being offline in the other cluster. If you do not select any service groups to fail over, VCS takes no action except implicitly marking the service groups as offline on the downed cluster.

Lost heartbeats and the inquiry mechanism

The loss of internal and all external heartbeats between any two clusters indicates that the remote cluster is faulted, or that all communication links between the two clusters are broken (a wide-area split-brain).

VCS queries clusters to confirm the remote cluster to which heartbeats have been lost is truly down. This mechanism is referred to as inquiry. In a two-cluster configuration a connector loses all heartbeats to the other connector, it must consider the remote cluster faulted. If there are more than two clusters and a connector loses all heartbeats to a second cluster, it queries the remaining connectors before declaring the cluster faulted. If the other connectors view the cluster as running, the querying connector transitions the cluster to the UNKNOWN state, a process that minimizes false cluster faults. If all connectors report that the cluster is faulted, the querying connector also considers it faulted and transitions the remote cluster state to FAULTED.

VCS alerts

VCS alerts are identified by the alert ID, which is comprised of the following elements:

- `alert_type`—The type of the alert
- `cluster`—The cluster on which the alert was generated
- `system`—The system on which this alert was generated
- `object`—The name of the VCS object for which this alert was generated. This could be a cluster or a service group.

Alerts are generated in the following format:

```
alert_type-cluster-system-object
```

For example:

```
GNOFAILA-Cluster1-oracle_grp
```

This is an alert of type GNOFAILA generated on cluster Cluster1 for the service group oracle_grp.

Types of alerts

VCS generates the following types of alerts.

- CFAULT—Indicates that a cluster has faulted
- GNOFAILA—Indicates that a global group is unable to fail over within the cluster where it was online. This alert is displayed if the ClusterFailOverPolicy attribute is set to Manual and the wide-area connector (wac) is properly configured and running at the time of the fault.
- GNOFAIL—Indicates that a global group is unable to fail over to any system within the cluster or in a remote cluster.

Some reasons why a global group may not be able to fail over to a remote cluster:

- The ClusterFailOverPolicy is set to either Auto or Connected and VCS is unable to determine a valid remote cluster to which to automatically fail the group over.
- The ClusterFailOverPolicy attribute is set to Connected and the cluster in which the group has faulted cannot communicate with one or more remote clusters in the group's ClusterList.
- The wide-area connector (wac) is not online or is incorrectly configured in the cluster in which the group has faulted

Managing alerts

Alerts require user intervention. You can respond to an alert in the following ways:

- If the reason for the alert can be ignored, use the Alerts dialog box in the Java console or the `haalert` command to delete the alert. You must provide a comment as to why you are deleting the alert; VCS logs the comment to engine log.
- Take an action on administrative alerts that have actions associated with them.
- VCS deletes or negates some alerts when a negating event for the alert occurs.

An administrative alert will continue to live if none of the above actions are performed and the VCS engine (HAD) is running on at least one node in the cluster. If HAD is not running on any node in the cluster, the administrative alert is lost.

Actions associated with alerts

This section describes the actions you can perform on the following types of alerts:

- CFAULT—When the alert is presented, clicking **Take Action** guides you through the process of failing over the global groups that were online in the cluster before the cluster faulted.
- GNOFAILA—When the alert is presented, clicking **Take Action** guides you through the process of failing over the global group to a remote cluster on which the group is configured to run.
- GNOFAIL—There are no associated actions provided by the consoles for this alert

Negating events

VCS deletes a CFAULT alert when the faulted cluster goes back to the running state

VCS deletes the GNOFAILA and GNOFAIL alerts in response to the following events:

- The faulted group's state changes from FAULTED to ONLINE.
- The group's fault is cleared.
- The group is deleted from the cluster where alert was generated.

Concurrency violation at startup

VCS may report a concurrency violation when you add a cluster to the ClusterList of the service group. A concurrency violation means that the service group is online on two nodes simultaneously.

Recommended Action: Verify the state of the service group in each cluster before making the service group global.

Troubleshooting the steward process

When you start the steward, it blocks the command prompt and prints messages to the standard output. To stop the steward, run the following command from a different command prompt of the same system:

If the steward is running in secure mode: `steward -stop - secure`

If the steward is not running in secure mode: `steward -stop`

In addition to the standard output, the steward can log to its own log files:

- `steward_A.log`
- `steward-err_A.log`

Use the `tststew` utility to verify that:

- The steward process is running
- The steward process is sending the right response

Troubleshooting licensing

This section cites problems you may encounter with VCS licensing. It provides instructions on how to validate license keys and lists the error messages associated with licensing.

Validating license keys

The `installvcs` script handles most license key validations. However, if you install a VCS key outside of `installvcs` (using `vxlicinst`, for example), you can validate the key using the procedure described below.

- 1 The `vxlicinst` command handles some of the basic validations:

node lock: Ensures that you are installing a node-locked key on the correct system

demo hard end date: Ensures that you are not installing an expired demo key

- 2 Run the `vxlicrep` command to make sure a VCS key is installed on the system. The output of the command resembles:

```
License Key      = XXXX-XXXX-XXXX-XXXX-XXXX-XXXX
Product Name    = VERITAS Cluster Server
Serial number   = XXXX
License Type    = PERMANENT
OEM ID         = XXXX
Site License    = YES
Editions Product = YES
Features :
Platform:      = Unused
Version        = 7.1
Tier           = Tiern3
Reserved       = 0
Mode           = VCS
Global Cluster Option = Enabled
CPU_TIER       = 0
```

- 3 Look for the following in the command output:

Make sure the Product Name lists the name of your purchased component, for example, Cluster Server. If the command output does not return the product name, you do not have a VCS key installed.

If the output shows the License Type for a VCS key as DEMO, ensure that the Demo End Date does not display a past date.

Make sure the *Mode* attribute displays the correct value.

If you have purchased a license key for the Global Cluster Option, make sure its status is Enabled.

- 4 Start VCS. If HAD rejects a license key, see the licensing error message at the end of the `engine_A` log file.

Licensing error messages

This section lists the error messages associated with licensing. These messages are logged to the file `/var/VRTSVcs/log/engine_A.log`.

[Licensing] Insufficient memory to perform operation

The system does not have adequate resources to perform licensing operations.

[Licensing] No valid VCS license keys were found

No valid VCS keys were found on the system.

[Licensing] Unable to find a valid base VCS license key

No valid base VCS key was found on the system.

[Licensing] License key cannot be used on this OS platform

This message indicates that the license key was meant for a different platform. For example, a license key meant for Windows is used on AIX platform.

[Licensing] VCS evaluation period has expired

The VCS base demo key has expired

[Licensing] License key can not be used on this system

Indicates that you have installed a key that was meant for a different system (i.e. node-locked keys)

[Licensing] Unable to initialize the licensing framework

This is a VCS internal message. Call Veritas Technical Support.

[Licensing] QuickStart is not supported in this release

VCS QuickStart is not supported in this version of VCS.

[Licensing] Your evaluation period for the feature has expired. This feature will not be enabled the next time VCS starts

The evaluation period for the specified VCS feature has expired.

Troubleshooting secure configurations

This section includes error messages associated with configuring security and configuring FIPS mode. It also provides descriptions about the messages and the recommended action.

FIPS mode cannot be set

When you use the `vcscrypt` command or `vcscdecrypt` command or use utilities such as `hawparsetup` that use these commands, the system sometimes displays the following error message:

```
VCS ERROR V-16-1-10351 Could not set FIPS mode
```

Recommended Action: Ensure that the random number generator is defined on your system for encryption to work correctly. Typically, the files required for random number generation are `/dev/random` and `/dev/urandom`.

Troubleshooting wizard-based configuration issues

This section lists common troubleshooting issues that you may encounter during or after the steps related to the VCS Cluster Configuration Wizard and the Veritas High Availability Configuration Wizard.

Running the 'hastop -all' command detaches virtual disks

The `hastop -all` command takes offline all the components and components groups of a configured application, and then stops the VCS cluster. In the process, the command detaches the virtual disks from the VCS cluster nodes. (2920101)

Workaround: If you want to stop the VCS cluster (and not the applications running on cluster nodes), instead of the “`hastop -all`”, use the following command:

```
hastop -all -force
```

This command stops the cluster without affecting the virtual disks attached to the VCS cluster nodes.

Troubleshooting issues with the Veritas High Availability view

This section lists common troubleshooting scenarios that you may encounter when using the Veritas High Availability view.

Veritas High Availability view does not display the application monitoring status

The Veritas High Availability view may either display a HTTP 404 Not Found error or may not show the application health status at all.

Verify the following conditions and then refresh the Veritas High Availability view:

- Verify that the VMware Web Service is running on the vCenter Server.
- Verify that the VMware Tools Service is running on the guest virtual machine.
- Verify that ports 14152, 14153, and 5634 are not blocked by a firewall.
- Log out of the vSphere Client and then login again. Then, verify that the Veritas High Availability plugin is installed and enabled.

Veritas High Availability view may freeze due to special characters in application display name

For a monitored application, if you specify a display name that contains special characters, one or both of the following symptoms may occur:

- The Veritas high availability view may freeze
- The Veritas high availability view may display an Adobe exception error message. Based on your browser settings, the Adobe exception message may or may not appear. However, in both cases the tab may freeze. (2923079)

Workaround:

Reset the display name using only those characters that belong to the following list:

- any alphanumeric character
- space
- underscore

Use the following command to reset the display name:

```
hagrp -modify sg name UserAssoc -update Name "modified display name without special characters"
```

In the Veritas High Availability tab, the Add Failover System link is dimmed

If the system that you clicked in the inventory view of the vSphere Client GUI to launch the Veritas High Availability tab is not part of the list of failover target systems for that application, the Add Failover System link is dimmed. (2932281)

Workaround: In the vSphere Client GUI inventory view, to launch the Veritas High Availability tab, click a system from the existing list of failover target systems for the application. The Add Failover System link that appears in the drop-down list if you click **More**, is no longer dimmed.

Appendixes

- [Appendix A. VCS user privileges—administration matrices](#)
- [Appendix B. VCS commands: Quick reference](#)
- [Appendix C. Cluster and system states](#)
- [Appendix D. VCS attributes](#)
- [Appendix E. Accessibility and VCS](#)

VCS user privileges—administration matrices

This appendix includes the following topics:

- [About administration matrices](#)
- [Administration matrices](#)

About administration matrices

In general, users with Guest privileges can run the following command options: -display, -state, and -value.

Users with privileges for Group Operator and Cluster Operator can execute the following options: -online, -offline, and -switch.

Users with Group Administrator and Cluster Administrator privileges can run the following options -add, -delete, and -modify.

See [“About VCS user privileges and roles”](#) on page 82.

Administration matrices

Review the matrices in the following topics to determine which command options can be executed within a specific user role. Checkmarks denote the command and option can be executed. A dash indicates they cannot.

Agent Operations (haagent)

[Table A-1](#) lists agent operations and required privileges.

Table A-1 User privileges for agent operations

Agent Operation	Guest	Group Operator	Group Admin.	Cluster Operator	Cluster Admin.
Start agent	–	–	–	✓	✓
Stop agent	–	–	–	✓	✓
Display info	✓	✓	✓	✓	✓
List agents	✓	✓	✓	✓	✓

Attribute Operations (haattr)

[Table A-2](#) lists attribute operations and required privileges.

Table A-2 User privileges for attribute operations

Attribute Operations	Guest	Group Operator	Group Admin.	Cluster Operator	Cluster Admin.
Add	–	–	–	–	✓
Change default value	–	–	–	–	✓
Delete	–	–	–	–	✓
Display	✓	✓	✓	✓	✓

Cluster Operations (haclus, haconf)

[Table A-3](#) lists cluster operations and required privileges.

Table A-3 User privileges for cluster operations

Cluster Operations	Cluster Guest	Group Operator	Group Admin.	Cluster Operator	Cluster Admin.
Display	✓	✓	✓	✓	✓
Modify	–	–	–	–	✓
Add	–	–	–	–	✓

Table A-3 User privileges for cluster operations (*continued*)

Cluster Operations	Cluster Guest	Group Operator	Group Admin.	Cluster Operator	Cluster Admin.
Delete	–	–	–	–	✓
Declare	–	–	–	✓	✓
View state or status	✓	✓	✓	✓	✓
Update license	–	–	–	–	✓
Make configuration read-write	–	–	✓	–	✓
Save configuration	–	–	✓	–	✓
Make configuration read-only	–	–	✓	–	✓

Service group operations (hagrp)

[Table A-4](#) lists service group operations and required privileges.

Table A-4 User privileges for service group operations

Service Group Operations	Guest	Group Operator	Group Admin.	Cluster Operator	Cluster Admin.
Add and delete	–	–	–	–	✓
Link and unlink	–	–	–	–	✓
Clear	–	✓	✓	✓	✓
Bring online	–	✓	✓	✓	✓
Take offline	–	✓	✓	✓	✓
View state	✓	✓	✓	✓	✓
Switch	–	✓	✓	✓	✓
Freeze/unfreeze	–	✓	✓	✓	✓
Freeze/unfreeze persistent	–	–	✓	–	✓
Enable	–	–	✓	–	✓

Table A-4 User privileges for service group operations (*continued*)

Service Group Operations	Guest	Group Operator	Group Admin.	Cluster Operator	Cluster Admin.
Disable	–	–	✓	–	✓
Modify	–	–	✓	–	✓
Display	✓	✓	✓	✓	✓
View dependencies	✓	✓	✓	✓	✓
View resources	✓	✓	✓	✓	✓
List	✓	✓	✓	✓	✓
Enable resources	–	–	✓	–	✓
Disable resources	–	–	✓	–	✓
Flush	–	✓	✓	✓	✓
Autoenable	–	✓	✓	✓	✓
Ignore	–	✓	✓	✓	✓

Heartbeat operations (hahb)

[Table A-5](#) lists heartbeat operations and required privileges.

Table A-5 User privileges for heartbeat operations

Heartbeat Operations	Guest	Group Operator	Group Admin.	Cluster Operator	Cluster Admin.
Add	–	–	–	–	✓
Delete	–	–	–	–	✓
Make local	–	–	–	–	✓
Make global	–	–	–	–	✓
Display	✓	✓	✓	✓	✓
View state	✓	✓	✓	✓	✓
List	✓	✓	✓	✓	✓

Log operations (halog)

[Table A-6](#) lists log operations and required privileges.

Table A-6 User privileges for log operations

Log operations	Guest	Group Operator	Group Admin.	Cluster Operator	Cluster Admin.
Enable debug tags	–	–	–	–	✓
Delete debug tags	–	–	–	–	✓
Add messages to log file	–	–	✓	–	✓
Display	✓	✓	✓	✓	✓
Display log file info	✓	✓	✓	✓	✓

Resource operations (hares)

[Table A-7](#) lists resource operations and required privileges.

Table A-7 User privileges for resource operations

Resource operations	Guest	Group Operator	Group Admin.	Cluster Operator	Cluster Admin.
Add	–	–	✓	–	✓
Delete	–	–	✓	–	✓
Make attribute local	–	–	✓	–	✓
Make attribute global	–	–	✓	–	✓
Link and unlink	–	–	✓	–	✓
Clear	–	✓	✓	✓	✓
Bring online	–	✓	✓	✓	✓
Take offline	–	✓	✓	✓	✓
Modify	–	–	✓	–	✓
View state	✓	✓	✓	✓	✓

Table A-7 User privileges for resource operations (*continued*)

Resource operations	Guest	Group Operator	Group Admin.	Cluster Operator	Cluster Admin.
Display	✓	✓	✓	✓	✓
View dependencies	✓	✓	✓	✓	✓
List, Value	✓	✓	✓	✓	✓
Probe	–	✓	✓	✓	✓
Override attribute	–	–	✓	–	✓
Remove overrides	–	–	✓	–	✓
Run an action	–	✓	✓	✓	✓
Refresh info	–	✓	✓	✓	✓
Flush info	–	✓	✓	✓	✓

System operations (hasys)

[Table A-8](#) lists system operations and required privileges.

Table A-8 User privileges for system operations

System operations	Guest	Group Operator	Group Admin.	Cluster Operator	Cluster Admin.
Add	–	–	–	–	✓
Delete	–	–	–	–	✓
Freeze and unfreeze	–	–	–	✓	✓
Freeze and unfreeze persistent	–	–	–	–	✓
Freeze and evacuate	–	–	–	–	✓
Display	✓	✓	✓	✓	✓
Start forcibly	–	–	–	–	✓
Modify	–	–	–	–	✓

Table A-8 User privileges for system operations (*continued*)

System operations	Guest	Group Operator	Group Admin.	Cluster Operator	Cluster Admin.
View state	✓	✓	✓	✓	✓
List	✓	✓	✓	✓	✓
Update license	–	–	–	–	✓

Resource type operations (hatype)

[Table A-9](#) lists resource type operations and required privileges.

Table A-9 User privileges for resource type operations

Resource type operations	Guest	Group Operator	Group Admin.	Cluster Operator	Cluster Admin.
Add	–	–	–	–	✓
Delete	–	–	–	–	✓
Display	✓	✓	✓	✓	✓
View resources	✓	✓	✓	✓	✓
Modify	–	–	–	–	✓
List	✓	✓	✓	✓	✓

User operations (hauser)

[Table A-10](#) lists user operations and required privileges.

Table A-10 User privileges for user operations

User operations	Guest	Group Operator	Group Admin.	Cluster Operator	Cluster Admin.
Add	–	–	–	–	✓
Delete	–	–	–	–	✓

Table A-10 User privileges for user operations (*continued*)

User operations	Guest	Group Operator	Group Admin.	Cluster Operator	Cluster Admin.
Update	✓ Note: If configuration is read/write	✓ Note: If configuration is read/write	✓	✓ Note: If configuration is read/write	✓
Display	✓	✓	✓	✓	✓
List	✓	✓	✓	✓	✓
Modify privileges	–	–	✓	–	✓

VCS commands: Quick reference

This appendix includes the following topics:

- [About this quick reference for VCS commands](#)
- [VCS command line reference](#)

About this quick reference for VCS commands

This section lists commonly-used VCS commands and options. For more information about VCS commands and available options, see the man pages associated with VCS commands.

VCS command line reference

[Table B-1](#) lists the VCS commands for cluster operations.

Table B-1 VCS commands for cluster operations

Cluster operations	Command line
Start VCS	<code>hastart [-onenode]</code> <code>hasys -force system_name</code>

Table B-1 VCS commands for cluster operations (*continued*)

Cluster operations	Command line
Stop VCS	<pre>hastop -local [-force -evacuate -noautodisable] hastop -local [-force -evacuate -noautodisable] hastop -sys system_name [-force -evacuate -noautodisable] hastop -sys system_name [-force -evacuate -noautodisable] hastop -all [-force]</pre>
Enable/disable read-write access to VCS configuration	<pre>haconf -makerw haconf -dump -makero</pre>
Add user	<pre>hauser -add user_name</pre>

[Table B-2](#) lists the VCS commands for service group, resource, and site operations.

Table B-2 VCS commands for service group, resource, and site operations

Service group, resource, or site operations	Command line
Configure service groups	<pre>hagrp -add -delete group_name hagrp -modify group attribute value hagrp -link parent_group child_group dependency</pre>
Configure resources	<pre>hares -add resource type group_name hares -delete resource_name hares -modify resource attribute value hares -link parent_resource child_resource</pre>
Configure agents or resource types	<pre>hatype -modify type attribute value</pre>

Table B-2 VCS commands for service group, resource, and site operations
(continued)

Service group, resource, or site operations	Command line
Bring service groups online and take them offline	<pre>hagrp -online service_group -sys system_name hagrp -online service_group -site site_name hagrp -offline service_group -sys system_name hagrp -offline service_group -site site_name</pre>
Bring resources online and take them offline	<pre>hares -online resource_name -sys system_name hares -offline resource_name -sys system_name</pre>
Freezing/unfreezing service groups	<pre>hagrp -freeze group_name [-persistent] hagrp -unfreeze group_name [-persistent]</pre>

[Table B-3](#) lists the VCS commands for status and verification.

Table B-3 VCS commands for status and verification

Status and verification	Command line
Cluster status	<pre>hastatus -summary</pre>
LLT status/verification	<pre>lltconfig lltconfig -a list lltstat lltstat -nvv</pre>
GAB status/verification	<pre>gabconfig -a</pre>
AMF kernel driver status/verification	<pre>amfconfig amfstat</pre>

[Table B-4](#) lists the VCS commands for cluster communication.

Table B-4 VCS commands for cluster communication

Communication	Command line
Starting and stopping LLT	<pre>lltconfig -c lltconfig -U</pre>

Table B-4 VCS commands for cluster communication (*continued*)

Communication	Command line
Starting and stopping GAB	<code>gabconfig -c -n seed_number</code> <code>gabconfig -U</code>

[Table B-5](#) lists the VCS commands for system operations.

Table B-5 VCS commands for system operations

System operations	Command line
List systems in a cluster	<code>hasys -list</code>
Retrieve detailed information about each system	<code>hasys -display system_name</code>
Freezing/unfreezing systems	<code>hasys -freeze [-persistent] [-evacuate] system_name</code> <code>hasys -unfreeze [-persistent] system_name</code>

Cluster and system states

This appendix includes the following topics:

- [Remote cluster states](#)
- [System states](#)

Remote cluster states

In global clusters, the "health" of the remote clusters is monitored and maintained by the wide-area connector process. The connector process uses heartbeats, such as `lcmp`, to monitor the state of remote clusters. The state is then communicated to HAD, which then uses the information to take appropriate action when required. For example, when a cluster is shut down gracefully, the connector transitions its local cluster state to `EXITING` and notifies the remote clusters of the new state. When the cluster exits and the remote connectors lose their TCP/IP connection to it, each remote connector transitions their view of the cluster to `EXITED`.

To enable wide-area network heartbeats, the wide-area connector process must be up and running. For wide-area connectors to connect to remote clusters, at least one heartbeat to the specified cluster must report the state as `ALIVE`.

There are three heartbeat states for remote clusters: `HBUNKNOWN`, `HBALIVE`, and `HBDEAD`.

See ["Examples of system state transitions"](#) on page 762.

[Table C-1](#) provides a list of VCS remote cluster states and their descriptions.

Table C-1 VCS state definitions

State	Definition
INIT	The initial state of the cluster. This is the default state.

Table C-1 VCS state definitions (*continued*)

State	Definition
BUILD	The local cluster is receiving the initial snapshot from the remote cluster.
RUNNING	Indicates the remote cluster is running and connected to the local cluster.
LOST_HB	The connector process on the local cluster is not receiving heartbeats from the remote cluster
LOST_CONN	The connector process on the local cluster has lost the TCP/IP connection to the remote cluster.
UNKNOWN	The connector process on the local cluster determines the remote cluster is down, but another remote cluster sends a response indicating otherwise.
FAULTED	The remote cluster is down.
EXITING	The remote cluster is exiting gracefully.
EXITED	The remote cluster exited gracefully.
INQUIRY	The connector process on the local cluster is querying other clusters on which heartbeats were lost.
TRANSITIONING	The connector process on the remote cluster is failing over to another node in the cluster.

Examples of cluster state transitions

Following are examples of cluster state transitions:

- If a remote cluster joins the global cluster configuration, the other clusters in the configuration transition their "view" of the remote cluster to the RUNNING state:
INIT -> BUILD -> RUNNING
- If a cluster loses all heartbeats to a remote cluster in the RUNNING state, inquiries are sent. If all inquiry responses indicate the remote cluster is actually down, the cluster transitions the remote cluster state to FAULTED:
RUNNING -> LOST_HB -> INQUIRY -> FAULTED
- If at least one response does not indicate the cluster is down, the cluster transitions the remote cluster state to UNKNOWN:
RUNNING -> LOST_HB -> INQUIRY -> UNKNOWN
- When the ClusterService service group, which maintains the connector process as highly available, fails over to another system in the cluster, the remote clusters

transition their view of that cluster to TRANSITIONING, then back to RUNNING after the failover is successful:

RUNNING -> TRANSITIONING -> BUILD -> RUNNING

- When a remote cluster in a RUNNING state is stopped (by taking the ClusterService service group offline), the remote cluster transitions to EXITED: RUNNING -> EXITING -> EXITED

System states

Whenever the VCS engine is running on a system, it is in one of the states described in the table below. States indicate a system's current mode of operation. When the engine is started on a new system, it identifies the other systems available in the cluster and their states of operation. If a cluster system is in the state of RUNNING, the new system retrieves the configuration information from that system. Changes made to the configuration while it is being retrieved are applied to the new system before it enters the RUNNING state.

If no other systems are up and in the state of RUNNING or ADMIN_WAIT, and the new system has a configuration that is not invalid, the engine transitions to the state LOCAL_BUILD, and builds the configuration from disk. If the configuration is invalid, the system transitions to the state of STALE_ADMIN_WAIT.

See [“Examples of system state transitions”](#) on page 762.

[Table C-2](#) provides a list of VCS system states and their descriptions.

Table C-2 VCS system states

State	Definition
ADMIN_WAIT	<p>The running configuration was lost. A system transitions into this state for the following reasons:</p> <ul style="list-style-type: none"> ■ The last system in the RUNNING configuration leaves the cluster before another system takes a snapshot of its configuration and transitions to the RUNNING state. ■ A system in LOCAL_BUILD state tries to build the configuration from disk and receives an unexpected error from hacf indicating the configuration is invalid.
CURRENT_DISCOVER_WAIT	<p>The system has joined the cluster and its configuration file is valid. The system is waiting for information from other systems before it determines how to transition to another state.</p>

Table C-2 VCS system states (*continued*)

State	Definition
CURRENT_PEER_WAIT	The system has a valid configuration file and another system is doing a build from disk (LOCAL_BUILD). When its peer finishes the build, this system transitions to the state REMOTE_BUILD.
EXITING	The system is leaving the cluster.
EXITED	The system has left the cluster.
EXITING_FORCIBLY	An <code>hastop -force</code> command has forced the system to leave the cluster.
FAULTED	The system has left the cluster unexpectedly.
INITING	The system has joined the cluster. This is the initial state for all systems.
LEAVING	The system is leaving the cluster gracefully. When the agents have been stopped, and when the current configuration is written to disk, the system transitions to EXITING.
LOCAL_BUILD	The system is building the running configuration from the disk configuration.
REMOTE_BUILD	The system is building a running configuration that it obtained from a peer in a RUNNING state.
RUNNING	The system is an active member of the cluster.
STALE_ADMIN_WAIT	The system has an invalid configuration and there is no other system in the state of RUNNING from which to retrieve a configuration. If a system with a valid configuration is started, that system enters the LOCAL_BUILD state. Systems in STALE_ADMIN_WAIT transition to STALE_PEER_WAIT.
STALE_DISCOVER_WAIT	The system has joined the cluster with an invalid configuration file. It is waiting for information from any of its peers before determining how to transition to another state.
STALE_PEER_WAIT	The system has an invalid configuration file and another system is doing a build from disk (LOCAL_BUILD). When its peer finishes the build, this system transitions to the state REMOTE_BUILD.
UNKNOWN	The system has not joined the cluster because it does not have a system entry in the configuration.

Examples of system state transitions

Following are examples of system state transitions:

- If VCS is started on a system, and if that system is the only one in the cluster with a valid configuration, the system transitions to the RUNNING state:
INITING -> CURRENT_DISCOVER_WAIT -> LOCAL_BUILD -> RUNNING
- If VCS is started on a system with a valid configuration file, and if at least one other system is already in the RUNNING state, the new system transitions to the RUNNING state:
INITING -> CURRENT_DISCOVER_WAIT -> REMOTE_BUILD -> RUNNING
- If VCS is started on a system with an invalid configuration file, and if at least one other system is already in the RUNNING state, the new system transitions to the RUNNING state:
INITING -> STALE_DISCOVER_WAIT -> REMOTE_BUILD -> RUNNING
- If VCS is started on a system with an invalid configuration file, and if all other systems are in STALE_ADMIN_WAIT state, the system transitions to the STALE_ADMIN_WAIT state as shown below. A system stays in this state until another system with a valid configuration file is started.
INITING -> STALE_DISCOVER_WAIT -> STALE_ADMIN_WAIT
- If VCS is started on a system with a valid configuration file, and if other systems are in the ADMIN_WAIT state, the new system transitions to the ADMIN_WAIT state.
INITING -> CURRENT_DISCOVER_WAIT -> ADMIN_WAIT
- If VCS is started on a system with an invalid configuration file, and if other systems are in the ADMIN_WAIT state, the new system transitions to the ADMIN_WAIT state.
INITING -> STALE_DISCOVER_WAIT -> ADMIN_WAIT
- When a system in RUNNING state is stopped with the `hastop` command, it transitions to the EXITED state as shown below. During the LEAVING state, any online system resources are taken offline. When all of the system's resources are taken offline and the agents are stopped, the system transitions to the EXITING state, then EXITED.
RUNNING -> LEAVING -> EXITING -> EXITED

VCS attributes

This appendix includes the following topics:

- [About attributes and their definitions](#)
- [Resource attributes](#)
- [Resource type attributes](#)
- [Service group attributes](#)
- [System attributes](#)
- [Cluster attributes](#)
- [Heartbeat attributes \(for global clusters\)](#)
- [Remote cluster attributes](#)
- [Site attributes](#)

About attributes and their definitions

In addition to the attributes listed in this appendix, see the *Cluster Server Agent Developer's Guide*.

You can modify the values of attributes labelled user-defined from the command line or graphical user interface, or by manually modifying the `main.cf` configuration file. You can change the default values to better suit your environment and enhance performance.

When changing the values of attributes, be aware that VCS attributes interact with each other. After changing the value of an attribute, observe the cluster systems to confirm that unexpected behavior does not impair performance.

The values of attributes labelled system use only are set by VCS and are read-only. They contain important information about the state of the cluster.

The values labeled agent-defined are set by the corresponding agent and are also read-only.

Attribute values are case-sensitive.

See [“About VCS attributes”](#) on page 69.

Resource attributes

[Table D-1](#) lists resource attributes.

Table D-1 Resource attributes

Resource attributes	Description
ArgListValues (agent-defined)	<p>List of arguments passed to the resource’s agent on each system. This attribute is resource-specific and system-specific, meaning that the list of values passed to the agent depend on which system and resource they are intended.</p> <p>The number of values in the ArgListValues should not exceed 425. This requirement becomes a consideration if an attribute in the ArgList is a keylist, a vector, or an association. Such type of non-scalar attributes can typically take any number of values, and when they appear in the ArgList, the agent has to compute ArgListValues from the value of such attributes. If the non-scalar attribute contains many values, it will increase the size of ArgListValues. Hence when developing an agent, this consideration should be kept in mind when adding a non-scalar attribute in the ArgList. Users of the agent need to be notified that the attribute should not be configured to be so large that it pushes that number of values in the ArgListValues attribute to be more than 425.</p> <ul style="list-style-type: none">■ Type and dimension: string-vector■ Default: non-applicable.

Table D-1 Resource attributes (continued)

Resource attributes	Description
AutoStart (user-defined)	<p>Indicates if a resource should be brought online as part of a service group online, or if it needs the <code>hares -online</code> command.</p> <p>For example, you have two resources, R1 and R2. R1 and R2 are in group G1. R1 has an AutoStart value of 0, R2 has an AutoStart value of 1.</p> <p>In this case, you see the following effects:</p> <pre># hagr -online G1 -sys sys1</pre> <p>Brings only R2 to an ONLINE state. The group state is ONLINE and not a PARTIAL state. R1 remains OFFLINE.</p> <pre># hares -online R1 -sys sys1</pre> <p>Brings R1 online, the group state is ONLINE.</p> <pre># hares -offline R2 -sys sys1</pre> <p>Brings R2 offline, the group state is PARTIAL.</p> <p>Resources with a value of zero for AutoStart, contribute to the group's state only in their ONLINE state and not for their OFFLINE state.</p> <ul style="list-style-type: none"> ■ Type and dimension: boolean-scalar ■ Default: 1
ComputeStats (user-defined)	<p>Indicates to agent framework whether or not to calculate the resource's monitor statistics.</p> <ul style="list-style-type: none"> ■ Type and dimension: boolean-scalar ■ Default: 0
ConfidenceLevel (agent-defined)	<p>Indicates the level of confidence in an online resource. Values range from 0–100. Note that some VCS agents may not take advantage of this attribute and may always set it to 0. Set the level to 100 if the attribute is not used.</p> <ul style="list-style-type: none"> ■ Type and dimension: integer-scalar ■ Default: 0
Critical (user-defined)	<p>Indicates whether a fault of this resource should trigger a failover of the entire group or not. If Critical is 0 and no parent above has Critical = 1, then the resource fault will not cause group failover.</p> <ul style="list-style-type: none"> ■ Type and dimension: boolean-scalar ■ Default: 1

Table D-1 Resource attributes (*continued*)

Resource attributes	Description
<p>Enabled (user-defined)</p>	<p>Indicates agents monitor the resource.</p> <p>If a resource is created dynamically while VCS is running, you must enable the resource before VCS monitors it. For more information on how to add or enable resources, see the chapters on administering VCS from the command line and graphical user interfaces.</p> <p>When Enabled is set to 0, it implies a disabled resource.</p> <p>See “Troubleshooting VCS startup” on page 709.</p> <ul style="list-style-type: none"> ■ Type and dimension: boolean-scalar ■ Default: If you specify the resource in main.cf prior to starting VCS, the default value for this attribute is 1, otherwise it is 0.
<p>Flags (system use only)</p>	<p>Provides additional information for the state of a resource. Primarily this attribute raises flags pertaining to the resource. Values:</p> <p>ADMIN WAIT—The running configuration of a system is lost.</p> <p>RESTARTING —The agent is attempting to restart the resource because the resource was detected as offline in latest monitor cycle unexpectedly. See RestartLimit attribute for more information.</p> <p>STATE UNKNOWN—The latest monitor call by the agent could not determine if the resource was online or offline.</p> <p>MONITOR TIMEDOUT —The latest monitor call by the agent was terminated because it exceeded the maximum time specified by the static attribute MonitorTimeout.</p> <p>UNABLE TO OFFLINE—The agent attempted to offline the resource but the resource did not go offline. This flag is also set when a resource faults and the clean function completes successfully, but the subsequent monitor hangs or is unable to determine resource status.</p> <ul style="list-style-type: none"> ■ Type and dimension: integer-scalar ■ Default: Not applicable.
<p>Group (system use only)</p>	<p>String name of the service group to which the resource belongs.</p> <ul style="list-style-type: none"> ■ Type and dimension: string-scalar ■ Default: Not applicable.

Table D-1 Resource attributes (*continued*)

Resource attributes	Description
<p>IState (system use only)</p>	<p>The internal state of a resource. In addition to the State attribute, this attribute shows to which state the resource is transitioning. Values:</p> <p>NOT WAITING—Resource is not in transition.</p> <p>WAITING TO GO ONLINE—Agent notified to bring the resource online but procedure not yet complete.</p> <p>WAITING FOR CHILDREN ONLINE—Resource to be brought online, but resource depends on at least one offline resource. Resource transitions to waiting to go online when all children are online.</p> <p>WAITING TO GO OFFLINE—Agent notified to take the resource offline but procedure not yet complete.</p> <p>WAITING TO GO OFFLINE (propagate)—Same as above, but when completed the resource's children will also be offline.</p> <p>WAITING TO GO ONLINE (reverse)—Resource waiting to be brought online, but when it is online it attempts to go offline. Typically this is the result of issuing an offline command while resource was waiting to go online.</p> <p>WAITING TO GO OFFLINE (path) - Agent notified to take the resource offline but procedure not yet complete. When the procedure completes, the resource's children which are a member of the path in the dependency tree will also be offline.</p> <p>WAITING TO GO OFFLINE (reverse) - Resource waiting to be brought offline, but when it is offline it attempts to go online. Typically this is the result of issuing an online command while resource was waiting to go offline.</p> <p>WAITING TO GO ONLINE (reverse/path) - Resource waiting to be brought online, but when online it is brought offline. Resource transitions to WAITING TO GO OFFLINE (path). Typically this is the result of fault of a child resource while resource was waiting to go online.</p> <p>WAITING FOR PARENT OFFLINE – Resource waiting for parent resource to go offline. When parent is offline the resource is brought offline.</p> <p>Note: Although this attribute accepts integer types, the command line indicates the text representations.</p>

Table D-1 Resource attributes (*continued*)

Resource attributes	Description
<p>IState (system use only)</p>	<p>WAITING TO GO ONLINE (reverse/propagate)—Same as above, but resource propagates the offline operation.</p> <p>IStates on the source system for migration operations:</p> <ul style="list-style-type: none"> ■ WAITING FOR OFFLINE VALIDATION (migrate) – This state is applicable for resource on source system and indicates that migration operation has been accepted and VCS is validating whether migration is possible. ■ WAITING FOR MIGRATION OFFLINE – This state is applicable for resource on source system and indicates that migration operation has passed the prerequisite checks and validations on the source system. ■ WAITING TO COMPLETE MIGRATION – This state is applicable for resource on source system and indicates that migration process is complete on the source system and the VCS engine is waiting for the resource to come online on target system. <p>IStates on the target system for migration operations:</p> <ul style="list-style-type: none"> ■ WAITING FOR ONLINE VALIDATION (migrate) – This state is applicable for resource on target system and indicates that migration operations are accepted and VCS is validating whether migration is possible. ■ WAITING FOR MIGRATION ONLINE – This state is applicable for resource on target system and indicates that migration operation has passed the prerequisite checks and validations on the source system. ■ WAITING TO COMPLETE MIGRATION (online) – This state is applicable for resource on target system and indicates that migration process is complete on the source system and the VCS engine is waiting for the resource to come online on target system. ■ Type and dimension: integer-scalar ■ Default: 1 <p>NOT WAITING</p>
<p>LastOnline (system use only)</p>	<p>Indicates the system name on which the resource was last online. This attribute is set by VCS.</p> <ul style="list-style-type: none"> ■ Type and dimension: string-scalar ■ Default: Not applicable

Table D-1 Resource attributes (continued)

Resource attributes	Description
ManageFaults (user-defined)	<p>Specifies whether VCS responds to a resource fault by calling the Clean entry point. Its value supersedes all the values assigned to the attribute at service group level.</p> <p>This attribute can take the following values:</p> <ul style="list-style-type: none"> ■ ACT: VCS invokes the Clean function with <code>CleanReason</code> set to Online Hung. ■ IGNORE: VCS changes the resource state to <code>ONLINE ADMIN_WAIT</code>. ■ NULL (Blank): VCS takes action based on the values set for the attribute at the service group level. <p>Default value: ""</p>
MonitorMethod (system use only)	<p>Specifies the monitoring method that the agent uses to monitor the resource:</p> <ul style="list-style-type: none"> ■ Traditional—Poll-based resource monitoring ■ IMF—Intelligent resource monitoring <p>See “About resource monitoring” on page 40.</p> <p>Type and dimension: string-scalar</p> <p>Default: Traditional</p>
MonitorOnly (system use only)	<p>Indicates if the resource can be brought online or taken offline. If set to 0, resource can be brought online or taken offline. If set to 1, resource can only be monitored.</p> <p>Note: This attribute can only be affected by the command <code>hagrp -freeze</code>.</p> <ul style="list-style-type: none"> ■ Type and dimension: boolean-scalar ■ Default: 0
MonitorTimeStats (system use only)	<p>Valid keys are Average and TS. Average is the average time taken by the monitor function over the last Frequency number of monitor cycles. TS is the timestamp indicating when the engine updated the resource’s Average value.</p> <ul style="list-style-type: none"> ■ Type and dimension: string-association ■ Default: Average = 0 TS = ""
Name (system use only)	<p>Contains the actual name of the resource.</p> <ul style="list-style-type: none"> ■ Type and dimension: string-scalar ■ Default: Not applicable.

Table D-1 Resource attributes (*continued*)

Resource attributes	Description
Path (system use only)	<p>Set to 1 to identify a resource as a member of a path in the dependency tree to be taken offline on a specific system after a resource faults.</p> <ul style="list-style-type: none"> ■ Type and dimension: boolean-scalar ■ Default: 0
Probed (system use only)	<p>Indicates whether the state of the resource has been determined by the agent by running the monitor function.</p> <ul style="list-style-type: none"> ■ Type and dimension: boolean-scalar ■ Default: 0
ResourceInfo (system use only)	<p>This attribute has three predefined keys: State: values are Valid, Invalid, or Stale. Msg: output of the info agent function of the resource on stdout by the agent framework. TS: timestamp indicating when the ResourceInfo attribute was updated by the agent framework</p> <ul style="list-style-type: none"> ■ Type and dimension: string-association ■ Default: State = Valid Msg = "" TS = ""
ResourceOwner (user-defined)	<p>This attribute is used for VCS email notification and logging. VCS sends email notification to the person that is designated in this attribute when events occur that are related to the resource. Note that while VCS logs most events, not all events trigger notifications. VCS also logs the owner name when certain events occur.</p> <p>Make sure to set the severity level at which you want notifications to be sent to ResourceOwner or to at least one recipient defined in the Smtprcipients attribute of the NotifierMgr agent.</p> <ul style="list-style-type: none"> ■ Type and dimension: string-scalar ■ Default: "" ■ Example: "jdoe@example.com"
ResourceRecipients (user-defined)	<p>This attribute is used for VCS email notification. VCS sends email notification to persons designated in this attribute when events related to the resource occur and when the event's severity level is equal to or greater than the level specified in the attribute.</p> <p>Make sure to set the severity level at which you want notifications to be sent to ResourceRecipients or to at least one recipient defined in the Smtprcipients attribute of the NotifierMgr agent.</p> <ul style="list-style-type: none"> ■ Type and dimension: string-association ■ email id: The e-mail address of the person registered as a recipient for notification. ■ severity: The minimum level of severity at which notifications must be sent.

Table D-1 Resource attributes (*continued*)

Resource attributes	Description
Signaled (system use only)	Indicates whether a resource has been traversed. Used when bringing a service group online or taking it offline. <ul style="list-style-type: none"> ■ Type and dimension: integer-association ■ Default: Not applicable.
Start (system use only)	Indicates whether a resource was started (the process of bringing it online was initiated) on a system. <ul style="list-style-type: none"> ■ Type and dimension: integer -scalar ■ Default: 0
State (system use only)	Resource state displays the state of the resource and the flags associated with the resource. (Flags are also captured by the Flags attribute.) This attribute and Flags present a comprehensive view of the resource's current state. Values: ONLINE OFFLINE FAULTED OFFLINE MONITOR TIMEDOUT OFFLINE STATE UNKNOWN OFFLINE ADMIN WAIT ONLINE RESTARTING ONLINE MONITOR TIMEDOUT ONLINE STATE UNKNOWN ONLINE UNABLE TO OFFLINE ONLINE ADMIN WAIT FAULTED MONITOR TIMEDOUT FAULTED STATE UNKNOWN A FAULTED resource is physically offline, though unintentionally. Note: Although this attribute accepts integer types, the command line indicates the text representations. Type and dimension: integer -scalar Default: 0

Table D-1 Resource attributes (continued)

Resource attributes	Description
TriggerEvent (user-defined)	<p>A flag that turns Events on or off.</p> <ul style="list-style-type: none"> ■ Type and dimension: boolean-scalar ■ Default: 0
TriggerPath (user-defined)	<p>Enables you to customize the trigger path.</p> <ul style="list-style-type: none"> ■ Type and dimension: string-scalar ■ Default: "" <p>If a trigger is enabled but the trigger path at the service group level and at the resource level is "" (default), VCS invokes the trigger from the \$VCS_HOME/bin/triggers directory.</p> <p>The TriggerPath value is case-sensitive. VCS does not trim the leading spaces or trailing spaces in the Trigger Path value. If the path contains leading spaces or trailing spaces, the trigger might fail to get executed. The path that you specify is relative to \$VCS_HOME and the trigger path defined for the service group.</p> <p>Specify the path in the following format:</p> <p><i>ServiceGroupTriggerPath/Resource/Trigger</i></p> <p>If TriggerPath for service group sg1 is mytriggers/sg1 and TriggerPath for resource res1 is "", you must store the trigger script in the \$VCS_HOME/mytriggers/sg1/res1 directory. For example, store the resstatechange trigger script in the \$VCS_HOME/mytriggers/sg1/res1 directory. You can manage triggers for all resources for a service group more easily.</p> <p>If TriggerPath for resource res1 is mytriggers/sg1/vip1 in the preceding example, you must store the trigger script in the \$VCS_HOME/mytriggers/sg1/vip1 directory. For example, store the resstatechange trigger script in the \$VCS_HOME/mytriggers/sg1/vip1 directory.</p> <p>Modification of TriggerPath value at the resource level does not change the TriggerPath value at the service group level. Likewise, modification of TriggerPath value at the service group level does not change the TriggerPath value at the resource level.</p>
TriggerResRestart (user-defined)	<p>Determines whether or not to invoke the resrestart trigger if resource restarts.</p> <p>See “About the resrestart event trigger” on page 524.</p> <p>If this attribute is enabled at the group level, the resrestart trigger is invoked irrespective of the value of this attribute at the resource level.</p> <p>See “Service group attributes” on page 789.</p> <ul style="list-style-type: none"> ■ Type and dimension: boolean-scalar ■ Default: 0 (disabled)

Table D-1 Resource attributes (continued)

Resource attributes	Description
TriggerResStateChange (user-defined)	<p>Determines whether or not to invoke the resstatechange trigger if the resource changes state. See “About the resstatechange event trigger” on page 525.</p> <p>If this attribute is enabled at the group level, then the resstatechange trigger is invoked irrespective of the value of this attribute at the resource level.</p> <p>See “Service group attributes” on page 789.</p> <ul style="list-style-type: none"> ■ Type and dimension: boolean-scalar ■ Default: 0 (disabled)
TriggersEnabled (user-defined)	<p>Determines if a specific trigger is enabled or not.</p> <p>Triggers are disabled by default. You can enable specific triggers on all nodes or only on selected nodes. Valid values are RESFAULT, RESNOTOFF, RESSTATECHANGE, RESRESTART, and RESADMINWAIT.</p> <p>To enable triggers on a specific node, add trigger keys in the following format:</p> <pre>TriggersEnabled@node1 = {RESADMINWAIT, RESNOTOFF}</pre> <p>The resadminwait trigger and resnotoff trigger are enabled on node1.</p> <p>To enable triggers on all nodes in the cluster, add trigger keys in the following format:</p> <pre>TriggersEnabled = {RESADMINWAIT, RESNOTOFF}</pre> <p>The resadminwait trigger and resnotoff trigger are enabled on all nodes.</p> <ul style="list-style-type: none"> ■ Type and dimension: string-keylist ■ Default: {}

Resource type attributes

You can override some static attributes for resource types.

See [“Overriding resource type static attributes”](#) on page 151.

For more information on any attribute listed below, see the chapter on setting agent parameters in the *Cluster Server Agent Developer’s Guide*.

[Table D-2](#) lists the resource type attributes.

Table D-2 Resource type attributes

Resource type attributes	Description
ActionTimeout (user-defined)	Timeout value for the Action function. <ul style="list-style-type: none"> ■ Type and dimension: integer-scalar ■ Default: 30 seconds
AdvDbg (user-defined)	Enables activation of advanced debugging: <ul style="list-style-type: none"> ■ Type and dimension: string-keylist ■ Default: Not applicable For information about the AdvDbg attribute, see the <i>Cluster Server Agent Developer's Guide</i> .
AgentClass (user-defined)	Indicates the scheduling class for the VCS agent process. Use only one of the following sets of attributes to configure scheduling class and priority for VCS: <ul style="list-style-type: none"> ■ AgentClass, AgentPriority, ScriptClass, and ScriptPriority Or ■ OnlineClass, OnlinePriority, EPClass, and EPPriority ■ Type and dimension: string-scalar ■ Default: TS
AgentDirectory (user-defined)	Complete path of the directory in which the agent binary and scripts are located. Agents look for binaries and scripts in the following directories: <ul style="list-style-type: none"> ■ Directory specified by the AgentDirectory attribute ■ /opt/VRTSvc/bin/type/ ■ /opt/VRTSagents/ha/bin/type/ If none of the above directories exist, the agent does not start. Use this attribute in conjunction with the AgentFile attribute to specify a different location or different binary for the agent. <ul style="list-style-type: none"> ■ Type and dimension: string-scalar ■ Default = ""
AgentFailedOn (system use only)	A list of systems on which the agent for the resource type has failed. <ul style="list-style-type: none"> ■ Type and dimension: string-keylist ■ Default: Not applicable.

Table D-2 Resource type attributes (*continued*)

Resource type attributes	Description
AgentFile (user-defined)	Complete name and path of the binary for an agent. If you do not specify a value for this attribute, VCS uses the agent binary at the path defined by the AgentDirectory attribute. <ul style="list-style-type: none"> ■ Type and dimension: string-scalar ■ Default = ""
AgentPriority (user-defined)	Indicates the priority in which the agent process runs. Use only one of the following sets of attributes to configure scheduling class and priority for VCS: <ul style="list-style-type: none"> ■ AgentClass, AgentPriority, ScriptClass, and ScriptPriority Or ■ OnlineClass, OnlinePriority, EPClass, and EPPriority Type and dimension: string-scalar Default: 0
AgentReplyTimeout (user-defined)	The number of seconds the engine waits to receive a heartbeat from the agent before restarting the agent. <ul style="list-style-type: none"> ■ Type and dimension: integer-scalar ■ Default: 130 seconds
AgentStartTimeout (user-defined)	The number of seconds after starting the agent that the engine waits for the initial agent "handshake" before restarting the agent. <ul style="list-style-type: none"> ■ Type and dimension: integer-scalar ■ Default: 60 seconds

Table D-2 Resource type attributes (*continued*)

Resource type attributes	Description
<p>AlertOnMonitorTimeouts (user-defined)</p> <p>Note: This attribute can be overridden.</p>	<p>When a monitor times out as many times as the value or a multiple of the value specified by this attribute, then VCS sends an SNMP notification to the user. If this attribute is set to a value, say N, then after sending the notification at the first monitor timeout, VCS also sends an SNMP notification at each N-consecutive monitor timeout including the first monitor timeout for the second-time notification.</p> <p>When AlertOnMonitorTimeouts is set to 0, VCS will send an SNMP notification to the user only for the first monitor timeout; VCS will not send further notifications to the user for subsequent monitor timeouts until the monitor returns a success.</p> <p>The AlertOnMonitorTimeouts attribute can be used in conjunction with the FaultOnMonitorTimeouts attribute to control the behavior of resources of a group configured under VCS in case of monitor timeouts. When FaultOnMonitorTimeouts is set to 0 and AlertOnMonitorTimeouts is set to some value for all resources of a service group, then VCS will not perform any action on monitor timeouts for resources configured under that service group, but will only send notifications at the frequency set in the AlertOnMonitorTimeouts attribute.</p> <ul style="list-style-type: none"> ■ Type and dimension: integer-scalar ■ Default: 0
<p>ArgList (user-defined)</p>	<p>An ordered list of attributes whose values are passed to the open, close, online, offline, monitor, clean, info, and action functions.</p> <ul style="list-style-type: none"> ■ Type and dimension: string-vector ■ Default: Not applicable.
<p>AttrChangedTimeout (user-defined)</p> <p>Note: This attribute can be overridden.</p>	<p>Maximum time (in seconds) within which the attr_changed function must complete or be terminated.</p> <ul style="list-style-type: none"> ■ Type and dimension: integer-scalar ■ Default: 60 seconds
<p>CleanRetryLimit (user-defined)</p>	<p>Number of times to retry the clean function before moving a resource to ADMIN_WAIT state. If set to 0, clean is re-tried indefinitely.</p> <p>The valid values of this attribute are in the range of 0-1024.</p> <ul style="list-style-type: none"> ■ Type and dimension: integer-scalar ■ Default: 0
<p>CleanTimeout (user-defined)</p> <p>Note: This attribute can be overridden.</p>	<p>Maximum time (in seconds) within which the clean function must complete or else be terminated.</p> <ul style="list-style-type: none"> ■ Type and dimension: integer-scalar ■ Default: 60 seconds

Table D-2 Resource type attributes (*continued*)

Resource type attributes	Description
<p>CloseTimeout (user-defined)</p> <p>Note: This attribute can be overridden.</p>	<p>Maximum time (in seconds) within which the close function must complete or else be terminated.</p> <ul style="list-style-type: none"> ■ Type and dimension: integer-scalar ■ Default: 60 seconds
<p>ConflInterval (user-defined)</p> <p>Note: This attribute can be overridden.</p>	<p>When a resource has remained online for the specified time (in seconds), previous faults and restart attempts are ignored by the agent. (See ToleranceLimit and RestartLimit attributes for details.)</p> <ul style="list-style-type: none"> ■ Type and dimension: integer-scalar ■ Default: 600 seconds
<p>ContainerOpts (system use only)</p>	<p>Specifies information that passes to the agent that controls the resources. These values are only effective when you set the ContainerInfo service group attribute.</p> <ul style="list-style-type: none"> ■ RunInContainer When the value of the RunInContainer key is 1, the agent function (entry point) for that resource runs inside of the local container. When the value of the RunInContainer key is 0, the agent function (entry point) for that resource runs outside the local container (in the global environment). ■ PassCInfo When the value of the PassCInfo key is 1, the agent function receives the container information that is defined in the service group's ContainerInfo attribute. An example use of this value is to pass the name of the container to the agent. When the value of the PassCInfo key is 0, the agent function does not receive the container information that is defined in the service group's ContainerInfo attribute.
<p>EPClass (user-defined)</p>	<p>Enables you to control the scheduling class for the agent functions (entry points) other than the online entry point whether the entry point is in C or scripts.</p> <p>The following values are valid for this attribute:</p> <ul style="list-style-type: none"> ■ RT (Real Time) ■ TS (Time Sharing) ■ -1—indicates that VCS does not use this attribute to control the scheduling class of entry points. <p>Use only one of the following sets of attributes to configure scheduling class and priority for VCS:</p> <ul style="list-style-type: none"> ■ AgentClass, AgentPriority, ScriptClass, and ScriptPriority Or ■ OnlineClass, OnlinePriority, EPClass, and EPPriority ■ Type and dimension: string-scalar ■ Default: -1

Table D-2 Resource type attributes (*continued*)

Resource type attributes	Description
<p>EPPriority (user-defined)</p>	<p>Enables you to control the scheduling priority for the agent functions (entry points) other than the online entry point. The attribute controls the agent function priority whether the entry point is in C or scripts.</p> <p>The following values are valid for this attribute:</p> <ul style="list-style-type: none"> ■ 0—indicates the default priority value for the configured scheduling class as given by the EPClass attribute for the operating system. ■ Greater than 0—indicates a value greater than the default priority for the operating system. Veritas recommends a value of greater than 0 for this attribute. A system that has a higher load requires a greater value. ■ -1—indicates that VCS does not use this attribute to control the scheduling priority of entry points. <p>Use only one of the following sets of attributes to configure scheduling class and priority for VCS:</p> <ul style="list-style-type: none"> ■ AgentClass, AgentPriority, ScriptClass, and ScriptPriority Or ■ OnlineClass, OnlinePriority, EPClass, and EPPriority ■ Type and dimension: string-scalar ■ Default: -1
<p>ExternalStateChange (user-defined)</p> <p>Note: This attribute can be overridden.</p>	<p>Defines how VCS handles service group state when resources are intentionally brought online or taken offline outside of VCS control.</p> <p>The attribute can take the following values:</p> <p>OnlineGroup: If the configured application is started outside of VCS control, VCS brings the corresponding service group online.</p> <p>OfflineGroup: If the configured application is stopped outside of VCS control, VCS takes the corresponding service group offline.</p> <p>OfflineHold: If a configured application is stopped outside of VCS control, VCS sets the state of the corresponding VCS resource as offline. VCS does not take any parent resources or the service group offline.</p> <p>OfflineHold and OfflineGroup are mutually exclusive.</p>

Table D-2 Resource type attributes (*continued*)

Resource type attributes	Description
<p>FaultOnMonitorTimeouts (user-defined)</p> <p>Note: This attribute can be overridden.</p>	<p>When a monitor times out as many times as the value specified, the corresponding resource is brought down by calling the clean function. The resource is then marked FAULTED, or it is restarted, depending on the value set in the RestartLimit attribute.</p> <p>When FaultOnMonitorTimeouts is set to 0, monitor failures are not considered indicative of a resource fault. A low value may lead to spurious resource faults, especially on heavily loaded systems.</p> <ul style="list-style-type: none"> ■ Type and dimension: integer-scalar ■ Default: 4
<p>FaultPropagation (user-defined)</p> <p>Note: This attribute can be overridden.</p>	<p>Specifies if VCS should propagate the fault up to parent resources and take the entire service group offline when a resource faults.</p> <p>The value 1 indicates that when a resource faults, VCS fails over the service group, if the group's AutoFailOver attribute is set to 1. The value 0 indicates that when a resource faults, VCS does not take other resources offline, regardless of the value of the Critical attribute. The service group does not fail over on resource fault.</p> <ul style="list-style-type: none"> ■ Type and dimension: boolean-scalar ■ Default: 1
<p>FireDrill (user-defined)</p>	<p>Specifies whether or not fire drill is enabled for the resource type. If the value is:</p> <ul style="list-style-type: none"> ■ 0: Fire drill is disabled. ■ 1: Fire drill is enabled. <p>You can override this attribute.</p> <ul style="list-style-type: none"> ■ Type and dimension: boolean-scalar ■ Default: 0

Table D-2 Resource type attributes (*continued*)

Resource type attributes	Description
<p>IMF (user-defined)</p> <p>Note: This attribute can be overridden.</p>	<p>Determines whether the IMF-aware agent must perform intelligent resource monitoring. You can also override the value of this attribute at resource-level.</p> <p>Type and dimension: integer-association</p> <p>This attribute includes the following keys:</p> <ul style="list-style-type: none"> ■ Mode Define this attribute to enable or disable intelligent resource monitoring. Valid values are as follows: <ul style="list-style-type: none"> ■ 0—Does not perform intelligent resource monitoring ■ 1—Performs intelligent resource monitoring for offline resources and performs poll-based monitoring for online resources ■ 2—Performs intelligent resource monitoring for online resources and performs poll-based monitoring for offline resources ■ 3—Performs intelligent resource monitoring for both online and for offline resources ■ MonitorFreq This key value specifies the frequency at which the agent invokes the monitor agent function. The value of this key is an integer. You can set this attribute to a non-zero value in some cases where the agent requires to perform poll-based resource monitoring in addition to the intelligent resource monitoring. See the <i>Cluster Server Bundled Agents Reference Guide</i> for agent-specific recommendations. After the resource registers with the IMF notification module, the agent calls the monitor agent function as follows: <ul style="list-style-type: none"> ■ After every (MonitorFreq x MonitorInterval) number of seconds for online resources ■ After every (MonitorFreq x OfflineMonitorInterval) number of seconds for offline resources ■ RegisterRetryLimit If you enable IMF, the agent invokes the imf_register agent function to register the resource with the IMF notification module. The value of the RegisterRetyLimit key determines the number of times the agent must retry registration for a resource. If the agent cannot register the resource within the limit that is specified, then intelligent monitoring is disabled until the resource state changes or the value of the Mode key changes.
<p>IMFRegList (user-defined)</p>	<p>An ordered list of attributes whose values are registered with the IMF notification module.</p> <ul style="list-style-type: none"> ■ Type and dimension: string-vector ■ Default: Not applicable.

Table D-2 Resource type attributes (*continued*)

Resource type attributes	Description
InfoInterval (user-defined)	<p>Duration (in seconds) after which the info function is invoked by the agent framework for ONLINE resources of the particular resource type.</p> <p>If set to 0, the agent framework does not periodically invoke the info function. To manually invoke the info function, use the command <code>hares -refreshinfo</code>. If the value you designate is 30, for example, the function is invoked every 30 seconds for all ONLINE resources of the particular resource type.</p> <ul style="list-style-type: none"> ■ Type and dimension: integer-scalar ■ Default: 0
IntentionalOffline (user-defined)	<p>Defines how VCS reacts when a configured application is intentionally stopped outside of VCS control.</p> <p>Add this attribute for agents that support detection of an intentional offline outside of VCS control. Note that the intentional offline feature is available for agents registered as V51 or later.</p> <p>The value 0 instructs the agent to register a fault and initiate the failover of a service group when the supported resource is taken offline outside of VCS control.</p> <p>The value 1 instructs VCS to take the resource offline when the corresponding application is stopped outside of VCS control.</p> <ul style="list-style-type: none"> ■ Type and dimension: boolean-scalar ■ Default: 0
InfoTimeout (user-defined)	<p>Timeout value for info function. If function does not complete by the designated time, the agent framework cancels the function's thread.</p> <ul style="list-style-type: none"> ■ Type and dimension: integer-scalar ■ Default: 30 seconds
LevelTwoMonitorFreq (user-defined)	<p>Specifies the frequency at which the agent for this resource type must perform second-level or detailed monitoring.</p> <p>Type and dimension: integer-scalar</p> <p>Default: 0</p>

Table D-2 Resource type attributes (*continued*)

Resource type attributes	Description
LogDbg (user-defined)	<p>Indicates the debug severities enabled for the resource type or agent framework. Debug severities used by the agent functions are in the range of DBG_1–DBG_21. The debug messages from the agent framework are logged with the severities DBG_AGINFO, DBG_AGDEBUG and DBG_AGTRACE, representing the least to most verbose.</p> <ul style="list-style-type: none">■ Type and dimension: string-keylist■ Default: {} (none) <p>The LogDbg attribute can be overridden. Using the LogDbg attribute, you can set DBG_AGINFO, DBG_AGTRACE, and DBG_AGDEBUG severities at the resource level, but it does not have an impact as these levels are agent-type specific. Veritas recommends to set values between DBG_1 to DBG_21 at resource level using the LogDbg attribute.</p>
LogFileSize (user-defined)	<p>Specifies the size (in bytes) of the agent log file. Minimum value is 64 KB. Maximum value is 134217728 bytes (128MB).</p> <ul style="list-style-type: none">■ Type and dimension: integer-scalar■ Default: 33554432 (32 MB)
LogViaHalog (user-defined)	<p>Enables the log of all the entry points to be logged either in the respective agent log file or the engine log file based on the values configured.</p> <ul style="list-style-type: none">■ 0: The agent's log goes into the respective agent log file.■ 1: The C/C++ entry point's logs goes into the agent log file and the script entry point's logs goes into the engine log file using the <code>halog</code> command. <p>Type: boolean-scalar Default: 0</p>

Table D-2 Resource type attributes (*continued*)

Resource type attributes	Description
MigrateWaitLimit (user-defined)	<p>Number of monitor intervals to wait for a resource to migrate after the migrating procedure is complete. MigrateWaitLimit is applicable for the source and target node because the migrate operation takes the resource offline on the source node and brings the resource online on the target node. You can also define MigrateWaitLimit as the number of monitor intervals to wait for the resource to go offline on the source node after completing the migrate procedure and the number of monitor intervals to wait for the resource to come online on the target node after resource is offline on the source node.</p> <ul style="list-style-type: none"> ■ Type and dimension: integer-scalar ■ Default: 2 <p>Note: This attribute can be overridden.</p> <p>Probes fired manually are counted when MigrateWaitLimit is set and the resource is waiting to migrate. For example, if the MigrateWaitLimit of a resource is set to 5 and the MonitorInterval is set to 60 (seconds), the resource waits for a maximum of five monitor intervals (that is, 5 x 60), and if all five monitors within MigrateWaitLimit report the resource as online on source node, it sets the ADMIN_WAIT flag. If you run another probe, the resource waits for four monitor intervals (that is, 4 x 60), and if the fourth monitor does not report the state as offline on source, it sets the ADMIN_WAIT flag. This procedure is repeated for 5 complete cycles. Similarly, if resource not moved to online state within the MigrateWaitLimit then it sets the ADMIN_WAIT flag.</p>
MigrateTimeout (user-defined)	<p>Maximum time (in seconds) within which the migrate procedure must complete or else be terminated.</p> <ul style="list-style-type: none"> ■ Type and dimension: integer-scalar ■ Default: 600 seconds <p>Note: This attribute can be overridden.</p>
MonitorInterval (user-defined) Note: This attribute can be overridden.	<p>Duration (in seconds) between two consecutive monitor calls for an ONLINE or transitioning resource.</p> <p>Note: Note: The value of this attribute for the MultiNICB type must be less than its value for the IPMultiNICB type. See the <i>Cluster Server Bundled Agents Reference Guide</i> for more information.</p> <p>A low value may impact performance if many resources of the same type exist. A high value may delay detection of a faulted resource.</p> <ul style="list-style-type: none"> ■ Type and dimension: integer-scalar ■ Default: 60 seconds

Table D-2 Resource type attributes (*continued*)

Resource type attributes	Description
<p>MonitorStatsParam (user-defined)</p>	<p>Stores the required parameter values for calculating monitor time statistics.</p> <pre>static str MonitorStatsParam = {Frequency = 10, ExpectedValue = 3000, ValueThreshold = 100, AvgThreshold = 40}</pre> <p>Frequency: The number of monitor cycles after which the average monitor cycle time should be computed and sent to the engine. If configured, the value for this attribute must be between 1 and 30. The value 0 indicates that the monitor cycle time should not be computed. Default=0.</p> <p>ExpectedValue: The expected monitor time in milliseconds for all resources of this type. Default=100.</p> <p>ValueThreshold: The acceptable percentage difference between the expected monitor cycle time (ExpectedValue) and the actual monitor cycle time. Default=100.</p> <p>AvgThreshold: The acceptable percentage difference between the benchmark average and the moving average of monitor cycle times. Default=40.</p> <ul style="list-style-type: none"> ■ Type and dimension: integer-association ■ Default: Different value for each parameter.
<p>MonitorTimeout (user-defined)</p> <p>Note: This attribute can be overridden.</p>	<p>Maximum time (in seconds) within which the monitor function must complete or else be terminated.</p> <ul style="list-style-type: none"> ■ Type and dimension: integer-scalar ■ Default: 60 seconds
<p>NumThreads (user-defined)</p>	<p>Number of threads used within the agent process for managing resources. This number does not include threads used for other internal purposes.</p> <p>If the number of resources being managed by the agent is less than or equal to the NumThreads value, only that many number of threads are created in the agent. Addition of more resources does not create more service threads. Similarly deletion of resources causes service threads to exit. Thus, setting NumThreads to 1 forces the agent to just use 1 service thread no matter what the resource count is. The agent framework limits the value of this attribute to 30.</p> <ul style="list-style-type: none"> ■ Type and dimension: integer-scalar ■ Default: 10
<p>OfflineMonitorInterval (user-defined)</p> <p>Note: This attribute can be overridden.</p>	<p>Duration (in seconds) between two consecutive monitor calls for an OFFLINE resource. If set to 0, OFFLINE resources are not monitored.</p> <ul style="list-style-type: none"> ■ Type and dimension: integer-scalar ■ Default: 300 seconds

Table D-2 Resource type attributes (*continued*)

Resource type attributes	Description
<p>OfflineTimeout (user-defined)</p> <p>Note: This attribute can be overridden.</p>	<p>Maximum time (in seconds) within which the offline function must complete or else be terminated.</p> <ul style="list-style-type: none"> ■ Type and dimension: integer-scalar ■ Default: 300 seconds
<p>OfflineWaitLimit (user-defined)</p> <p>Note: This attribute can be overridden.</p>	<p>Number of monitor intervals to wait for the resource to go offline after completing the offline procedure. Increase the value of this attribute if the resource is likely to take a longer time to go offline.</p> <p>Probes fired manually are counted when OfflineWaitLimit is set and the resource is waiting to go offline. For example, say the OfflineWaitLimit of a resource is set to 5 and the MonitorInterval is set to 60. The resource waits for a maximum of five monitor intervals (five times 60), and if all five monitors within OfflineWaitLimit report the resource as online, it calls the clean agent function. If the user fires a probe, the resource waits for four monitor intervals (four times 60), and if the fourth monitor does not report the state as offline, it calls the clean agent function. If the user fires another probe, one more monitor cycle is consumed and the resource waits for three monitor intervals (three times 60), and if the third monitor does not report the state as offline, it calls the clean agent function.</p> <ul style="list-style-type: none"> ■ Type and dimension: integer-scalar ■ Default: 0
<p>OnlineClass (user-defined)</p>	<p>Enables you to control the scheduling class for the online agent function (entry point). This attribute controls the class whether the entry point is in C or scripts.</p> <p>The following values are valid for this attribute:</p> <ul style="list-style-type: none"> ■ RT (Real Time) ■ TS (Time Sharing) ■ -1—indicates that VCS does not use this attribute to control the scheduling class of entry points. <p>Use only one of the following sets of attributes to configure scheduling class and priority for VCS:</p> <ul style="list-style-type: none"> ■ AgentClass, AgentPriority, ScriptClass, and ScriptPriority Or ■ OnlineClass, OnlinePriority, EPClass, and EPPriority ■ Type and dimension: string-scalar ■ Default: -1

Table D-2 Resource type attributes (*continued*)

Resource type attributes	Description
<p>OnlinePriority (user-defined)</p>	<p>Enables you to control the scheduling priority for the online agent function (entry point). This attribute controls the priority whether the entry point is in C or scripts.</p> <p>The following values are valid for this attribute:</p> <ul style="list-style-type: none"> ■ 0—indicates the default priority value for the configured scheduling class as given by the OnlineClass for the operating system. Veritas recommends that you set the value of the OnlinePriority attribute to 0. ■ Greater than 0—indicates a value greater than the default priority for the operating system. ■ -1—indicates that VCS does not use this attribute to control the scheduling priority of entry points. <p>Use only one of the following sets of attributes to configure scheduling class and priority for VCS:</p> <ul style="list-style-type: none"> ■ AgentClass, AgentPriority, ScriptClass, and ScriptPriority Or ■ OnlineClass, OnlinePriority, EPClass, and EPPriority <p>Type and dimension: string-scalar Default: -1</p>
<p>OnlineRetryLimit (user-defined)</p> <p>Note: This attribute can be overridden.</p>	<p>Number of times to retry the <code>online</code> operation if the attempt to online a resource is unsuccessful. This parameter is meaningful only if the clean operation is implemented.</p> <ul style="list-style-type: none"> ■ Type and dimension: integer-scalar ■ Default: 0
<p>OnlineTimeout (user-defined)</p> <p>Note: This attribute can be overridden.</p>	<p>Maximum time (in seconds) within which the online function must complete or else be terminated.</p> <ul style="list-style-type: none"> ■ Type and dimension: integer-scalar ■ Default: 300 seconds

Table D-2 Resource type attributes (*continued*)

Resource type attributes	Description
<p>OnlineWaitLimit (user-defined)</p> <p>Note: This attribute can be overridden.</p>	<p>Number of monitor intervals to wait for the resource to come online after completing the online procedure. Increase the value of this attribute if the resource is likely to take a longer time to come online.</p> <p>Each probe command fired from the user is considered as one monitor interval. For example, say the OnlineWaitLimit of a resource is set to 5. This means that the resource will be moved to a faulted state after five monitor intervals. If the user fires a probe, then the resource will be faulted after four monitor cycles, if the fourth monitor does not report the state as ONLINE. If the user again fires a probe, then one more monitor cycle is consumed and the resource will be faulted if the third monitor does not report the state as ONLINE.</p> <ul style="list-style-type: none"> ■ Type and dimension: integer-scalar ■ Default: 2
<p>OpenTimeout (user-defined)</p> <p>Note: This attribute can be overridden.</p>	<p>Maximum time (in seconds) within which the open function must complete or else be terminated.</p> <ul style="list-style-type: none"> ■ Type and dimension: integer-scalar ■ Default: 60 seconds
<p>Operations (user-defined)</p>	<p>Indicates valid operations for resources of the resource type. Values are OnOnly (can online only), OnOff (can online and offline), None (cannot online or offline).</p> <ul style="list-style-type: none"> ■ Type and dimension: string-scalar ■ Default: OnOff
<p>RestartLimit (user-defined)</p> <p>Note: This attribute can be overridden.</p>	<p>Number of times to retry bringing a resource online when it is taken offline unexpectedly and before VCS declares it FAULTED.</p> <ul style="list-style-type: none"> ■ Type and dimension: integer-scalar ■ Default: 0

Table D-2 Resource type attributes (*continued*)

Resource type attributes	Description
<p>ScriptClass (user-defined)</p>	<p>Indicates the scheduling class of the script processes (for example, online) created by the agent.</p> <p>Use only one of the following sets of attributes to configure scheduling class and priority for VCS:</p> <ul style="list-style-type: none"> ■ AgentClass, AgentPriority, ScriptClass, and ScriptPriority Or ■ OnlineClass, OnlinePriority, EPClass, and EPPriority ■ Type and dimension: string-scalar ■ Default: -1 ■ Type and dimension: string-scalar ■ Default: TS
<p>ScriptPriority (user-defined)</p>	<p>Indicates the priority of the script processes created by the agent.</p> <p>Use only one of the following sets of attributes to configure scheduling class and priority for VCS:</p> <ul style="list-style-type: none"> ■ AgentClass, AgentPriority, ScriptClass, and ScriptPriority Or ■ OnlineClass, OnlinePriority, EPClass, and EPPriority ■ Type and dimension: string-scalar ■ Default: 0
<p>SourceFile (user-defined)</p>	<p>File from which the configuration is read. Do not configure this attribute in main.cf.</p> <p>Make sure the path exists on all nodes before running a command that configures this attribute.</p> <ul style="list-style-type: none"> ■ Type and dimension: string-scalar ■ Default: .\types.cf
<p>SupportedActions (user-defined)</p>	<p>Valid action tokens for the resource type.</p> <ul style="list-style-type: none"> ■ Type and dimension: string-vector ■ Default: {}
<p>SupportedOperations (user-defined)</p>	<p>Indicates the additional operations for a resource type or an agent. Only <code>migrate</code> keyword is supported.</p> <ul style="list-style-type: none"> ■ Type and dimension: string-keylist ■ Default: {} <p>An example of a resource type that supports migration is a logical partition (LPAR).</p>

Table D-2 Resource type attributes (*continued*)

Resource type attributes	Description
<p>ToleranceLimit (user-defined)</p> <p>Note: This attribute can be overridden.</p>	<p>After a resource goes online, the number of times the monitor function should return OFFLINE before declaring the resource FAULTED.</p> <p>A large value could delay detection of a genuinely faulted resource.</p> <ul style="list-style-type: none"> Type and dimension: integer-scalar Default: 0
<p>TypeOwner (user-defined)</p>	<p>This attribute is used for VCS notification. VCS sends notifications to persons designated in this attribute when an event occurs related to the agent's resource type. If the agent of that type faults or restarts, VCS send notification to the TypeOwner. Note that while VCS logs most events, not all events trigger notifications.</p> <p>Make sure to set the severity level at which you want notifications to be sent to TypeOwner or to at least one recipient defined in the Smtprcipients attribute of the NotifierMngr agent.</p> <ul style="list-style-type: none"> Type and dimension: string-scalar Default: "" Example: "jdoe@example.com"
<p>TypeRecipients (user-defined)</p>	<p>The email-ids set in the TypeRecipients attribute receive email notification for events related to a specific agent. There are only two types of events related to an agent for which notifications are sent:</p> <ul style="list-style-type: none"> Agent fault - Warning Agent restart - Information

Service group attributes

[Table D-3](#) lists the service group attributes.

Table D-3 Service group attributes

Service Group Attributes	Definition
<p>ActiveCount (system use only)</p>	<p>Number of resources in a service group that are active (online or waiting to go online). When the number drops to zero, the service group is considered offline.</p> <ul style="list-style-type: none"> Type and dimension: integer-scalar Default: Not applicable.

Table D-3 Service group attributes (*continued*)

Service Group Attributes	Definition
AdministratorGroups (user-defined)	<p>List of operating system user account groups that have administrative privileges on the service group.</p> <p>This attribute applies to clusters running in secure mode.</p> <ul style="list-style-type: none"> ■ Type and dimension: string-keylist ■ Default: {} (none)
Administrators (user-defined)	<p>List of VCS users with privileges to administer the group.</p> <p>Note: A Group Administrator can perform all operations related to a specific service group, but cannot perform generic cluster operations.</p> <p>See “About VCS user privileges and roles” on page 82.</p> <ul style="list-style-type: none"> ■ Type and dimension: string-keylist ■ Default: {} (none)
Authority (user-defined)	<p>Indicates whether or not the local cluster is allowed to bring the service group online. If set to 0, it is not, if set to 1, it is. Only one cluster can have this attribute set to 1 for a specific global group.</p> <p>See “About serialization–The Authority attribute” on page 560.</p> <ul style="list-style-type: none"> ■ Type and dimension: integer-scalar ■ Default: 0
AutoClearCount (System use only)	<p>Indicates the number of attempts that the VCS engine made to clear the state of the service group that has faulted and does not have a failover target. This attribute is used only if the AutoClearLimit attribute is set for the service group.</p>
AutoClearInterval (user-defined)	<p>Indicates the interval in seconds after which a service group that has faulted and has no failover target is cleared automatically. The state of the service group is cleared only if AutoClearLimit is set to a non-zero value.</p> <p>Default: 0</p>
AutoclearLimit (user-defined)	<p>Defines the number of attempts to be made to clear the Faulted state of a service group. Disables the auto-clear feature when set to zero.</p>

Table D-3 Service group attributes (*continued*)

Service Group Attributes	Definition
<p>AutoDisabled (system use only)</p>	<p>Indicates that VCS does not know the status of a service group (or specified system for parallel service groups). This could occur because the group is not probed (on specified system for parallel groups) in the SystemList attribute. Or the VCS engine is not running on a node designated in the SystemList attribute, but the node is visible.</p> <p>When VCS does not know the status of a service group on a node but you want VCS to consider the service group enabled, perform this command to change the AutoDisabled value to 0.</p> <pre>hagrps -autoenable grp -sys sys1</pre> <p>This command instructs VCS that even though VCS has marked the service group auto-disabled, you are sure that the service group is not online on sys1. For failover service groups, this is important because the service groups now can be brought online on remaining nodes.</p> <ul style="list-style-type: none"> ■ Type and dimension: boolean-scalar ■ Default: 0
<p>AutoFailOver (user-defined)</p>	<p>Indicates whether VCS initiates an automatic failover if the service group faults.</p> <p>The attribute can take the following values:</p> <ul style="list-style-type: none"> ■ 0—VCS does not fail over the service group. ■ 1—VCS automatically fails over the service group if a suitable node exists for failover. ■ 2—VCS automatically fails over the service group only if a suitable node exists in the same system zone or sites where the service group was online. <p>To set the value as 2, you must have enabled HA/DR license and the service group must not be hybrid. If you have not defined system zones or sites, the failover behavior is similar to 1.</p> <p>See “ About controlling failover on service group or system faults” on page 422.</p> <ul style="list-style-type: none"> ■ Type and dimension: integer-scalar ■ Default: 1 (enabled)

Table D-3 Service group attributes (*continued*)

Service Group Attributes	Definition
AutoRestart (user-defined)	<p>Restarts a service group after a faulted persistent resource becomes online.</p> <p>The attribute can take the following values:</p> <ul style="list-style-type: none">■ 0—Autorestart is disabled.■ 1—Autorestart is enabled.■ 2—When a faulted persistent resource recovers from a fault, the VCS engine clears the faults on all non-persistent faulted resources on the system. It then restarts the service group. <p>See “About service group dependencies” on page 475.</p> <p>Note: This attribute applies only to service groups containing persistent resources.</p> <ul style="list-style-type: none">■ Type and dimension: integer-scalar■ Default: 1 (enabled)
AutoStart (user-defined)	<p>Designates whether a service group is automatically started when VCS is started.</p> <ul style="list-style-type: none">■ Type and dimension: boolean-scalar■ Default: 1 (enabled)
AutoStartIfPartial (user-defined)	<p>Indicates whether to initiate bringing a service group online if the group is probed and discovered to be in a PARTIAL state when VCS is started.</p> <ul style="list-style-type: none">■ Type and dimension: boolean-scalar■ Default: 1 (enabled)

Table D-3 Service group attributes (*continued*)

Service Group Attributes	Definition
AutoStartList (user-defined)	<p>List of systems on which, under specific conditions, the service group will be started with VCS (usually at system boot). For example, if a system is a member of a failover service group's AutoStartList attribute, and if the service group is not already running on another system in the cluster, the group is brought online when the system is started.</p> <p>VCS uses the AutoStartPolicy attribute to determine the system on which to bring the service group online.</p> <p>Note: For the service group to start, AutoStart must be enabled and Frozen must be 0. Also, beginning with 1.3.0, you must define the SystemList attribute prior to setting this attribute.</p> <ul style="list-style-type: none"> ■ Type and dimension: string-keylist ■ Default: {} (none)
AutoStartPolicy (user-defined)	<p>Sets the policy VCS uses to determine the system on which a service group is brought online during an autostart operation if multiple systems exist.</p> <p>This attribute has three options:</p> <p>Order (default)—Systems are chosen in the order in which they are defined in the AutoStartList attribute.</p> <p>Load—Systems are chosen in the order of their capacity, as designated in the AvailableCapacity system attribute. System with the highest capacity is chosen first.</p> <p>Note: You cannot set the value Load when the cluster attribute Statistics is set to Enabled.</p> <p>Priority—Systems are chosen in the order of their priority in the SystemList attribute. Systems with the lowest priority is chosen first.</p> <ul style="list-style-type: none"> ■ Type and dimension: string-scalar ■ Default: Order

Table D-3 Service group attributes (*continued*)

Service Group Attributes	Definition
CapacityReserved (system use only)	<p>Indicates whether capacity is reserved to bring service groups online or to fail them over. Capacity is reserved only when the service group attribute FailOverPolicy is set to BiggestAvailable.</p> <p>This attribute is localized.</p> <ul style="list-style-type: none"> ■ Type and dimension: Boolean ■ Default: "" <p>Possible values:</p> <p>1: Capacity is reserved.</p> <p>0: Capacity is not reserved.</p> <p>The value can be reset using the <code>hagrp -flush</code> command.</p> <p>To list this attribute, use the <code>-all</code> option with the <code>hagrp -display</code> command.</p>
ClusterFailOverPolicy (user-defined)	<p>Determines how a global service group behaves when a cluster faults or when a global group faults. The attribute can take the following values:</p> <p>Manual—The group does not fail over to another cluster automatically.</p> <p>Auto—The group fails over to another cluster automatically if it is unable to fail over within the local cluster, or if the entire cluster faults.</p> <p>Connected—The group fails over automatically to another cluster only if it is unable to fail over within the local cluster.</p> <ul style="list-style-type: none"> ■ Type and dimension: string-scalar ■ Default: Manual
ClusterList (user-defined)	<p>Specifies the list of clusters on which the service group is configured to run.</p> <ul style="list-style-type: none"> ■ Type and dimension: integer-association ■ Default: {} (none)

Table D-3 Service group attributes (*continued*)

Service Group Attributes	Definition
ContainerInfo (user-defined)	<p>Specifies if you can use the service group with the container. Assign the following values to the ContainerInfo attribute:</p> <ul style="list-style-type: none"> ■ Name: The name of the container. ■ Type: The type of container. You can set this to WPAR. ■ Enabled: Specify the value as 1 to enable the container. Specify the value as 0 to disable the container. Specify the value as 2 to enable failovers from physical computers to virtual machines and from virtual machines to physical computers. Refer to the <i>Veritas InfoScale 7.1 Virtualization Guide</i> for more information on use of value 2 for the Enabled key. <p>You can set a per-system value or a global value for this attribute.</p> <ul style="list-style-type: none"> ■ Type and dimension: string-scalar ■ Default: {} <p>You can change the attribute scope from local to global as follows:</p> <pre># hagrps -local <service_group_name> <attribute_name></pre> <p>You can change the attribute scope from global to local as follows:</p> <pre># hagrps -global <service_group_name> <attribute_name> <value> ... <key> ... {<key> <value>} ...</pre> <p>For more information about the <code>-local</code> option and the <code>-global</code> option, see the man pages associated with the <code>hagrps</code> command.</p>
CurrentCount (system use only)	<p>Number of systems on which the service group is active.</p> <ul style="list-style-type: none"> ■ Type and dimension: integer-scalar ■ Default: Not applicable.

Table D-3 Service group attributes (*continued*)

Service Group Attributes	Definition
DisableFaultMessages (user-defined)	<p>Suppresses fault and failover messages, for a group and its resources, from getting logged in the VCS engine log file. This attribute does not suppress the information messages getting logged in the log file.</p> <p>The attribute can take the following values:</p> <ul style="list-style-type: none"> ■ 0 - Logs all the fault and failover messages for the service group and its resources. ■ 1 - Disables the fault and failover messages of the service groups, but continues to log resource messages. ■ 2 - Disables the fault and failover messages of the service group resources, but continues to log service group messages. ■ 3 - Disables the fault and failover messages of both service groups and its resources.
DeferAutoStart (system use only)	<p>Indicates whether HAD defers the auto-start of a global group in the local cluster in case the global cluster is not fully connected.</p> <ul style="list-style-type: none"> ■ Type and dimension: boolean-scalar ■ Default: Not applicable
Enabled (user-defined)	<p>Indicates if a service group can be failed over or brought online.</p> <p>The attribute can have global or local scope. If you define local (system-specific) scope for this attribute, VCS prevents the service group from coming online on specified systems that have a value of 0 for the attribute. You can use this attribute to prevent failovers on a system when performing maintenance on the system.</p> <ul style="list-style-type: none"> ■ Type and dimension: boolean-scalar ■ Default: 1 (enabled)
Evacuate (user-defined)	<p>Indicates if VCS initiates an automatic failover when user issues <code>hastop -local -evacuate</code>.</p> <ul style="list-style-type: none"> ■ Type and dimension: boolean-scalar ■ Default: 1
Evacuating (system use only)	<p>Indicates the node ID from which the service group is being evacuated.</p> <ul style="list-style-type: none"> ■ Type and dimension: integer-scalar ■ Default: Not applicable

Table D-3 Service group attributes (*continued*)

Service Group Attributes	Definition
EvacList (system use only)	Contains list of pairs of low priority service groups and the systems on which they will be evacuated. For example: <pre>Grp1 EvacList grp2 Sys0 grp3 Sys0 grp4 Sys4</pre> Type and dimension: string-association Default: Not applicable.
EvacuatingForGroup (system use only)	Displays the name of the high priority service group for which evacuation is in progress. The service group name is visible only as long as the evacuation is in progress. Type and dimension: string-scalar Default: Not applicable.
Failover (system use only)	Indicates service group is in the process of failing over. <ul style="list-style-type: none"> ■ Type and dimension: boolean-scalar ■ Default: Not applicable

Table D-3 Service group attributes (*continued*)

Service Group Attributes	Definition
<p>FailOverPolicy (user-defined)</p>	<p>Defines the failover policy used by VCS to determine the system to which a group fails over. It is also used to determine the system on which a service group has been brought online through manual operation.</p> <p>The policy is defined only for clusters that contain multiple systems:</p> <p>Priority—The system defined as the lowest priority in the SystemList attribute is chosen.</p> <p>Load—The system with the highest value of AvailableCapacity is chosen.</p> <p>RoundRobin—Systems are chosen based on the active service groups they host. The system with the least number of active service groups is chosen first.</p> <p>BiggestAvailable—Systems are chosen based on the forecasted available capacity for all systems in the SystemList. The system with the highest available capacity forecasted is selected.</p> <p>Note: VCS selects the node in an alphabetical order when VCS detects two systems with same values set for the policy Priority, Load, RoundRobin, or BiggestAvailable.</p> <p>Prerequisites for setting FailOverPolicy to BiggestAvailable:</p> <ul style="list-style-type: none"> ■ The cluster attribute Statistics must be set to Enabled. ■ Veritas recommends that the cluster attribute HostMeters should contain at least one key. ■ The service group attribute Load must contain at least one key. ■ You cannot change the attribute from BiggestAvailable to some other value, when the service group attribute CapacityReserved is set to 1 because the VCS engine reserves system capacity when it determines BiggestAvailable for the service group. When the service group online transition completes and after the next forecast cycle, CapacityReserved is reset. ■ Type and dimension: string-scalar ■ Default: Priority

Table D-3 Service group attributes (*continued*)

Service Group Attributes	Definition
FaultPropagation (user-defined)	<p>Specifies if VCS should propagate the fault up to parent resources and take the entire service group offline when a resource faults.</p> <p>The value 1 indicates that when a resource faults, VCS fails over the service group, if the group's AutoFailOver attribute is set to 1. If The value 0 indicates that when a resource faults, VCS does not take other resources offline, regardless of the value of the Critical attribute. The service group does not fail over on resource fault.</p> <ul style="list-style-type: none"> ■ Type and dimension: boolean-scalar ■ Default: 1
FromQ (system use only)	<p>Indicates the system name from which the service group is failing over. This attribute is specified when service group failover is a direct consequence of the group event, such as a resource fault within the group or a group switch.</p> <ul style="list-style-type: none"> ■ Type and dimension: string-association ■ Default: Not applicable
Frozen (system use only)	<p>Disables all actions, including autostart, online and offline, and failover, except for monitor actions performed by agents. (This convention is observed by all agents supplied with VCS.)</p> <ul style="list-style-type: none"> ■ Type and dimension: boolean-scalar ■ Default: 0 (not frozen)
GroupOwner (user-defined)	<p>This attribute is used for VCS email notification and logging. VCS sends email notification to the person designated in this attribute when events occur that are related to the service group. Note that while VCS logs most events, not all events trigger notifications.</p> <p>Make sure to set the severity level at which you want notifications to be sent to GroupOwner or to at least one recipient defined in the SntpRecipients attribute of the NotifierMngr agent.</p> <ul style="list-style-type: none"> ■ Type and dimension: string-scalar ■ Default: ""

Table D-3 Service group attributes (*continued*)

Service Group Attributes	Definition
GroupRecipients (user-defined)	<p>This attribute is used for VCS email notification. VCS sends email notification to persons designated in this attribute when events related to the service group occur and when the event's severity level is equal to or greater than the level specified in the attribute.</p> <p>Make sure to set the severity level at which you want notifications to be sent to GroupRecipients or to at least one recipient defined in the SntpRecipients attribute of the NotifierMngr agent.</p> <ul style="list-style-type: none"> ■ Type and dimension: string-association ■ email id: The email address of the person registered as a recipient for notification. severity: The minimum level of severity at which notifications must be sent.
Guests (user-defined)	<p>List of operating system user accounts that have Guest privileges on the service group.</p> <p>This attribute applies to clusters running in secure mode.</p> <ul style="list-style-type: none"> ■ Type and dimension: string-keylist ■ Default: ""
IntentOnline (system use only)	<p>Indicates whether to keep service groups online or offline.</p> <p>VCS sets this attribute to 1 if an attempt has been made to bring the service group online.</p> <p>For failover groups, VCS sets this attribute to 0 when the group is taken offline.</p> <p>For parallel groups, it is set to 0 for the system when the group is taken offline or when the group faults and can fail over to another system.</p> <p>VCS sets this attribute to 2 for service groups if VCS attempts to autostart a service group; for example, attempting to bring a service group online on a system from AutoStartList.</p> <ul style="list-style-type: none"> ■ Type and dimension: integer-scalar ■ Default: Not applicable.

Table D-3 Service group attributes (*continued*)

Service Group Attributes	Definition
IntentionalOnlineList (system use only)	<p>Lists the nodes where a resource that can be intentionally brought online is found ONLINE at first probe. IntentionalOnlineList is used along with AutoStartList to determine the node on which the service group should go online when a cluster starts.</p> <ul style="list-style-type: none"> ■ Type and dimension: string-keylist ■ Default: Not applicable
LastSuccess (system use only)	<p>Indicates the time when service group was last brought online.</p> <ul style="list-style-type: none"> ■ Type and dimension: integer-scalar ■ Default: Not applicable
Load (user-defined)	<p>Indicates the multidimensional value expressing load exerted by a service group on the system.</p> <p>When the cluster attribute Statistics is enabled, the allowed key values are CPU, Mem, and Swap. The value for these keys in corresponding units as specified in MeterUnit (cluster attribute).</p> <p>When the cluster attribute Statistics is not enabled, the allowed key value is Units.</p> <ul style="list-style-type: none"> ■ Type and dimension: float-association ■ Default: Not applicable <p>The following additional considerations apply:</p> <ul style="list-style-type: none"> ■ You cannot change this attribute when the service group attribute CapacityReserved is set to 1 in the cluster and when the FailOverPolicy is set to BiggestAvailable. This is because the VCS engine reserves system capacity based on the service group attribute Load. <p>When the service group's online transition completes and after the next forecast cycle, CapacityReserved is reset.</p> <ul style="list-style-type: none"> ■ If the FailOverPolicy is set to BiggestAvailable for a service group, the attribute Load must be specified with at least one of the following keys: <ul style="list-style-type: none"> ■ CPU ■ Mem ■ Swap

Table D-3 Service group attributes (*continued*)

Service Group Attributes	Definition
ManageFaults (user-defined)	<p>Specifies if VCS manages resource failures within the service group by calling the Clean function for the resources. This attribute can take the following values.</p> <p>NONE—VCS does not call the Clean function for any resource in the group. You must manually handle resource faults.</p> <p>See “About controlling Clean behavior on resource faults” on page 429.</p> <ul style="list-style-type: none"> ■ Type and dimension: string-scalar ■ Default: ALL
ManualOps (user-defined)	<p>Indicates if manual operations are allowed on the service group.</p> <ul style="list-style-type: none"> ■ Type and dimension: boolean-scalar ■ Default = 1 (enabled)
MeterWeight (user-defined)	<p>Represents the weight given for the cluster attribute’s HostMeters key to determine a target system for a service group when more than one system meets the group attribute’s Load requirements.</p> <ul style="list-style-type: none"> ■ Type and dimension: integer-association ■ Default: Not applicable <p>Additional considerations for configuring this attribute in main.cf or changing it at run time:</p> <ul style="list-style-type: none"> ■ This is an optional service group attribute. If it is not defined for a group, the VCS considers the cluster attribute MeterWeight. ■ To override this attribute at an individual group level, define it at run time or in the main.cf file. Ensure that keys are subsets of the cluster attribute HostAvailableMeters. ■ You cannot change this attribute when the service group attribute CapacityReserved is set to 1 in the cluster. ■ The values for the keys represent weights of the corresponding parameters. It should be in range of 0 to 10.
MigrateQ (system use only)	<p>Indicates the system from which the service group is migrating. This attribute is specified when group failover is an indirect consequence (in situations such as a system shutdown or another group faults and is linked to this group).</p> <ul style="list-style-type: none"> ■ Type and dimension: string-association ■ Default: Not applicable

Table D-3 Service group attributes (*continued*)

Service Group Attributes	Definition
NumRetries (system use only)	Indicates the number of attempts made to bring a service group online. This attribute is used only if the attribute OnlineRetryLimit is set for the service group. <ul style="list-style-type: none"> ■ Type and dimension: integer-scalar ■ Default: Not applicable
OnlineAtUnfreeze (system use only)	When a node or a service group is frozen, the OnlineAtUnfreeze attribute specifies how an offline service group reacts after it or a node is unfrozen. <ul style="list-style-type: none"> ■ Type and dimension: integer-scalar ■ Default: Not applicable
OnlineClearParent	When this attribute is enabled for a service group and the service group comes online or is detected online, VCS clears the faults on all online type parent groups, such as online local, online global, and online remote. <ul style="list-style-type: none"> ■ Type and dimension: boolean-scalar ■ Default: 0 For example, assume that both the parent group and the child group faulted and both cannot failover. Later, when VCS tries again to bring the child group online and the group is brought online or detected online, the VCS engine clears the faults on the parent group, allowing VCS to restart the parent group too.
OnlineRetryInterval (user-defined)	Indicates the interval, in seconds, during which a service group that has successfully restarted on the same system and faults again should be failed over, even if the attribute OnlineRetryLimit is non-zero. This prevents a group from continuously faulting and restarting on the same system. <ul style="list-style-type: none"> ■ Type and dimension: integer-scalar ■ Default: 0
OnlineRetryLimit (user-defined)	If non-zero, specifies the number of times the VCS engine tries to restart a faulted service group on the same system on which the group faulted, before it gives up and tries to fail over the group to another system. <ul style="list-style-type: none"> ■ Type and dimension: integer-scalar ■ Default: 0

Table D-3 Service group attributes (*continued*)

Service Group Attributes	Definition
OperatorGroups (user-defined)	<p>List of operating system user groups that have Operator privileges on the service group. This attribute applies to clusters running in secure mode.</p> <ul style="list-style-type: none"> ■ Type and dimension: string-keylist ■ Default: ""
Operators (user-defined)	<p>List of VCS users with privileges to operate the group. A Group Operator can only perform online/offline, and temporary freeze/unfreeze operations pertaining to a specific group.</p> <p>See “About VCS user privileges and roles” on page 82.</p> <ul style="list-style-type: none"> ■ Type and dimension: string-keylist ■ Default: ""
Parallel (user-defined)	<p>Indicates if service group is failover (0), parallel (1), or hybrid(2).</p> <ul style="list-style-type: none"> ■ Type and dimension: integer-scalar ■ Default: 0
PathCount (system use only)	<p>Number of resources in path not yet taken offline. When this number drops to zero, the engine may take the entire service group offline if critical fault has occurred.</p> <ul style="list-style-type: none"> ■ Type and dimension: integer-scalar ■ Default: Not applicable
PCVAllowOnline (system use only)	<p>Indicates whether ProPCV-enabled resources in a service group can be brought online on a node outside VCS control.</p> <ul style="list-style-type: none"> ■ Type and dimension: boolean-scalar ■ Default: Not applicable <p>See “About preventing concurrency violation” on page 433.</p>

Table D-3 Service group attributes (*continued*)

Service Group Attributes	Definition
PolicyIntention (system use only)	<p>Functions as a lock on service groups listed in the <code>hagrp -online -propagate</code> command and <code>hagrp -offline -propagate</code> command:</p> <ul style="list-style-type: none"> ■ Type and dimension: integer-scalar <p>When PolicyIntention is set to a non-zero value for the service groups in dependency tree, this attribute protects the service groups from any other operation. PolicyIntention can take three values.</p> <ul style="list-style-type: none"> ■ The value 0 indicates that the service group is not part of the <code>hagrp -online -propagate</code> operation or the <code>hagrp -offline -propagate</code> operation. ■ The value 1 indicates that the service group is part of the <code>hagrp -online -propagate</code> operation. ■ The value 2 indicates that the service group is part of the <code>hagrp -offline -propagate</code> operation.
PreOnline (user-defined)	<p>Indicates that the VCS engine should not bring online a service group in response to a manual group online, group autostart, or group failover. The engine should instead run the PreOnline trigger.</p> <p>You can set a local (per-system) value or a global value for this attribute. A per-system value enables you to control the firing of PreOnline triggers on specific nodes in the cluster.</p> <ul style="list-style-type: none"> ■ Type and dimension: boolean-scalar ■ Default: 0 <p>You can change the attribute scope from local to global as follows:</p> <pre># hagrp -local <service_group_name> <attribute_name></pre> <p>You can change the attribute scope from global to local as follows:</p> <pre># hagrp -global <service_group_name> <attribute_name> <value> ... <key> ... {<key> <value>} ...</pre> <p>For more information about the <code>-local</code> option and the <code>-global</code> option, see the man pages associated with the <code>hagrp</code> command.</p>
PreOnlining (system use only)	<p>Indicates that VCS engine invoked the preonline script; however, the script has not yet returned with group online.</p> <ul style="list-style-type: none"> ■ Type and dimension: integer-scalar ■ Default: Not applicable

Table D-3 Service group attributes (*continued*)

Service Group Attributes	Definition
PreonlineTimeout (user-defined)	<p>Defines the maximum amount of time in seconds the preonline script takes to run the command <code>hagrp -online -nopre</code> for the group. Note that HAD uses this timeout during evacuation only. For example, when a user runs the command <code>hastop -local -evacuate</code> and the Preonline trigger is invoked on the system on which the service groups are being evacuated.</p> <ul style="list-style-type: none">■ Type and dimension: integer-scalar■ Default: 300
Prerequisites (user-defined)	<p>An unordered set of name=value pairs denoting specific resources required by a service group. If prerequisites are not met, the group cannot go online. The format for Prerequisites is:</p> <p>Prerequisites() = {Name=Value, name2=value2}.</p> <p>Names used in setting Prerequisites are arbitrary and not obtained from the system. Coordinate name=value pairs listed in Prerequisites with the same name=value pairs in Limits().</p> <p>See System limits and service group prerequisites on page 457.</p> <ul style="list-style-type: none">■ Type and dimension: integer-association

Table D-3 Service group attributes (*continued*)

Service Group Attributes	Definition
<p>PreSwitch (user-defined)</p>	<p>Indicates whether VCS engine should invoke PreSwitch actions in response to a manual service group switch operation.</p> <p>Note: The engine does not invoke the PreSwitch action during a group fault or when you use <code>-any</code> option to switch a group.</p> <p>This attribute must be defined in the global group definition on the remote cluster. This attribute takes the following values:</p> <p>0—VCS engine switches the service group normally.</p> <p>1—VCS engine switches the service group based on the output of PreSwitch action of the resources.</p> <p>If you set the value as 1, the VCS engine looks for any resource in the service group that supports PreSwitch action. If the action is not defined for any resource, the VCS engine switches a service group normally.</p> <p>If the action is defined for one or more resources, then the VCS engine invokes PreSwitch action for those resources. If all the actions succeed, the engine switches the service group. If any of the actions fail, the engine aborts the switch operation.</p> <p>The engine invokes the PreSwitch action in parallel and waits for all the actions to complete to decide whether to perform a switch operation. The VCS engine reports the action’s output to the engine log. The PreSwitch action does not change the configuration or the cluster state.</p> <p>See “Administering global service groups in a global cluster setup” on page 622.</p> <ul style="list-style-type: none"> ■ Type and dimension: boolean-scalar ■ Default: 0
<p>PreSwitching (system use only)</p>	<p>Indicates that the VCS engine invoked the agent’s PreSwitch action; however, the action is not yet complete.</p> <ul style="list-style-type: none"> ■ Type and dimension: integer-scalar ■ Default: Not applicable

Table D-3 Service group attributes (*continued*)

Service Group Attributes	Definition												
PrintTree (user-defined)	<p>Indicates whether or not the resource dependency tree is written to the configuration file. The value 1 indicates the tree is written.</p> <p>Note: For very large configurations, the time taken to print the tree and to dump the configuration is high.</p> <ul style="list-style-type: none"> ■ Type and dimension: boolean-scalar ■ Default: 1 												
Priority (user-defined)	<p>Enables users to designate and prioritize the service group. VCS does not interpret the value; rather, this attribute enables the user to configure the priority of a service group and the sequence of actions required in response to a particular event.</p> <p>If the cluster-level attribute value for PreferredFencingPolicy is set to Group, VCS uses this Priority attribute value to calculate the node weight to determine the surviving subcluster during I/O fencing race.</p> <p>VCS assigns the following node weight based on the priority of the service group:</p> <table border="0" data-bbox="579 933 892 1107"> <thead> <tr> <th>Priority</th> <th>Node weight</th> </tr> </thead> <tbody> <tr> <td>1</td> <td>625</td> </tr> <tr> <td>2</td> <td>125</td> </tr> <tr> <td>3</td> <td>25</td> </tr> <tr> <td>4</td> <td>5</td> </tr> <tr> <td>0 or >=5</td> <td>1</td> </tr> </tbody> </table> <p>A higher node weight is associated with higher values of Priority. The node weight is the sum of node weight values for service groups which are ONLINE/PARTIAL.</p> <p>See “About preferred fencing” on page 319.</p> <ul style="list-style-type: none"> ■ Type and dimension: integer-scalar ■ Default: 0 	Priority	Node weight	1	625	2	125	3	25	4	5	0 or >=5	1
Priority	Node weight												
1	625												
2	125												
3	25												
4	5												
0 or >=5	1												
Probed (system use only)	<p>Indicates whether all enabled resources in the group have been detected by their respective agents.</p> <ul style="list-style-type: none"> ■ Type and dimension: boolean-scalar ■ Default: Not applicable 												

Table D-3 Service group attributes (*continued*)

Service Group Attributes	Definition
ProbesPending (system use only)	<p>The number of resources that remain to be detected by the agent on each system.</p> <ul style="list-style-type: none"> ■ Type and dimension: integer-scalar ■ Default: Not applicable
ProPCV (user-defined)	<p>Indicates whether the service group is proactively prevented from concurrency violation for ProPCV-enabled resources.</p> <ul style="list-style-type: none"> ■ Type and dimension: boolean-scalar ■ Default: 0 <p>See “About preventing concurrency violation” on page 433.</p>
Responding (system use only)	<p>Indicates VCS engine is responding to a failover event and is in the process of bringing the service group online or failing over the node.</p> <ul style="list-style-type: none"> ■ Type and dimension: integer-scalar ■ Default: Not applicable
Restart (system use only)	<p>For internal use only.</p> <ul style="list-style-type: none"> ■ Type and dimension: integer-scalar ■ Default: Not applicable
SourceFile (user-defined)	<p>File from which the configuration is read. Do not configure this attribute in main.cf.</p> <p>Make sure the path exists on all nodes before running a command that configures this attribute.</p> <p>Make sure the path exists on all nodes before configuring this attribute.</p> <ul style="list-style-type: none"> ■ Type and dimension: string-scalar ■ Default: ./main.cf

Table D-3 Service group attributes (*continued*)

Service Group Attributes	Definition
<p>State (system use only)</p>	<p>Group state on each system:</p> <p>OFFLINE— All non-persistent resources are offline.</p> <p>ONLINE —All resources whose AutoStart attribute is equal to 1 are online.</p> <p>FAULTED—At least one critical resource in the group is faulted or is affected by a fault.</p> <p>PARTIAL—At least one, but not all, resources with Operations=OnOff is online, and not all AutoStart resources are online.</p> <p>STARTING—Group is attempting to go online.</p> <p>STOPPING— Group is attempting to go offline.</p> <p>MIGRATING— Group is attempting to migrate a resource from the source system to the target system. This state should be seen only as a combination of multiple states such as, ONLINE STOPPING MIGRATING, OFFLINE STARTING MIGRATING, and OFFLINE MIGRATING.</p> <p>A group state may be a combination of multiple states described above. For example, OFFLINE FAULTED, OFFLINE STARTING, PARTIAL FAULTED, PARTIAL STARTING, PARTIAL STOPPING, ONLINE STOPPING</p> <ul style="list-style-type: none"> ■ Type and dimension: integer-scalar ■ Default: Not applicable.

Table D-3 Service group attributes (*continued*)

Service Group Attributes	Definition
<p>SysDownPolicy (user-defined)</p>	<p>Determines whether a service group is autodisabled when the system is down and if the service group is taken offline when the system is rebooted or is shut down gracefully.</p> <p>If SysDownPolicy contains the key AutoDisableNoOffline, the following conditions apply:</p> <ul style="list-style-type: none"> ■ The service group is autodisabled when system is down, gracefully shut down, or is detected as down. ■ The service group is not taken offline when the system reboots or shuts down gracefully. <p>Valid values: Empty keylist or the key AutoDisableNoOffline</p> <p>Default: Empty keylist</p> <p>For example, if a service group with SysDownPolicy = AutoDisableNoOffline is online on system <i>sys1</i>, it has the following effect for various commands:</p> <ul style="list-style-type: none"> ■ The <code>hastop -local -evacuate</code> command for <i>sys1</i> is rejected ■ The <code>hastop -sysoffline</code> command is accepted but the service group with SysDownPolicy = AutoDisableNoOffline is not taken offline. ■ The <code>hastop -all</code> command is rejected.
<p>SystemList (user-defined)</p>	<p>List of systems on which the service group is configured to run and their priorities. Lower numbers indicate a preference for the system as a failover target.</p> <p>Note: You must define this attribute prior to setting the AutoStartList attribute.</p> <ul style="list-style-type: none"> ■ Type and dimension: integer-association ■ Default: "" (none)

Table D-3 Service group attributes (*continued*)

Service Group Attributes	Definition
SystemZones (user-defined)	<p>Indicates the virtual sublists within the SystemList attribute that grant priority in failing over. Values are string/integer pairs. The string key is the name of a system in the SystemList attribute, and the integer is the number of the zone. Systems with the same zone number are members of the same zone. If a service group faults on one system in a zone, it is granted priority to fail over to another system within the same zone, despite the policy granted by the FailOverPolicy attribute.</p> <ul style="list-style-type: none"> ■ Type and dimension: integer-association ■ Default: "" (none) <p>Note: You cannot modify this attribute when SiteAware is set as 1 and Sites are defined.</p>
Tag (user-defined)	<p>Identifies special-purpose service groups created for specific VCS products.</p> <ul style="list-style-type: none"> ■ Type and dimension: string-scalar ■ Default: Not applicable.
TargetCount (system use only)	<p>Indicates the number of target systems on which the service group should be brought online.</p> <ul style="list-style-type: none"> ■ Type and dimension: integer-scalar ■ Default: Not applicable.
TFrozen (user-defined)	<p>Indicates if service groups can be brought online or taken offline on nodes in the cluster. Service groups cannot be brought online or taken offline if the value of the attribute is 1.</p> <ul style="list-style-type: none"> ■ Type and dimension: boolean-scalar ■ Default: 0 (not frozen)
ToQ (system use only)	<p>Indicates the node name to which the service is failing over. This attribute is specified when service group failover is a direct consequence of the group event, such as a resource fault within the group or a group switch.</p> <ul style="list-style-type: none"> ■ Type and dimension: string-association ■ Default: Not applicable

Table D-3 Service group attributes (*continued*)

Service Group Attributes	Definition
TriggerEvent (user-defined)	<p>For internal use only.</p> <ul style="list-style-type: none"> ■ Type and dimension: boolean-scalar ■ Default: Not applicable
TriggerPath (user-defined)	<p>Enables you to customize the trigger path.</p> <p>If a trigger is enabled but the trigger path is "" (default), VCS invokes the trigger from the \$VCS_HOME/bin/<i>triggers</i> directory. If you specify an alternate directory, VCS invokes the trigger from that path. The value is case-sensitive. VCS does not trim the leading spaces or trailing spaces in the Trigger Path value. If the path contains leading spaces or trailing spaces, the trigger might fail to get executed.</p> <p>The path that you specify must be in the following format:</p> <p><code>\$VCS_HOME/TriggerPath/Trigger</code></p> <p>For example, if TriggerPath is set to mytriggers/sg1, VCS looks for the preonline trigger scripts in the \$VCS_HOME/mytriggers/sg1/preonline/ directory.</p> <ul style="list-style-type: none"> ■ Type and dimension: string-scalar ■ Default: ""
TriggerResFault (user-defined)	<p>Defines whether VCS invokes the resfault trigger when a resource faults. The value 0 indicates that VCS does not invoke the trigger.</p> <ul style="list-style-type: none"> ■ Type and dimension: boolean-scalar ■ Default: 1
TriggerResRestart (user-defined)	<p>Determines whether or not to invoke the resrestart trigger if resource restarts.</p> <p>See “About the resrestart event trigger” on page 524.</p> <p>To invoke the resrestart trigger for a specific resource, enable this attribute at the resource level.</p> <p>See “Resource attributes” on page 764.</p> <ul style="list-style-type: none"> ■ Type and dimension: boolean-scalar ■ Default: 0 (disabled)

Table D-3 Service group attributes (*continued*)

Service Group Attributes	Definition
TriggerResStateChange (user-defined)	<p>Determines whether or not to invoke the resstatechange trigger if resource state changes.</p> <p>See “About the resstatechange event trigger” on page 525.</p> <p>To invoke the resstatechange trigger for a specific resource, enable this attribute at the resource level.</p> <p>See “Resource attributes” on page 764.</p> <ul style="list-style-type: none"> ■ Type and dimension: boolean-scalar ■ Default: 0 (disabled)
TriggersEnabled (user-defined)	<p>Determines if a specific trigger is enabled or not.</p> <p>Triggers are disabled by default. You can enable specific triggers on all nodes or on selected nodes. Valid values are VIOLATION, NOFAILOVER, PREONLINE, POSTONLINE, POSTOFFLINE, RESFAULT, RESSTATECHANGE, and RESRESTART.</p> <p>To enable triggers on a node, add trigger keys in the following format:</p> <p>TriggersEnabled@node1 = {POSTOFFLINE, POSTONLINE}</p> <p>The postoffline trigger and postonline trigger are enabled on node1.</p> <p>To enable triggers on all nodes in the cluster, add trigger keys in the following format:</p> <p>TriggersEnabled = {POSTOFFLINE, POSTONLINE}</p> <p>The postoffline trigger and postonline trigger are enabled on all nodes.</p> <ul style="list-style-type: none"> ■ Type and dimension: string-keylist ■ Default: {} <p>You can change the attribute scope from local to global as follows:</p> <pre># hagrps -local <service_group_name> <attribute_name></pre> <p>You can change the attribute scope from global to local as follows:</p> <pre># hagrps -global <service_group_name> <attribute_name> <value> ... <key> ... {<key> <value>} ...</pre> <p>For more information about the <code>-local</code> option and the <code>-global</code> option, see the man pages associated with the <code>hagrps</code> command.</p>

Table D-3 Service group attributes (*continued*)

Service Group Attributes	Definition
TypeDependencies (user-defined)	<p>Creates a dependency (via an ordered list) between resource types specified in the service group list, and all instances of the respective resource type.</p> <ul style="list-style-type: none"> ■ Type and dimension: string-keylist ■ Default: ""
UnSteadyCount (system use only)	<p>Represents the total number of resources with pending online or offline operations. This is a localized attribute.</p> <ul style="list-style-type: none"> ■ Type and dimension: integer ■ Default: 0 <p>To list this attribute, use the <code>-all</code> option with the <code>hagrp -display</code> command.</p> <p>The <code>hagrp -flush</code> command resets this attribute.</p>
UserAssoc (user-defined)	<p>This is a free form string-association attribute to hold any key-value pair. "Name" and "Timeout" keys are reserved by VCS health view. You must not delete these keys or update the values corresponding to these keys, but you can add other keys and use it for any other purpose.</p> <ul style="list-style-type: none"> ■ Type and dimension: string-association ■ Default: {} <p>You can change the attribute scope from local to global as follows:</p> <pre># hagrp -local <service_group_name> <attribute_name></pre> <p>You can change the attribute scope from global to local as follows:</p> <pre># hagrp -global <service_group_name> <attribute_name> <value> ... <key> ... {<key> <value>} ...</pre> <p>For more information about the <code>-local</code> option and <code>-global</code> option, see the man pages associated with the <code>hagrp</code> command.</p>
UserIntGlobal (user-defined)	<p>Use this attribute for any purpose. It is not used by VCS.</p> <ul style="list-style-type: none"> ■ Type and dimension: integer-scalar ■ Default: 0

Table D-3 Service group attributes (*continued*)

Service Group Attributes	Definition
UserStrGlobal (user-defined)	VCS uses this attribute in the ClusterService group. Do not modify this attribute in the ClusterService group. Use the attribute for any purpose in other service groups. <ul style="list-style-type: none">■ Type and dimension: string-scalar■ Default: 0
UserIntLocal (user-defined)	Use this attribute for any purpose. It is not used by VCS. <ul style="list-style-type: none">■ Type and dimension: integer-scalar■ Default: 0
UserStrLocal (user-defined)	Use this attribute for any purpose. It is not used by VCS. <ul style="list-style-type: none">■ Type and dimension: string-scalar■ Default: ""

System attributes

[Table D-4](#) lists the system attributes.

Table D-4 System attributes

System Attributes	Definition
AgentsStopped (system use only)	This attribute is set to 1 on a system when all agents running on the system are stopped. <ul style="list-style-type: none">■ Type and dimension: integer-scalar■ Default: Not applicable

Table D-4 System attributes (*continued*)

System Attributes	Definition
AvailableCapacity (system use only)	<p data-bbox="655 326 1089 352">Indicates the available capacity of the system.</p> <p data-bbox="655 369 1210 453">The function of this attribute depends on the value of the cluster-level attribute Statistics. If the value of the Statistics is:</p> <ul data-bbox="655 470 1210 644" style="list-style-type: none"><li data-bbox="655 470 1210 522">■ Enabled—Any change made to AvailableCapacity does not affect VCS behavior.<li data-bbox="655 531 1210 644">■ MeteringOnly or Disabled—This attribute is populated based on Capacity and DynamicLoad (system attributes) and Load (service group attribute) specified using the <code>hasys -load</code> command. The key for this value is Units. <p data-bbox="655 661 1150 687">You cannot configure this attribute in the main.cf file.</p> <ul data-bbox="655 704 1042 765" style="list-style-type: none"><li data-bbox="655 704 1042 730">■ Type and dimension: float-association<li data-bbox="655 739 901 765">■ Default: Not applicable

Table D-4 System attributes (*continued*)

System Attributes	Definition
Capacity (user-defined)	<p>Represents total capacity of a system. The possible values are:</p> <ul style="list-style-type: none"> ■ Enabled—The attribute Capacity is auto-populated by meters representing system capacity in absolute units. It has all the keys specified in HostMeters, such as CPU, Mem, and Swap. The values for keys are set in corresponding units as specified in the Cluster attribute MeterUnit. You cannot configure this attribute in the main.cf file if the cluster-level attribute Statistics is set to Enabled. If the cluster-level attribute Statistics is enabled, any change made to Capacity does not affect VCS behavior. ■ MeteringOnly or Disabled—Allows you to define a value for Capacity if the value of the cluster-level attribute Statistics is set to MeteringOnly or Disabled. This value is relative to other systems in the cluster and does not reflect any real value associated with a particular system. The key for this value is Units. The default value for this attribute is 100 Units. For example, the administrator may assign a value of 200 to a 16-processor system and 100 to an 8-processor system. You can configure this attribute in the main.cf file and also modify the value at run time if Statistics is set to MeteringOnly or Disabled. <ul style="list-style-type: none"> ■ Type and dimension: float-association ■ Default: Depends on the value set for Statistics.
ConfigBlockCount (system use only)	<p>Number of 512-byte blocks in configuration when the system joined the cluster.</p> <ul style="list-style-type: none"> ■ Type and dimension: integer-scalar ■ Default: Not applicable
ConfigChecksum (system use only)	<p>Sixteen-bit checksum of configuration identifying when the system joined the cluster.</p> <ul style="list-style-type: none"> ■ Type and dimension: integer-scalar ■ Default: Not applicable

Table D-4 System attributes (*continued*)

System Attributes	Definition
ConfigDiskState (system use only)	<p>State of configuration on the disk when the system joined the cluster.</p> <ul style="list-style-type: none"> ■ Type and dimension: integer-scalar ■ Default: Not applicable
ConfigFile (system use only)	<p>Directory containing the configuration files.</p> <ul style="list-style-type: none"> ■ Type and dimension: string-scalar ■ Default: <code>"/etc/VRTSvcs/conf/config"</code>
ConfigInfoCnt (system use only)	<p>The count of outstanding CONFIG_INFO messages the local node expects from a new membership message. This attribute is non-zero for the brief period during which new membership is processed. When the value returns to 0, the state of all nodes in the cluster is determined.</p> <ul style="list-style-type: none"> ■ Type and dimension: integer-scalar ■ Default: Not applicable
ConfigModDate (system use only)	<p>Last modification date of configuration when the system joined the cluster.</p> <ul style="list-style-type: none"> ■ Type and dimension: integer-scalar ■ Default: Not applicable
CPUBinding	<p>Binds HAD to a particular logical processor ID depending on the value of BindTo and CPUNumber. Interrupts are disabled on the logical processor that HAD binds to.</p> <ul style="list-style-type: none"> ■ Type and dimension: string-association ■ Default: BindTo = NONE, CPUNumber = 0 <p>CPUNumber specifies the logical processor ID to which HAD binds. CPUNumber is used only when BindTo is specified as CPUNUM.</p> <p>BindTo can take one of the following values:</p> <ul style="list-style-type: none"> ■ NONE: HAD is not bound to any logical processor ID. ■ ANY: HAD is pinned to a logical processor ID till it is in RUNNING state or BindTo is changed. ■ CPUNUM: HAD is pinned to the logical processor ID specified by CPUNumber.

Table D-4 System attributes (*continued*)

System Attributes	Definition
CPUThresholdLevel (user-defined)	Determines the threshold values for CPU utilization based on which various levels of logs are generated. The notification levels are Critical, Warning, Note, and Info, and the logs are stored in the file engine_A.log. If the Warning level is crossed, a notification is generated. The values are configurable at a system level in the cluster. <ul style="list-style-type: none"> ■ For example, the administrator may set the value of CPUThresholdLevel as follows: ■ CPUThresholdLevel={Critical=95, Warning=80, Note=75, Info=60} ■ Type and dimension: integer-association ■ Default: Critical=90, Warning=80, Note=70, Info=60
CPUUsage (system use only)	This attribute is deprecated. VCS monitors system resources on startup.
CPUUsageMonitoring	This attribute is deprecated. VCS monitors system resources on startup.
CurrentLimits (system use only)	System-maintained calculation of current value of Limits. CurrentLimits = Limits - (additive value of all service group Prerequisites). <ul style="list-style-type: none"> ■ Type and dimension: integer-association ■ Default: Not applicable
DiskHbStatus (system use only)	Deprecated attribute. Indicates status of communication disks on any system. <ul style="list-style-type: none"> ■ Type and dimension: string-association ■ Default: Not applicable
DynamicLoad (user-defined)	System-maintained value of current dynamic load. The value is set external to VCS with the <code>hasys -load</code> command. When you specify the dynamic system load, VCS does not use the static group load. <ul style="list-style-type: none"> ■ Type and dimension: float-association ■ Default: "" (none)

Table D-4 System attributes (*continued*)

System Attributes	Definition
EngineRestarted (system use only)	<p>Indicates whether the VCS engine (HAD) was restarted by the hashadow process on a node in the cluster. The value 1 indicates that the engine was restarted; 0 indicates it was not restarted.</p> <ul style="list-style-type: none"> ■ Type and dimension: boolean-scalar ■ Default: 0
EngineVersion (system use only)	<p>Specifies the major, minor, maintenance-patch, and point-patch version of VCS.</p> <p>The value of EngineVersion attribute is in hexa-decimal format. To retrieve version information:</p> <pre>Major Version: EngineVersion >> 24 & 0xff Minor Version: EngineVersion >> 16 & 0xff Maint Patch: EngineVersion >> 8 & 0xff Point Patch: EngineVersion & 0xff</pre> <ul style="list-style-type: none"> ■ Type and dimension: integer-scalar ■ Default: Not applicable
FencingWeight (user-defined)	<p>Indicates the system priority for preferred fencing. This value is relative to other systems in the cluster and does not reflect any real value associated with a particular system.</p> <p>If the cluster-level attribute value for PreferredFencingPolicy is set to System, VCS uses this FencingWeight attribute to determine the node weight to ascertain the surviving subcluster during I/O fencing race.</p> <p>See “About preferred fencing” on page 319.</p> <ul style="list-style-type: none"> ■ Type and dimension: integer-scalar ■ Default: 0
Frozen (system use only)	<p>Indicates if service groups can be brought online on the system. Groups cannot be brought online if the attribute value is 1.</p> <ul style="list-style-type: none"> ■ Type and dimension: boolean-scalar ■ Default: 0

Table D-4 System attributes (*continued*)

System Attributes	Definition
GUIIPAddr (user-defined)	<p>Determines the local IP address that VCS uses to accept connections. Incoming connections over other IP addresses are dropped. If GUIIPAddr is not set, the default behavior is to accept external connections over all configured local IP addresses.</p> <p>See “User privileges for CLI commands” on page 84.</p> <ul style="list-style-type: none"> ■ Type and dimension: string-scalar ■ Default: ""
HostAvailableForecast (system use only)	<p>Indicates the forecasted available capacities of the systems in a cluster based on the past metered AvailableCapacity.</p> <p>The HostMonitor agent auto-populates values for this attribute, if the cluster attribute Statistics is set to Enabled. It has all the keys specified in HostMeters, such as CPU, Mem, and Swap. The values for keys are set in corresponding units as specified in the Cluster attribute MeterUnit.</p> <p>You cannot configure this attribute in main.cf.</p> <ul style="list-style-type: none"> ■ Type and dimension: float-association ■ Default: Not applicable
HostMonitor (system use only)	<p>List of host resources that the HostMonitor agent monitors. The values of keys such as Mem and Swap are measured in MB or GB, and CPU is measured in MHz or GHz.</p> <ul style="list-style-type: none"> ■ Type and dimension: string-keylist ■ Default: { CPU, Mem, Swap }
HostUtilization (system use only)	<p>Indicates the percentage usage of the resources on the host as computed by the HostMonitor agent. This attribute populates all parameters specified in the cluster attribute HostMeters if Statistics is set to MeterHostOnly or Enabled.</p> <ul style="list-style-type: none"> ■ Type and dimension: integer-association ■ Default: Not applicable

Table D-4 System attributes (*continued*)

System Attributes	Definition
LicenseType (system use only)	Indicates the license type of the base VCS key used by the system. Possible values are: 0—DEMO 1—PERMANENT 2—PERMANENT_NODE_LOCK 3—DEMO_NODE_LOCK 4—NFR 5—DEMO_EXTENSION 6—NFR_NODE_LOCK 7—DEMO_EXTENSION_NODE_LOCK <ul style="list-style-type: none"> ■ Type and dimension: integer-scalar ■ Default: Not applicable
Limits (user-defined)	An unordered set of name=value pairs denoting specific resources available on a system. Names are arbitrary and are set by the administrator for any value. Names are not obtained from the system. The format for Limits is: Limits = { Name=Value, Name2=Value2}. <ul style="list-style-type: none"> ■ Type and dimension: integer-association ■ Default: ""
LinkHbStatus (system use only)	Indicates status of private network links on any system. Possible values include the following: <code>LinkHbStatus = { nic1 = UP, nic2 = DOWN }</code> Where the value UP for <i>nic1</i> means there is at least one peer in the cluster that is visible on <i>nic1</i> . Where the value DOWN for <i>nic2</i> means no peer in the cluster is visible on <i>nic2</i> . <ul style="list-style-type: none"> ■ Type and dimension: string-association ■ Default: Not applicable

Table D-4 System attributes (*continued*)

System Attributes	Definition
LLTNodeID (system use only)	Displays the node ID defined in the file. /etc/lfttab. <ul style="list-style-type: none"> ■ Type and dimension: integer-scalar ■ Default: Not applicable
LoadTimeCounter (system use only)	System-maintained internal counter of how many seconds the system load has been above LoadWarningLevel. This value resets to zero anytime system load drops below the value in LoadWarningLevel. If the cluster-level attribute Statistics is enabled, any change made to LoadTimeCounter does not affect VCS behavior. <ul style="list-style-type: none"> ■ Type and dimension: integer-scalar ■ Default: Not applicable
LoadTimeThreshold (user-defined)	How long the system load must remain at or above LoadWarningLevel before the LoadWarning trigger is fired. If set to 0 overload calculations are disabled. If the cluster-level attribute Statistics is enabled, any change made to LoadTimeThreshold does not affect VCS behavior. <ul style="list-style-type: none"> ■ Type and dimension: integer-scalar ■ Default: 600
LoadWarningLevel (user-defined)	A percentage of total capacity where load has reached a critical limit. If set to 0 overload calculations are disabled. For example, setting LoadWarningLevel = 80 sets the warning level to 80 percent. The value of this attribute can be set from 1 to 100. If set to 1, system load must equal 1 percent of system capacity to begin incrementing the LoadTimeCounter. If set to 100, system load must equal system capacity to increment the LoadTimeCounter. If the cluster-level attribute Statistics is enabled, any change made to LoadWarningLevel does not affect VCS behavior. <ul style="list-style-type: none"> ■ Type and dimension: integer-scalar ■ Default: 80

Table D-4 System attributes (*continued*)

System Attributes	Definition
MemThresholdLevel (user-defined)	<p>Determines the threshold values for memory utilization based on which various levels of logs are generated. The notification levels are Critical, Warning, Note, and Info, and the logs are stored in the file engine_A.log. If the Warning level is crossed, a notification is generated. The values are configurable at a system level in the cluster.</p> <p>For example, the administrator may set the value of MemThresholdLevel as follows:</p> <ul style="list-style-type: none">■ MemThresholdLevel={Critical=95, Warning=80, Note=75, Info=60}■ Type and dimension: integer-association■ Default: Critical=90, Warning=80, Note=70, Info=60

Table D-4 System attributes (*continued*)

System Attributes	Definition
MeterRecord (system use only)	<p>Acts as an internal system attribute with predefined keys. This attribute is updated only when the Cluster attribute AdpativePolicy is set to Enabled.</p> <ul style="list-style-type: none"> ■ Type and dimension: integer-association ■ Default: Not applicable <p>Possible keys are:</p> <ul style="list-style-type: none"> ■ AvailableGC: Stores the value of the cluster attribute GlobalCounter when the HostMonitor agent updates the system attribute AvailableCapacity. If the value of AvailableGC for a system in running state is older than the last 24 values of the cluster attribute GlobalCounter it indicates: <ul style="list-style-type: none"> ■ Values are not updated at the required frequency by the HostMonitor agent. ■ Values of system attributes AvailableCapacity and HostUtilization are stale. ■ ForecastGC: Stores cluster attribute GlobalCounter value when system HostAvailableForecast attribute is updated. If the value of ForecastGC for a system in running state is older than the last 72 values of the cluster attribute GlobalCounter it indicates : <ul style="list-style-type: none"> ■ HostMonitor agent is not forecasting the available capacity at the required frequency. ■ The values of the system attribute HostAvailableForecast are stale. ■ If any of the running systems in SystemList have stale value in HostAvailableForecast when FailOverPolicy is set to BiggestAvailable, then VCS does not apply BiggestAvailable policy. Instead, it considers Priority as the FailOverPolicy.
NoAutoDisable (system use only)	<p>When set to 0, this attribute autodisables service groups when the VCS engine is taken down. Groups remain autodisabled until the engine is brought up (regular membership).</p> <p>This attribute's value is updated whenever a node joins (gets into RUNNING state) or leaves the cluster. This attribute cannot be set manually.</p> <ul style="list-style-type: none"> ■ Type and dimension: boolean-scalar ■ Default: 0

Table D-4 System attributes (*continued*)

System Attributes	Definition
NodeId (system use only)	System (node) identification specified in: /etc/lfttab. <ul style="list-style-type: none"> ■ Type and dimension: integer-scalar ■ Default: Not applicable
OnGrpCnt (system use only)	Number of groups that are online, or about to go online, on a system. <ul style="list-style-type: none"> ■ Type and dimension: integer-scalar ■ Default: Not applicable
PhysicalServer (system use only)	Indicates the name of the physical system on which the VM is running when VCS is deployed on a VM. <ul style="list-style-type: none"> ■ Type and dimension: string-scalar ■ Default: Not applicable
ReservedCapacity (system use only)	Indicates the reserved capacity on the systems for service groups which are coming online and with FailOverPolicy is set to BiggestAvailable. It has all of the keys specified in HostMeters, such as CPU, Mem, and Swap. The values for keys are set in corresponding units as specified in the Cluster attribute MeterUnit. <ul style="list-style-type: none"> ■ Type and dimension: float-association ■ Default: Not applicable When the service group completes online transition and after the next forecast cycle, ReservedCapacity is updated. You cannot configure this attribute in main.cf.

Table D-4 System attributes (*continued*)

System Attributes	Definition
ShutdownTimeout (user-defined)	<p>Determines whether to treat system reboot as a fault for service groups running on the system.</p> <p>On many systems, when a reboot occurs the processes are stopped first, then the system goes down. When the VCS engine is stopped, service groups that include the failed system in their SystemList attributes are autodisabled. However, if the system goes down within the number of seconds designated in ShutdownTimeout, service groups previously online on the failed system are treated as faulted and failed over. Veritas recommends that you set this attribute depending on the average time it takes to shut down the system.</p> <p>If you do not want to treat the system reboot as a fault, set the value for this attribute to 0.</p> <ul style="list-style-type: none"> ■ Type and dimension: integer-scalar ■ Default: 600 seconds
SourceFile (user-defined)	<p>File from which the configuration is read. Do not configure this attribute in main.cf.</p> <p>Make sure the path exists on all nodes before running a command that configures this attribute.</p> <ul style="list-style-type: none"> ■ Type and dimension: string-scalar ■ Default: ./main.cf
SwapThresholdLevel (user-defined)	<p>Determines the threshold values for swap space utilization based on which various levels of logs are generated. The notification levels are Critical, Warning, Note, and Info, and the logs are stored in the file engine_A.log. If the Warning level is crossed, a notification is generated. The values are configurable at a system level in the cluster.</p> <ul style="list-style-type: none"> ■ For example, the administrator may set the value of SwapThresholdLevel as follows: ■ SwapThresholdLevel={Critical=95, Warning=80, Note=75, Info=60} ■ Type and dimension: integer-association ■ Default: Critical=90, Warning=80, Note=70, Info=60

Table D-4 System attributes (*continued*)

System Attributes	Definition
SysInfo (system use only)	Provides platform-specific information, including the name, version, and release of the operating system, the name of the system on which it is running, and the hardware type. <ul style="list-style-type: none"> ■ Type and dimension: string-scalar ■ Default: Not applicable
SysName (system use only)	Indicates the system name. <ul style="list-style-type: none"> ■ Type and dimension: string-scalar ■ Default: Not applicable
SysState (system use only)	Indicates system states, such as RUNNING, FAULTED, EXITED, etc. <ul style="list-style-type: none"> ■ Type and dimension: integer-scalar ■ Default: Not applicable
SystemLocation (user-defined)	Indicates the location of the system. <ul style="list-style-type: none"> ■ Type and dimension: string-scalar ■ Default: ""
SystemOwner (user-defined)	Use this attribute for VCS email notification and logging. VCS sends email notification to the person designated in this attribute when an event occurs related to the system. Note that while VCS logs most events, not all events trigger notifications. Make sure to set the severity level at which you want notifications to SystemOwner or to at least one recipient defined in the Smtprcipients attribute of the NotifierMngr agent. <ul style="list-style-type: none"> ■ Type and dimension: string-scalar ■ Default: "" ■ Example: "unknown"

Table D-4 System attributes (*continued*)

System Attributes	Definition
SystemRecipients (user-defined)	<p>This attribute is used for VCS email notification. VCS sends email notification to persons designated in this attribute when events related to the system occur and when the event's severity level is equal to or greater than the level specified in the attribute.</p> <p>Make sure to set the severity level at which you want notifications to be sent to SystemRecipients or to at least one recipient defined in the SntpRecipients attribute of the NotifierMngr agent.</p> <ul style="list-style-type: none"> ■ Type and dimension: string-association ■ email id: The e-mail address of the person registered as a recipient for notification. severity: The minimum level of severity at which notifications must be sent.
TFrozen (user-defined)	<p>Indicates whether a service group can be brought online on a node. Service group cannot be brought online if the value of this attribute is 1.</p> <ul style="list-style-type: none"> ■ Type and dimension: boolean-scalar ■ Default: 0
TRSE (system use only)	<p>Indicates in seconds the time to Regular State Exit. Time is calculated as the duration between the events of VCS losing port h membership and of VCS losing port a membership of GAB.</p> <ul style="list-style-type: none"> ■ Type and dimension: integer-scalar ■ Default: Not applicable
UpDownState (system use only)	<p>This attribute has four values:</p> <p>Down (0): System is powered off, or GAB and LLT are not running on the system.</p> <p>Up but not in cluster membership (1): GAB and LLT are running but the VCS engine is not.</p> <p>Up and in jeopardy (2): The system is up and part of cluster membership, but only one network link (LLT) remains.</p> <p>Up (3): The system is up and part of cluster membership, and has at least two links to the cluster.</p> <ul style="list-style-type: none"> ■ Type and dimension: integer-scalar ■ Default: Not applicable

Table D-4 System attributes (*continued*)

System Attributes	Definition
UserInt (user-defined)	Stores integer values you want to use. VCS does not interpret the value of this attribute. <ul style="list-style-type: none"> ■ Type and dimension: integer-scalar ■ Default: 0
VCSFeatures (system use only)	Indicates which VCS features are enabled. Possible values are: <p>0—No features enabled (VCS Simulator)</p> <p>1—L3+ is enabled</p> <p>2—Global Cluster Option is enabled</p> <p>Even though VCSFeatures attribute is an integer attribute, when you query the value with the <code>hasys -value</code> command or the <code>hasys -display</code> command, it displays as the string L10N for value 1 and DR for value 2.</p> <ul style="list-style-type: none"> ■ Type and dimension: integer-scalar ■ Default: Not applicable

Cluster attributes

[Table D-5](#) lists the cluster attributes.

Table D-5 Cluster attributes

Cluster Attributes	Definition
AdministratorGroups (user-defined)	List of operating system user account groups that have administrative privileges on the cluster. This attribute applies to clusters running in secure mode. <ul style="list-style-type: none"> ■ Type and dimension: string-keylist ■ Default: ""
Administrators (user-defined)	Contains list of users with Administrator privileges. <ul style="list-style-type: none"> ■ Type and dimension: string-keylist ■ Default: ""
AutoClearQ (System use only)	Lists the service groups scheduled to be auto-cleared. It also indicates the time at which the auto-clear for the group will be performed.

Table D-5 Cluster attributes (*continued*)

Cluster Attributes	Definition
AutoStartTimeout (user-defined)	<p>If the local cluster cannot communicate with one or more remote clusters, this attribute specifies the number of seconds the VCS engine waits before initiating the AutoStart process for an AutoStart global service group.</p> <ul style="list-style-type: none">■ Type and dimension: integer-scalar■ Default: 150 seconds
AutoAddSystemtoCSG (user-defined)	<p>Indicates whether the newly joined or added systems in cluster become part of the SystemList of the ClusterService service group if the service group is configured. The value 1 (default) indicates that the new systems are added to SystemList of ClusterService. The value 0 indicates that the new systems are not added to SystemList of ClusterService.</p> <ul style="list-style-type: none">■ Type and dimension: integer-scalar■ Default: 1
BackupInterval (user-defined)	<p>Time period in minutes after which VCS backs up the configuration files if the configuration is in read-write mode.</p> <p>The value 0 indicates VCS does not back up configuration files. Set this attribute to at least 3.</p> <p>See “Scheduling automatic backups for VCS configuration files” on page 196.</p> <ul style="list-style-type: none">■ Type and dimension: integer-scalar■ Default: 0

Table D-5 Cluster attributes (*continued*)

Cluster Attributes	Definition
CID (system defined)	<p>The CID provides universally unique identification for a cluster.</p> <p>VCS populates this attribute once the engine passes an hacf-generated snapshot to it. This happens when VCS is about to go to a RUNNING state from the LOCAL_BUILD state.</p> <p>Once VCS receives the snapshot from the engine, it reads the file <code>/etc/vx/.uuids/clusuuid</code> file. VCS uses the file's contents as the value for the CID attribute. The <code>clusuuid</code> file's first line must not be empty. If the file does not exist or is empty VCS then exits gracefully and throws an error.</p> <p>A node that joins a cluster in the RUNNING state receives the CID attribute as part of the REMOTE_BUILD snapshot. Once the node has joined completely, it receives the snapshot. The node reads the file <code>/etc/vx/.uuids/clusuuid</code> to compare the value that it received from the snapshot with value that is present in the file. If the value does not match or if the file does not exist, the joining node exits gracefully and does not join the cluster.</p> <p>To populate the <code>/etc/vx/.uuids/clusuuid</code> file, run the <code>/opt/VRTSvcs/bin/uuidconfig.pl</code> utility.</p> <p>See "Configuring and unconfiguring the cluster UUID value" on page 242.</p> <p>You cannot change the value of this attribute with the <code>haclus -modify</code> command.</p> <ul style="list-style-type: none"> ■ Type and dimension: string-scalar ■ Default: ""
ClusState (system use only)	<p>Indicates the current state of the cluster.</p> <ul style="list-style-type: none"> ■ Type and dimension: integer-scalar ■ Default: Not applicable.
ClusterAddress (user-defined)	<p>Specifies the cluster's virtual IP address (used by a remote cluster when connecting to the local cluster).</p> <ul style="list-style-type: none"> ■ Type and dimension: string-scalar ■ Default: ""
ClusterLocation (user-defined)	<p>Specifies the location of the cluster.</p> <ul style="list-style-type: none"> ■ Type and dimension: string-scalar ■ Default: ""
ClusterName (user-defined)	<p>The name of cluster.</p> <ul style="list-style-type: none"> ■ Type and dimension: string-scalar ■ Default: ""

Table D-5 Cluster attributes (*continued*)

Cluster Attributes	Definition
ClusterOwner (user-defined)	<p>This attribute used for VCS notification. VCS sends notifications to persons designated in this attribute when an event occurs related to the cluster. Note that while VCS logs most events, not all events trigger notifications.</p> <p>Make sure to set the severity level at which you want notifications to be sent to ClusterOwner or to at least one recipient defined in the Smtprcipients attribute of the NotifierMngr agent.</p> <p>See “About VCS event notification” on page 499.</p> <ul style="list-style-type: none"> ■ Type and dimension: string-scalar ■ Default: "" ■ Example: "jdoe@example.com"
ClusterRecipients (user-defined)	<p>This attribute is used for VCS email notification. VCS sends email notification to persons designated in this attribute when events related to the cluster occur and when the event's severity level is equal to or greater than the level specified in the attribute.</p> <p>Make sure to set the severity level at which you want notifications to be sent to ClusterRecipients or to at least one recipient defined in the Smtprcipients attribute of the NotifierMngr agent.</p> <ul style="list-style-type: none"> ■ Type and dimension: string-association ■ email id: The e-mail address of the person registered as a recipient for notification. ■ severity: The minimum level of severity at which notifications must be sent.
ClusterTime (system use only)	<p>The number of seconds since January 1, 1970. This is defined by the lowest node in running state.</p> <ul style="list-style-type: none"> ■ Type and dimension: string-scalar ■ Default: Not applicable
ClusterUUID (system use only)	<p>Unique ID assigned to the cluster by Availability Manager.</p> <ul style="list-style-type: none"> ■ Type and dimension: string-scalar ■ Default: Not applicable
CompareRSM (system use only)	<p>Indicates if VCS engine is to verify that replicated state machine is consistent. This can be set by running the hadedbug command.</p> <ul style="list-style-type: none"> ■ Type and dimension: integer-scalar ■ Default: 0
ConnectorState (system use only)	<p>Indicates the state of the wide-area connector (wac). If 0, wac is not running. If 1, wac is running and communicating with the VCS engine.</p> <ul style="list-style-type: none"> ■ Type and dimension: integer-scalar ■ Default: Not applicable.

Table D-5 Cluster attributes (*continued*)

Cluster Attributes	Definition
CounterInterval (user-defined)	<p>Intervals counted by the attribute GlobalCounter indicating approximately how often a broadcast occurs that will cause the GlobalCounter attribute to increase.</p> <p>The default value of the GlobalCounter increment can be modified by changing CounterInterval. If you increase this attribute to exceed five seconds, consider increasing the default value of the ShutdownTimeout attribute.</p> <ul style="list-style-type: none"> ■ Type and dimension: integer-scalar ■ Default: 5
CounterMissAction (user-defined)	<p>Specifies the action that must be performed when the GlobalCounter is not updated for CounterMissTolerance times the CounterInterval. Possible values are LogOnly and Trigger. If you set CounterMissAction to LogOnly, the system logs the message in Engine Log and Syslog. If you set CounterMissAction to Trigger, the system invokes a trigger which has default action of collecting the comms tar file.</p> <ul style="list-style-type: none"> ■ Type and dimension: string-scalar ■ Default: LogOnly
CounterMissTolerance (user-defined)	<p>Specifies the time interval that can lapse since the last update of GlobalCounter before VCS reports an issue. If the GlobalCounter does not update within CounterMissTolerance times CounterInterval, VCS reports the issue. Depending on the CounterMissAction.value, appropriate action is performed.</p> <ul style="list-style-type: none"> ■ Type and dimension: integer-scalar ■ Default: 20
CredRenewFrequency (user-defined)	<p>The number of days after which the VCS engine renews its credentials with the authentication broker. For example, the value 5 indicates that credentials are renewed every 5 days; the value 0 indicates that credentials are not renewed.</p> <ul style="list-style-type: none"> ■ Type and dimension: integer-scalar ■ Default = 0
DeleteOnlineResource (user-defined)	<p>Defines whether you can delete online resources. Set this value to 1 to enable deletion of online resources. Set this value to 0 to disable deletion of online resources.</p> <p>You can override this behavior by using the -force option with the hares -delete command.</p> <ul style="list-style-type: none"> ■ Type and dimension: integer-scalar ■ Default = 1
DumpingMembership (system use only)	<p>Indicates that the engine is writing or dumping the configuration to disk.</p> <ul style="list-style-type: none"> ■ Type and dimension: vector ■ Default: Not applicable.

Table D-5 Cluster attributes (*continued*)

Cluster Attributes	Definition
EngineClass (user-defined)	<p>The scheduling class for the VCS engine (HAD).</p> <p>The attribute can take the following values:</p> <p>RT, TS</p> <p>where RT = realtime and TS = timeshare. For information on the significance of these values, see the operating system documentation.</p> <ul style="list-style-type: none">■ Type and dimension: string-scalar■ Default: RT
EnableFFDC (user-defined)	<p>Enables or disables FFDC logging. By default, FFDC logging is enabled.</p> <ul style="list-style-type: none">■ Type and dimension: boolean-scalar■ Default: 1
EnableVMAutoDiscovery (user-defined)	<p>Enables or disables auto discovery of virtual machines. By default, auto discovery of virtual machines is disabled.</p> <ul style="list-style-type: none">■ Type and dimension: integer-scalar■ Default: 0
EnablePBF (user-defined)	<p>Enables or disables priority based failover. When set to 1 (one), VCS gives priority to the online of high priority service group, by ensuring that its Load requirement is met on the system.</p> <ul style="list-style-type: none">■ Type and dimension: boolean-scalar■ Default: 0 (zero)
EnginePriority (user-defined)	<p>The priority in which HAD runs. Generally, a greater priority value indicates higher scheduling priority. A range of priority values is assigned to each scheduling class. For more information on the range of priority values, see the operating system documentation.</p> <ul style="list-style-type: none">■ Type and dimension: string-scalar■ Default: ""

Table D-5 Cluster attributes (*continued*)

Cluster Attributes	Definition
EngineShutdown (user-defined)	<p>Defines the options for the <code>hastop</code> command. The attribute can assume the following values:</p> <p>Enable—Process all <code>hastop</code> commands. This is the default behavior.</p> <p>Disable—Reject all <code>hastop</code> commands.</p> <p>DisableClusStop—Do not process the <code>hastop -all</code> command; process all other <code>hastop</code> commands.</p> <p>PromptClusStop—Prompt for user confirmation before running the <code>hastop -all</code> command; process all other <code>hastop</code> commands.</p> <p>PromptLocal—Prompt for user confirmation before running the <code>hastop -local</code> command; reject all other <code>hastop</code> commands.</p> <p>PromptAlways—Prompt for user confirmation before running any <code>hastop</code> command.</p> <ul style="list-style-type: none"> ■ Type and dimension: string-scalar ■ Default: Enable
FipsMode (system use only)	<p>Indicates whether FIPS mode is enabled for the cluster. The value depends on the mode of the broker on the system. If <code>FipsMode</code> is set to 1, FIPS mode is enabled. If <code>FipsMode</code> is set to 0, FIPS mode is disabled.</p> <ul style="list-style-type: none"> ■ Type and dimension: integer -scalar ■ Default: Not applicable <p>You can verify the value of <code>FipsMode</code> as follows:</p> <pre># haclus -value FipsMode</pre>
GlobalCounter (system use only)	<p>This counter increases incrementally by one for each counter interval. It increases when the broadcast is received.</p> <p>VCS uses the <code>GlobalCounter</code> attribute to measure the time it takes to shut down a system. By default, the <code>GlobalCounter</code> attribute is updated every five seconds. This default value, combined with the 600-second default value of the <code>ShutdownTimeout</code> attribute, means if system goes down within 120 increments of <code>GlobalCounter</code>, it is treated as a fault. Change the value of the <code>CounterInterval</code> attribute to modify the default value of <code>GlobalCounter</code> increment.</p> <ul style="list-style-type: none"> ■ Type and dimension: integer-scalar ■ Default: Not applicable

Table D-5 Cluster attributes (*continued*)

Cluster Attributes	Definition
Guests (user-defined)	<p>List of operating system user accounts that have Guest privileges on the cluster.</p> <p>This attribute is valid clusters running in secure mode.</p> <ul style="list-style-type: none"> ■ Type and dimension: string-keylist ■ Default: ""
GuestGroups (user-defined)	<p>List of operating system user groups that have Guest privilege on the cluster.</p> <ul style="list-style-type: none"> ■ Type and dimension: string-keylist ■ Default: Not applicable
DefaultGuestAccess (user-defined)	<p>Indicates whether any authenticated user should have guest access to the cluster by default. The default guest access can be:</p> <ul style="list-style-type: none"> ■ 0: Guest access for privileged users only. ■ 1: Guest access for everyone. ■ Type and dimension: boolean-scalar ■ Default: 0
GroupLimit (user-defined)	<p>Maximum number of service groups.</p> <ul style="list-style-type: none"> ■ Type and dimension: integer-scalar ■ Default: 200
HacliUserLevel (user-defined)	<p>This attribute has two, case-sensitive values:</p> <p>NONE—hacli is disabled for all users regardless of role.</p> <p>COMMANDROOT—hacli is enabled for root only.</p> <p>Note: The command <code>haclus -modify HacliUserLevel</code> can be executed by root only.</p> <ul style="list-style-type: none"> ■ Type and dimension: string-scalar ■ Default: NONE
HostAvailableMeters (System use only)	<p>Lists the meters that are available for measuring system resources. You cannot configure this attribute in the main.cf file.</p> <ul style="list-style-type: none"> ■ Type and dimension: string-association <p>Keys are the names of parameters and values are the names of meter libraries.</p> <ul style="list-style-type: none"> ■ Default: HostAvailableMeters = { CPU = "libmeterhost_cpu.so", Mem = "libmeterhost_mem.so", Swap = "libmeterhost_swap.so" }

Table D-5 Cluster attributes (*continued*)

Cluster Attributes	Definition
HostMeters (user-defined)	<p>Indicates the parameters (CPU, Mem, or Swap) that are currently metered in the cluster.</p> <ul style="list-style-type: none"> ■ Type and dimension: string-keylist ■ Default: HostMeters = {"CPU", "Mem", "Swap"} You can configure this attribute in the main.cf file. You cannot modify the value at run time. The keys must be one or more from CPU, Mem, or Swap.
LockMemory (user-defined)	<p>Controls the locking of VCS engine pages in memory. This attribute has the following values. Values are case-sensitive:</p> <p>ALL: Locks all current and future pages.</p> <p>CURRENT: Locks current pages.</p> <p>NONE: Does not lock any pages.</p> <p>On AIX, this attribute includes only one value, all, which is the default. This value locks text and data into memory (process lock).</p> <ul style="list-style-type: none"> ■ Type and dimension: string-scalar ■ Default: ALL
LogClusterUUID (user-defined)	<p>Enables or disables logging of the cluster UUID in each log message. By default, cluster UUID is not logged.</p> <ul style="list-style-type: none"> ■ Type and dimension: boolean-scalar ■ Default: 0
LogSize (user-defined)	<p>Indicates the size of engine log files in bytes.</p> <p>Minimum value is = 65536 (equal to 64KB) Maximum value = 134217728 (equal to 128MB)</p> <ul style="list-style-type: none"> ■ Type and dimension: integer-scalar ■ Default: 134217728 (128 MB)

Table D-5 Cluster attributes (*continued*)

Cluster Attributes	Definition
MeterControl (user-defined)	<p>Indicates the intervals at which metering and forecasting for the system attribute AvailableCapacity are done for the keys specified in HostMeters.</p> <ul style="list-style-type: none"> ■ Type and dimension: integer-association This attribute includes the following keys: ■ MeterInterval Frequency in seconds at which metering is done by the HostMonitor agent. The value for this key can equal or exceed 30. The default value is 120 indicating that the HostMonitor agent meters available capacity and updates the System attribute AvailableCapacity every 120 seconds. The HostMonitor agent checks for changes in the available capacity for every monitoring cycle and when there is a change, the HostMonitor agent updates the values in the same monitoring cycle. The MeterInterval value applies only if Statistics is set to Enabled or MeterHostOnly. ■ ForecastCycle The number of metering cycles after which forecasting of available capacity is done. The value for this key can equal or exceed 1. The default value is 3 indicating that forecasting of available capacity is done after every 3 metering cycles. Assuming the default MeterInterval value of 120 seconds, forecasting is done after 360 seconds or 6 minutes. The ForecastCycle value applies only if Statistics is set to Enabled. <p>You can configure this attribute in main.cf. You cannot modify the value at run time. The values of MeterInterval and ForecastCycle apply to all keys of HostMeters.</p>
MeterUnit	<p>Represents units for parameters that are metered.</p> <ul style="list-style-type: none"> ■ Type and dimension: string-association ■ Default: CPU=CPU, Mem = MB, Swap = MB} <p>You can configure this attribute in main.cf; if configured in main.cf, then it must contain units for all the keys as specified in HostMeters. You cannot modify the value at run time.</p> <p>When Statistics is set to Enabled then service group attribute Load, and the following system attributes are represented in corresponding units for parameters such as CPU, Mem, or Swap:</p> <ul style="list-style-type: none"> ■ AvailableCapacity ■ HostAvailableForecast ■ Capacity ■ ReservedCapacity <p>The values of keys such as Mem and Swap can be represented in MB or GB, and CPU can be represented in CPU, MHz or GHz.</p>

Table D-5 Cluster attributes (*continued*)

Cluster Attributes	Definition
MeterWeight (user-defined)	<p>Indicates the default meter weight for the service groups in the cluster. You can configure this attribute in the main.cf file, but you cannot modify the value at run time. If the attribute is defined in the main.cf file, it must have at least one key defined. The weight for the key must be in the range of 0 to 10. Only keys from HostAvailableMeters are allowed in this attribute.</p> <ul style="list-style-type: none"> ■ Type and dimension: integer-association ■ Default: {CPU = 10, Mem = 5, Swp = 1}
Notifier (system use only)	<p>Indicates the status of the notifier in the cluster; specifically:</p> <p>State—Current state of notifier, such as whether or not it is connected to VCS.</p> <p>Host—The host on which notifier is currently running or was last running. Default = None</p> <p>Severity—The severity level of messages queued by VCS for notifier. Values include Information, Warning, Error, and SevereError. Default = Warning</p> <p>Queue—The size of queue for messages queued by VCS for notifier.</p> <ul style="list-style-type: none"> ■ Type and dimension: string-association ■ Default: Different values for each parameter.
OpenExternalCommunicationPort (user-defined)	<p>Indicates whether communication over the external communication port for VCS is allowed or not. By default, the external communication port for VCS is 14141.</p> <ul style="list-style-type: none"> ■ Type and dimension: string-scalar ■ Valid values: YES, NO ■ Default: YES ■ YES: The external communication port for VCS is open. ■ NO: The external communication port for VCS is not open. <p>Note: When the external communication port for VCS is not open, RemoteGroup resources created by the RemoteGroup agent and users created by the <code>hawparsetup</code> command cannot access VCS.</p>
OperatorGroups (user-defined)	<p>List of operating system user groups that have Operator privileges on the cluster. This attribute is valid clusters running in secure mode.</p> <ul style="list-style-type: none"> ■ Type and dimension: string-keylist ■ Default: ""
Operators (user-defined)	<p>List of users with Cluster Operator privileges.</p> <ul style="list-style-type: none"> ■ Type and dimension: string-keylist ■ Default: ""

Table D-5 Cluster attributes (*continued*)

Cluster Attributes	Definition
PanicOnNoMem (user-defined)	<p>Indicate the action that you want VCS engine (HAD) to take if it cannot receive messages from GAB due to low-memory.</p> <ul style="list-style-type: none"> ■ If the value is 0, VCS exits with warnings. ■ If the value is 1, VCS calls the GAB library routine to panic the system. ■ Default: 0
PreferredFencingPolicy	<p>The I/O fencing race policy to determine the surviving subcluster in the event of a network partition. Valid values are Disabled, System, Group, or Site.</p> <p>Disabled: Preferred fencing is disabled. The fencing driver favors the subcluster with maximum number of nodes during the race for coordination points.</p> <p>System: The fencing driver gives preference to the system that is more powerful than others in terms of architecture, number of CPUs, or memory during the race for coordination points. VCS uses the system-level attribute FencingWeight to calculate the node weight.</p> <p>Group: The fencing driver gives preference to the node with higher priority service groups during the race for coordination points. VCS uses the group-level attribute Priority to determine the node weight.</p> <p>Site: The fencing driver gives preference to the node with higher site priority during the race for coordination points. VCS uses the site-level attribute Preference to determine the node weight.</p> <p>See “About preferred fencing” on page 319.</p> <ul style="list-style-type: none"> ■ Type and dimension: string-scalar ■ Default: "Disabled"
PrintMsg (user-defined)	<p>Enables logging TagM messages in engine log if set to 1.</p> <ul style="list-style-type: none"> ■ Type and dimension: boolean-scalar ■ Default: 0
ProcessClass (user-defined)	<p>Indicates the scheduling class processes created by the VCS engine. For example, triggers.</p> <ul style="list-style-type: none"> ■ Type and dimension: string-scalar ■ Default = TS
ProcessPriority (user-defined)	<p>The priority of processes created by the VCS engine. For example triggers.</p> <ul style="list-style-type: none"> ■ Type and dimension: string-scalar ■ Default: ""

Table D-5 Cluster attributes (*continued*)

Cluster Attributes	Definition
ReadOnly (user-defined)	<p>Indicates that cluster is in read-only mode.</p> <ul style="list-style-type: none"> ■ Type and dimension: integer-scalar ■ Default: 1
ResourceLimit (user-defined)	<p>Maximum number of resources.</p> <ul style="list-style-type: none"> ■ Type and dimension: integer-scalar ■ Default: 5000
SecInfo (user-defined)	<p>Enables creation of secure passwords, when the SecInfo attribute is added to the <code>main.cf</code> file with the security key as the value of the attribute.</p> <ul style="list-style-type: none"> ■ Type and dimension: string-scalar ■ Default: "" <p>See "Encrypting agent passwords" on page 176.</p>
SecInfoLevel (user-defined)	<p>Denotes the password encryption privilege level.</p> <ul style="list-style-type: none"> ■ Type and dimension: string-scalar ■ Default: R <p>See "Encrypting agent passwords" on page 176.</p>
SecureClus (user-defined)	<p>Indicates whether the cluster runs in secure mode. The value 1 indicates the cluster runs in secure mode. This attribute cannot be modified when VCS is running.</p> <ul style="list-style-type: none"> ■ Type and dimension: boolean-scalar ■ Default: 0
SiteAware (user-defined)	<p>Indicates whether sites are configured for a cluster or not.</p> <ul style="list-style-type: none"> ■ Type and dimension: boolean-scalar ■ Default: 0 <p>Possible values are:</p> <ul style="list-style-type: none"> ■ 1: Sites are configured. ■ 0: Sites are not configured. <p>You can configure a site from Veritas InfoScale Operations Manager . This attribute will be automatically set to 1 when configured using Veritas InfoScale Operations Manager. If site information is not configured for some nodes in the cluster, those nodes are placed under a default site that has the lowest preference.</p> <p>See "Site attributes" on page 851.</p>

Table D-5 Cluster attributes (*continued*)

Cluster Attributes	Definition
SourceFile (user-defined)	<p>File from which the configuration is read. Do not configure this attribute in main.cf.</p> <p>Make sure the path exists on all nodes before running a command that configures this attribute.</p> <ul style="list-style-type: none"> ■ Type and dimension: string-scalar ■ Default: Not applicable.
Statistics (user-defined)	<p>Indicates if statistics gathering is enabled and whether the FailOverPolicy can be set to BiggestAvailable.</p> <ul style="list-style-type: none"> ■ Type and dimension: string-scalar ■ Default: Enabled <p>You cannot modify the value at run time.</p> <p>Possible values are:</p> <ul style="list-style-type: none"> ■ Enabled: The HostMonitor agent meters host utilization and forecasts the available capacity for the systems in the cluster. With this value set, FailOverPolicy for any service group cannot be set to Load. ■ MeterHostOnly: The HostMonitor agent meters host utilization but it does not forecast the available capacity for the systems in the cluster. The service group attribute FailOverPolicy cannot be set to BiggestAvailable. ■ Disabled: The HostMonitor agent is not started. Both metering of host utilization and forecasting of available capacity are disabled. The service group attribute FailOverPolicy cannot be set to BiggestAvailable. <p>See “Service group attributes” on page 789.</p>
Stewards (user-defined)	<p>The IP address and hostname of systems running the steward process.</p> <ul style="list-style-type: none"> ■ Type and dimension: string-keylist ■ {}

Table D-5 Cluster attributes (*continued*)

Cluster Attributes	Definition
SystemRebootAction (user-defined)	<p>Determines whether frozen service groups are ignored on system reboot.</p> <ul style="list-style-type: none"> ■ Type and dimension: string-keylist ■ Default: "" <p>If the SystemRebootAction value is IgnoreFrozenGroup, VCS ignores service groups that are frozen (TFrozen and Frozen) and takes the remaining service groups offline. If the frozen service groups have firm dependencies or hard dependencies on any other service groups which are not frozen, VCS gives an error.</p> <p>If the SystemRebootAction value is "", VCS tries to take all service groups offline. Because VCS cannot be gracefully stopped on a node where a frozen service group is online, applications on the node might get killed.</p> <p>Note: The SystemRebootAction attribute applies only on system reboot and system shutdown.</p>
TypeLimit (user-defined)	<p>Maximum number of resource types.</p> <ul style="list-style-type: none"> ■ Type and dimension: integer-scalar ■ Default: 100
UseFence (user-defined)	<p>Indicates whether the cluster uses SCSI-3 I/O fencing.</p> <p>The value SCSI3 indicates that the cluster uses either disk-based or server-based I/O fencing. The value NONE indicates it does not use either.</p> <ul style="list-style-type: none"> ■ Type and dimension: string-scalar ■ Default: NONE
UserNames (user-defined)	<p>List of VCS users. The installer uses <code>admin</code> as the default user name.</p> <ul style="list-style-type: none"> ■ Type and dimension: string-association ■ Default: ""
VCSFeatures (system use only)	<p>Indicates which VCS features are enabled. Possible values are:</p> <p>0—No features are enabled (VCS Simulator)</p> <p>1—L3+ is enabled</p> <p>2—Global Cluster Option is enabled</p> <p>Even though the VCSFeatures is an integer attribute, when you query the value with the <code>haclus -value</code> command or the <code>haclus -display</code> command, it displays as the string L10N for value 1 and DR for value 2.</p> <ul style="list-style-type: none"> ■ Type and dimension: integer-scalar ■ Default: Not applicable.

Table D-5 Cluster attributes (*continued*)

Cluster Attributes	Definition
VCSType (system use only)	Denotes the mode for which VCS is licensed. Even though the VCSType is an integer attribute, when you query the value with the <code>haclus -value</code> command or the <code>haclus -display</code> command, it displays as the string UNKNOWN_MODE for value 0 and VCS for value 7. <ul style="list-style-type: none"> ■ Type and dimension: integer-scalar ■ Default: Not applicable
WACPort (user-defined)	The TCP port on which the <code>wac</code> (Wide-Area Connector) process on the local cluster listens for connection from remote clusters. Type and dimension: integer-scalar <ul style="list-style-type: none"> ■ Default: 14155

Heartbeat attributes (for global clusters)

[Table D-6](#) lists the heartbeat attributes. These attributes apply to global clusters.

Table D-6 Heartbeat attributes

Heartbeat Attributes	Definition
AgentState (system use only)	The state of the heartbeat agent. <ul style="list-style-type: none"> ■ Type and dimension: integer-scalar ■ Default: INIT
Arguments (user-defined)	List of arguments to be passed to the agent functions. For the <code>lcmp</code> agent, this attribute can be the IP address of the remote cluster. <ul style="list-style-type: none"> ■ Type and dimension: string-vector ■ Default: ""
AYAInterval (user-defined)	The interval in seconds between two heartbeats. <ul style="list-style-type: none"> ■ Type and dimension: integer-scalar ■ Default: 60 seconds
AYARetryLimit (user-defined)	The maximum number of lost heartbeats before the agent reports that heartbeat to the cluster is down. <ul style="list-style-type: none"> ■ Type and dimension: integer-scalar ■ Default: 3

Table D-6 Heartbeat attributes (*continued*)

Heartbeat Attributes	Definition
AYATimeout (user-defined)	<p>The maximum time (in seconds) that the agent will wait for a heartbeat AYA function to return ALIVE or DOWN before being canceled.</p> <ul style="list-style-type: none"> ■ Type and dimension: integer-scalar ■ Default: 30
CleanTimeOut (user-defined)	<p>Number of seconds within which the Clean function must complete or be canceled.</p> <ul style="list-style-type: none"> ■ Type and dimension: integer-scalar ■ Default: 300 seconds
ClusterList (user-defined)	<p>List of remote clusters.</p> <ul style="list-style-type: none"> ■ Type and dimension: string-keylist ■ Default: ""
InitTimeout (user-defined)	<p>Number of seconds within which the Initialize function must complete or be canceled.</p> <ul style="list-style-type: none"> ■ Type and dimension: integer-scalar ■ Default: 300 seconds
LogDbg (user-defined)	<p>The log level for the heartbeat.</p> <ul style="list-style-type: none"> ■ Type and dimension: string-keylist ■ Default: ""
State	<p>The state of the heartbeat.</p> <ul style="list-style-type: none"> ■ Type and dimension: integer-scalar ■ Default: Not applicable
StartTimeout (user-defined)	<p>Number of seconds within which the Start function must complete or be canceled.</p> <ul style="list-style-type: none"> ■ Type and dimension: integer-scalar ■ Default: 300 seconds
StopTimeout (user-defined)	<p>Number of seconds within which the Stop function must complete or be canceled without stopping the heartbeat.</p> <ul style="list-style-type: none"> ■ Type and dimension: integer-scalar ■ Default: 300 seconds

Remote cluster attributes

[Table D-7](#) lists the RemoteCluster attributes. These attributes apply to remote clusters.

Table D-7 Remote cluster attributes

Remote cluster Attributes	Definition
AdministratorGroups (system use only)	List of operating system user account groups that have administrative privileges on the cluster. This attribute applies to clusters running in secure mode. <ul style="list-style-type: none">■ Type and dimension: string-keylist■ Default: " "
Administrators (system use only)	Contains list of users with Administrator privileges. <ul style="list-style-type: none">■ Type and dimension: string-keylist■ Default: ""
CID (system use only)	The CID of the remote cluster. See “Cluster attributes” on page 831.
ClusState (system use only)	Indicates the current state of the remote cluster as perceived by the local cluster. <ul style="list-style-type: none">■ Type and dimension: integer-scalar■ Default: Not applicable
ClusterAddress (user-defined)	Specifies the remote cluster's virtual IP address, which is used to connect to the remote cluster by the local cluster. <ul style="list-style-type: none">■ Type and dimension: string-scalar■ Default: ""
ClusterName (system use only)	The name of cluster. <ul style="list-style-type: none">■ Type and dimension: string-scalar■ Default: ""
ClusterUUID (system use only)	Unique ID assigned to the cluster by Availability Manager. <ul style="list-style-type: none">■ Type and dimension: string-scalar■ Default: Not applicable

Table D-7 Remote cluster attributes (*continued*)

Remote cluster Attributes	Definition
ConnectTimeout (user-defined)	Specifies the time in milliseconds for establishing the WAC to WAC connection. <ul style="list-style-type: none"> ■ Type and dimension: integer-scalar ■ Default: 300
DeclaredState (user-defined)	Specifies the declared state of the remote cluster after its cluster state is transitioned to FAULTED. See “Disaster declaration” on page 736. <ul style="list-style-type: none"> ■ Type and dimension: string-scalar ■ Default: "" The value can be set to one of the following values: <ul style="list-style-type: none"> ■ Disaster ■ Outage ■ Disconnect ■ Replica
EngineVersion (system use only)	Specifies the major, minor, maintenance-patch, and point-patch version of VCS. The value of EngineVersion attribute is in hexa-decimal format. To retrieve version information: <pre>Major Version: EngineVersion >> 24 & 0xff Minor Version: EngineVersion >> 16 & 0xff Maint Patch: EngineVersion >> 8 & 0xff Point Patch: EngineVersion & 0xff</pre> <ul style="list-style-type: none"> ■ Type and dimension: integer-scalar ■ Default: Not applicable
Guests (system use only)	List of operating system user accounts that have Guest privileges on the cluster. This attribute is valid for clusters running in secure mode. <ul style="list-style-type: none"> ■ Type and dimension: string-keylist ■ Default: ""

Table D-7 Remote cluster attributes (*continued*)

Remote cluster Attributes	Definition
OperatorGroups (system use only)	List of operating system user groups that have Operator privileges on the cluster. This attribute is valid for clusters running in secure mode. <ul style="list-style-type: none">■ Type and dimension: string-keylist■ Default: 300 seconds
Operators (system use only)	List of users with Cluster Operator privileges. <ul style="list-style-type: none">■ Type and dimension: string-keylist■ Default: ""
RemoteConnectInterval (user-defined)	Specifies the time in seconds between two successive attempts to connect to the remote cluster. <ul style="list-style-type: none">■ Type and dimension: integer-scalar■ Default: 5
SocketTimeout (user-defined)	Specifies the time in seconds for WAC to WAC heartbeat. If no IAA is received in the specified time, connection with the remote WAC is assumed to be broken. <ul style="list-style-type: none">■ Type and dimension: integer-scalar■ Default: 180
SourceFile (system use only)	File from which the configuration is read. Do not configure this attribute in main.cf. Make sure the path exists on all nodes before running a command that configures this attribute. <ul style="list-style-type: none">■ Type and dimension: string-scalar■ Default: Not applicable.

Table D-7 Remote cluster attributes (*continued*)

Remote cluster Attributes	Definition
VCSFeatures (system use only)	<p>Indicates which VCS features are enabled. Possible values are:</p> <p>0—No features are enabled (VCS Simulator)</p> <p>1—L3+ is enabled</p> <p>2—Global Cluster Option is enabled</p> <p>Even though the VCSFeatures is an integer attribute, when you query the value with the <code>haclus -value</code> command or the <code>haclus -display</code> command, it displays as the string L10N for value 1 and DR for value 2.</p> <ul style="list-style-type: none"> ■ Type and dimension: integer-scalar ■ Default: Not applicable.
VCSMode (system use only)	<p>Denotes the mode for which VCS is licensed.</p> <p>Even though the VCSMode is an integer attribute, when you query the value with the <code>haclus -value</code> command or the <code>haclus -display</code> command, it displays as the string UNKNOWN_MODE for value 0 and VCS for value 7.</p> <ul style="list-style-type: none"> ■ Type and dimension: integer-scalar ■ Default: Not applicable
WACPort (system use only)	<p>The TCP port on which the <code>wac</code> (Wide-Area Connector) process on the remote cluster listens for connection from other clusters.</p> <ul style="list-style-type: none"> ■ Type and dimension: integer-scalar ■ Default: 14155

Site attributes

Table D-8 lists the site attributes.

Table D-8 Site attributes

Site Attributes	Definition										
Preference (user-defined)	<p>Indicates the preference for a site.</p> <ul style="list-style-type: none">■ Type and dimension : integer-scalar■ Default : 3 <p>If preferred fencing is enabled, I/O fencing uses the Preference value to compute node weight as follows:</p> <table border="1" data-bbox="487 552 806 782"><thead><tr><th>Preference</th><th>Node weight</th></tr></thead><tbody><tr><td>1</td><td>10000</td></tr><tr><td>2</td><td>1000</td></tr><tr><td>3</td><td>100</td></tr><tr><td>4</td><td>10</td></tr></tbody></table>	Preference	Node weight	1	10000	2	1000	3	100	4	10
Preference	Node weight										
1	10000										
2	1000										
3	100										
4	10										
SystemList (user-defined)	<p>Indicates the list of systems configured under a site.</p> <ul style="list-style-type: none">■ Type and dimension : string-keylist■ Default : ""										

Accessibility and VCS

This appendix includes the following topics:

- [About accessibility in VCS](#)
- [Navigation and keyboard shortcuts](#)
- [Support for accessibility settings](#)
- [Support for assistive technologies](#)

About accessibility in VCS

Veritas InfoScale products meet federal accessibility requirements for software as defined in Section 508 of the Rehabilitation Act:

<http://www.access-board.gov/508.htm>

Cluster Server provides shortcuts for major graphical user interface (GUI) operations and menu items. Cluster Server is compatible with operating system accessibility settings as well as a variety of assistive technologies. All manuals also are provided as accessible PDF files, and the online help is provided as HTML, which appears in a compliant viewer.

Navigation and keyboard shortcuts

VCS uses standard operating system navigation keys and keyboard shortcuts. For its unique functions, VCS uses its own navigation keys and keyboard shortcuts which are documented below.

Navigation in the Java Console

[Table E-1](#) lists keyboard navigation rules and shortcuts used in Cluster Manager (Java Console), in addition to those provided by the operating system.

Table E-1 Keyboard inputs and shortcuts

VCS keyboard input	Result
[Shift F10]	Opens a context-sensitive pop-up menu
[Spacebar]	Selects an item
[Ctrl Tab]	Navigates outside a table
[F2]	Enables editing a cell

Navigation in the Web console

The Web console supports standard browser-based navigation and shortcut keys for supported browsers.

All Veritas GUIs use the following keyboard navigation standards:

- Tab moves the cursor to the next active area, field, or control, following a preset sequence.
- Shift+Tab moves the cursor in the reverse direction through the sequence.
- Up-arrow and Down-arrow keys move the cursor up and down the items of a list.
- Either Enter or the Spacebar activates your selection. For example, after pressing Tab to select Next in a wizard panel, press the Spacebar to display the next screen.

Support for accessibility settings

Veritas software responds to operating system accessibility settings.

On UNIX systems, you can change the accessibility settings by using desktop preferences or desktop controls.

Support for assistive technologies

Veritas provides support for assistive technologies as follows:

- Cluster Manager (Java Console) is compatible with JAWS 4.5.
- Though graphics in the documentation can be read by screen readers, setting your screen reader to ignore graphics may improve performance.
- Veritas has not tested screen readers for languages other than English.

Index

Symbols

- remove cluster 627

A

- about

 - Veritas InfoScale Operations Manager 49

- accessibility

 - assistive technology support 854

 - overview 853

- ActionTimeout attribute 789

- ActiveCount attribute 816

- AdaptiveHA

 - about 424

 - enabling 424

 - Limitations 427

- administering

 - LLT 181

- AdministratorGroups attribute

 - for clusters 846

 - for service groups 816

- Administrators attribute

 - for clusters 846

 - for service groups 816

- AdvDbg attribute 789

- agent log

 - format 691

 - location 691

- AgentClass attribute 789

- AgentDirectory attribute 789

- AgentFailedOn attribute 789

- AgentFile attribute 789

- AgentPriority attribute 789

- AgentReplyTimeout attribute 789

- agents

 - classifications of 43

 - entry points 39

 - framework 44

 - functions 39

 - Heartbeat 560

 - IMF 44

 - impact on performance 654

- agents (*continued*)

 - intelligent monitoring framework 44

 - intelligent resource monitoring 40

 - poll-based resource monitoring 40

 - starting from command line 221

 - stopping from command line 221

 - Wide-Area Heartbeat 560

- AgentStartTimeout attribute 789

- AgentState attribute 847

- AgentStopped attribute 831

- AlertOnMonitorTimeouts attribute 789

- alerts

 - deleting from Java Console 171

 - monitoring from Java Console 170

- AMF driver 47

- App.DisplayName 553

- App.RestartAttempts 553

- App.StartStopTimeout 553

- ArgList attribute 789

- ArgListValues attribute 773

- assistive technology support 854

- association attribute dimension 70

- asymmetric configuration 52

- AttrChangedTimeout attribute 789

- attribute dimensions

 - association 70

 - keylist 70

 - scalar 70

 - vector 70

- attribute types

 - boolean 69

 - integer 69

 - string 69

- attributes

 - about 69

 - editing from Java Console 163

 - for clusters 831

 - for heartbeats 846

 - for resource types 773, 789

 - for resources 764

 - for service groups 789

 - for systems 816

attributes *(continued)*
 local and global 72
 overriding from command line 238
 overriding from Java Console 151
 Remote cluster 848
 authentication broker 47
 Authority attribute
 about 560
 definition 816
 AuthorizationControl attribute 846
 AutoAddSystemtoCSG attribute 846
 AutoclearLimit attribute
 for service groups 816
 AutoClearQ attribute 846
 AutoDisabled attribute 816
 AutoFailOver attribute
 about 422
 definition 816
 AutoRestart attribute 816
 AutoStart attribute
 for resources 773
 for service groups 816
 AutoStartIfPartial attribute 816
 AutoStartList attribute 816
 AutoStartPolicy attribute 816
 AutoStartTimeout attribute 846
 AvailableCapacity attribute 831

B

BackupInterval attribute 846
 BiggestAvailable 424
 binary message catalogs
 about 700
 location of 700
 boolean attribute type 69
 bundled agents 43

C

Capacity attribute 831
 CapacityReserved attribute 816
 CleanRetryLimit attribute 789
 CleanTimeout attribute 789
 client process
 detecting failure 660
 CloseTimeout attribute 789
 ClusState attribute 846
 Cluster Administrator
 about 83

Cluster Administrator *(continued)*
 adding user as 198
 cluster attributes 831
 Cluster Explorer
 about 102
 accessing 102
 adding resources 144
 adding service groups 127
 adding systems 159
 adding users 124
 autoenabling service groups 137
 bringing resources online 149
 bringing service groups online 131
 changing user passwords 125
 changing user privileges 126
 clearing resource faults 153
 clearing ResourceInfo attribute 157
 closing configuration files 162
 Cluster Query 117
 Command Center 116
 configuration tree 105
 deleting resources 149
 deleting service groups 130
 deleting users 124
 disabling resources 153
 disabling service groups 136
 editing attributes 163
 enabling resources 152
 enabling service groups 135
 flushing service groups 137
 freezing service groups 134
 freezing systems 160
 importing resource types 158
 linking resources 154
 linking service groups 138
 logs 168
 modifying system lists for service groups 115
 monitoring group dependencies 109
 monitoring resource dependencies 110
 Notifier Wizard 117
 opening configuration files 161
 probing resources 151
 Properties view 107
 refreshing ResourceInfo attribute 157
 Remote Cluster Status View 113
 Resource View 110
 running HA fire drill 158
 saving configuration files 162
 service group configuration wizard 141

- Cluster Explorer *(continued)*
 - Service Group View 109
 - Status View 106
 - switching service groups 134
 - System Connectivity View 112
 - System Manager 115
 - taking resources offline 150
 - taking resources offline and propagating 150
 - taking service groups offline 132
 - tear-off view 105
 - Template View 114
 - toolbar 103
 - unfreezing service groups 135
 - unfreezing systems 161
 - unlinking resources 155
 - unlinking service groups 139
 - User Manager 115
 - view panel 105
- Cluster Guest
 - about 83
 - adding user as 198
- Cluster Manager (Java Console).. See Java Console
- Cluster Monitor
 - about 97
 - adding clusters 120
 - administering 120
 - behavior during failover 99
 - collapsing displays 100
 - configuring existing panels 121
 - configuring new panels 120
 - icon colors 99
 - logging off a cluster 123
 - logging on to a cluster 121
 - menus 97
 - monitoring cluster connection 99
 - monitoring cluster objects 99
 - panels 98
 - pausing scrolling panels 100
 - toolbar 97
- cluster name
 - changing in global configuration 626
- Cluster Operator
 - about 83
 - adding user as 198
- Cluster Query
 - in Java Console 117
- ClusterAddress attribute 846
- ClusterFailOverPolicy attribute 816
- clustering
 - criteria for data storage 30
 - criteria for monitor procedure 29
 - criteria for start procedure 29
 - criteria for stop procedure 29
 - license and host name issues 31
- ClusterList attribute 816
- ClusterLocation attribute 846
- ClusterName attribute 846
- ClusterOwner attribute 846
- ClusterRecipients attribute 846
- clusters
 - administering from Java Console 161
 - connecting to Cluster Monitor 120
- ClusterTime attribute 846
- ClusterUUID attribute 846
- Command Center
 - accessing 116
 - adding resources 145
 - adding service groups 129
 - adding systems 160
 - autoenabling service groups 137
 - bringing resources online 149
 - bringing service groups online 132
 - clearing resource faults 153
 - closing configuration files 162
 - deleting resources 149
 - deleting service groups 131
 - deleting systems 160
 - disabling resources 153
 - disabling service groups 136
 - editing attributes 163
 - enabling resources 152
 - enabling service groups 136
 - executing commands 162
 - flushing service groups 138
 - freezing service groups 134
 - freezing systems 160
 - ignoreparent option 151
 - linking resources 154
 - linking service groups 139
 - opening configuration files 161
 - probing resources 151
 - saving configuration files 162
 - switching service groups 134
 - taking resources offline 150
 - taking resources offline and propagating 150
 - taking service groups offline 133
 - unfreezing service groups 135

- Command Center *(continued)*
 - unfreezing systems 161
 - unlinking resources 156
 - unlinking service groups 140
 - commands
 - scripting 250
 - CompareRSM attribute 846
 - ComputeStats attribute 773
 - Concurrency
 - preventing violation 433
 - conditional statements 209
 - ConfidenceLevel attribute 773
 - ConfigBlockCount attribute 831
 - ConfigChecksum attribute 831
 - ConfigDiskState attribute 831
 - ConfigFile attribute 831
 - ConfigInfoCnt attribute 831
 - ConfigModDate attribute 831
 - configuration
 - closing from Java Console 162
 - dumping 196
 - opening from Java Console 161
 - saving 196
 - saving from Java Console 161
 - setting to read-only 196
 - setting to read/write 197
 - taking snapshots of 197
 - verifying 195
 - configuration files
 - generating 63
 - main.cf 63
 - read/write to read-only 200, 202, 204–205, 207–208, 215, 217
 - restoring from snapshots 197
 - taking snapshots of 197
 - types.cf 63
 - configuration language
 - local and global attributes 72
 - configurations
 - asymmetric 52
 - global cluster 60
 - N+1 55
 - N-to-1 54
 - N-to-N 56
 - replicated data 59
 - shared nothing 59
 - shared storage/replicated data 59
 - symmetric 53
 - ConflInterval attribute
 - about 440
 - definition 789
 - ConnectorState attribute 846
 - ContainerInfo attribute 816
 - ContainerOpts attribute 789
 - coordinator disks 321
 - DMP devices 318
 - for I/O fencing 318
 - CounterInterval attribute 846
 - CounterMissAction attribute 846
 - CounterMissTolerance attribute 846
 - CP server
 - cloning 389
 - deployment scenarios 402
 - migration scenarios 402
 - CP server database 330
 - CP server user privileges 335
 - CPU binding of HAD 665
 - CPUBinding attribute 831
 - Critical attribute 773
 - CurrentCount attribute 816
 - CurrentLimits attribute 831
 - custom agents
 - about 43
- ## D
- Daemon Down Node Alive 350
 - DDNA 350
 - DefaultGuestAccess attribute 846
 - DeferAutoStart attribute 816
 - DeleteOnlineResource attribute 846
 - dependencies
 - for resources 35
 - for service groups 475
 - disability compliance
 - in Java Console 91
 - DisableFaultMessages attribute 816
 - DiskHbStatus attribute 831
 - dumping a configuration 196
 - DumpingMembership attribute 846
 - dumptunables event trigger 517
 - dynamic application placement
 - FailOverPolicy attribute 424
 - DynamicLoad attribute 831

E

- Enabled attribute
 - for resources 773
 - for service groups 816
- EnableFFDC attribute 846
- EnablePBF attribute 846
- EnableVMAutoDiscovery attribute 846
- engine log
 - format 691
 - location 691
- EngineClass attribute 846
- EnginePriority attribute 846
- enterprise agents
 - about 43
- entry points
 - about 39
 - modifying for performance 654
- environment variables 73
- EPClass attribute 789
- EPPriority attribute 789
- error messages
 - agent log 691
 - at startup 709
 - engine log 691
 - message catalogs 700
- EvacList attribute 816
- Evacuate attribute 816
- Evacuating attribute 816
- EvacuatingForGroup attribute 816
- event triggers
 - about 515
 - dump tunables 517
 - globalcounter_not_updated 517
 - injeopardy 518
 - loadwarning 518
 - location of 516
 - multinick 519
 - nofailover 520
 - postoffline 520
 - postonline 521
 - preonline 521
 - resadminwait 522
 - resnotoff 524
 - resrestart 524
 - resstatechange 525
 - sysjoin 527
 - sysoffline 526
 - sysup 527
 - unable_to_restart_had 527–528

- event triggers (*continued*)
 - using 516
 - violation 528
- ExternalStateChange attribute 789

F

- failback
 - about 54
- Failover attribute 816
- FailOverPolicy attribute 816
- FaultOnMonitorTimeouts attribute 789
- FaultPropagation attribute 789
- FencingWeight 831
- FipsMode attribute 846
- fire drills
 - about 584
 - disaster recovery 584
 - for global clusters 584
 - for replicated data clusters 635
- FireDrill attribute 789
- Flags attribute 773
- FromQ attribute 816
- Frozen attribute
 - for service groups 816
 - for systems 831

G

- GAB
 - about 46, 310
 - impact on performance 653
 - tunable parameters 677
 - when a system panics 660
- GAB tunable parameters
 - dynamic 680
 - Control port seed 680
 - Driver state 680
 - Gab queue limit 680
 - Halt on process death 680
 - Halt on rejoin 680
 - IOFENCE timeout 680
 - Isolate timeout 680
 - Keep on killing 680
 - Kill_ntries 680
 - Missed heartbeat halt 680
 - Partition arbitration 680
 - Quorum flag 680
 - Stable timeout 680

- GAB tunable parameters *(continued)*
 - static 678
 - gab_conn_wait 678
 - gab_flowctrl 678
 - gab_isolate_time 678
 - gab_kill_ntries 678
 - gab_logbufsize 678
 - gab_msglogsize 678
 - gab_numnids 678
 - gab_numports 678
 - gab_timer_pri 678
 - gab_isolate_time timer 660
 - global attributes 72
 - global cluster configuration 60
 - global clusters
 - adding from Java Console 600
 - bringing remote groups online 610
 - deleting from Java Console 604
 - operation 556
 - switching remote groups 611
 - global heartbeats
 - administering from command line 627
 - administering from Java Console 611
 - deleting from Java Console 613
 - modifying from Java Console 612
 - global service groups
 - administering from command line 622
 - administering from Java Console 607
 - querying from command line 615
 - GlobalCounter attribute 846
 - globalcounter_not_updated event trigger 517
 - Group Administrator
 - about 83
 - adding user as 199
 - Group attribute 773
 - group dependencies.. *See* service group dependencies
 - Group Membership Services/Atomic Broadcast (GAB) 46
 - Group Operator
 - about 83
 - adding user as 199
 - GroupLimit attribute 846
 - GroupOwner attribute 816
 - GroupRecipients attribute 816
 - GuestGroups attribute 846
 - Guests attribute
 - for clusters 846
 - for service groups 816
 - GUI. 91
 - GUIIPAddr attribute 831
- ## H
- HA fire drill
 - about 299
 - haagent -display command 205
 - haagent -list command 210
 - haattr -add command 224
 - haattr -default command 225
 - haattr -delete command 224
 - hacf -verify command 195
 - hacf utility
 - creating multiple .cf files 195
 - HaciUserLevel attribute
 - about 83
 - definition 846
 - haclus -add command 624
 - haclus -declare command 624
 - haclus -delete command 624
 - haclus -display command
 - for global clusters 619
 - for local clusters 207
 - haclus -list command 619
 - haclus -modify command 624
 - haclus -state command 619
 - haclus -status command 620
 - haclus -value command
 - for global clusters 619
 - for local clusters 207
 - haclus -wait command 250
 - haconf -dump -makero command 196
 - haconf -makerw command 197
 - HAD
 - about 44
 - binding to CPU 665
 - impact on performance 653
 - had -v command 244
 - had -version command 244
 - HAD diagnostics 702
 - hagrp -add command 211
 - hagrp -clear command 218–219
 - hagrp -delete command 211
 - hagrp -dep command 202
 - hagrp -disable command 217
 - hagrp -disableresources command 217
 - hagrp -display command
 - for global clusters 616
 - for local clusters 202

- hagrp -enable command 216
- hagrp -enableresources command 217
- hagrp -forecast command
 - forecasting target system 203
- hagrp -freeze command 216
- hagrp -link command 221
- hagrp -list command
 - for global clusters 616
 - for local clusters 210
- hagrp -modify command 212
- hagrp -offline command
 - for global clusters 622
 - for local clusters 214
- hagrp -online command
 - for global clusters 622
 - for local clusters 213
- hagrp -resources command 202
- hagrp -state command
 - for global clusters 616
 - for local clusters 202
- hagrp -switch command
 - for global clusters 622
 - for local clusters 215
- hagrp -unfreeze command 216
- hagrp -unlink command 221
- hagrp -value command 615
- hagrp -wait command 250
- hahb -add command 627
- hahb -delete command 627
- hahb -display command 621
- hahb -global command 627
- hahb -list command 620
- hahb -local command 627
- hahb -modify command 627
- hahb command 627
- halogin command 194
- hamsg -info command 208
- hamsg -list command 208
- hanotify utility 503
- hares -action command 624
- hares -add command 222
- hares -clear command 237
- hares -delete command 223
- hares -dep command 203
- hares -display command
 - for global clusters 617
 - for local clusters 203
- hares -global command 227
- hares -info command 624
- hares -link command 235
- hares -list command
 - for global clusters 617
 - for local clusters 210
- hares -local command 225
- hares -modify command 223
- hares -offline command 236
- hares -offprop command 236
- hares -online command 236
- hares -override command 238
- hares -probe command 237
- hares -state command 617
- hares -undo_override command 238
- hares -unlink command 235
- hares -value command 617
- hares -wait command 250
- hashadow process 44
- hastart command 189
- hastatus -group command 207–208
- hastatus -summary command 208
- hastatus command
 - for global clusters 620
 - for local clusters 207
- hastop command 191
- hasys -display command
 - for global clusters 618
 - for local clusters 206
- hasys -force command 189
- hasys -freeze command 241
- hasys -list command
 - for global clusters 618
 - for local clusters 206
- hasys -modify command 240
- hasys -nodeid command 240
- hasys -state command 618
- hasys -unfreeze command 241, 244
- hasys -utilization command
 - for local clusters 206
- hasys -value command
 - for global clusters 618
- hasys -wait command 250
- hatype -add command 237
- hatype -delete command 237
- hatype -display command 205
- hatype -list command 204
- hatype -modify command 237
- hatype -resources command 205
- hauser -add command 199
- hauser -addpriv command 199–200

- hauser -delete command 201
- hauser -delpriv command 200–201
- hauser -display command 201
- hauser -list command 201
- Heartbeat agent 560
- heartbeat attributes 846
- heartbeats
 - modifying for global clusters 627
- host name issues 31
- HostAvailableForecast attribute 831
- HostAvailableMeters attribute 846
- HostMeters attribute 846
- HostMonitor attribute 831
- HostUtilization attribute 831

I

- I/O fencing
 - about 47
 - testing and scenarios 345
- icons
 - colors of 99
 - in Java Console 95
- include clauses
 - about 63
- InfoInterval attribute 789
- InfoTimeout attribute 789
- injeopardy event trigger 518
- integer attribute type 69
- intelligent resource monitoring
 - disabling manually 227
 - disabling using script 229
 - enabling manually 227
 - enabling using script 229
- IntentionalOnlineList attribute 816
- IntentOnline attribute 816
- Istate attribute 773

J

- Java Console
 - administering clusters 91
 - administering logs 168
 - administering resources 144
 - administering service groups 127
 - administering systems 159
 - administering user profiles 123
 - arranging icons 111
 - Cluster Explorer 102
 - Cluster Manager 95

- Java Console (*continued*)
 - Cluster Monitor 97
 - Cluster Query 117
 - components of 95
 - customizing display 100
 - disability compliance 91
 - icons 95
 - impact on performance 655
 - logging off a cluster 123
 - logging on to a cluster 121
 - overview 91
 - running commands from 162
 - running virtual fire drill 158
 - setting initial display 93
 - starting 94
 - user profiles 123
 - using with ssh 93
 - viewing server credentials 119
 - viewing user credentials 119
- Java Console views
 - Properties 107
 - Remote Cluster Status 113
 - Resource 110
 - Service Group 109
 - Status 106
 - System Connectivity 112
 - tear-off option 105

K

- keyless license
 - changing product level 180
 - product level 180
 - setting product level 180
- keylist attribute dimension 70
- keywords 73
 - list of 73

L

- LastOnline attribute 773
- LastSuccess attribute 816
- license keys
 - about 180
 - installing 180
 - troubleshooting 739
- LicenseType attribute 831
- licensing issues 31
- Limits attribute 831
- LinkHbStatus attribute 831

- LLT 46
 - about 311
 - tunable parameters 670
- LLT timer tunable parameters
 - setting 677
- LLTNodeId attribute 831
- Load attribute 816
- Load policy for SGWM 424
- LoadTimeCounter attribute 831
- LoadTimeThreshold attribute 831
- loadwarning event trigger 518
- LoadWarningLevel attribute 831
- local attributes 72
- LockMemory attribute 846
- log files 731
- LogClusterUUID attribute 846
- LogDbg attribute 789
- LogFileSize attribute 789
- logging
 - agent log 691
 - engine log 691
 - message tags 691
- logs
 - customizing display in Java Console 169
 - searching from Java Console 168
 - viewing from Java Console 118
- LogSize attribute 846
- Low Latency Transport (LLT) 46

M

- main.cf
 - about 63
 - cluster definition 63
 - group dependency clause 63
 - include clauses 63
 - resource definition 63
 - resource dependency clause 63
 - service group definition 63
 - system definition 63
- ManageFaults attribute 773
 - about 429
 - definition 816
- ManualOps attribute 816
- MemThresholdLevel attribute 831
- message tags
 - about 691
- MeterRecord attribute 831
- MeterWeight attribute 816
- MigrateQ attribute 816

- migrating
 - service groups 215
- MonitorInterval attribute 789
- MonitorMethod attribute 773
- MonitorOnly attribute 773
- MonitorStartParam attribute 789
- MonitorTimeout attribute 789
- MonitorTimeStats attribute 773
- multinicb event trigger 519

N

- N+1 configuration 55
- N-to-1 configuration 54
- N-to-N configuration 56
- Name attribute 773
- network failure 112
- network links
 - detecting failure 660
- networks
 - detecting failure 662
- NoAutoDisable attribute 831
- NodeId attribute 831
- nofailover event trigger 520
- notification
 - about 499
 - deleting messages 501
 - error messages 501
 - error severity levels 501
 - event triggers 515
 - hanotify utility 503
 - message queue 501
 - notifier process 502
 - setting using wizard 166
 - SNMP files 509
 - troubleshooting 735
- Notifier attribute 846
- notifier process 502
- Notifier Resource Configuration wizard 165
- NumRetries attribute 816
- NumThreads attribute
 - definition 789
 - modifying for performance 654

O

- OfflineMonitorInterval attribute 789
- OfflineTimeout attribute 789
- OfflineWaitLimit attribute 789
- On-Off resource 35

- On-Only resource 35
- OnGrpCnt attribute 831
- OnlineAtUnfreeze attribute 816
- OnlineClass attribute 789
- OnlinePriority attribute 789
- OnlineRetryInterval attribute 816
- OnlineRetryLimit attribute
 - for resource types 789
 - for service groups 816
- OnlineTimeout attribute 789
- OnlineWaitLimit attribute 789
- Open IMF
 - overview 42
- OpenExternalCommunicationPort attribute 846
- OpenTimeout attribute 789
- Operations attribute 789
- OperatorGroups attribute
 - for clusters 846
 - for service groups 816
- Operators attribute
 - for clusters 846
 - for service groups 816
- overload warning for SGWM 456

P

- PanicOnNoMem attribute 846
- Parallel attribute 816
- passwords
 - changing from Java Console 125
- Path attribute 773
- PathCount attribute 816
- PCVAllowOnline attribute 816
- performance
 - agents 654
 - GAB 653
 - HAD 653
 - impact of VCS 652
 - Java Console 655
 - modifying entry points 654
 - modifying NumThreads attribute 654
 - when a cluster is booted 656
 - when a network link fails 660
 - when a resource comes online 657
 - when a resource fails 658
 - when a resource goes offline 657
 - when a service group comes online 657
 - when a service group fails over 663
 - when a service group goes offline 658
 - when a service group switches over 662

- performance (*continued*)
 - when a system fails 659
 - when a system panics 660
- Persistent resource 35
- PhysicalServer attribute 831
- PolicyIntention attribute 816
- postoffline event trigger 520
- postonline event trigger 521
- Preference attribute 852
- PreferredFencingPolicy attribute 846
- PreOnline attribute 816
- preonline event trigger 521
- PreOnlineTimeout attribute 816
- PreOnlining attribute 816
- Prerequisites attribute 816
- PreSwitch attribute 816
- PreSwitching attribute 816
- Prevention of Concurrency Violation
 - about 433
- PrintMsg attribute 846
- PrintTree attribute 816
- priorities
 - defaults 664
 - ranges 664
 - scheduling 663
 - specifying 664
- Priority attribute 816
- Priority based failover 217
- priority ranges for sched. classes 663
- privileges.. See user privileges
- Probed attribute
 - for resources 773
 - for service groups 816
- ProbesPending attribute 816
- ProcessPriority attribute 846
- ProPCV attribute 816

Q

- quick reopen 662

R

- ReadOnly attribute 846
- Recovering After a Disaster 634
- Remote cluster attributes 848
- Remote Cluster Configuration wizard 600
- Remote Cluster States 758
- remote clusters
 - monitoring from Java Console 113

- Remove remote cluster 627
- replicated data clusters
 - about 59
- replicated data configuration 59
- resadminwait event trigger 522
- reserved words 73
 - list of 73
- ReservedCapacity attribute 831
- resnotoff event trigger 524
- resource attributes 764
- resource dependencies
 - creating from command line 235
 - creating from Java Console 154
 - displaying from command line 203
 - removing from command line 235
 - removing from Java Console 155
- resource faults
 - clearing from Java Console 153
- resource type attributes 773, 789
- resource types
 - importing 158
 - querying from command line 204
- ResourceInfo attribute
 - clearing from Java Console 157
 - definition 773
 - refreshing from Java Console 157
- ResourceLimit attribute 846
- ResourceOwner attribute 773
- ResourceRecipients attribute 773
- resources
 - about 33
 - adding from command line 222
 - adding from Java Console 144
 - administering from Java Console 144
 - bringing online from command line 236
 - bringing online from Java Console 149
 - categories of 35
 - clearing faults from Java Console 153
 - deleting from command line 223
 - deleting from Java Console 149
 - disabling from command line 448
 - disabling from Java Console 153
 - enabling from command line 217
 - enabling from Java Console 152
 - how disabling affects states 451
 - invoking actions 157
 - limitations of disabling 449
 - linking from command line 235
 - linking from Java Console 154

- resources *(continued)*
 - On-Off 35
 - On-Only 35
 - Persistent 35
 - probing from Java Console 151
 - querying from command line 203
 - taking offline from command line 236
 - taking offline from Java Console 149–150
 - troubleshooting 719
 - unlinking from command line 235
 - unlinking from Java Console 155
- Responding attribute 816
- resrestart event trigger 524
- resstatechange event trigger 525
- Restart attribute 816
- RestartLimit attribute
 - about 440
 - definition 789
- root broker 47

S

- saving a configuration 196
- scalar attribute dimension 70
- scheduling classes 663
 - defaults 664
 - priority ranges 664
- ScriptClass attribute 789
- scripting VCS commands 250
- ScriptPriority attribute 789
- SCSI-3 Persistent Reservations 337
- SecInfo attribute 846
- SecInfoLevel attribute 846
- secure communication 336
- secure mode for clusters
 - disabling 248
 - enabling 248
- secure VCS.. See Veritas Product Authentication Service
- SecureClus attribute 846
- security 335
- server credentials
 - viewing 119
- server-based fencing
 - replacing coordination points
 - online cluster 398
- ServerAvailableCapacity 831
- ServerAvailableForecast 831
- ServerCapacity 831
- ServerReservedCapacity 831

- service group attributes 789
- service group dependencies
 - about 475
 - autorestart 421
 - benefits of 475
 - creating 495
 - creating from Java Console 138
 - limitations of 479
 - manual switch 497
 - removing from Java Console 139
- service group workload management
 - Capacity and Load attributes 455
 - load policy 424
 - load-based autostart 429
 - overload warning 456
 - sample configurations 458
 - SystemZones attribute 428
- service groups
 - adding from command line 211
 - adding from Java Console 127
 - administering from command line 210
 - administering from Java Console 127
 - autoenabling from Java Console 136
 - bringing online from command line 213
 - bringing online from Java Console 131
 - creating using configuration wizard 141
 - deleting from command line 211
 - deleting from Java Console 130
 - disabling from Java Console 136
 - displaying dependencies from command line 202
 - enabling from Java Console 135
 - flushing from command line 219
 - flushing from Java Console 137
 - freezing from command line 216
 - freezing from Java Console 134
 - linking from Java Console 138
 - migrating 215
 - querying from command line 201–202
 - switching from command line 215
 - switching from Java Console 133
 - taking offline from Java Console 132
 - taking remote groups offline 610
 - troubleshooting 713
 - unfreezing from command line 216
 - unfreezing from Java Console 135
 - unlinking from Java Console 139
- Settings 553
- shared nothing configuration 59
- shared storage/replicated data configuration 59
- ShutdownTimeout attribute 831
- Signaled attribute 773
- Simulator.. See VCS Simulator
- SiteAware attribute 846
- sites
 - troubleshooting 721
- SNMP 499
 - files for notification 509
 - HP OpenView 509
 - merging events with HP OpenView NNM 509
 - supported consoles 499
- SourceFile attribute
 - for clusters 846
 - for resource types 789
 - for service groups 816
 - for systems 831
- split-brain
 - in global clusters 564
- ssh configuration for Java Console 93
- Start attribute 773
- State attribute
 - for resources 773
 - for service groups 816
- Statistics attribute 846
- steward process
 - about 564
- Stewards attribute 846
- string attribute type 69
- SupportedActions attribute 789
- SupportedOperations attribute 789
- symmetric configuration 53
- SysDownPolicy attribute 816
- SysInfo attribute 831
- sysjoin event trigger 527
- SysName attribute 831
- sysoffline event trigger 526
- SysState attribute 831
- system attributes 816
- system states 760
- SystemList attribute 852
 - about 66, 212
 - definition 816
 - modifying 212
- SystemLocation attribute 831
- SystemOwner attribute 831
- SystemRebootAction attribute 846
- SystemRecipients attribute 831
- systems
 - adding from command line 244

systems *(continued)*

- adding from Java Console 159
 - administering from command line 240
 - administering from Java Console 159
 - client process failure 660
 - deleting from Java Console 160
 - detecting failure 659
 - displaying node ID from command line 241
 - freezing from Java Console 160
 - panic 660
 - quick reopen 662
 - removing from command line 244
 - states 760
 - unfreezing from Java Console 161
- systems and nodes 31
- SystemZones attribute 816
- sysup event trigger 527

T

- Tag attribute 816
- target selection 424
- TargetCount attribute 816
- templates
 - accessing Template View 114
 - adding resources from 146
 - adding service groups from 129
- TFrozen attribute
 - for service groups 816
 - for systems 831
- ToleranceLimit attribute 789
- ToQ attribute 816
- TriggerEvent attribute
 - for resources 773
 - for service groups 816
- TriggerPath attribute
 - for resources 773
 - for service groups 816
- TriggerResFault attribute 816
- TriggerResRestart attribute
 - for resources 773
 - for service groups 816
- TriggerResStateChange attribute
 - for resources 773
 - for service groups 816
- triggers.. *See* event triggers
- TriggersEnabled attribute
 - for resources 773
 - for service groups 816

troubleshooting

- license keys 739
- logging 691
- notification 735
- resources 719
- service groups 713
- sites 721
- VCS startup 709
- TRSE attribute 831
- TypeDependencies attribute 816
- TypeLimit attribute 846
- TypeOwner attribute 789
- TypeRecipients attribute 789
- types.cf 63

U

- umask
 - setting for VCS files 77
- unable_to_restart_had trigger 527–528
- UnSteadyCount attribute 816
- UpDownState attribute 831
- upgrade main.cf 427
- UseFence attribute 846
- user credentials
 - viewing 119
- user privileges
 - about 82
 - assigning from command line 199–200
 - changing from Java Console 126
 - Cluster Administrator 83
 - Cluster Guest 83
 - Cluster Operator 83
 - for specific commands 746
 - Group Administrator 83
 - Group Operator 83
 - removing from command line 199–201
- UserAssoc attribute 816
- UserInt attribute 831
- UserIntGlobal attribute 816
- UserIntLocal attribute 816
- UserNames attribute 846
- users
 - adding from Java Console 124
 - deleting from command line 201
 - deleting from Java Console 124
 - displaying from command line 201
- UserStrGlobal attribute 816
- UserStrLocal attribute 816

utilities

- hanotify 503
- vxkeyless 180
- vxlicinst 180

Utilization 773

V

VCS

- accessibility 853
- additional considerations for stopping 193
- assistive technology support 854
- event triggers 515
- logging 691
- logging off of 194
- logging on to 194
- notification 499
- querying from command line 201
- SNMP and SMTP 499
- starting from command line 189
- starting with -force 189
- stopping from command line 191
- stopping with other options 192
- stopping without -force 191
- troubleshooting resources 719
- troubleshooting service groups 713
- troubleshooting sites 721

VCS agent statistics 667

VCS attributes 69

VCS Authentication Service
viewing credentials 119

VCS Simulator

- description of 252
- simulating cluster faults from command line 305

VCSFeatures attribute

- for clusters 846
- for systems 831

VCSMode attribute 846

vector attribute dimension 70

Veritas Product Authentication Service

- about 47
- authentication broker 47
- root broker 47

version information

retrieving 244

violation event trigger 528

Virtual Business Services

- features 529
- overview 529
- sample configuration 530

virtual fire drill

about 299

vxfen.. See fencing module

vxkeyless utility 180

vxlicinst utility 180

W

wac 559

WACPort attribute 846

wide-area connector 559

wide-area failover 60

VCS agents 561

Wide-Area Heartbeat agent 560

wizards

Notifier Resource Configuration 165

Remote Cluster Configuration 600